

FIRST CIRCUIT MARK
(NOT SHOWING ON 2
AND 3 CIRCUITS SERIES)

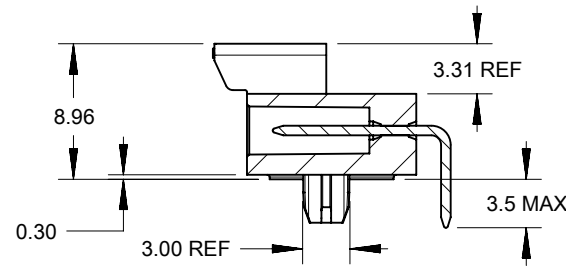

SECTION Y-Y

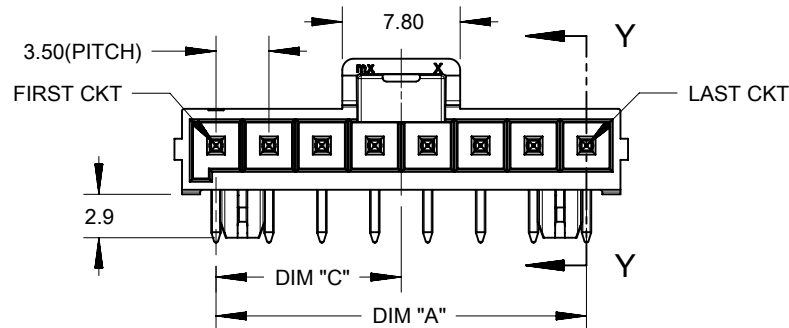
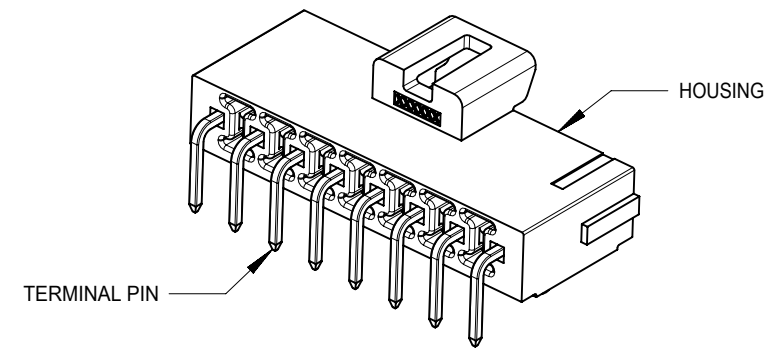
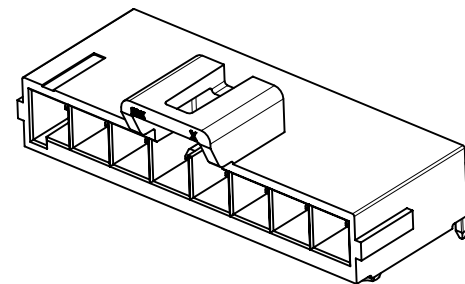
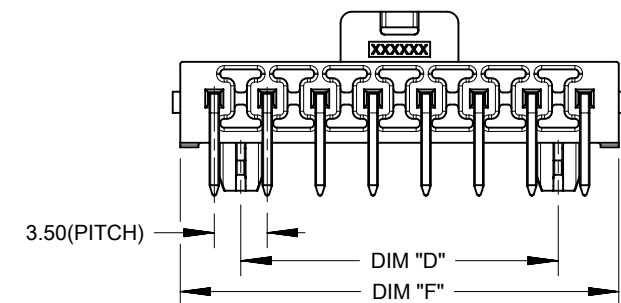

NOTES:

- MATERIAL :
HOUSING
OPTION 1: LCP BLACK, UL94 V-0
OPTION 2: LCP NATURAL, UL94 V-0
TERMINAL: COPPER ALLOY
- PLATING FINISH:
OPTION 1 - 1.5µm(60µin)-2.5µm(100µin) TIN OVER
1.25µm(50µin)-2.5µm(100µin) NICKEL OVERALL
OPTION 2 - 0.35µm(15µin) GOLD CONTACT AREA,
1.5µm(60µin)-2.5µm(100µin) TIN TAIL AREA OVER
1.25µm(50µin)-2.5µm(100µin) NICKEL OVERALL
OPTION 3 - 0.70µm(30µin) GOLD CONTACT AREA,
1.5µm(60µin)-2.5µm(100µin) TIN TAIL AREA OVER
1.25µm(50µin)-2.5µm(100µin) NICKEL OVERALL
- PARTS TO BE PACKAGED PER PK-172310-9001
- PRODUCT SPECIFICATION PS-172323-0001
- PART MATES WITH MOLEX RECEPTACLE HOUSING 172256 AND 172260
- PART CONFORMS TO CLASS "C" REQUIREMENTS OF SPECIFICATION PS-45499-002 WITH 0.13 MM MAXIMUM FLASH ALLOWED IN CORE HOLES AND FRONT SURFACE.
- DISCOLORATION IN THE BANDOLIER AREA OF THE PIN IS INHERENT TO THE PLATING PROCESS AND IS DUE TO THE MASKING EFFECT OF THE CARRIER. THIS DISCOLORATION IS IN A NON-FUNCTIONAL AREA OF THE PIN AND WILL NOT AFFECT THE PERFORMANCE OF THE HEADER ASSEMBLY.
- ASSEMBLY SPECIFICATION: AS-172323-0001

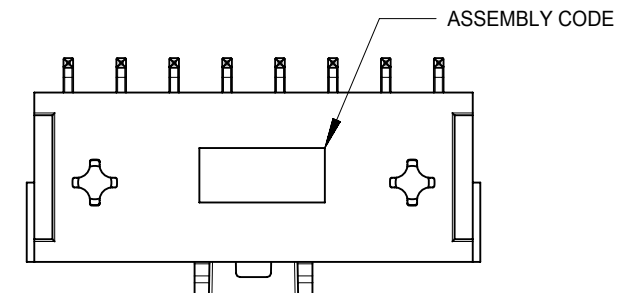
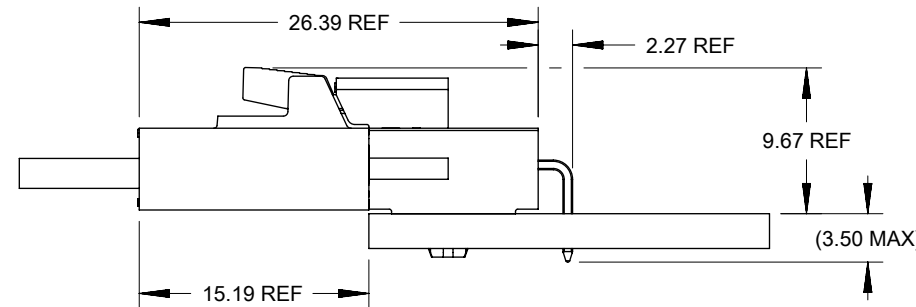

FUNCTIONAL SYMBOLS	THIS DRAWING CONTAINS INFORMATION THAT IS PROPRIETARY TO MOLEX ELECTRONIC TECHNOLOGIES, LLC AND SHOULD NOT BE USED WITHOUT WRITTEN PERMISSION			
	DIMENSION UNITS	SCALE		
$\nabla_A = 0$	mm			
$\nabla_F = 0$	GENERAL TOLERANCES (UNLESS SPECIFIED)			
$\nabla_E = 0$	ANGULAR TOL ± °			
DIVISIONAL SYMBOLS	4 PLACES ±	EC NO: 704776	2022/04/05	
	3 PLACES ±	DRWN: SUGEEB	2022/05/24	
	2 PLACES ± 0.25	CHK'D: GGA	2022/05/24	
	1 PLACE ± 0.5	APPR: GGA		
	0 PLACES ±	INITIAL REVISION:		
DRAFT WHERE APPLICABLE MUST REMAIN WITHIN DIMENSIONS		DRWN: DROSCA	2014/03/05	
THIRD ANGLE PROJECTION		APPR: JCOMERCI	2014/04/24	
DRAWING		SERIES	DOCUMENT NUMBER	
A3-SIZE		172310	SD-172310-1000	
MATERIAL NUMBER		CUSTOMER	DOC TYPE DOC PART REVISION	
		GENERAL MARKET	PSD 000 C4	
			SHEET NUMBER	
			1 OF 3	

10 9 8 7 6 5 4 3 2 1

F E D C B A

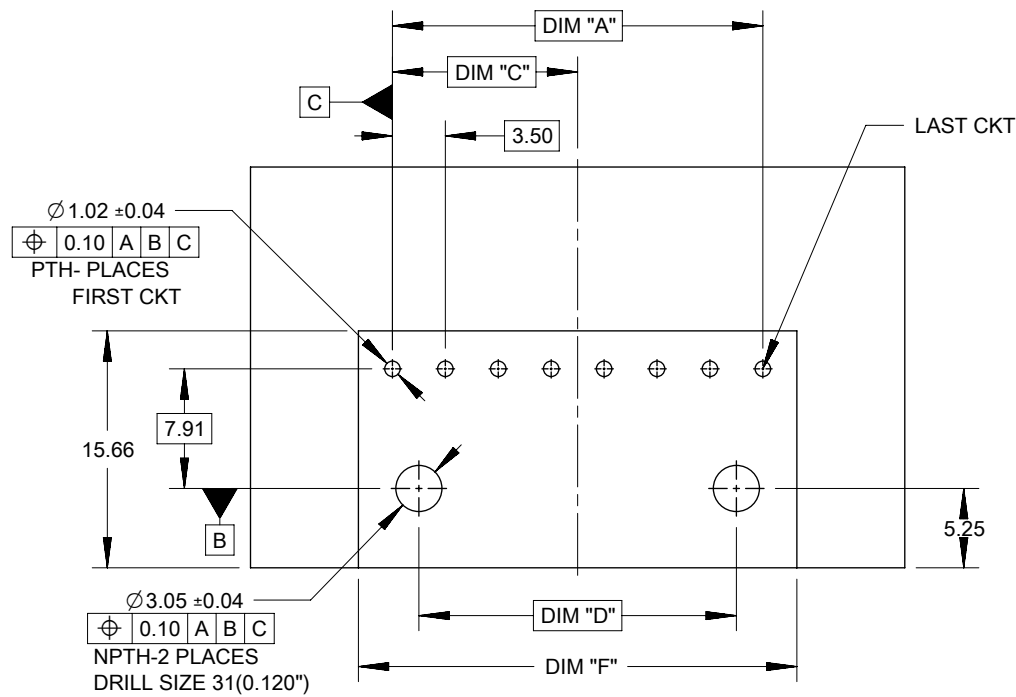

PCB LAYOUT 4,5,6,7 AND 8 COMPONENT SIDE
RECOMENDED PCB THICKNESS 1.60MM-2.40MM

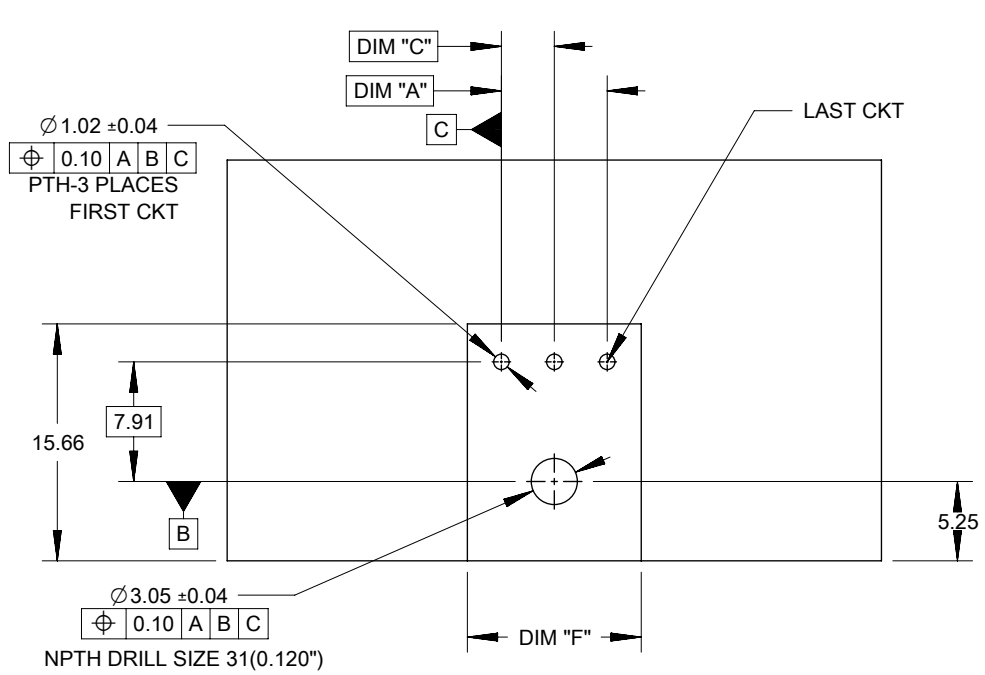

PCB LAYOUT 3 CIRCUIT COMPONENT SIDE
RECOMENDED PCB THICKNESS 1.60MM-2.40MM

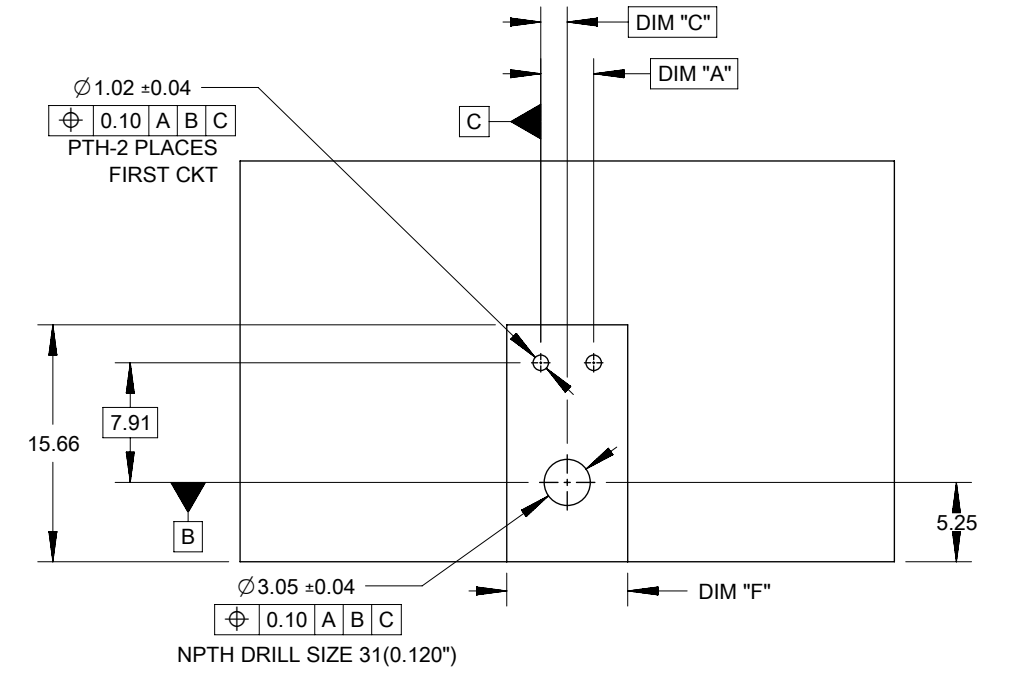

PCB LAYOUT 2 CIRCUIT COMPONENT SIDE
RECOMENDED PCB THICKNESS 1.60MM-2.40MM

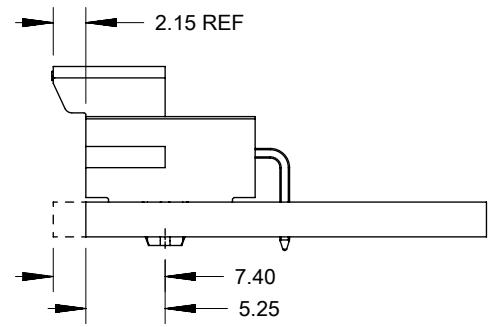

OPTION 1: LATCH FLUSH WITH PCB EDGE
OPTION 2: HOUSING BODY FLUSH WITH PCB EDGE

NOTE: DATUM -A- IS ON PCB COMPONENT SIDE

TIN PLATING							
PART NO.	COLOR	CIRCUIT SIZE	KEY OPTION	DIM A	DIM F	DIM C	DIM D
172310-1102	BLACK	2	KEY A	3.50	8.00	1.75	0.00
172310-1103	BLACK	3	KEY A	7.00	11.50	3.50	0.00
172310-1104	BLACK	4	KEY A	10.50	15.00	5.25	7.00
172310-1105	BLACK	5	KEY A	14.00	18.50	7.00	10.50
172310-1106	BLACK	6	KEY A	17.50	22.00	8.75	14.00
172310-1107	BLACK	7	KEY A	21.00	25.50	10.50	17.50
172310-1108	BLACK	8	KEY A	24.50	29.00	12.25	21.00
172310-2105	NATURAL	5	KEY B	14.00	18.50	7.00	10.50

15 MICROINCH GOLD PLATING							
PART NO.	COLOR	CIRCUIT SIZE	KEY OPTION	DIM A	DIM F	DIM C	DIM D
172310-1202	BLACK	2	KEY A	3.50	8.00	1.75	0.00
172310-1203	BLACK	3	KEY A	7.00	11.50	3.50	0.00
172310-1204	BLACK	4	KEY A	10.50	15.00	5.25	7.00
172310-1205	BLACK	5	KEY A	14.00	18.50	7.00	10.50
172310-1206	BLACK	6	KEY A	17.50	22.00	8.75	14.00
172310-1207	BLACK	7	KEY A	21.00	25.50	10.50	17.50
172310-1208	BLACK	8	KEY A	24.50	29.00	12.25	21.00
172310-2204	NATURAL	4	KEY B	10.50	15.00	5.25	7.00
172310-2205	NATURAL	5	KEY B	14.00	18.50	7.00	10.50
172310-2207	NATURAL	7	KEY B	21.00	25.50	10.50	17.50

30 MICROINCH GOLD PLATING							
PART NO.	COLOR	CIRCUIT SIZE	KEY OPTION	DIM A	DIM F	DIM C	DIM D
172310-1302	BLACK	2	KEY A	3.50	8.00	1.75	0.00
172310-1303	BLACK	3	KEY A	7.00	11.50	3.50	0.00
172310-1304	BLACK	4	KEY A	10.50	15.00	5.25	7.00
172310-1305	BLACK	5	KEY A	14.00	18.50	7.00	10.50
172310-1306	BLACK	6	KEY A	17.50	22.00	8.75	14.00
172310-1307	BLACK	7	KEY A	21.00	25.50	10.50	17.50
172310-1308	BLACK	8	KEY A	24.50	29.00	12.25	21.00
172310-2304	NATURAL	4	KEY B	10.50	15.00	5.25	7.00

DOCUMENT STATUS	P1	RELEASE DATE	2022/05/24	10:34:52
-----------------	----	--------------	------------	----------

FUNCTIONAL SYMBOLS FA = 0 FE = 0 FP = 0	THIS DRAWING CONTAINS INFORMATION THAT IS PROPRIETARY TO MOLEX ELECTRONIC TECHNOLOGIES, LLC AND SHOULD NOT BE USED WITHOUT WRITTEN PERMISSION		CURRENT REV DESC: OBSOLETE PART NUMBER AS PER PCN#509988					
	DIMENSION UNITS: mm		SCALE:					
	GENERAL TOLERANCES (UNLESS SPECIFIED)							
	ANGULAR TOL ± °							
DIVISIONAL SYMBOLS	4 PLACES ±	EC NO: 704776	2022/04/05		PRODUCT CUSTOMER DRAWING SD-172310-1000 PSD 000 C4			
	3 PLACES ±	DRWN: SUGEEB	2022/05/24					
	2 PLACES ± 0.25	CHK'D: GGA	2022/05/24					
	1 PLACE ± 0.5	APPR: GGA	2022/05/24					
0 PLACES ±	INITIAL REVISION:	2014/03/05		DOCUMENT NUMBER	DOC TYPE	DOC PART	REVISION	
DRAFT WHERE APPLICABLE MUST REMAIN WITHIN DIMENSIONS		DRWN: DROSCA	2014/04/24		SD-172310-1000	PSD	000	C4
THIRD ANGLE PROJECTION		APPR: JCOMERCI	2014/04/24		MATERIAL NUMBER		CUSTOMER	
DRAWING		SERIES		SHEET NUMBER		GENERAL MARKET		2 OF 3
A3-SIZE		172310						

9 8 7 6 5 4 3 2 1

10

9

8

7

6

5

4

3

2

1

F

F

E

E

D

D

C

C

B

B

A

A

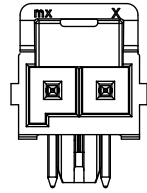

2 CKT

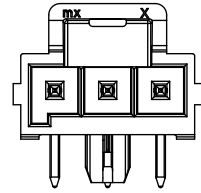

3 CKT

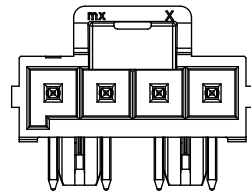

4 CKT

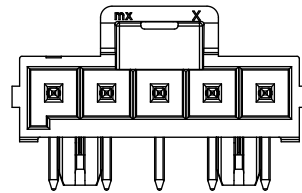

5 CKT

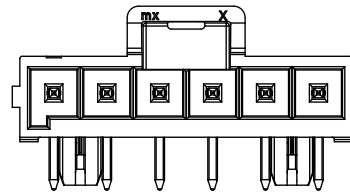

6 CKT

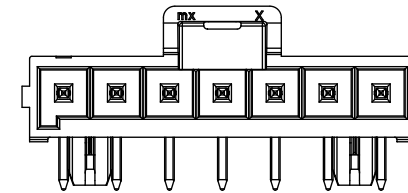

7 CKT

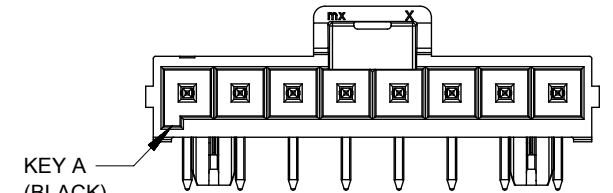

KEY A
(BLACK)

8 CKT

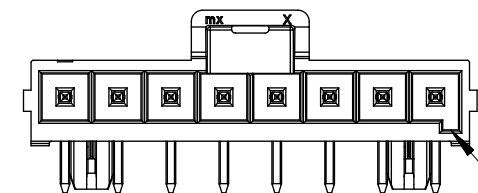

KEY B
(NATURAL)

9

8

7

6

5

4

3

2

1

FUNCTIONAL SYMBOLS	THIS DRAWING CONTAINS INFORMATION THAT IS PROPRIETARY TO MOLEX ELECTRONIC TECHNOLOGIES, LLC AND SHOULD NOT BE USED WITHOUT WRITTEN PERMISSION						
	$\nabla_A = 0$ $\nabla_F = 0$ $\nabla_P = 0$	DIMENSION UNITS: mm SCALE:				CURRENT REV DESC: OBSOLETE PART NUMBER AS PER PCN#509988 EC NO: 704776 DRWN: SUGEEB 2022/04/05 CHK'D: GGA 2022/05/24 APPR: GGA 2022/05/24	ULTRA-FIT R/A HEADER 2-8 CKTS SINGLE ROW
DIVISIONAL SYMBOLS	GENERAL TOLERANCES (UNLESS SPECIFIED)		PRODUCT CUSTOMER DRAWING				
	ANGULAR TOL ± °		DOCUMENT NUMBER				
	4 PLACES ±	3 PLACES ±	SD-172310-1000				
	2 PLACES ± 0.25	1 PLACE ± 0.5	DOC TYPE	DOC PART	REVISION		
0 PLACES ±	INITIAL REVISION:		PSD 000 C4				
DRAFT WHERE APPLICABLE MUST REMAIN WITHIN DIMENSIONS		THIRD ANGLE PROJECTION	DRAWING	SERIES	MATERIAL NUMBER	CUSTOMER	SHEET NUMBER
			A3-SIZE	172310		GENERAL MARKET	3 OF 3

FORMAT: master-ib-prod-A3

REVISION: 11

DATE: 2021/05/01