



Electrical Specifications

Cutoff Frequency: 168 MHz
Insertion Loss: 1.0 dB Max at DC-168 MHz
Return Loss: 10 dB Min
Stopband: 30 dB at 193 MHz
Ultimate Rejection: 40 dB at 252-840 MHz
Power Handling: 30 W

Mechanical

Connector Type: SMA (F)
Dimensions: 4.0 x 1.25 x 0.75 Inches

Environmental

Operating Temperature: -40 to +85° C
Storage Temperature: -50 to +95° C
Shock: 20 G. 11 ms
Vibration: 20 G. 5 to 200 MHz

Outline Drawing:

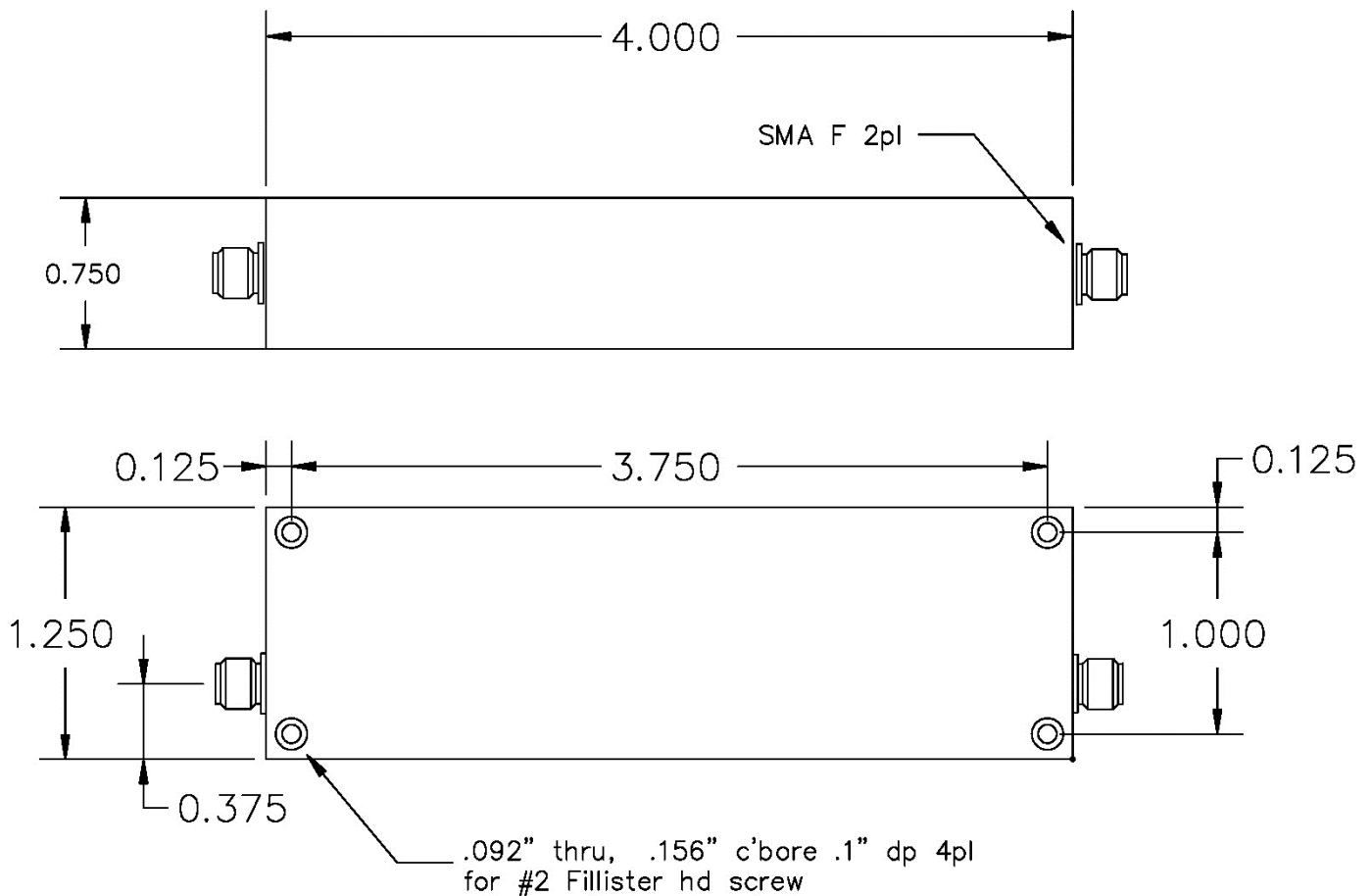



Response Plot:

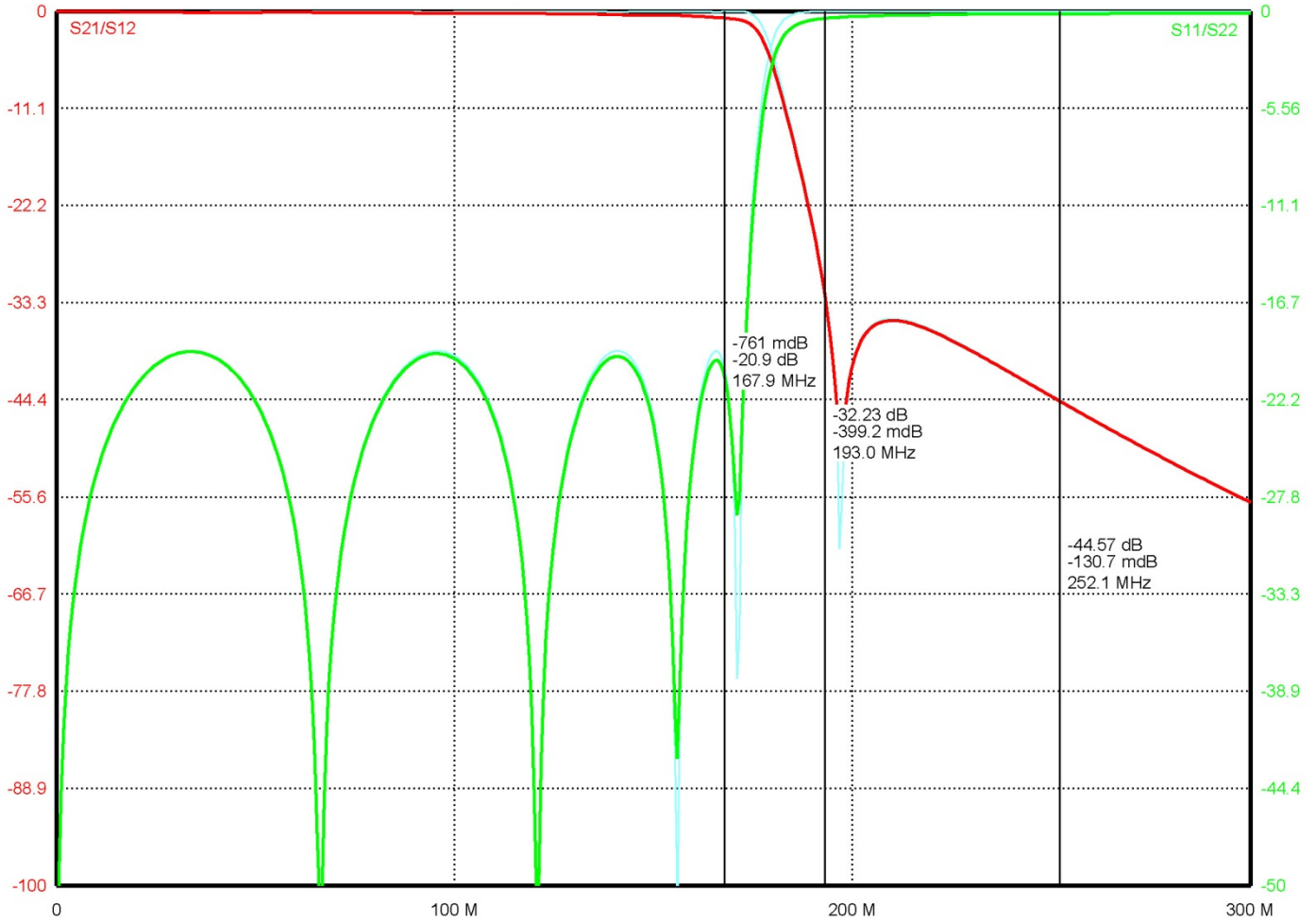

Note: This is a simulation plot. Actual results may differ once the product is implemented.