

XFP-10GB-DW24-100-C

MSA and TAA 10GBase-DWDM 100GHz XFP Transceiver (SMF, 1558.17nm, 100km, LC, DOM)

Features:

- INF-8077i Compliance
- Duplex LC Connector
- Temperature-stabilized EML transmitter and PIN receiver
- Single-mode Fiber
- Commercial Temperature 0 to 70 Celsius
- Hot Pluggable
- Metal with Lower EMI
- Excellent ESD Protection
- RoHS Compliant and Lead Free



Applications:

- 10x Gigabit Ethernet over DWDM
- 8x/10x Fibre Channel
- Access, Metro and Enterprise

Product Description

This MSA Compliant XFP transceiver provides 10GBase-DWDM throughput up to 100km over single-mode fiber (SMF) using a wavelength of 1558.17nm via an LC connector. It is built to MSA standards and is uniquely serialized and data-traffic and application tested to ensure that they will integrate into your network seamlessly. Digital optical monitoring (DOM) support is also present to allow access to real-time operating parameters. This transceiver is Trade Agreements Act (TAA) compliant. We stand behind the quality of our products and proudly offer a limited lifetime warranty.

ProLabs's transceivers are RoHS compliant and lead-free.

TAA refers to the Trade Agreements Act (19 U.S.C. & 2501-2581), which is intended to foster fair and open international trade. TAA requires that the U.S. Government may acquire only "U.S. – made or designated country end products."



Regulatory Compliance

- ESD to the Electrical PINs: compatible with MIL-STD-883E Method 3015.4.
- ESD to the LC Receptacle: compatible with IEC 61000-4-3.
- EMI/EMC: compatible with FCC Part 15 Subpart B Rules, EN55022:2010.
- Laser Eye Safety: compatible with FDA 21CFR, EN60950-1& EN (IEC) 60825-1, 2.
- RoHS: compliant with EU RoHS 2.0 directive 2015/863/EU.

Available Wavelengths

Channel #	Frequency (THz)	Center Wavelength (nm)
15	191.5	1565.50
16	191.6	1564.68
17	191.7	1563.86
18	191.8	1563.05
19	191.9	1562.23
20	192.0	1561.42
21	192.1	1560.61
22	192.2	1559.79
23	192.3	1558.98
24	192.4	1558.17
25	192.5	1557.36
26	192.6	1556.55
27	192.7	1555.75
28	192.8	1554.94
29	192.9	1554.13
30	193.0	1553.33
31	193.1	1552.52
32	193.2	1551.72
33	193.3	1550.92
34	193.4	1550.12
35	193.5	1549.32
36	193.6	1548.51
37	193.7	1547.72
38	193.8	1546.92
39	193.9	1546.12
40	194.0	1545.32
41	194.1	1544.53
42	194.2	1543.73

43	194.3	1542.94
44	194.4	1542.14
45	194.5	1541.35
46	194.6	1540.56
47	194.7	1539.77
48	194.8	1538.98
49	194.9	1538.19
50	195.0	1537.40
51	195.1	1536.61
52	195.2	1535.82
53	195.3	1535.04
54	195.4	1534.25
55	195.5	1533.47
56	195.6	1532.68
57	195.7	1531.90
58	195.8	1531.12
59	195.9	1530.33
60	196.0	1529.55
61	196.1	1528.77

Absolute Maximum Ratings

Parameter	Symbol	Min.	Max.	Unit
Storage Temperature	T _{stg}	-40	85	°C
Operating Temperature	T _c	0	70	°C
Operating Humidity	RH		95	%
Maximum Supply Voltage	V _{cc}	-0.5	3.6	dBm
Maximum Bitrate	B _{max}		11.3	Gbps

Electrical Characteristics

Parameter	Symbol	Min.	Typ.	Max.	Unit	Notes
Power Budget			25		dB	
Data Rate			9.953 10.3125		Gbps	
Transmitter						
CML Differential Inputs	VIN	150		1200	mVp-p	1
Input AC Common-Mode Voltage		0		25	mV	2
Input Differential Impedance	ZIN	85	100	115	Ω	3
Tx_Disable	High		2		Vcc	V
	Low		0		0.8	V
Tx_Fault	High		2		Vcc+0.3	V
	Low		0		0.5	V
Receiver						
CML Differential Outputs	VOUT	350		700	mVp-p	6
Output Differential Impedance	ZOUT	85	100	115	Ω	
Rx_LOS	High		2		Vcc+0.3	V
	Low		0		0.8	V
MOD_DEF (0.2)		VOH	2.5			V
		VOL	0		0.5	V

Notes:

1. AC coupled inputs.
2. RMS.
3. $R_{in} > 100k\Omega$ @DC.
4. $I_o = 400\mu A$. Host_Vcc.
5. $I_o = -4.0mA$.
6. AC coupled outputs.
7. With serial ID.

Optical Characteristics

Parameter	Symbol	Min.	Typ.	Max.	Unit	Notes
Transmitter						
Operating Wavelength	λ_C	$\lambda_C-0.1$	λ_C	$\lambda_C+0.1$	nm	
Spectral Width (-20dB)	$\Delta\lambda$			1	nm	
Average Output Power	POUT	1		5	dBm	1
Extinction Ratio	ER	8.2			dB	
Average Power of Off Transmitter	Poff			-30	dBm	
Relative Intensity Noise	RIN			-128	dB/Hz	
Side-Mode Suppression Ratio	SMSR	30			dB	
Transmitter Dispersion Penalty	TDP			5	dB	
Tx_Disable Assert Time	T_off			10	us	
Receiver						
Center Wavelength	λ_C	1260	1550	1600	nm	
Receiver Sensitivity	Pmin			-24	dBm	2
Receiver Overload	Pmax	-7			dBm	
LOS De-Assert	LOSD			-26	dBm	
LOS Assert	LOSA	-38			dBm	
LOS Hysteresis	LOSH	0.5			dB	

Notes:

1. Output is coupled into a 9/125 μ m SMF.
2. Measured with worst ER: BER < 1E⁻¹² and PRBS 2³¹-1 @ 10.3125Gbps.

Pin Descriptions

Pin	Symbol	Name/Description	Note
1	GND	Module Ground.	
2	Vee5	Optional. 5.2 Power Supply. Not Required.	
3	MOD_DESEL	Module De-Select. When held "low," allows the module to respond to 2-wire serial interface commands.	
4	Interrupt	Interrupt Output. Indicates the presence of an important condition which can be read over the 2-wire serial interface.	
5	Tx_Disable	Transmitter Disable. Transmitter laser source is turned off.	
6	Vcc5	+5 Power Supply. Not Required.	
7	GND	Module Ground.	
8	Vcc3	+3.3V Power Supply.	
9	Vcc3	+3.3V Power Supply.	
10	SCL	2-Wire Serial Interface Clock.	
11	SDA	2-Wire Serial Interface Data.	
12	MOD_ABS	Module Absent. Indicates that the module is not present. Grounded in the module.	
13	MOD_NR	Module is Not Ready.	
14	Rx_LOS	Receiver Loss of Signal Indicator.	
15	GND	Module Ground.	
16	GND	Module Ground.	
17	RD-	Receiver Inverted Data Output.	
18	RD+	Receiver Non-Inverted Data Output.	
19	GND	Module Ground.	
20	Vcc2	+1.8V Power Supply. Not Required.	
21	P_Down/RST	Power Down. When "high," places the module in the low-power stand-by mode. The falling edge of P_Down initiates a module reset. Reset. The falling edge initiates a complete reset of the module including the 2-wire serial interface equivalent to a power cycle.	
22	Vcc2	+1.8V Power Supply. Not Required.	
23	GND	Module Ground.	
24	Ref CLK+	Reference Clock. Non-Inverted Input. AC coupled on the host board. Not Required.	
25	Ref CLK-	Reference Clock. Inverted Input. AC coupled on the host board. Not Required.	
26	GND	Module Ground.	
27	GND	Module Ground.	
28	TD-	Transmitter Inverted Data Input.	
29	TD+	Transmitter Non-Inverted Data Input.	
30	GND	Module Ground.	

Electrical Pin-Out Details

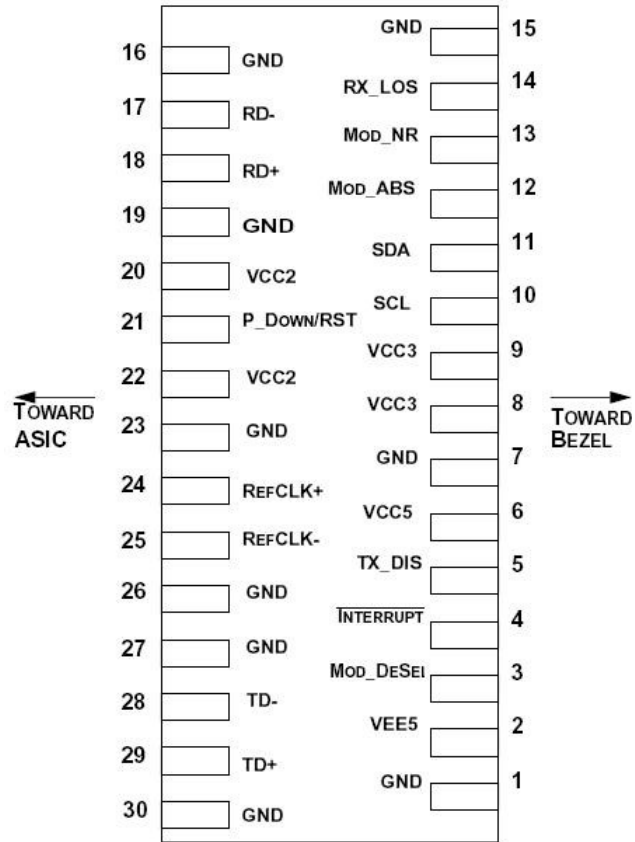

Recommended Circuit Schematic

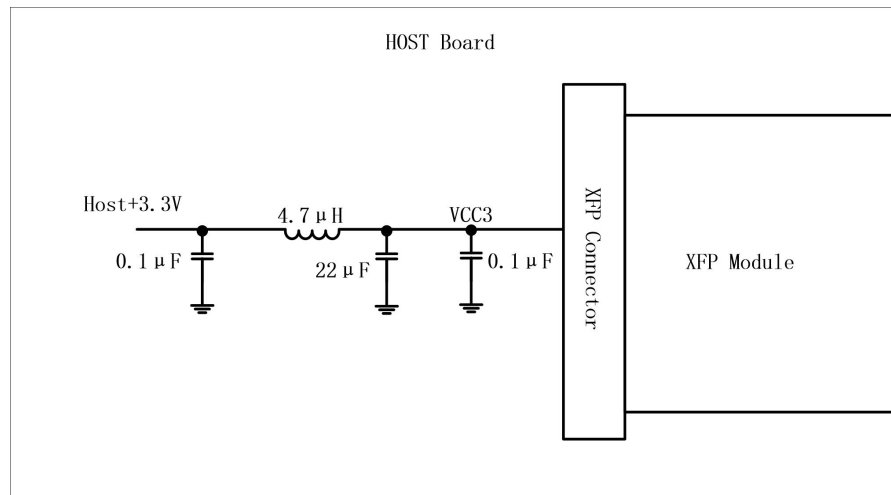

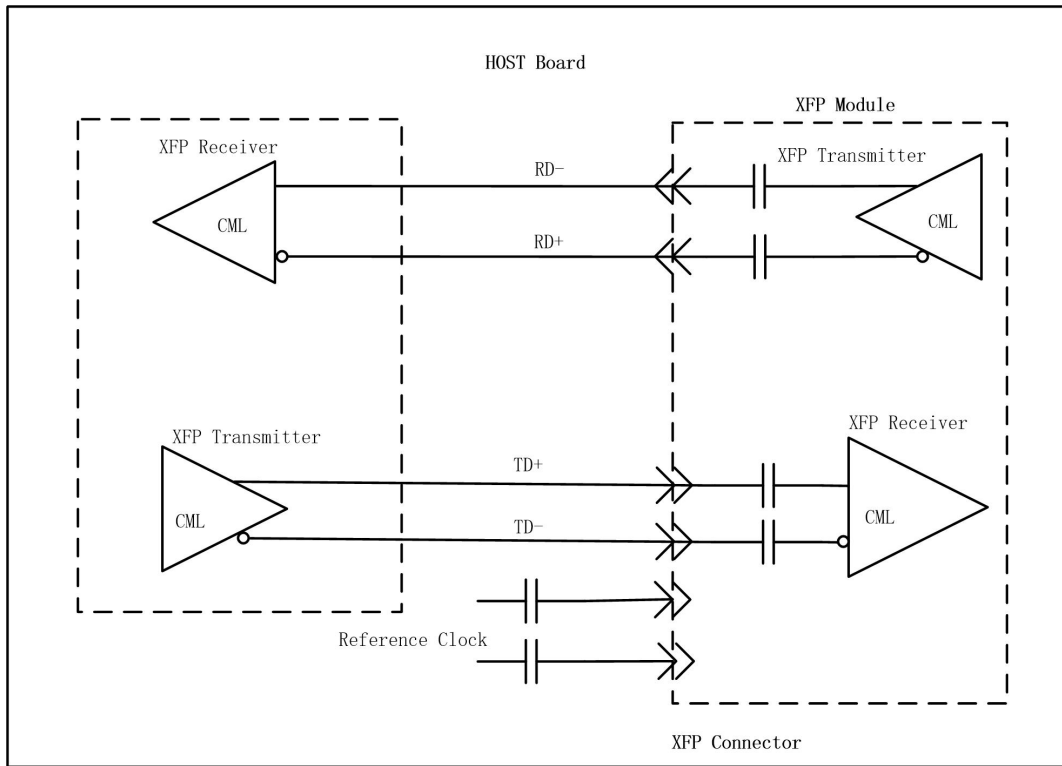

Mechanical Specifications

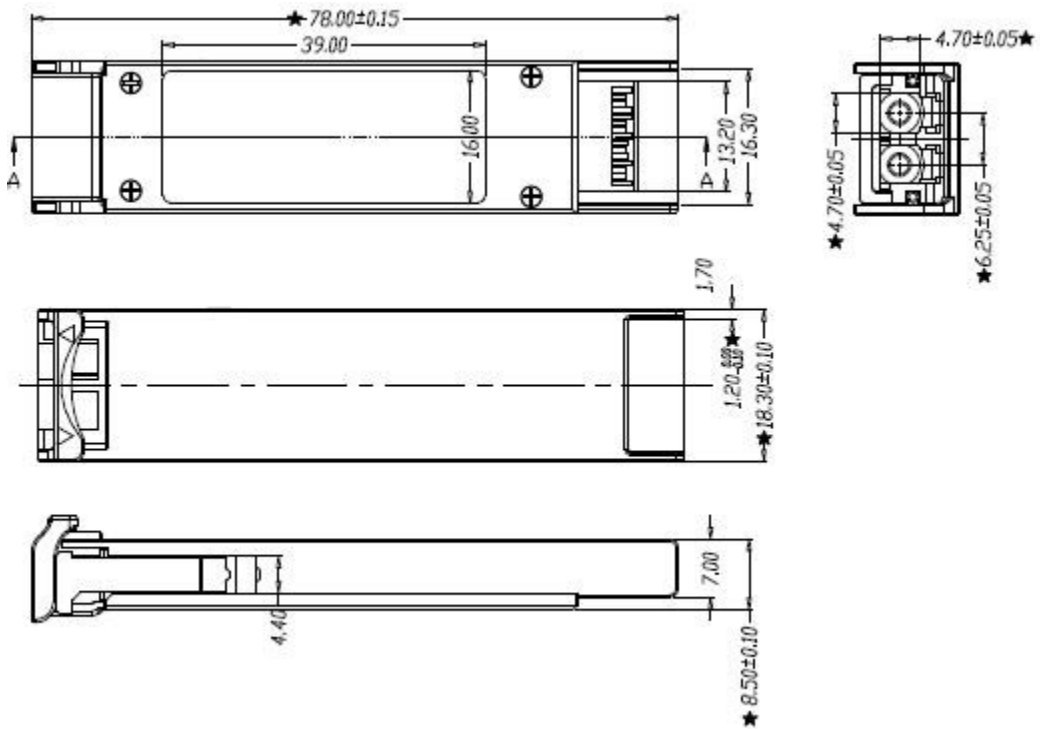

About ProLabs

Our experience comes as standard; for over 15 years ProLabs has delivered optical connectivity solutions that give our customers freedom and choice through our ability to provide seamless interoperability. At the heart of our company is the ability to provide state-of-the-art optical transport and connectivity solutions that are compatible with over 90 optical switching and transport platforms.

Complete Portfolio of Network Solutions

ProLabs is focused on innovations in optical transport and connectivity. The combination of our knowledge of optics and networking equipment enables ProLabs to be your single source for optical transport and connectivity solutions from 100Mb to 400G while providing innovative solutions that increase network efficiency. We provide the optical connectivity expertise that is compatible with and enhances your switching and transport equipment.

Trusted Partner

Customer service is our number one value. ProLabs has invested in people, labs and manufacturing capacity to ensure that you get immediate answers to your questions and compatible product when needed. With Engineering and Manufacturing offices in the U.K. and U.S. augmented by field offices throughout the U.S., U.K. and Asia, ProLabs is able to be our customers best advocate 24 hours a day.

Contact Information

ProLabs US

Email: sales@prolabs.com

Telephone: 952-852-0252

ProLabs UK

Email: salessupport@prolabs.com

Telephone: +44 1285 719 600