

SPECIFICATION

- Part No. : **IS.05.B.301111**
- Product Name : 915MHz Hercules ISM Band Antenna
Screw-mount (Permanent mount)
- Features : Low Profile
Height: 29mm, Diameter: 49mm
Heavy Duty Screw Mount
UV and Vandal Resistant PC Housing
IP67 & IP69K – Waterproof
Standard cable is 3m RG174 with SMA(M)-
connector fully customizable
ROHS & REACH Compliant



1. INTRODUCTION

The 915MHz Hercules ISM Antenna is a high performance steel thread-mount ISM antenna for external use on vehicles and outdoor assets worldwide. Omni-directional high gain across all bands ensures constant reception and transmission. Durable UV resistant PC housing is resistant to vandalism and direct attack. At only 29 mm height it complies with the latest EU height restrictions directives for roof-mounted objects, with a diameter of 52 mm. Designed to not catch on tree-branches. The antenna can be mounted on metal structures.

2. SPECIFICATION

ELECTRICAL					
Standard	ISM				
Band (MHz)	915				
Frequency (MHz)	902-928				
Cable Length (m)	0.3	1.0	2.0	3.0	5.0
Return Loss (dB)	-13.68	-13.86	-15.16	-14.61	-17.54
Efficiency (%)	27.49	44.13	38.36	27.09	21.10
Gain (dBi)	1.15	2.75	3.14	1.85	0.25
Polarization	Linear				
Impedance	50 ohms				
Max Input Power	10 watts				
VSWR	<2.5:1				

*Note: The return loss, efficiency and gain in the above table, were measured on 30x30 cm metal plate with RG174 cable. For a specific case performance refers to the below plots.

MECHANICAL	
Dimensions	Height = 29mm and Diameter = 52mm
Cable length	3m RG174 – Fully Customable
Connector	SMA-Male – Fully Customable
Casing	UV Resistant PC
Base and Thread	Nickel plated steel
Thread Diameter	18 mm
Weather proof gasket	Rubber
Sealant	Rubber Stopper
ENVIRONMENTAL	
Corrosion	5% NaCl for 48hrs - Nickel plated steel base and thread
Temperature Range	-40°C to +85°C
Thermal Shock	100 cycles -40°C to +85°C
Humidity	Non-condensing 65°C 95% RH
Shock (Drop Test)	1m drop on concrete 6 axes
Cable Pull	8 Kgf
Recommended Torque Setting for Mounting	24.5N·m
Maximum Torque Setting for Mounting	29.4N·m

*Note: Specifications may be subject to change

3. TEST SET UP



Figure 1. IS.05 Antenna test set up in free space, 30x30cm metal plate and 60x60 cm metal plate, R&SZVL6 VNA (left) and R&S4100 CTIA 3D Chamber (Right).

4. ANTENNA PARAMETERS

4.1 Return Loss

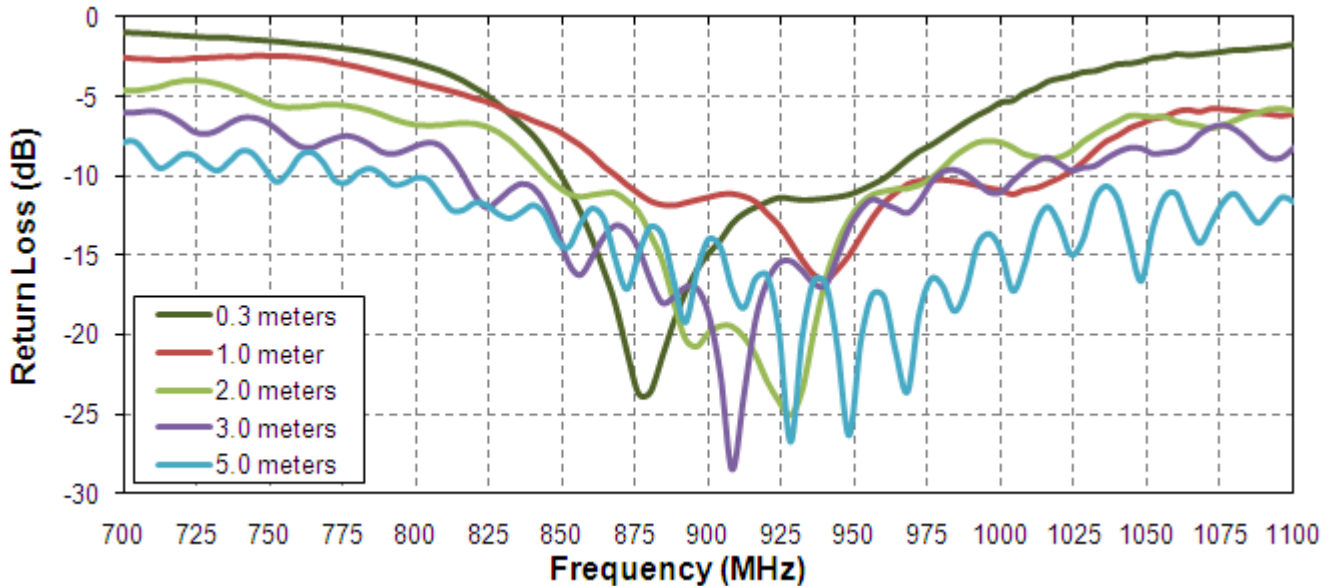

Figure 2. Return Loss of the 915MHz Hercules ISM antenna in free space

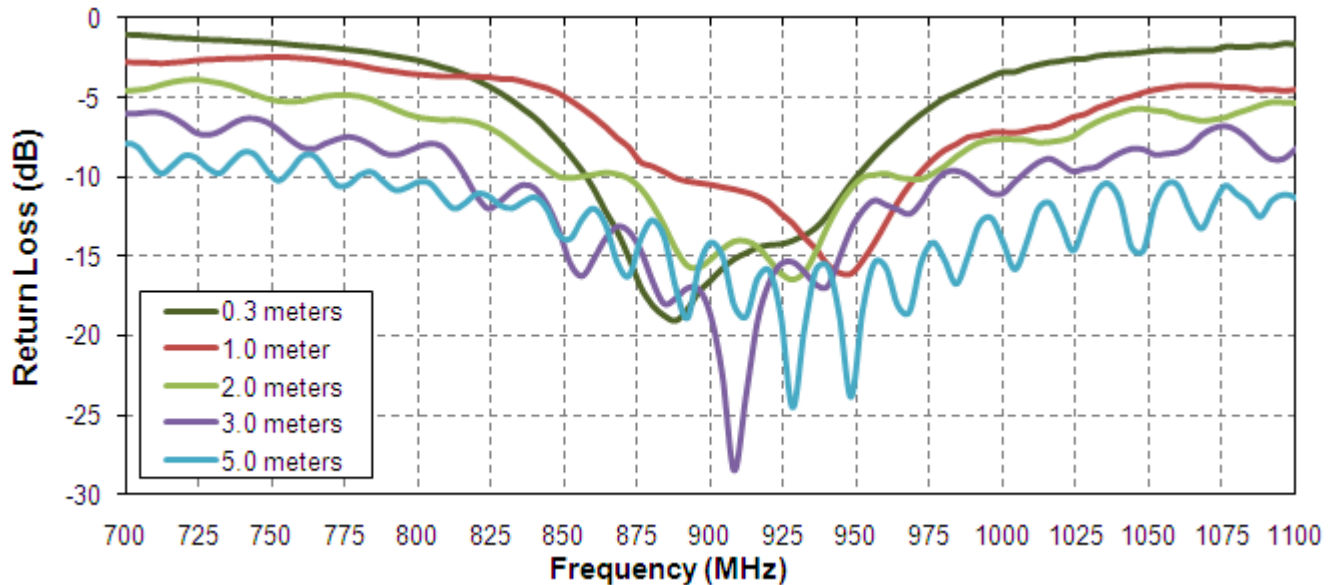

Figure 3. Return loss of the 915MHz Hercules ISM antenna on 30x30 cm metal plate.

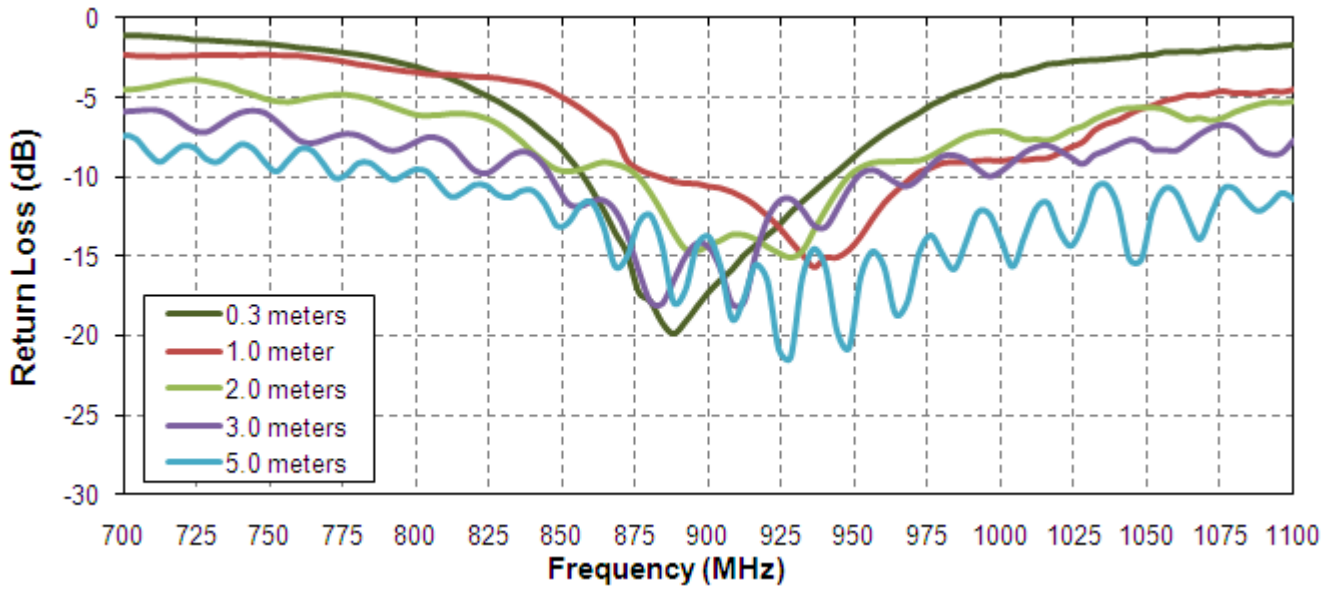

Figure 4. Return loss of the 915Mhz Hercules ISM antenna on 60x60 cm metal plate.

4.2 Efficiency

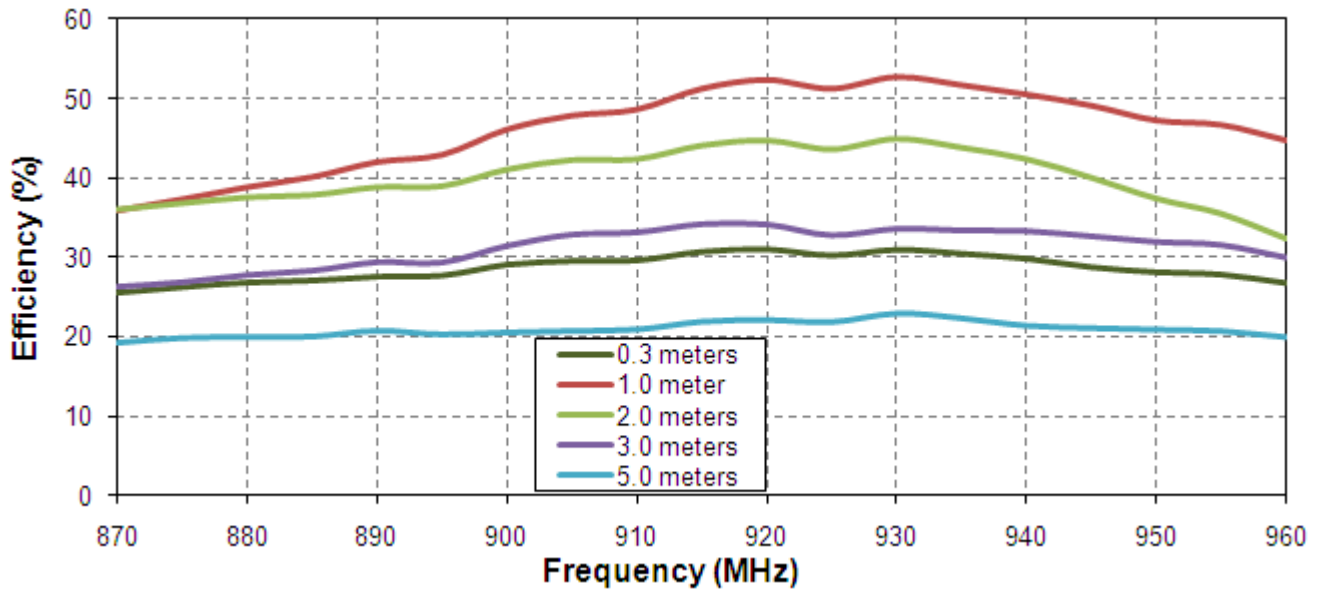

Figure 5. Efficiency of the 915MHz Hercules ISM antenna in free space.

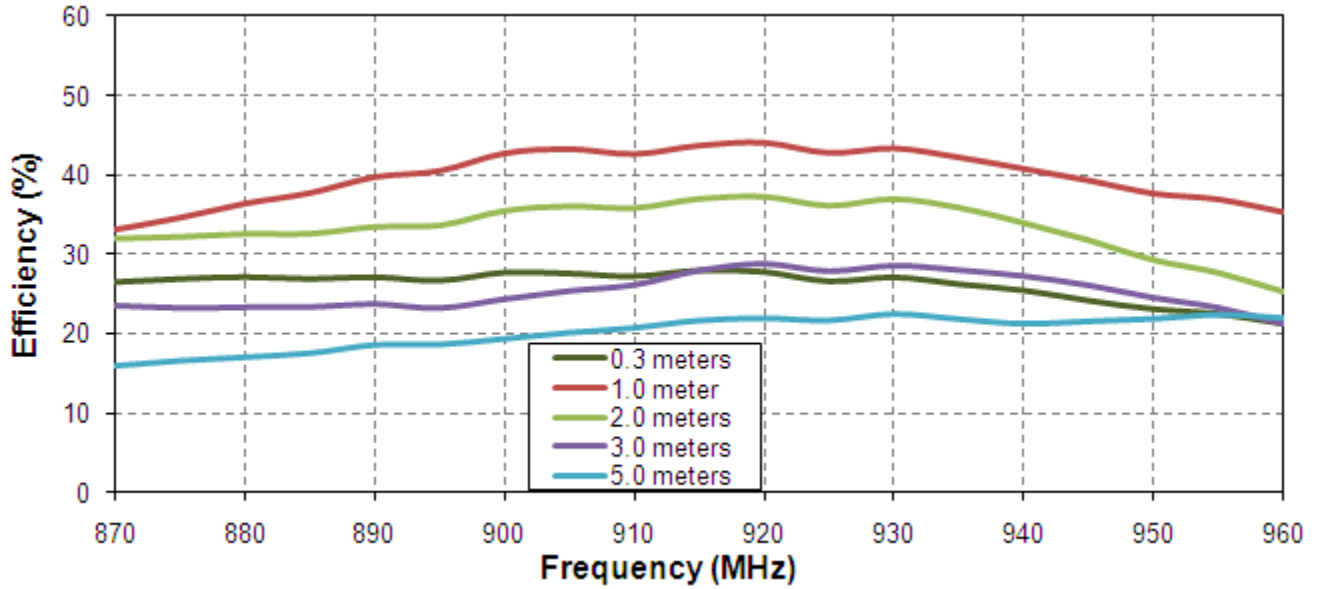

Figure 6. Efficiency of the 915MHz Hercules ISM antenna on 30x30 cm metal plate.

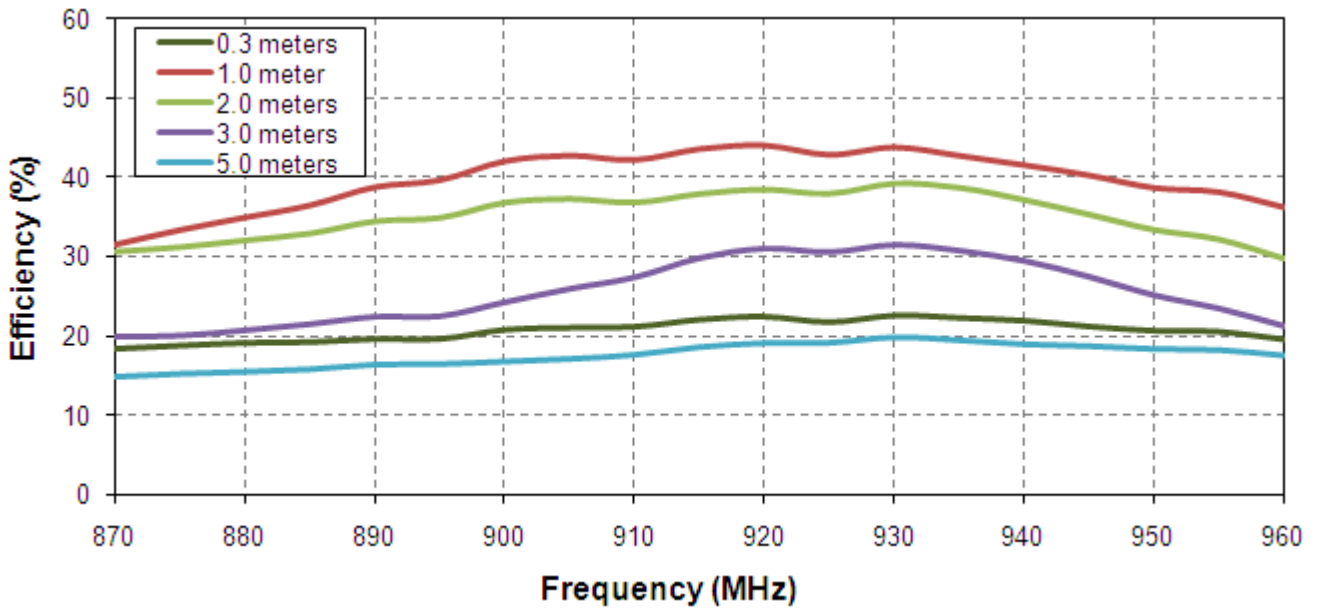

Figure 7. Efficiency of the 915MHz Hercules ISM antenna on 60x60 cm metal plate.

4.3 Gain

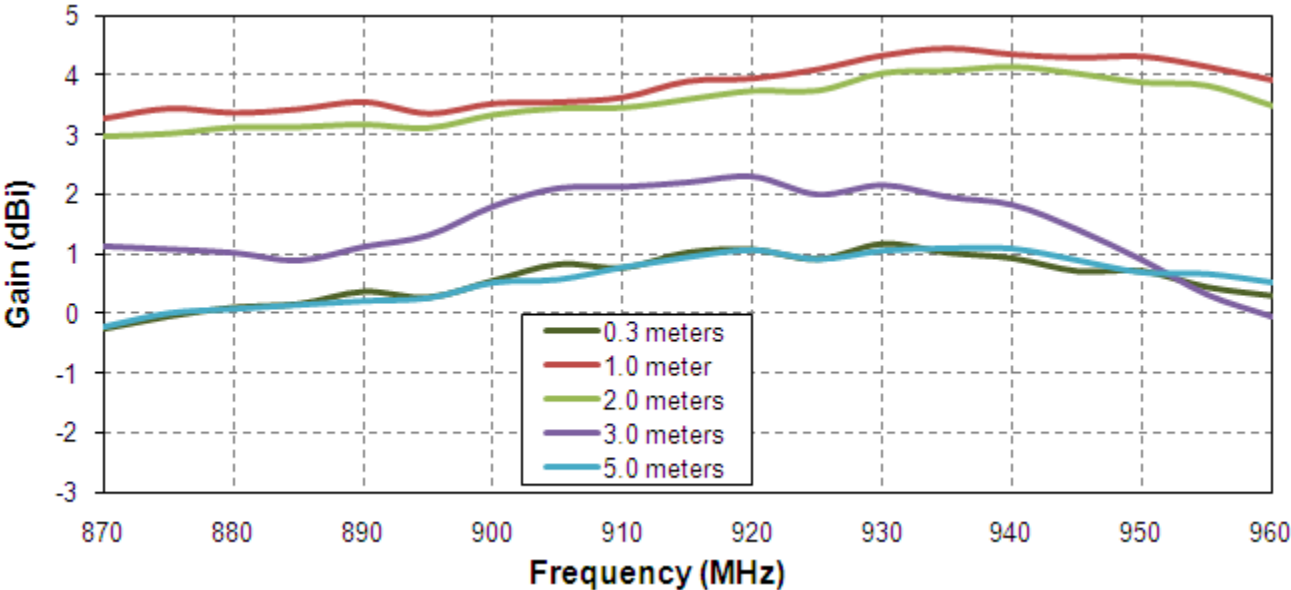

Figure 8. Gain of the 915MHz Hercules ISM antenna in free space.

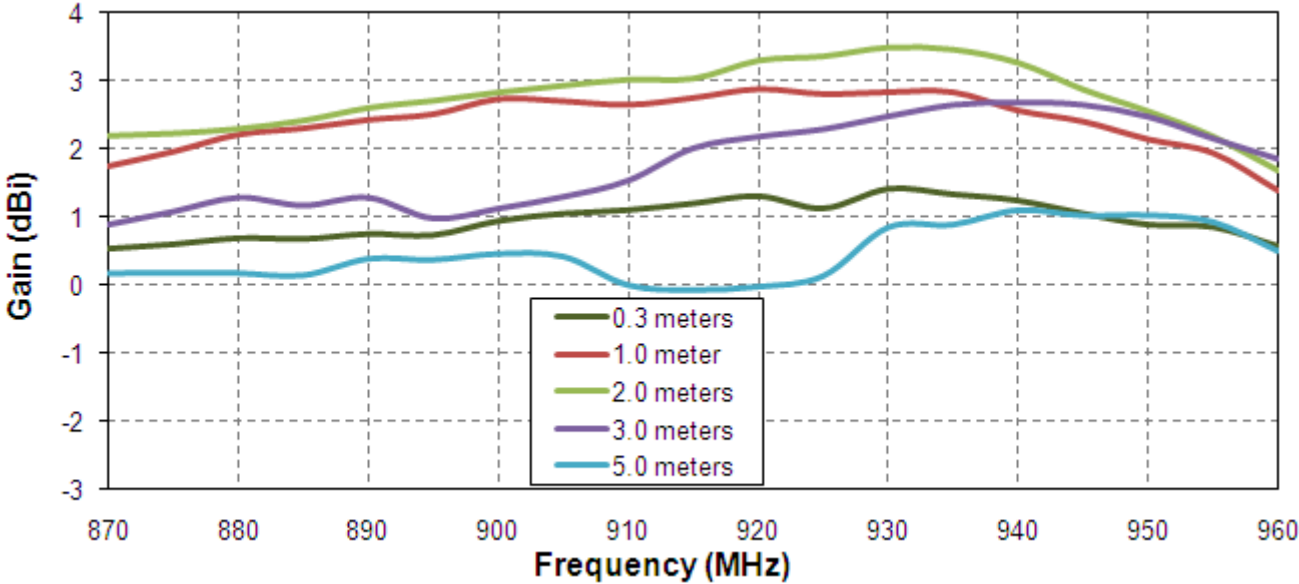

Figure 9. Gain of the 915MHz Hercules ISM antenna on 30 cm metal plate.

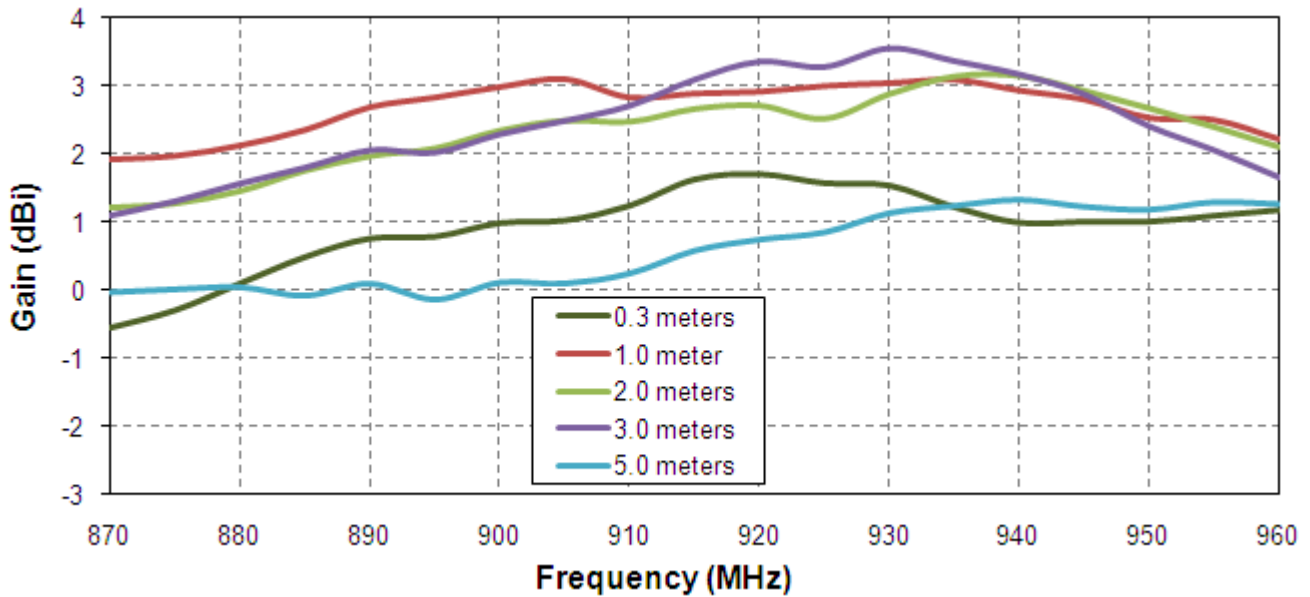

Figure 10. Gain of the 915MHz Hercules ISM antenna on 60 cm metal plate.

4.4. Radiation Pattern

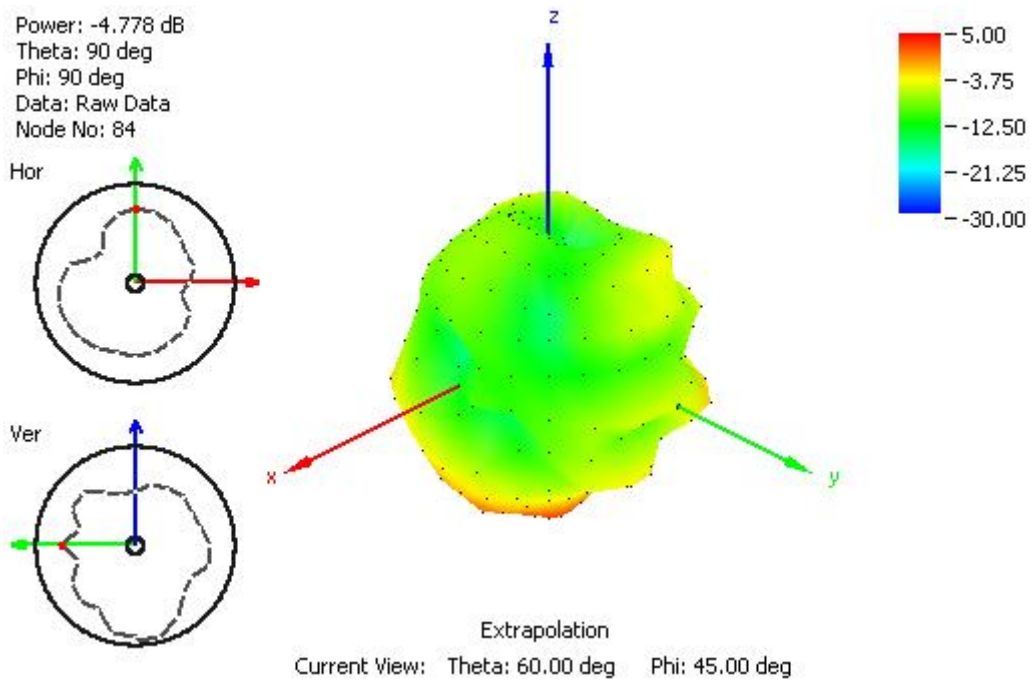

Figure 11. Radiation pattern at 900 MHz, Figure 1 as reference (dB), with 2m RG174 cable and free space.

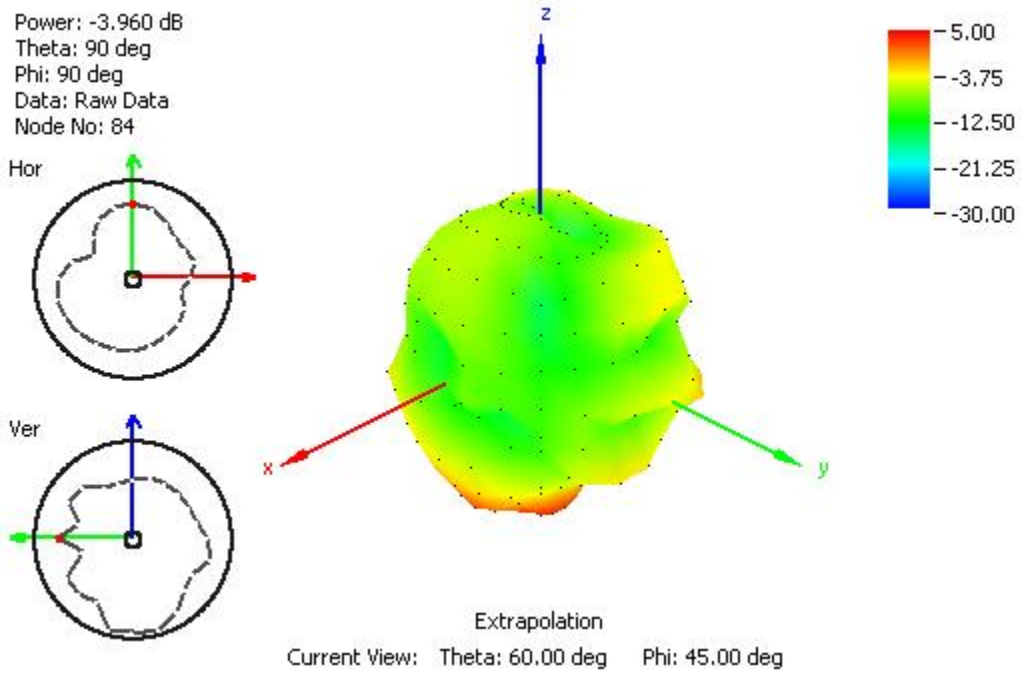

Figure 12. Radiation pattern at 915 MHz, Figure 1 as reference (dB), with 2m RG174 cable and free space.

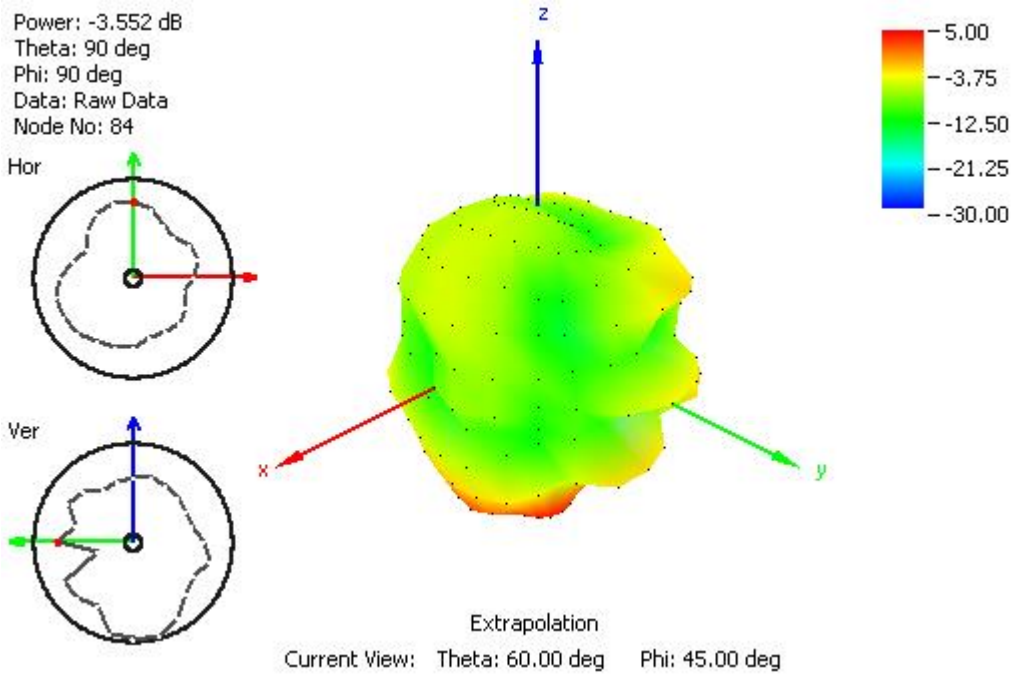

Figure 13. Radiation pattern at 930 MHz, Figure 1 as reference (dB), with 2m RG174 cable free space.

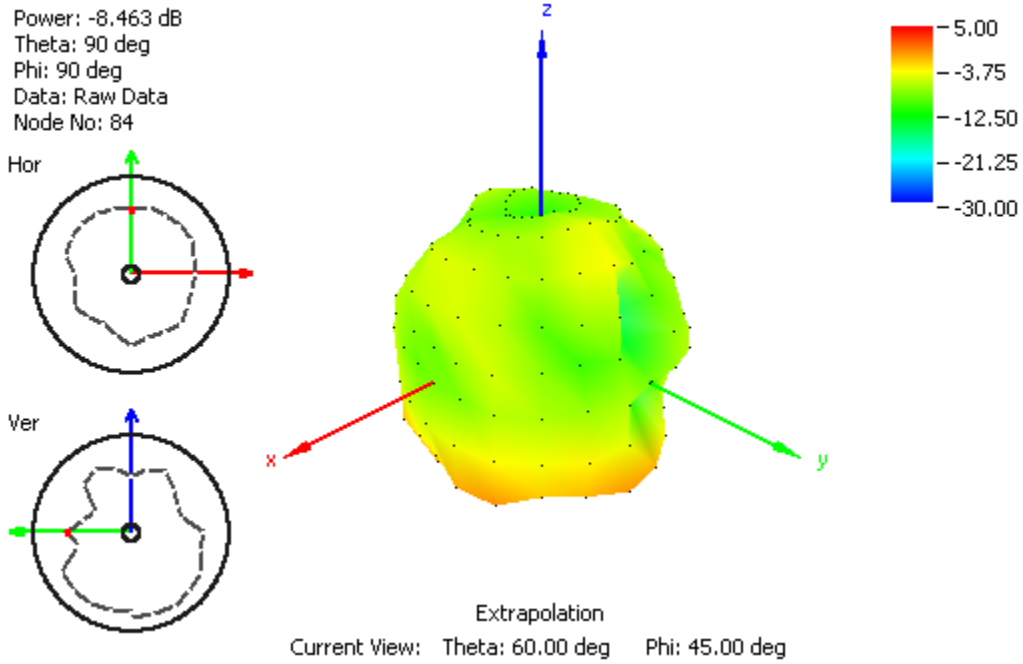

Figure 14. Radiation pattern at 900 MHz, Figure 1 as reference (dB), with 2m RG174 cable and 30x30 cm metal plate.

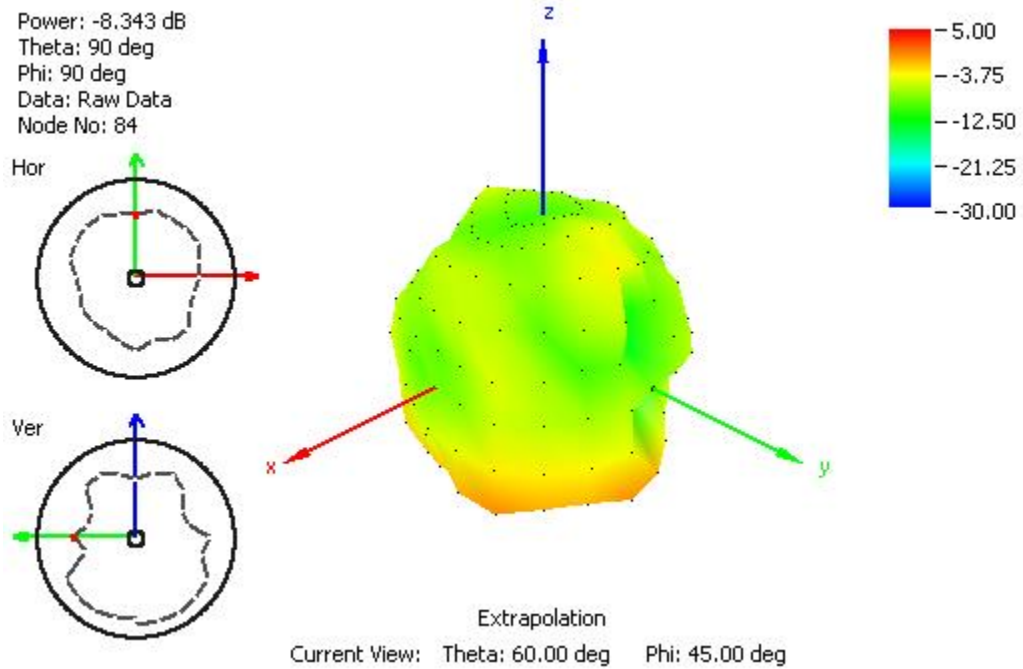

Figure 15. Radiation pattern at 915 MHz, Figure 1 as reference (dB), with 2m RG174 cable and 30x30 cm metal plate.

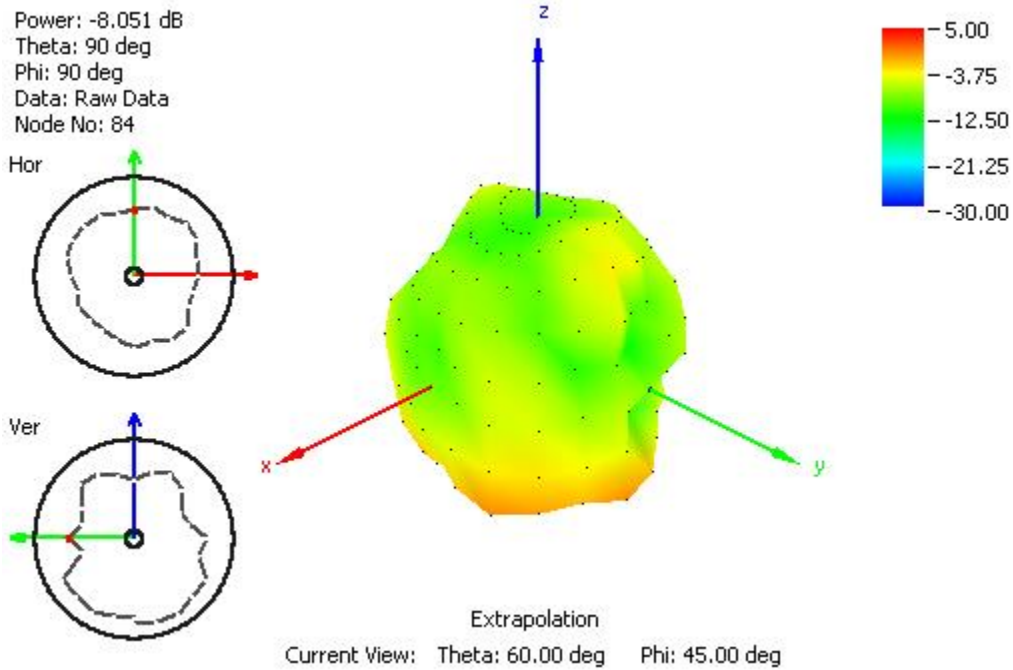

Figure 16. Radiation pattern at 930 MHz, Figure 1 as reference (dB), with 2m RG174 cable 30x30 cm metal plate.

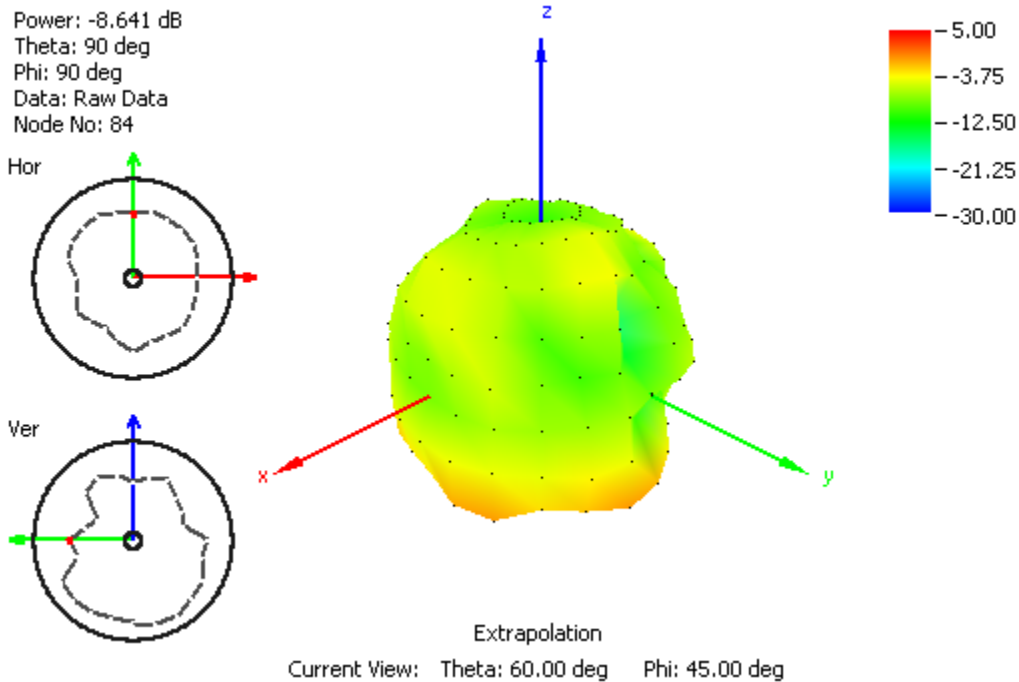

Figure 17. Radiation pattern at 900 MHz, Figure 1 as reference (dB), with 2m RG174 cable and 60x60 cm metal plate.

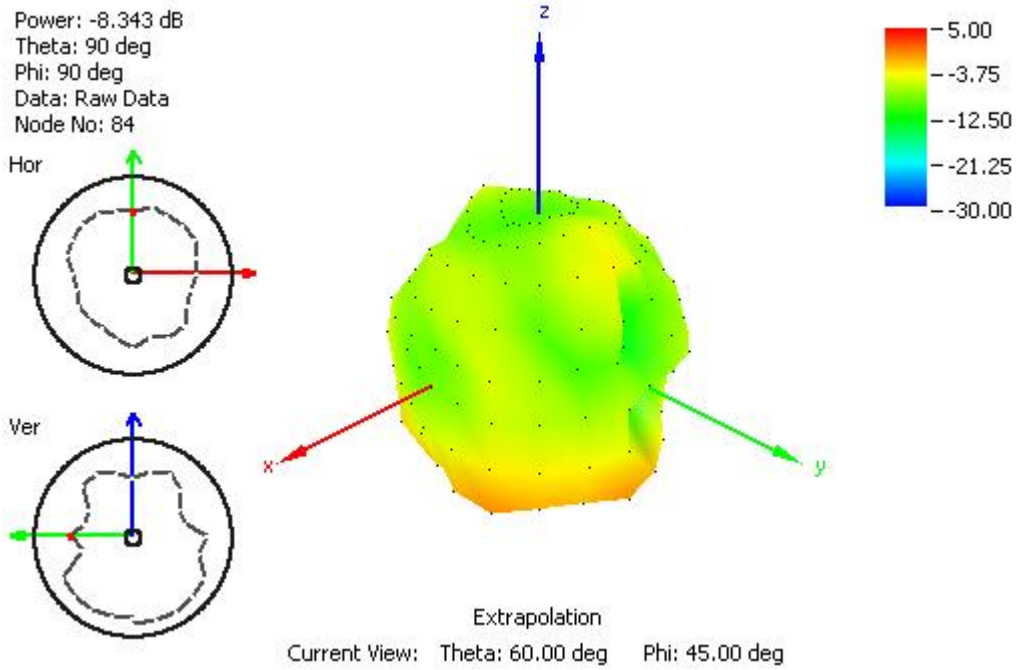

Figure 18. Radiation pattern at 915 MHz, Figure 1 as reference (dB), with 2m RG174 cable and 60x60 cm metal plate.

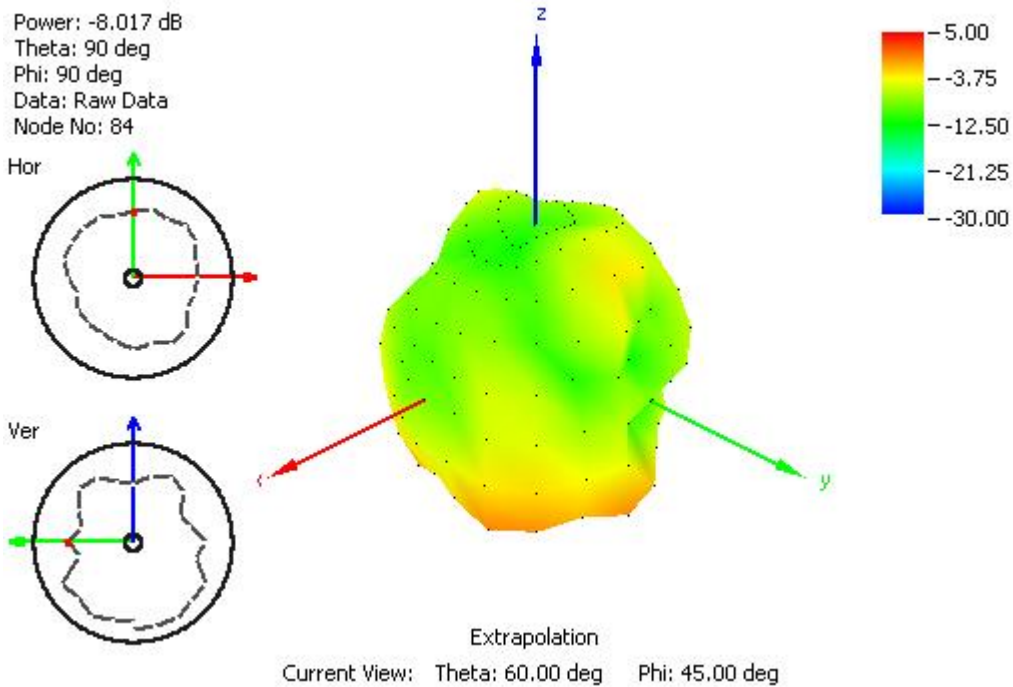
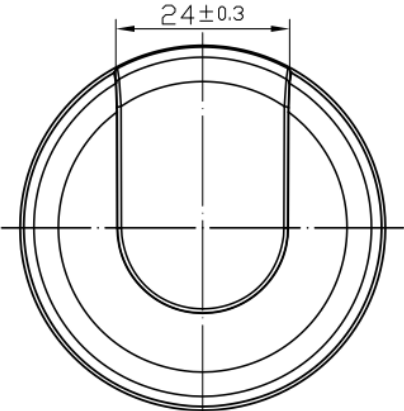

Figure 19. Radiation pattern at 930 MHz, Figure 1 as reference (dB), with 2m RG174 cable 60x60 cm metal plate.

5. DRAWING

Top View



Name	Material	Finish	QTY	
1	Housing	PC	Black	1
2	Closed Cell Foam	CR 4305	Black	1
3	3M Double Adhesive	3M 9448 WC	White Liner	1
4	M18 Inner Nut	Steel Carbon	Ni Plated	1
5	Outer Nut Cover	ABS	Black	1
6	Metal Base	Zinc Alloy	Ni Plated	1
7	Heat Shrink Tube	PE	Black	1
8	Rubber Stopper	Silicon Rubber	Black	1
9	915 MHz Label	Coated Paper	Olive Dra	1

Front View

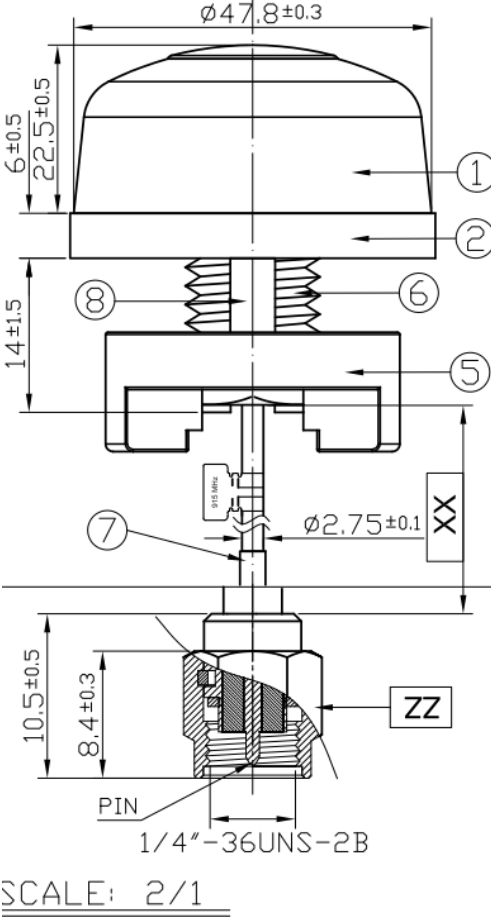

Side View

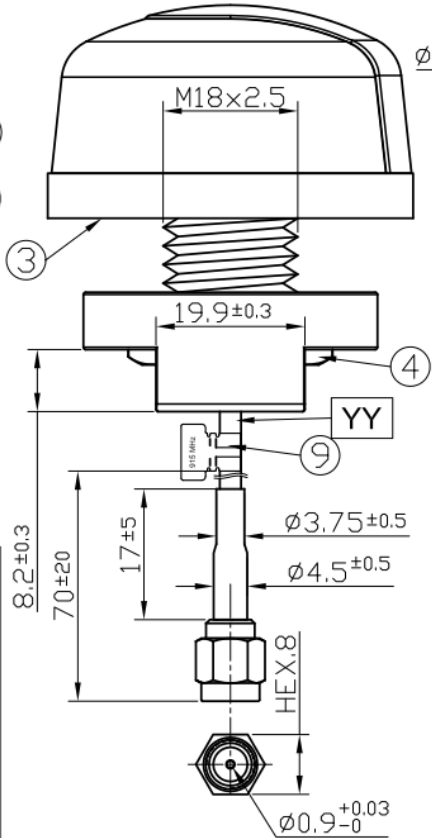

Bottom Thread View

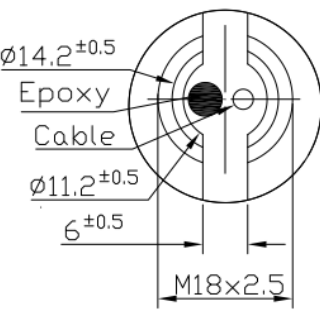

6. INSTALLATION

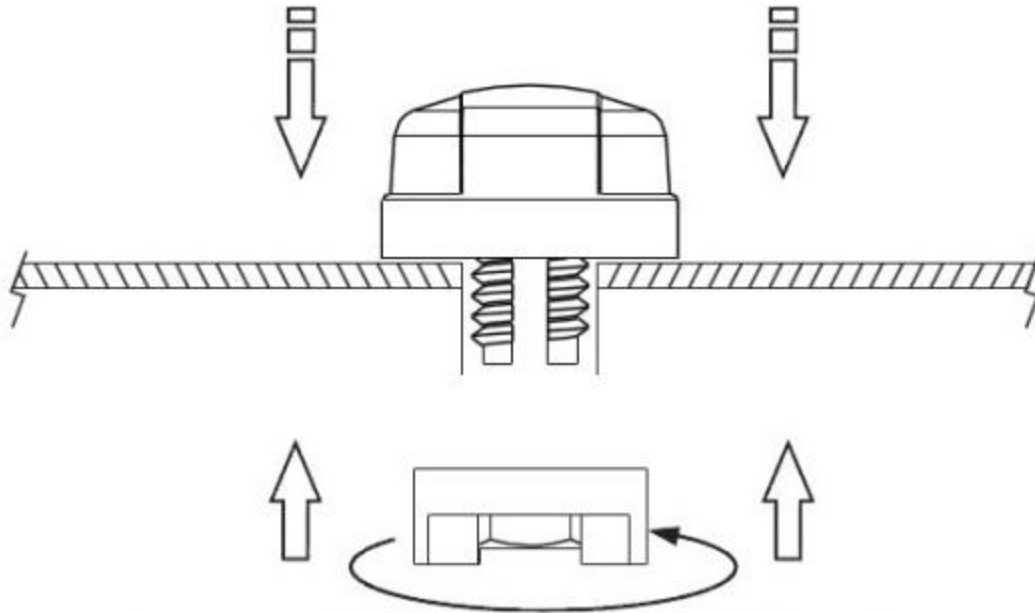

Recommended torque for Mounting is 24.5N·m
Maximum torque for mounting is 29.4N·m

7. PACKAGING

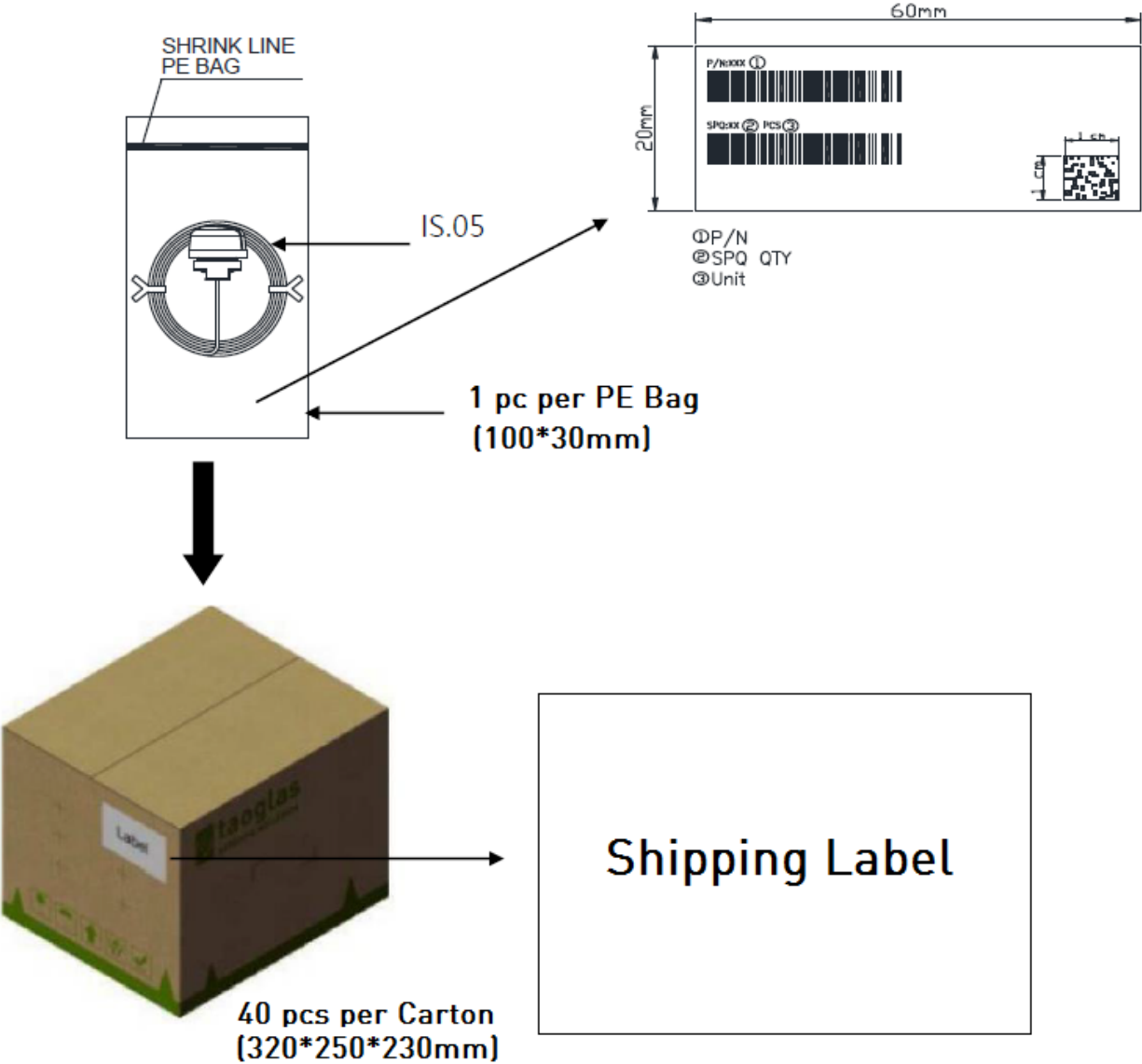

Taoglas makes no warranties based on the accuracy or completeness of the contents of this document and reserves the right to make changes to specifications and product descriptions at any time without notice. Taoglas reserves all rights to this document and the information contained herein.

Reproduction, use or disclosure to third parties without express permission is strictly prohibited.

© Taoglas