

General Specifications

Toggles

Rockers
B

Pushbuttons

Illuminated PB

Programmable

Keylocks

Rotaries

Slides

Tactiles

Tilt

Touch

Indicators

Accessories

Supplement

Electrical Capacity (Resistive Load)

Power Level: 9A @ 125V AC

Other Ratings

Contact Resistance: 20 milliohms maximum

Insulation Resistance: 500 megohms minimum @ 500V DC

Dielectric Strength: 1,500V AC minimum between contacts for 1 minute minimum;
3,000V AC minimum between contacts & case for 1 minute minimum

Mechanical Life: 30,000 operations minimum

Electrical Life: 10,000 operations minimum

Nominal Operating Force: 10.0N

Angle of Throw: 30°

Materials & Finishes

Rocker: Polycarbonate

Housing: Polyamide

Movable Contactor: Beryllium copper with silver plating

Movable Contacts: Silver alloy

Stationary Contacts: Silver alloy

Switch Terminals: Brass with silver plating

Lamp Terminals: Brass with silver plating

Environmental Data

Operating Temp Range: -20°C through +85°C (-4°F through +185°F)

Humidity: 90 ~ 95% humidity for 96 hours @ 40°C (104°F)

Vibration: 10 ~ 55Hz with peak-to-peak amplitude of 0.75mm traversing the frequency range
& returning in 1 minute; 3 right angled directions for 2 hours

Shock: 50G (490m/s²) acceleration (tested in 6 right angled directions, with 5 shocks in each direction)

Standards & Certifications

UL: File No. E44145
9A @ 125V AC
Markings on case are standard.

CSA: File No. 0701166_0_000
9A @ 125V AC
Markings on case are standard.

Distinctive Characteristics

Full face, Neon illumination in choice of red, amber, or green.

Neon lamp suited to 125V AC applications.

9-amp electrical capacity in compact body.

Built-in resistor for direct connection to 125V AC power source.

Low cost molded rocker.

Front panel, snap-in mounting assures labor-saving installation.

Single-break, snap-acting contact mechanism gives smooth actuation and audible feedback.

Quick-make, quick-break characteristic limits arcing and prolongs electrical life.

Stable stationary contact construction for high reliability.

Offset terminal alignment gives outstanding insulation resistance and dielectric strength.

Quick connect terminals (.187"/4.75mm) can be used with connectors.



Actual Size

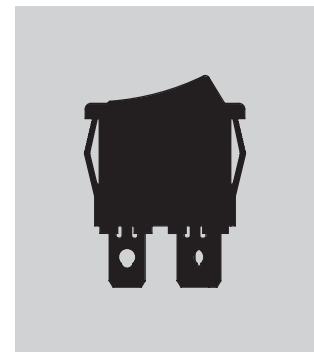

- Supplement
- Accessories
- Indicators
- Touch
- Tilt
- Tactiles
- Slides
- Rotaries
- Keylocks
- Programmable Illuminated PB
- Pushbuttons
- B** Rockers
- Toggles

TYPICAL SWITCH ORDERING EXAMPLE

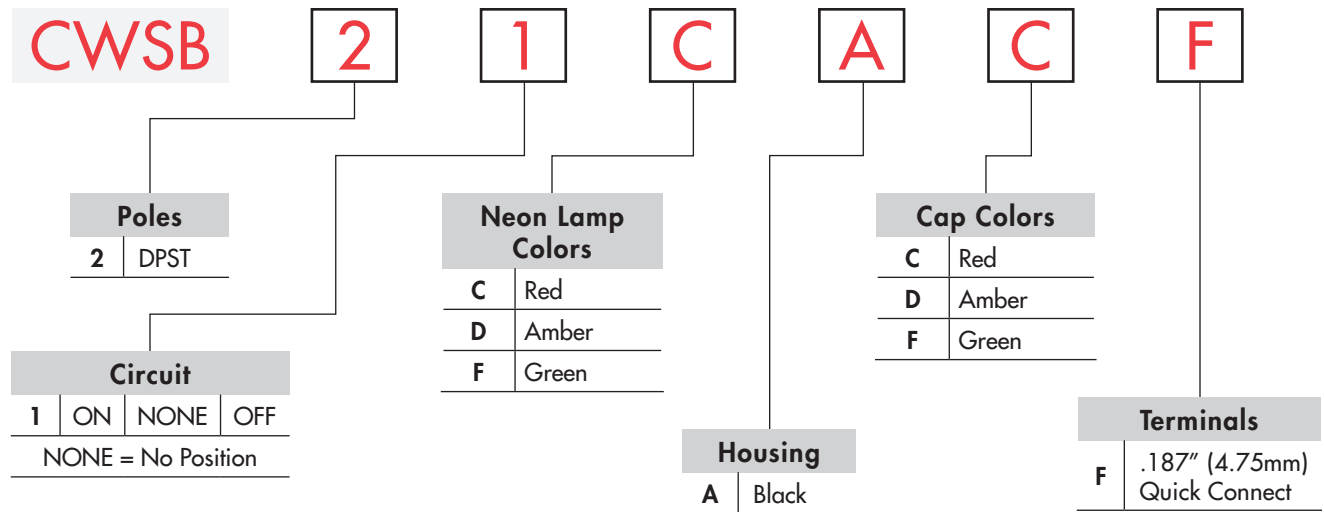

IMPORTANT:



Switches are supplied with UL & CSA markings on the case. Specific models & ratings noted on the General Specifications page.

DESCRIPTION FOR TYPICAL ORDERING EXAMPLE

CWSB21CAF

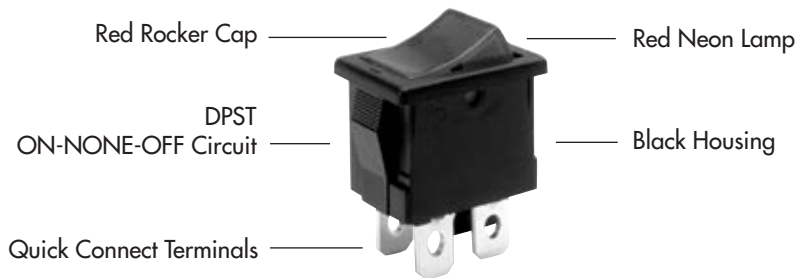

POLE & CIRCUIT

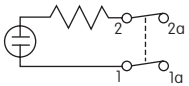
Pole	Model	Rocker Position NONE = No Position			Connected Terminals			Throw & Switch/Lamp Schematic
		Down	Center	Up	Down	Center	Up	
DP	CWSB21	ON	NONE	OFF	1-1a 2-2a	OPEN	OPEN	DPST 

Note: Terminal numbers "1a" and "2a" are actually on the switch.

NEON LAMP COLORS & SPECIFICATIONS

The Neon lamp is factory assembled and not available separately. The lamp circuit is synchronous to switching circuit.

The electrical specifications shown are determined at a basic temperature of 25°C.

Values for the built-in resistors are given in the accompanying table.

		Colors		
		C Red	D Amber	F Green
Voltage	V	125V AC	125V AC	125V AC
Internal Series Resistance		33K ohms	33K ohms	68K ohms
Current	I	1.4mA	1.4mA	0.6mA
Endurance	Hours	15,000	15,000	8,000

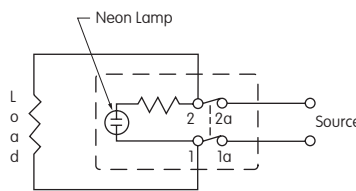

HOUSING

A Black Housing with Snap-in Mounting

On Off (I O) symbols are molded on the bezel.



TERMINALS

F .187" (4.75mm) Quick Connect

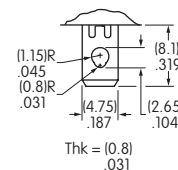

CAP COLOR CODES

Cap Colors Available

C Red **D** Amber **F** Green



Caps are factory assembled and are not available separately.

TYPICAL SWITCH DIMENSIONS

Double Pole

Neon Illuminated

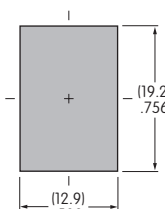
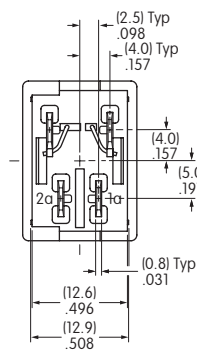
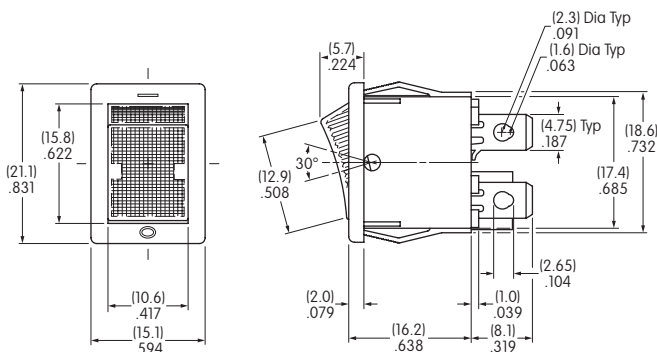

Panel Thickness
.030" ~ .079"
(0.75mm ~ 2.0mm)



CWSB21CACF