

TEST INSTRUCTIONS LABEL

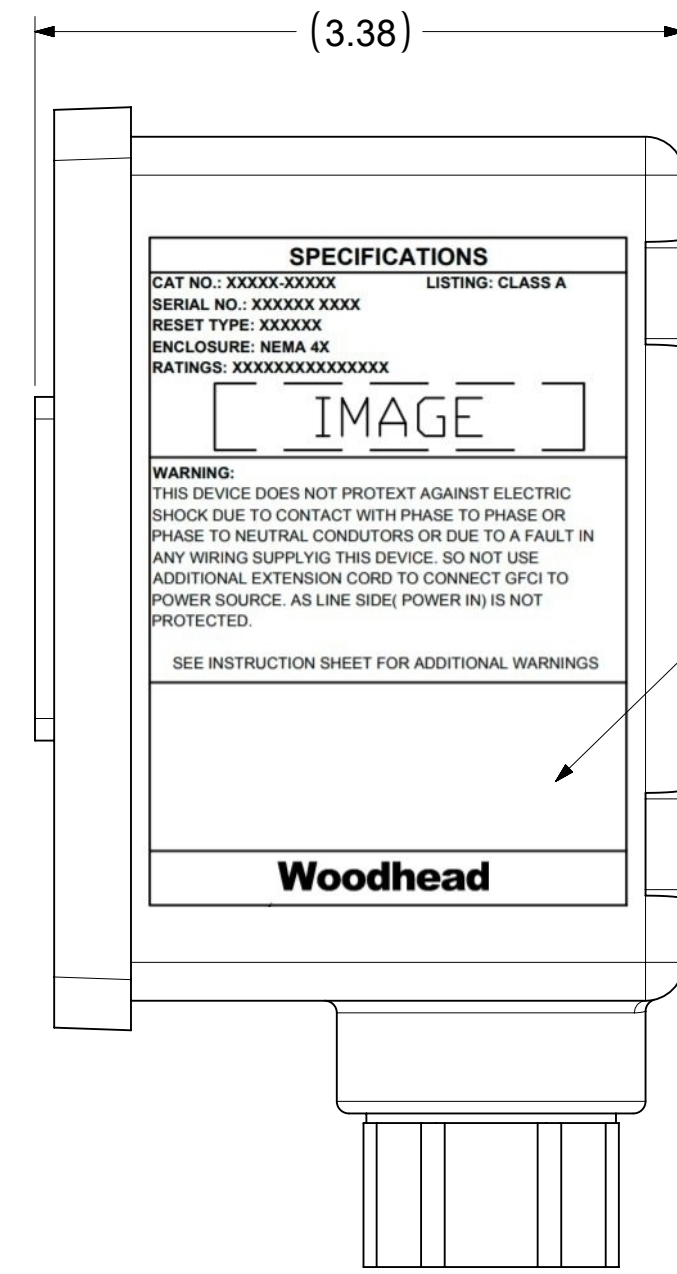

SPECIFICATIONS LABEL

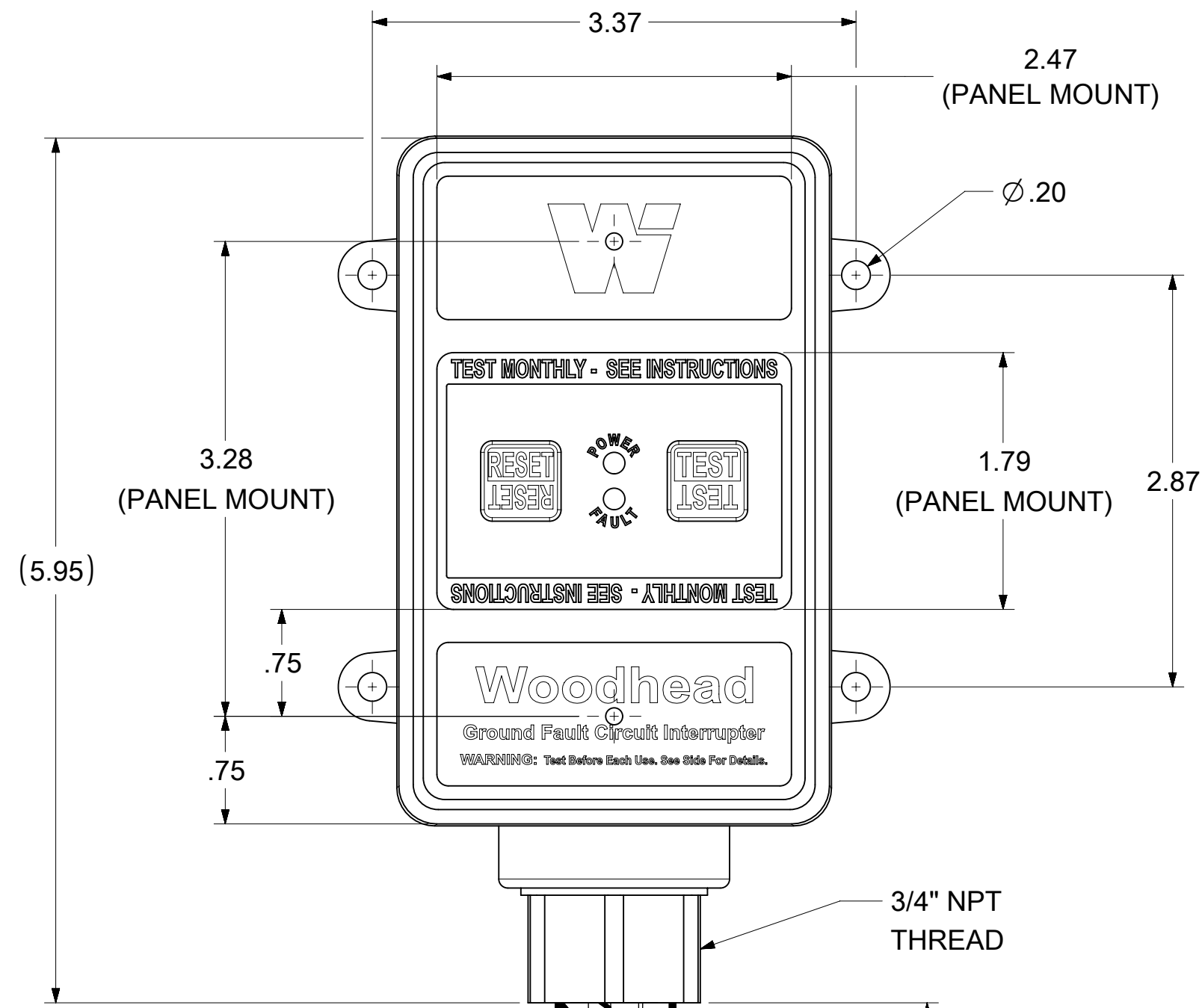
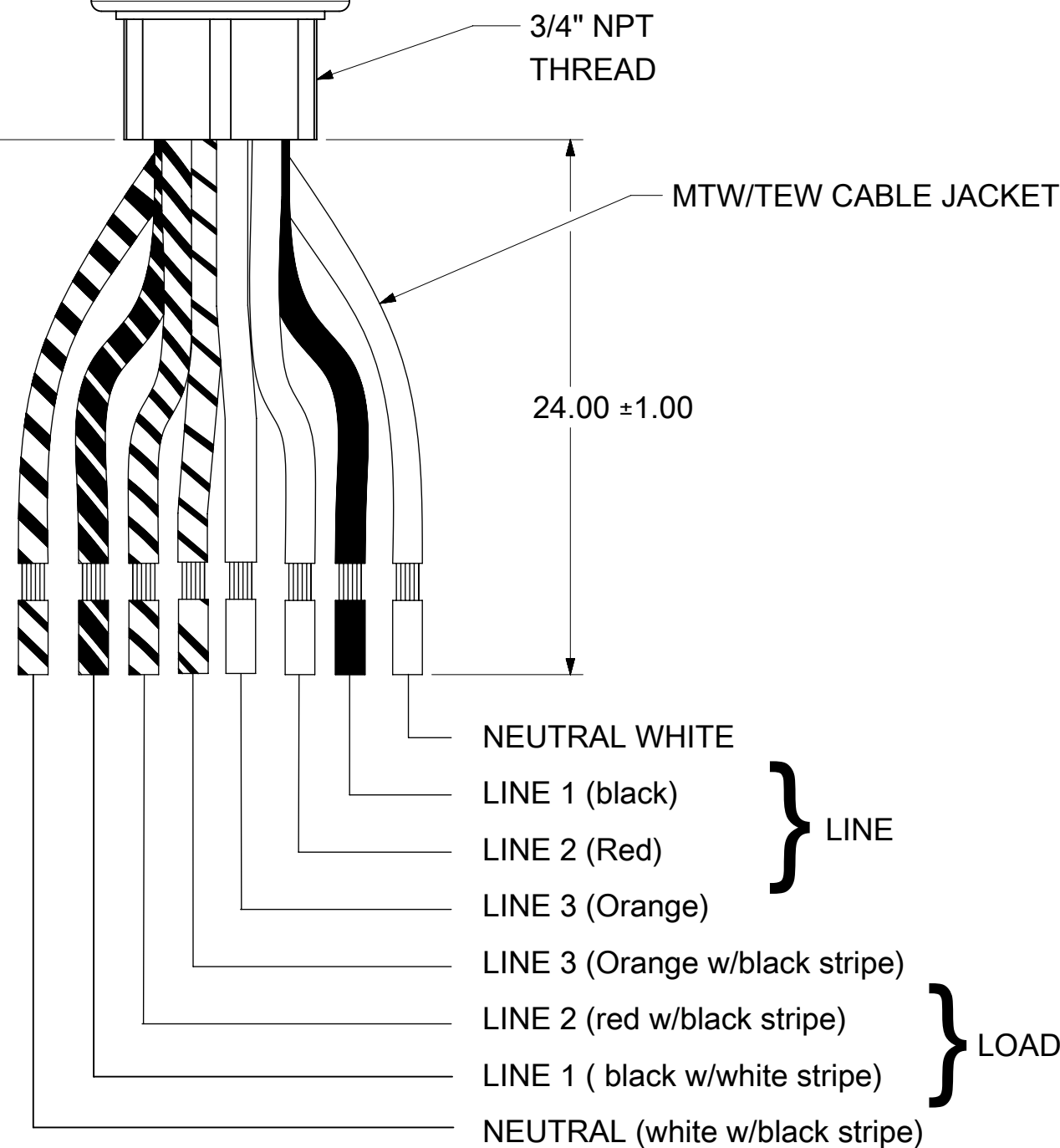

THREE PHASE "Y" (WITH NEUTRAL) (120 / 208 VOLTS)

TECHNICAL

LISTED:	UL & CSA
RATED SUPPLY VOLTAGE:	120/208VAC 3Ø
RATED CURRENT:	UP TO 30 AMPS
RESET TYPE:	AUTOMATIC OR MANUAL
OPERATING FREQUENCY:	60 Hz
TYPE:	CLASS A
GROUND TRIP CURRENT:	5mA +/- 1mA
OVERLOAD CURRENT:	180 AMPS, 0.45PF
INSULATION VOLTAGE:	1,500 VRMS - 1 MINUTE
ENDURANCE OPERATIONS:	3000 OPERATIONS
ENCLOSURE:	NEMA 4X/6P

RESET TYPE	MATERIAL NO.	ENGINEERING NO.	PHASE
MANUAL	1301530242	30053-2M5F	THREE PHASE W/ NEUTRAL
AUTOMATIC	1301530246	30053-2A5F	THREE PHASE W/ NEUTRAL

FUNCTIONAL SYMBOLS FA = 0 FC = 0 FP = 0	THIS DRAWING CONTAINS INFORMATION THAT IS PROPRIETARY TO MOLEX ELECTRONIC TECHNOLOGIES, LLC AND SHOULD NOT BE USED WITHOUT WRITTEN PERMISSION		CURRENT REV DESC: MIGRATION TO ECT/NX	
	DIMENSION UNITS	SCALE	EC NO: 670715	
	INCH	NTS	DRWN: PPURSUTANDEL	2021/07/29
	GENERAL TOLERANCES (UNLESS SPECIFIED)		CHK'D: DNGUYEN62	2021/07/29
DIVISIONAL SYMBOLS	4 PLACES	±	APPR: HKNEELAND	2021/07/30
	3 PLACES	±	INITIAL REVISION:	
	2 PLACES	±	DRWN: PPURSUTANDEL	2021/07/29
	1 PLACE	±	APPR: HKNEELAND	2021/07/30
0 PLACES		±	THIRD ANGLE PROJECTION	
ANGULAR TOL		± °	DRAWING	SERIES
DRAFT WHERE APPLICABLE MUST REMAIN WITHIN DIMENSIONS			C-SIZE	130153



30A, 120/208VAC 3PHASE, 24" 10 GA

PRODUCT CUSTOMER DRAWING

DOCUMENT NUMBER: 1301530242

DOC TYPE: PSD, DOC PART: 000, REVISION: B2

MATERIAL NUMBER: SEE TABLE, CUSTOMER: GENERAL MARKET, SHEET NUMBER: 1 OF 1

OLD DOCUMENT NO. SD-130153-039

TECHNICAL:
RATED VOLTAGE: 120VAC, 208VAC, 240VAC, 277VAC, 120/240VAC, 120/208VAC Dual Voltage, 120/208VAC 3Ø, 208VAC 3Ø, 240VAC 3Ø (277VAC non-U.L.)
OPERATING VOLTAGE RANGE: 85% TO 110% OF RATED
CURRENT: UP TO 30 AMPS OR WIRING DEVICE RATING
FREQUENCY: 60Hz, 50Hz (AVAILABLE non-UL)
TRIP LEVEL: 5 ± 1mA
PHASE: SINGLE, DUAL VOLTAGE, AND THREE-PHASE
RESPONSE TIME: 25 mS MAX. @500 OHM FAULT
DIELECTRIC WITHSTAND: 1500 VRMS ACROSS CONTACT
 4000 VRMS BETWEEN CONDUCTORS AND ENCLOSURE
 6000V IMPULSE, 0.5 MICROSECOND RISE TIME 100KHZ RINGING FREQUENCY WITH 40% DECAY PER CYCLE
OPERATING TEMPERATURE RANGE: -35°C TO +66°C (-31°F TO +151°F)
LEAKAGE CURRENT @ 93% HUMIDITY: ZERO
OVERLOAD CURRENT: 180 AMPS, 50% INDUCTIVE (25 CYCLES)
RF NOISE SUSCEPTIBILITY: NORMAL OPERATION WITH 0.5 VRMS INJECTED ON POWER LINE WITH FREQUENCIES UP TO 450 MHz
CURRENT FILTERS: SPECIFICALLY FILTERED TO MINIMIZE NUISANCE TRIPS IN WELDING, VARIABLE FREQUENCY DRIVE AND OTHER 'ELECTRICALLY NOISY' APPLICATIONS
LET GO LINE VOLTAGE: 60% OF RATED
GROUNDING DETECTION: 2 OHMS OR LESS (ON APPLICABLE MODELS ONLY)

GENERAL:
CONSTRUCTION: INDUSTRIAL GRADE DESIGN
TYPE: CLASS A
POWER-UP TYPE: AUTO OR MANUAL
ENDURANCE: 5000 OPERATIONS MINIMUM AT RATED LOAD
OPEN NEUTRAL PROTECTION: TRIPS UPON LOSS OF NEUTRAL (ON APPLICABLE MODELS ONLY)
GROUNDING NEUTRAL PROTECTION: TRIPS IF GROUND AND NEUTRAL TOUCH AT LOAD SIDE (ON APPLICABLE MODELS ONLY)
POWER ON INDICATION: LIGHTED GREEN LED
POWER OFF INDICATION: BLINKING RED LED, PLUS OPTIONAL ANNUNCIATOR OF AC/DC OUTPUTS (ON APPLICABLE MODELS ONLY)
ENCLOSURE: NEMA 4X/P6
MOUNTING TYPE: PANEL, SURFACE AND PORTABLE
WIRING APPLICATION: 3,4,5 WIRE SINGLE, SPLIT, AND 3-PHASE
WIRING CONNECTIONS: PORTABLE (IN-LINE) AND PERMANENT (FIXED MOUNT) (SEE WIRING INSTRUCTIONS)
SWITCH INTERFACE: DOUBLE INSULATED
LATCHING MECHANISM: ELECTROMAGNETIC
FALSE TRIP DUE TO IMPACT: NONE
AGENCY APPROVAL: cULus, CSA, CSAus and cCSAus (U.L.943 and CSA C22.2 No. 144) (277VAC non-U.L.)

INDUSTRIAL GRADE DESIGN
 CLASS A
 AUTO OR MANUAL
 5000 OPERATIONS MINIMUM AT RATED LOAD
 TRIPS UPON LOSS OF NEUTRAL (ON APPLICABLE MODELS ONLY)
 TRIPS IF GROUND AND NEUTRAL TOUCH AT LOAD SIDE (ON APPLICABLE MODELS ONLY)
 LIGHTED GREEN LED
 BLINKING RED LED, PLUS OPTIONAL ANNUNCIATOR OF AC/DC OUTPUTS (ON APPLICABLE MODELS ONLY)
 NEMA 4X/P6
 PANEL, SURFACE AND PORTABLE
 3,4,5 WIRE SINGLE, SPLIT, AND 3-PHASE
 PORTABLE (IN-LINE) AND PERMANENT (FIXED MOUNT) (SEE WIRING INSTRUCTIONS)
 DOUBLE INSULATED
 ELECTROMAGNETIC
 NONE
 cULus, CSA, CSAus and cCSAus (U.L.943 and CSA C22.2 No. 144) (277VAC non-U.L.)

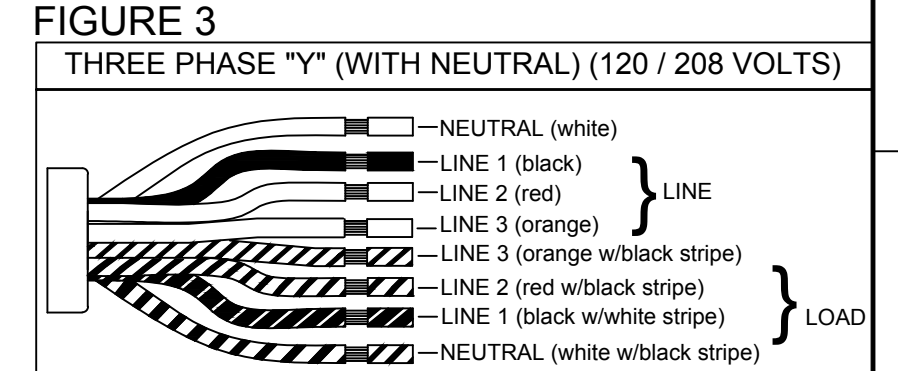
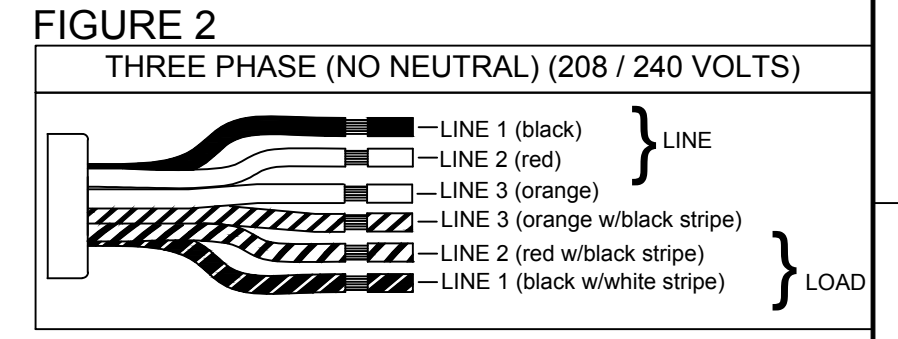
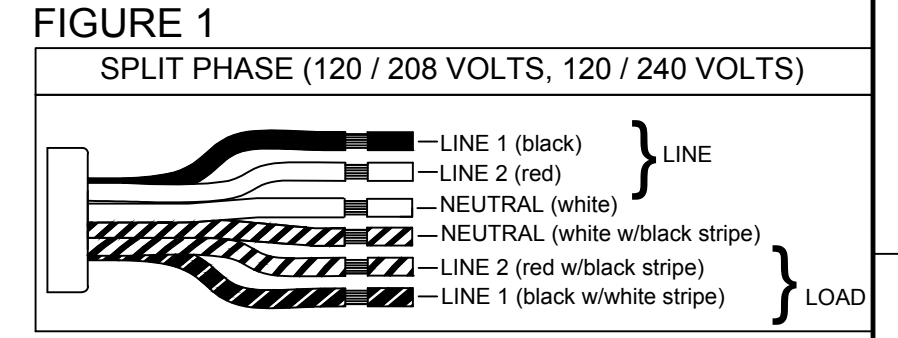
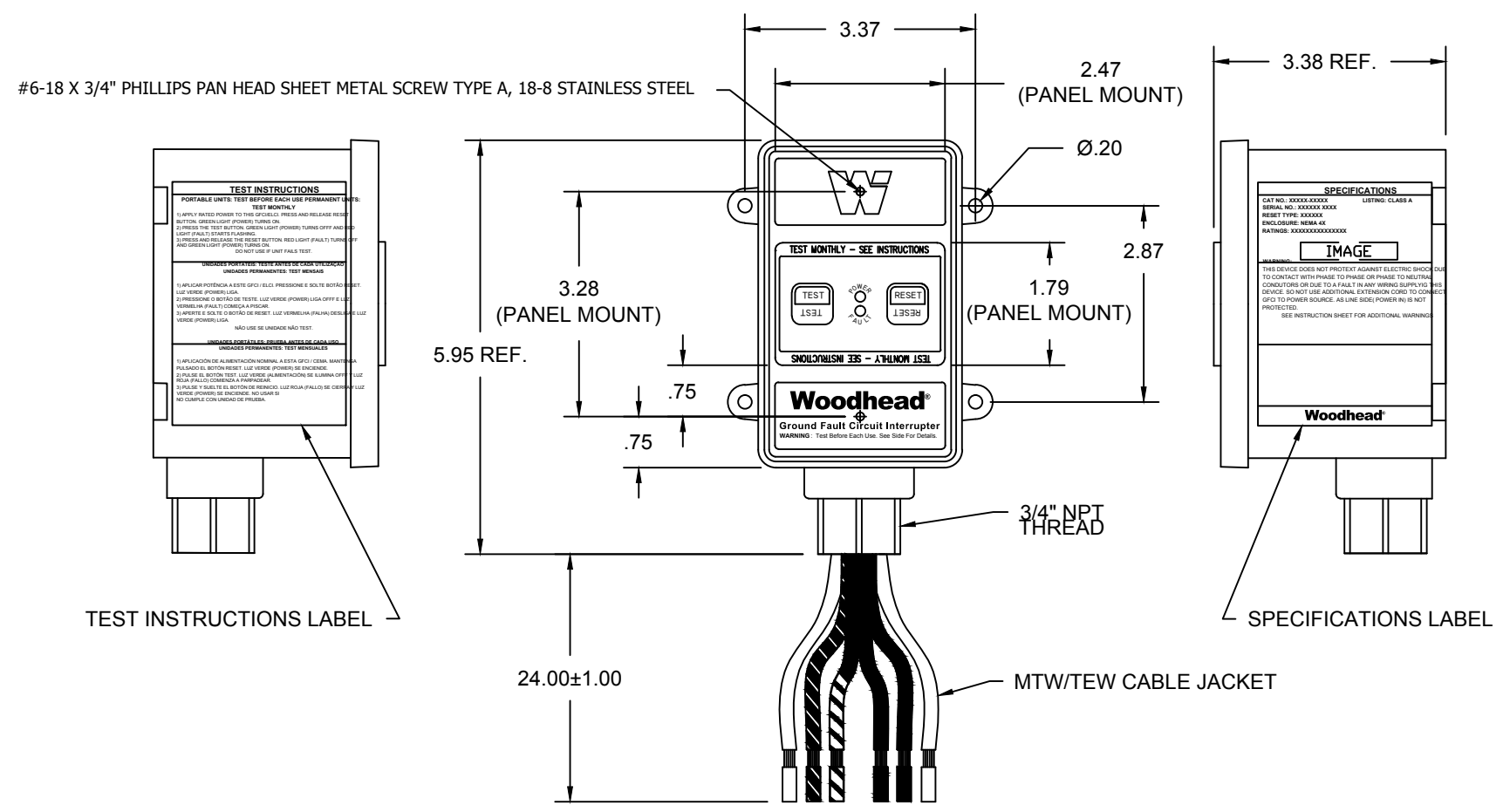

RESET TYPE	MATERIAL NO.	ENGINEERING NO.	PHASE	FIGURE
MANUAL	1301530239	30053-2M6F	SPLIT PHASE	FIGURE 1
	1301530240	30053-2M3F	THREE PHASE	FIGURE 2
	1301530241	30053-2M2F	THREE PHASE	FIGURE 2
AUTOMATIC	1301530242	30053-2M5F	THREE PHASE W/ NEUTRAL	FIGURE 3
	1301530243	30053-2A6F	SPLIT PHASE	FIGURE 1
	1301530244	30053-2A3F	THREE PHASE	FIGURE 2
	1301530245	30053-2A2F	THREE PHASE	FIGURE 2
	1301530246	30053-2A5F	THREE PHASE W/ NEUTRAL	FIGURE 3

UPDATED SPECS EC NO: IPG2014-1788 DRWN: BARDEN 2014/04/14 CHKD: HKNEELAN 2014/04/30 APPR: JFMURPHY 2014/03/27	QUALITY SYMBOLS ▽=0 ◁=0	GENERAL TOLERANCES (UNLESS SPECIFIED)		DIMENSION STYLE IN/MM		SCALE NTS DESIGN UNITS INCH	THIRD ANGLE PROJECTION
		4 PLACES ±--- ±--- 3 PLACES ±--- ±.005 2 PLACES ±0.13 ±.010 1 PLACE ±0.25 ±.020	ANGULAR ±1/2°		DRAWN BY BARDEN DATE 2014/01/08		
REV B	DRAFT WHERE APPLICABLE MUST REMAIN WITHIN DIMENSIONS	SEE CHART		APPROVED BY JFMURPHY DATE 2014/03/27		MOLEX INCORPORATED	
		MATERIAL NO.		DOCUMENT NO. SD-130153-039		SHEET NO. 1 OF 1	
THIS DRAWING CONTAINS INFORMATION THAT IS PROPRIETARY TO MOLEX INCORPORATED AND SHOULD NOT BE USED WITHOUT WRITTEN PERMISSION							