

16A, 20V - 100V Schottky Barrier Surface Mount Rectifier

FEATURES

- Low power loss, high efficiency
- Ideal for automated placement
- Guard ring for overvoltage protection
- High surge current capability
- Moisture sensitivity level: level 1, per J-STD-020
- RoHS Compliant
- Halogen-free according to IEC 61249-2-21

APPLICATIONS

- Switching mode power supply (SMPS)
- Adapters
- DC to DC converters

MECHANICAL DATA

- Case: TO-263AB (D²PAK)
- Molding compound meets UL 94V-0 flammability rating
- Terminal: Matte tin plated leads, solderable per J-STD-002
- Meet JESD 201 class 2 whisker test
- Polarity: As marked
- Weight: 1.37g (approximately)

KEY PARAMETERS		
PARAMETER	VALUE	UNIT
I_F	16	A
V_{RRM}	20 - 100	V
I_{FSM}	150	A
T_{JMAX}	125, 150	°C
Package	TO-263AB (D ² PAK)	
Configuration	Dual dies	

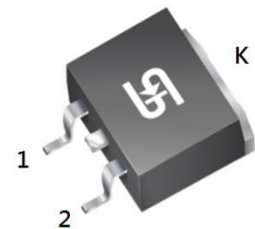

TO-263AB (D²PAK)

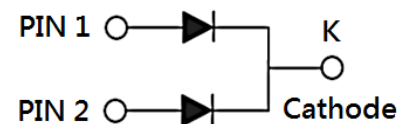

ABSOLUTE MAXIMUM RATINGS ($T_A = 25^\circ\text{C}$ unless otherwise noted)										
PARAMETER	SYMBOL	SRS 1620	SRS 1630	SRS 1640	SRS 1650	SRS 1660	SRS 1690	SRS 16100	UNIT	
Marking code on the device		SRS 1620	SRS 1630	SRS 1640	SRS 1650	SRS 1660	SRS 1690	SRS 16100		
Repetitive peak reverse voltage	V_{RRM}	20	30	40	50	60	90	100	V	
Reverse voltage, total rms value	$V_{R(RMS)}$	14	21	28	35	42	63	70	V	
Forward current	I_F	16								A
Surge peak forward current, 8.3ms single half sine wave superimposed on rated load	I_{FSM}	150								A
Junction temperature	T_J	-55 to +125			-55 to +150					°C
Storage temperature	T_{STG}	-55 to +150								°C

THERMAL PERFORMANCE			
PARAMETER	SYMBOL	TYP	UNIT
Junction-to-case thermal resistance	$R_{\theta JC}$	2	°C/W

ELECTRICAL SPECIFICATIONS ($T_A = 25^\circ\text{C}$ unless otherwise noted)						
PARAMETER		CONDITIONS	SYMBOL	TYP	MAX	UNIT
Forward voltage per diode ⁽¹⁾	SRS1620 SRS1630 SRS1640	$I_F = 8\text{A}, T_J = 25^\circ\text{C}$	V_F	-	0.55	V
	SRS1650 SRS1660			-	0.70	V
	SRS1690 SRS16100			-	0.90	V
Reverse current @ rated V_R per diode ⁽²⁾	SRS1620 SRS1630 SRS1640 SRS1650 SRS1660	$T_J = 25^\circ\text{C}$	I_R	-	500	μA
	SRS1690 SRS16100	$T_J = 100^\circ\text{C}$		-	100	μA
	SRS1620 SRS1630 SRS1640			-	15	mA
	SRS1650 SRS1660			-	10	mA
	SRS1690 SRS16100	$T_J = 125^\circ\text{C}$		-	-	mA
	SRS1620 SRS1630 SRS1640 SRS1650 SRS1660			-	-	mA
	SRS1690 SRS16100			-	5	mA

Notes:

1. Pulse test with $PW = 0.3\text{ms}$
2. Pulse test with $PW = 30\text{ms}$

ORDERING INFORMATION		
ORDERING CODE⁽¹⁾	PACKAGE	PACKING
SRS16x	TO-263AB (D ² PAK)	800 / Tape & Reel

Notes:

1. "x" defines voltage from 20V(SRS1620) to 100V(SRS16100)

CHARACTERISTICS CURVES

($T_A = 25^\circ\text{C}$ unless otherwise noted)

Fig.1 Forward Current Derating Curve

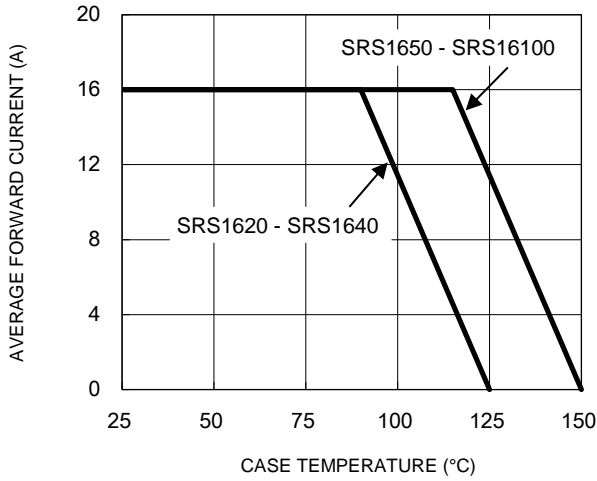

Fig.2 Typical Junction Capacitance

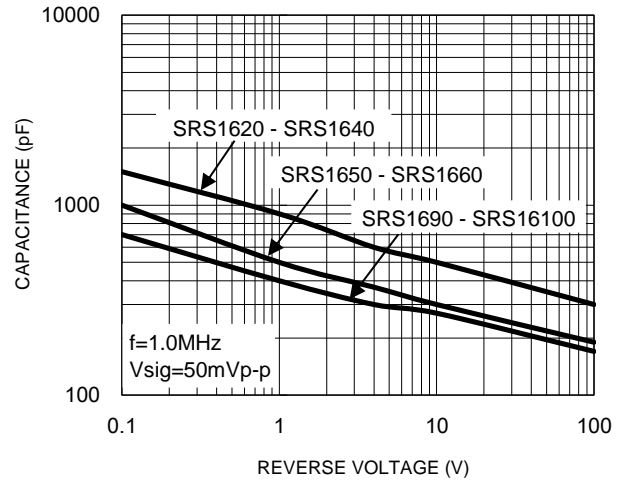

Fig.3 Typical Reverse Characteristics

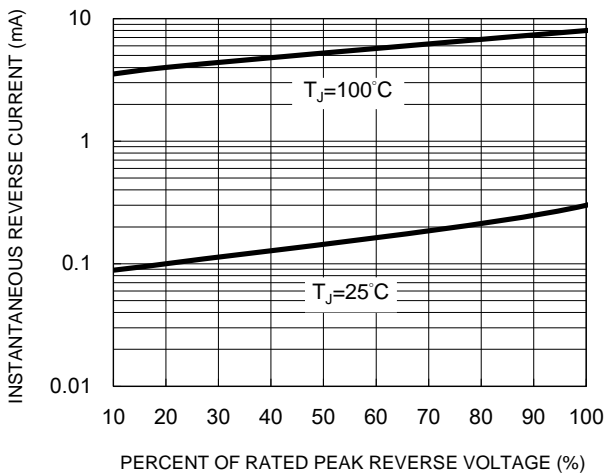

Fig.4 Typical Forward Characteristics

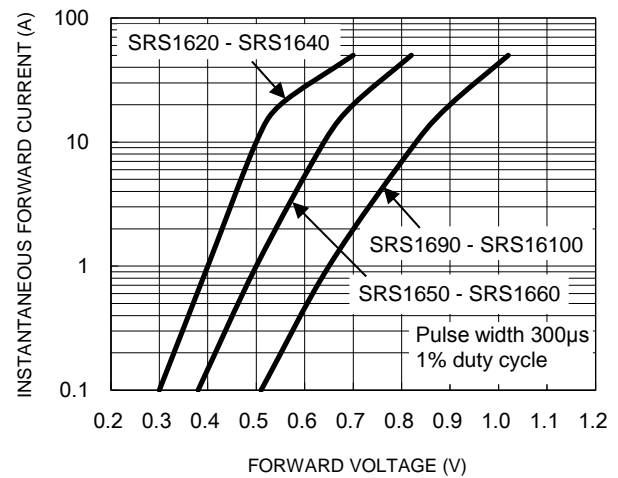
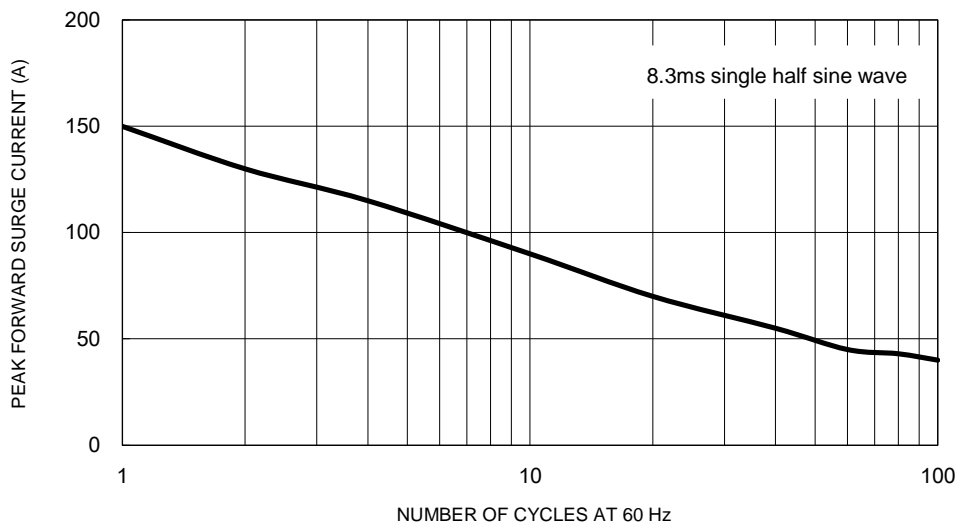

Fig.5 Maximum Non-Repetitive Forward Surge Current



CHARACTERISTICS CURVES

($T_A = 25^\circ\text{C}$ unless otherwise noted)

Fig.6 Typical Transient Thermal Impedance

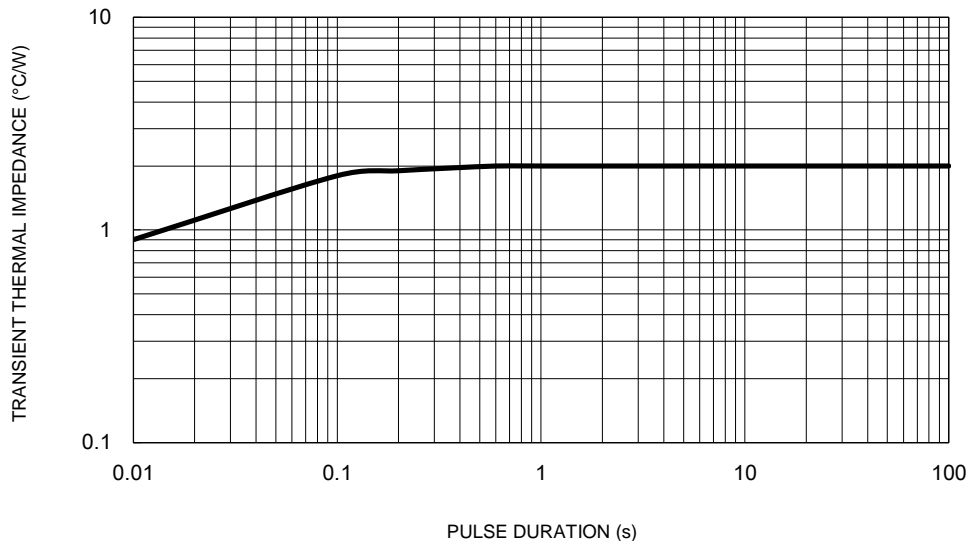

PACKAGE OUTLINE DIMENSIONS

TO-263AB (D²PAK)

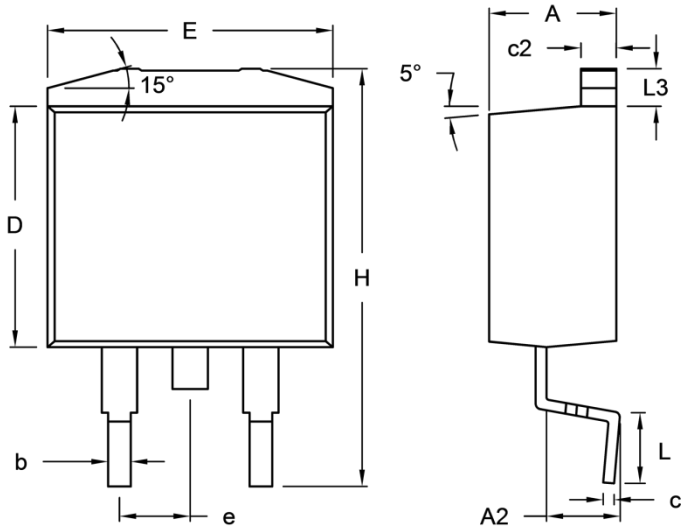

DIM.	Unit (mm)		Unit (inch)	
	Min.	Max.	Min.	Max.
A	4.44	4.70	0.175	0.185
A2	2.03	2.79	0.080	0.110
b	0.68	0.94	0.027	0.037
c	0.36	0.53	0.014	0.021
c2	1.14	1.40	0.045	0.055
D	8.25	9.25	0.325	0.364
E	-	10.50	-	0.413
e	2.41	2.67	0.095	0.105
H	14.60	15.88	0.575	0.625
L	2.29	2.79	0.090	0.110
L3	1.14	1.40	0.045	0.055

SUGGESTED PAD LAYOUT

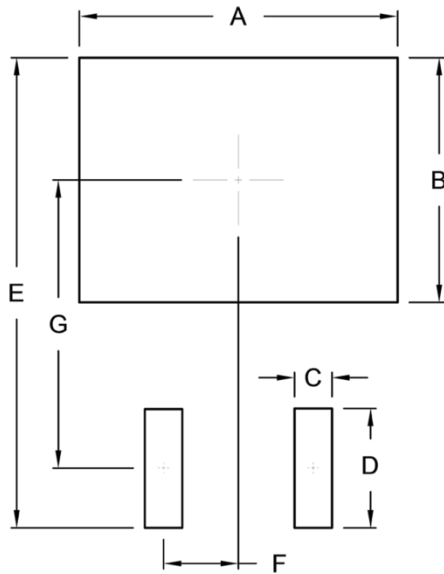

Symbol	Unit (mm)	Unit (inch)
A	10.80	0.425
B	8.30	0.327
C	1.27	0.050
D	4.05	0.159
E	15.95	0.628
F	2.54	0.100
G	9.775	0.385

MARKING DIAGRAM



- P/N = Marking Code
- G = Green Compound
- YWW = Date Code
- F = Factory Code

Notice

Specifications of the products displayed herein are subject to change without notice. TSC or anyone on its behalf assumes no responsibility or liability for any errors or inaccuracies.

Purchasers are solely responsible for the choice, selection, and use of TSC products and TSC assumes no liability for application assistance or the design of Purchasers' products.

Information contained herein is intended to provide a product description only. No license, express or implied, to any intellectual property rights is granted by this document. Except as provided in TSC's terms and conditions of sale for such products, TSC assumes no liability whatsoever, and disclaims any express or implied warranty, relating to sale and/or use of TSC products including liability or warranties relating to fitness for a particular purpose, merchantability, or infringement of any patent, copyright, or other intellectual property right.

The products shown herein are not designed for use in medical, life-saving, or life-sustaining applications. Customers using or selling these products for use in such applications do so at their own risk and agree to fully indemnify TSC for any damages resulting from such improper use or sale.