

## N-Channel Enhancement Mode Power MOSFET

### Description

The G58N06F uses advanced trench technology to provide excellent  $R_{DS(ON)}$ , low gate charge. It can be used in a wide variety of applications.

### General Features

- $V_{DS}$  60V
- $I_D$  (at  $V_{GS} = 10V$ ) 35A
- $R_{DS(ON)}$  (at  $V_{GS} = 10V$ ) < 13m $\Omega$
- $R_{DS(ON)}$  (at  $V_{GS} = 4.5V$ ) < 15m $\Omega$
- 100% Avalanche Tested
- RoHS Compliant

### Application

- Power switch
- DC/DC converters

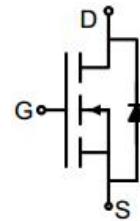

Schematic diagram

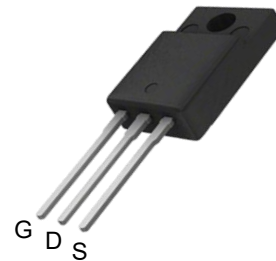

TO-220F

### Ordering Information

Device	Package	Marking	Packaging
G58N06F	TO-220F	G58N06	50pcs/Tube

### Absolute Maximum Ratings $T_C = 25^\circ\text{C}$ , unless otherwise noted

Parameter	Symbol	Value	Unit
Drain-Source Voltage	$V_{DS}$	60	V
Continuous Drain Current	$I_D$	35	A
Pulsed Drain Current (note1)	$I_{DM}$	140	A
Gate-Source Voltage	$V_{GS}$	$\pm 20$	V
Power Dissipation	$P_D$	44	W
Single pulse avalanche energy (note2)	$E_{AS}$	100	mJ
Operating Junction and Storage Temperature Range	$T_J, T_{stg}$	-55 To 150	$^\circ\text{C}$

### Thermal Resistance

Parameter	Symbol	Value	Unit
Thermal Resistance, Junction-to-Ambient	$R_{thJA}$	60	$^\circ\text{C/W}$
Maximum Junction-to-Case	$R_{thJC}$	2.8	$^\circ\text{C/W}$

Specifications $T_J = 25^\circ\text{C}$ , unless otherwise noted						
Parameter	Symbol	Test Conditions	Value			Unit
			Min.	Typ.	Max.	
<b>Static Parameters</b>						
Drain-Source Breakdown Voltage	$V_{(BR)DSS}$	$V_{GS} = 0V, I_D = 250\mu A$	60	--	--	V
Zero Gate Voltage Drain Current	$I_{DSS}$	$V_{DS} = 60V, V_{GS} = 0V$	--	--	1	$\mu A$
Gate-Source Leakage	$I_{GSS}$	$V_{GS} = \pm 20V$	--	--	$\pm 100$	nA
Gate-Source Threshold Voltage	$V_{GS(th)}$	$V_{DS} = V_{GS}, I_D = 250\mu A$	1	1.9	2.4	V
Drain-Source On-Resistance	$R_{DS(on)}$	$V_{GS} = 10V, I_D = 30A$	--	10	13	m $\Omega$
		$V_{GS} = 4.5V, I_D = 25A$	--	12	15	
Forward Transconductance	$g_{FS}$	$V_{GS} = 5V, I_D = 30A$	--	83	--	S
<b>Dynamic Parameters</b>						
Input Capacitance	$C_{iss}$	$V_{GS} = 0V,$ $V_{DS} = 30V,$ $f = 1.0MHz$	--	3006	--	pF
Output Capacitance	$C_{oss}$		--	161	--	
Reverse Transfer Capacitance	$C_{rss}$		--	143	--	
Total Gate Charge	$Q_g$	$V_{DD} = 30V,$ $I_D = 30A,$ $V_{GS} = 10V$	--	75	--	nC
Gate-Source Charge	$Q_{gs}$		--	13.5	--	
Gate-Drain Charge	$Q_{gd}$		--	19.5	--	
Turn-on Delay Time	$t_{d(on)}$	$V_{DD} = 30V,$ $I_D = 30A,$ $R_G = 3\Omega$	--	60	--	ns
Turn-on Rise Time	$t_r$		--	21	--	
Turn-off Delay Time	$t_{d(off)}$		--	69	--	
Turn-off Fall Time	$t_f$		--	48	--	
<b>Drain-Source Body Diode Characteristics</b>						
Continuous Body Diode Current	$I_S$	$T_C = 25^\circ\text{C}$	--	--	35	A
Body Diode Voltage	$V_{SD}$	$T_J = 25^\circ\text{C}, I_{SD} = 30A, V_{GS} = 0V$	--	--	1.2	V
Reverse Recovery Charge	$Q_{rr}$	$I_F = 30A, V_{GS} = 0V$ $di/dt = 100A/us$	--	147	--	nC
Reverse Recovery Time	$T_{rr}$		--	87	--	ns

### Notes

1. Repetitive Rating: Pulse width limited by maximum junction temperature
2. EAS condition :  $T_J = 25^\circ\text{C}, V_{DD} = 50V, V_{GS} = 10V, L = 0.5mH, R_G = 25\Omega$
3. Identical low side and high side switch with identical  $R_G$

### Gate Charge Test Circuit



### Switch Time Test Circuit



### EAS Test Circuit

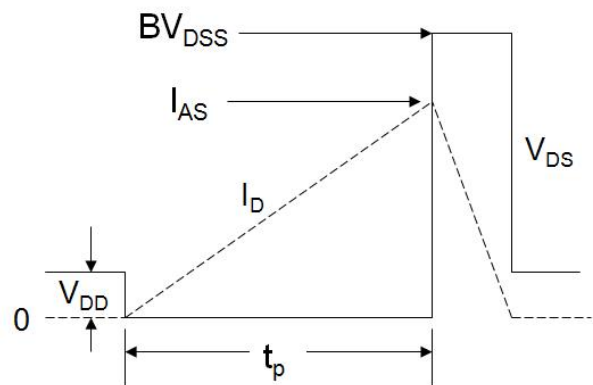

Typical Characteristics  $T_J = 25^\circ\text{C}$ , unless otherwise noted

**Figure 1. Output Characteristics**

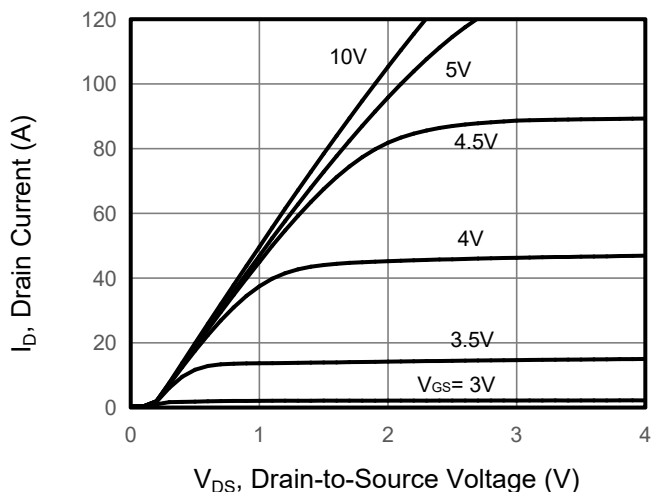

**Figure 2. Transfer Characteristics**

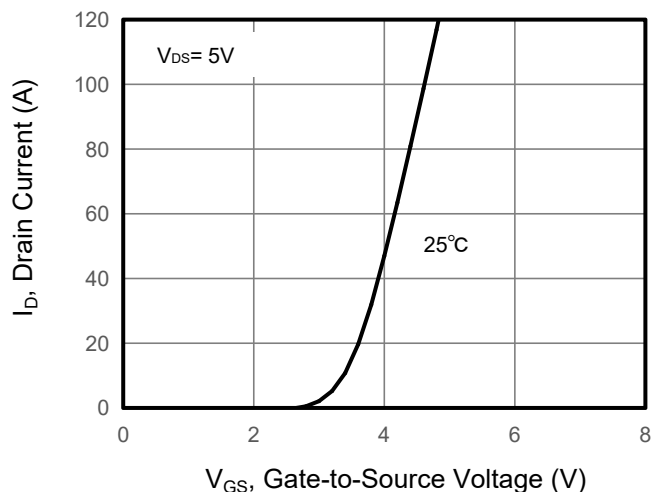

**Figure 3. Drain Source On Resistance**

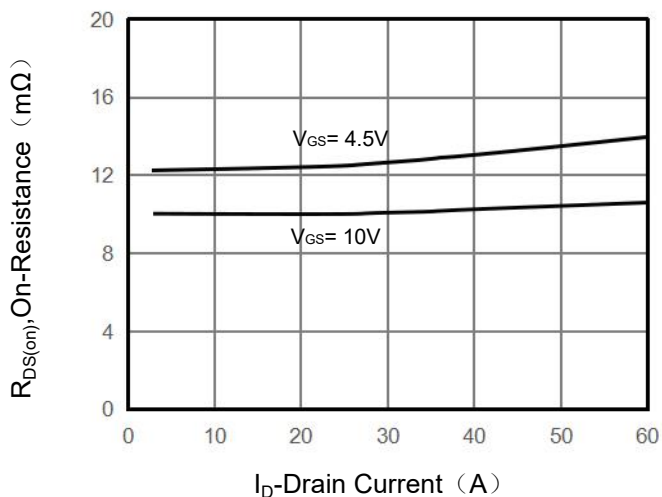

**Figure 4. Gate Charge**

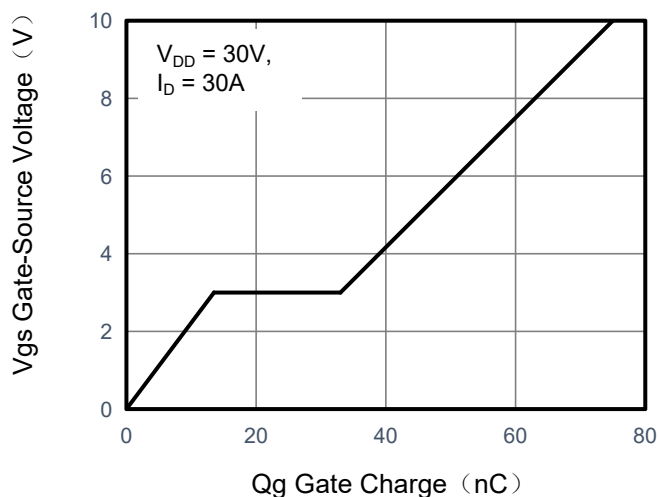

**Figure 5. Capacitance**

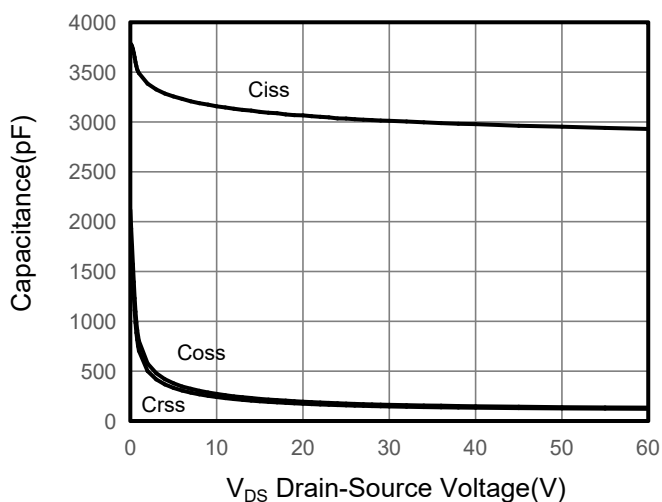

**Figure 6. Source-Drain Diode Forward**

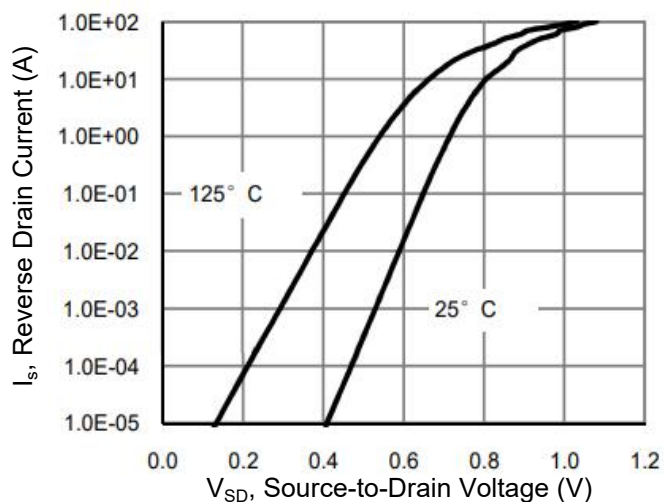

## Typical Characteristics $T_J = 25^\circ\text{C}$ , unless otherwise noted

Figure 7. Drain-Source On-Resistance

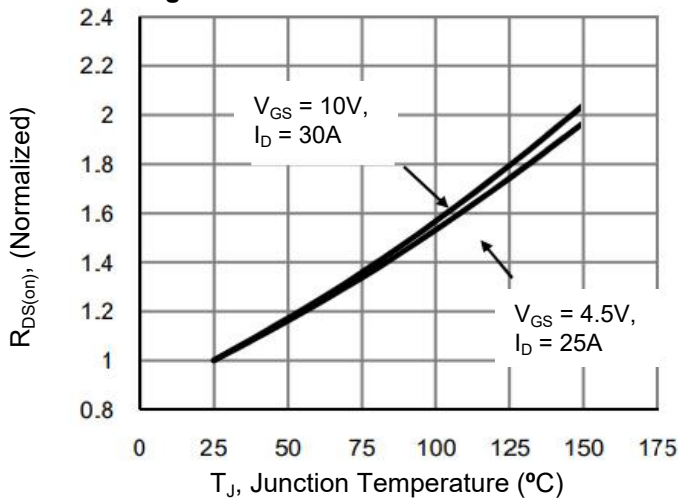

Figure 8. Safe Operation Area

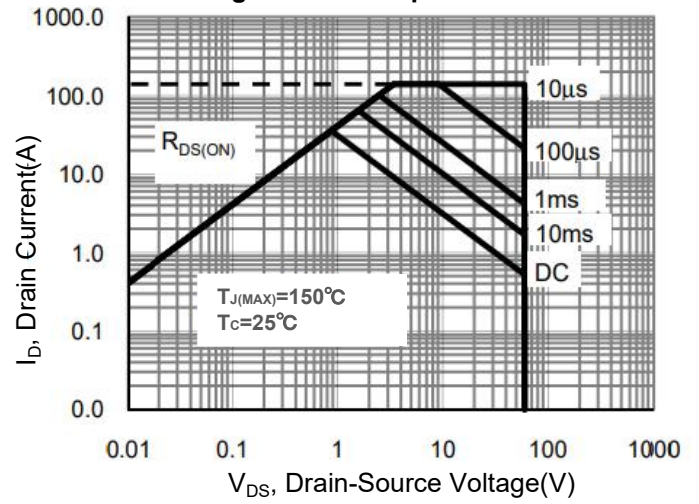
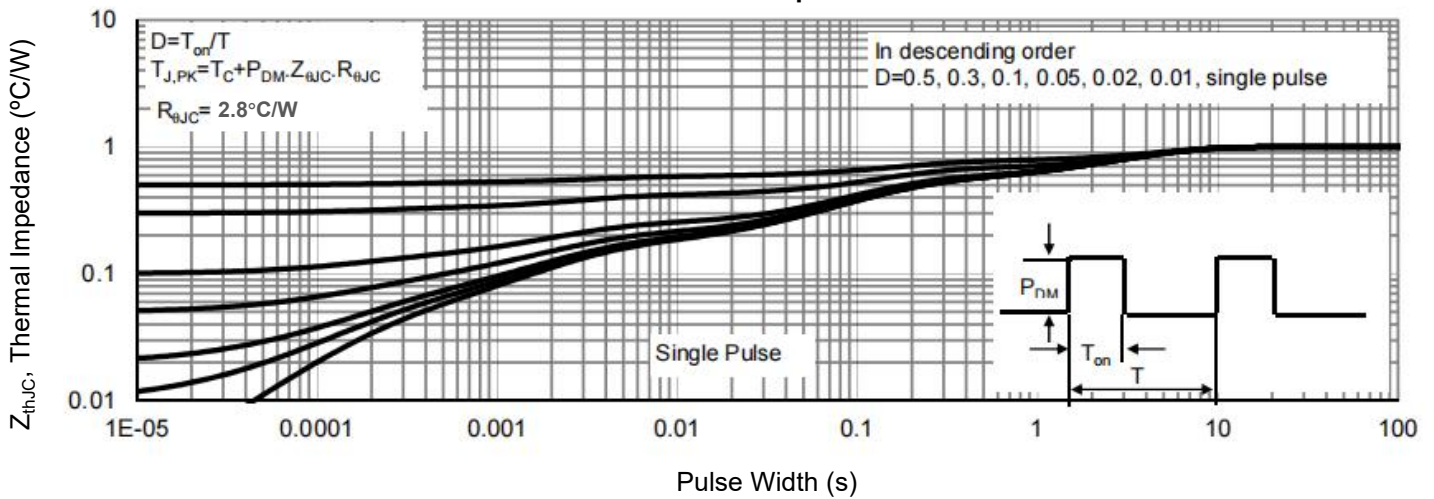
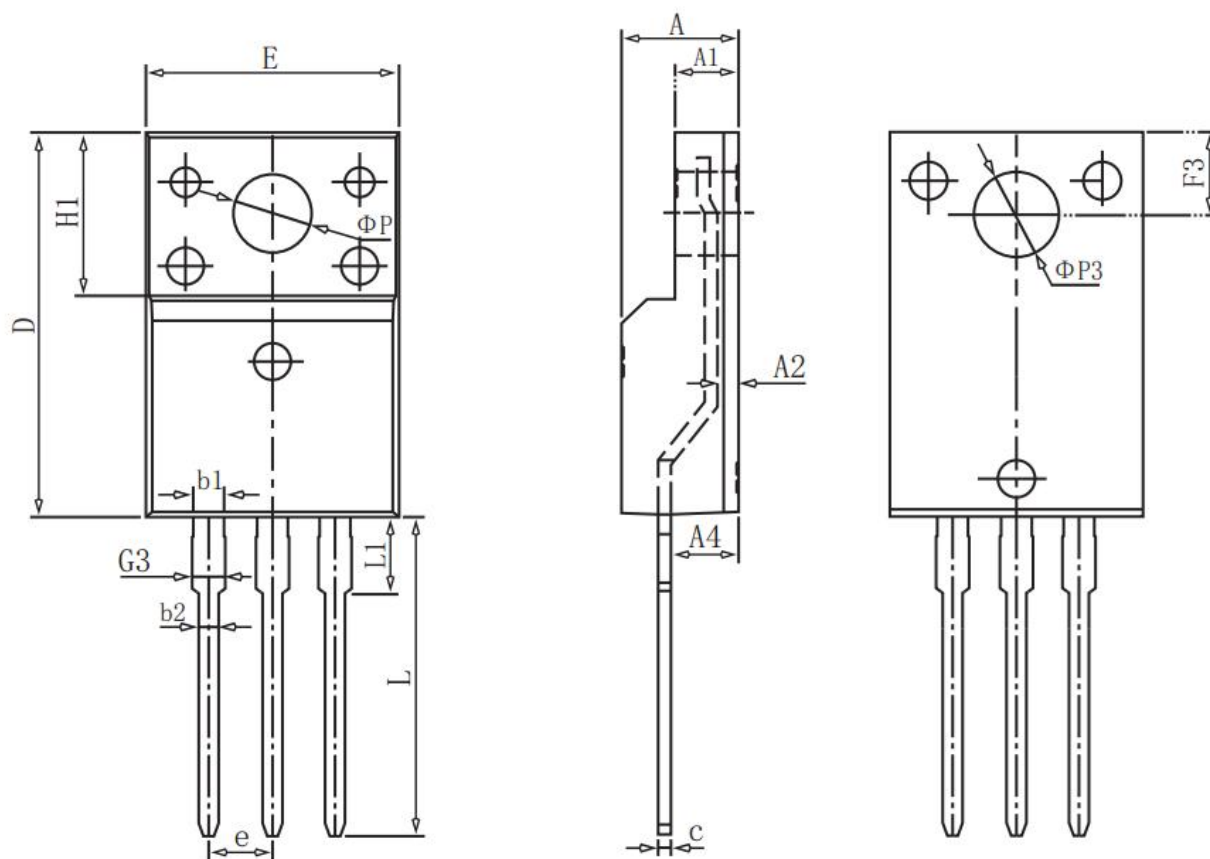

Figure 9. Normalized Maximum Transient Thermal Impedance



## TO-220F Package Information



### COMMON DIMENSIONS

SYMBOL	mm		
	MIN	NOM	MAX
E	10.00	10.20	10.40
A	4.50	4.70	4.90
A1	2.34	2.54	2.74
A2	0.65	0.85	1.30
A4	2.55	2.75	2.95
c	0.40	0.50	0.65
D	15.57	15.87	16.17
H1	6.70REF		
e	2.54BSC		
$\Phi P$	3.183REF		
L	12.68	12.98	13.28
L1	3.25	3.45	3.65
$\Phi P3$	3.45REF		
F3	3.10	3.30	3.50
G3	1.10	1.30	1.50
$b_1$	1.05	1.20	1.35
$b_2$	0.70	0.80	0.92