

--- C --- DCAH
 --- C --- DCBH
 --- C --- DCCH

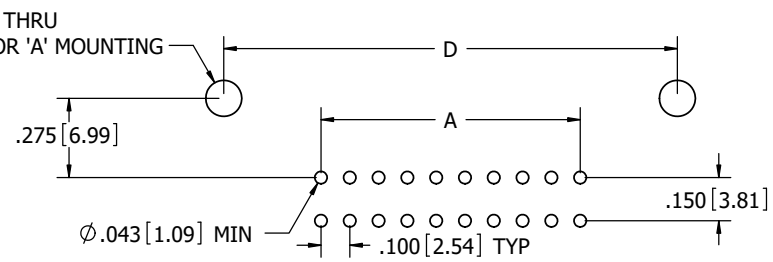

REVISIONS				
REV.	ECO. NO	DESCRIPTION	DATE	BY
C	2756	ADD CONTACT GAP DIMENSION, CONTACT IDs VIEW & UPDATE DWG FORMAT	6/11/2013	KV
D	3430	UPDATE DWG FORMAT, UPDATE BOM ON PRODUCTION DWG	4/29/2016	MG
E	4589	ADD 'A' MOUNTING, INSULATOR COLOR, REMOVE POSI 80, 90 & 100	10/25/2022	MM

- NOTES:
- INSULATOR MATERIAL: SEE PART NUMBER CODING
 - CONTACT MATERIAL: SEE PART NUMBER CODING
 - PLATING: SEE PART NUMBER CODING
 - OPERATING TEMPERATURE: SEE PART NUMBER CODING
 - PROCESSING TEMP: SEE PART NUMBER CODING
 - UL FLAMMABILITY RATING: 94V-0
 - OPERATING VOLTAGE: 700 VAC
 - CURRENT RATING: 3 AMP
 - CONTACT RESISTANCE: 30 MILLI OHMS MAX
 - INSULATION RESISTANCE: 5000 MEGA OHMS
 - DURABILITY: 500 CYCLES MINIMUM
 - CONNECTOR IDENTIFICATION: THE PART SHALL BE MARKED WITH A PART NUMBER AND LOT CODE
 - BOARD THICKNESS ACCOMMODATED: $.062 \pm .008 [1.57 \pm 0.20]$
 - INSERTION FORCE: 16 OZ MAX PER CONTACT PAIR WHEN USING A $.062 [1.57]$ TEST BLADE
INTERNAL INSPECTION TO BE PER SULLINS WORK INSTRUCTION WI-8.6-03
 - WITHDRAWAL FORCE: 1 OZ MIN PER CONTACT PAIR USING $.062 [1.57]$ TEST BLADE

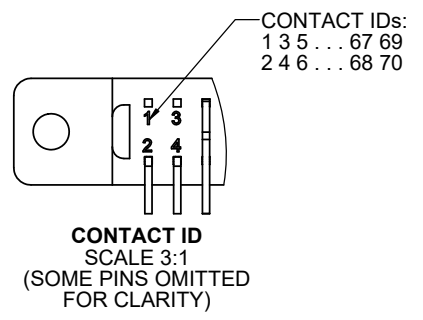
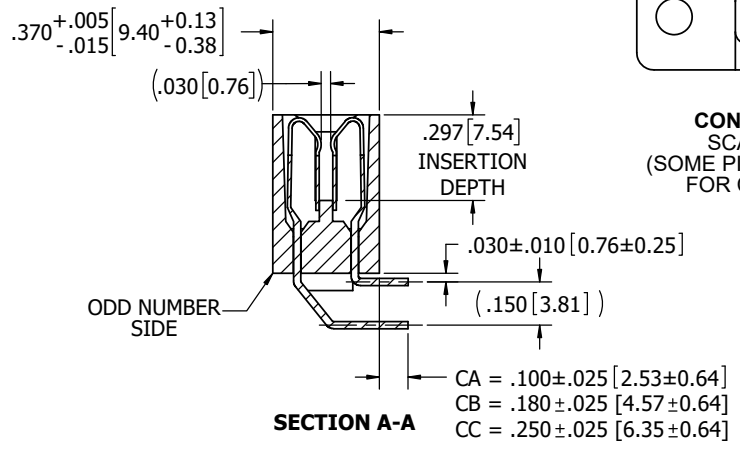

UNLESS OTHERWISE SPECIFIED:
DIMENSIONS ARE IN INCHES (MM)

TOLERANCES:
ANGULAR: $\pm 1^\circ$

DECIMALS
XX = $\pm .02 [5]$
XXX = $\pm .005 [13]$
XXXX = $\pm .0005 [13]$

DRAWN	DATE	NAME
	6/11/13	TT

THE INFORMATION HEREIN CONTAINS PROPRIETARY INFORMATION OF SULLINS ELECTRONICS AND IS NOT TO BE REPRODUCED, USED OR DISCLOSED TO OTHERS FOR ANY PURPOSE EXCEPT AS SPECIFICALLY AUTHORIZED IN WRITING BY AN OFFICER OF SULLINS ELECTRONICS.

SULLINS CONNECTOR SOLUTIONS			
TITLE EDGECARD, .100 CC, HP			
PART NUMBER _ C _ D (CA, CB, CC) _			
SIZE	CAGE CODE	DWG. NO.	REV
C	54453	C10923	E
SCALE: 3:1			SHEET 1 OF 3

CUSTOMER COPY

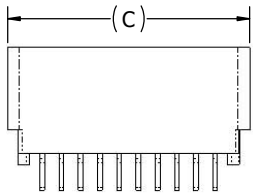
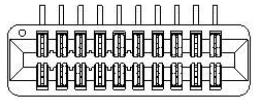

-C- DCAN
 -C- DCBN
 -C- DCCN

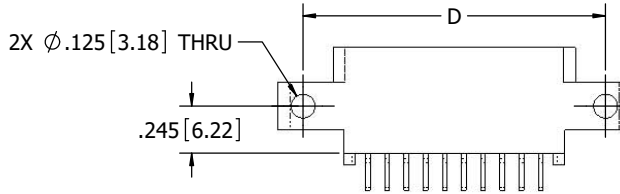
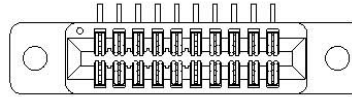

-C- DCAS
 -C- DCBS
 -C- DCCS

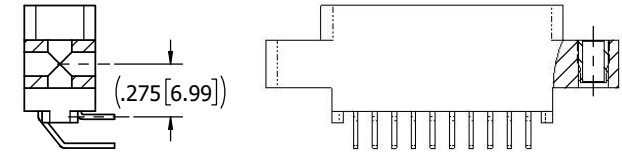
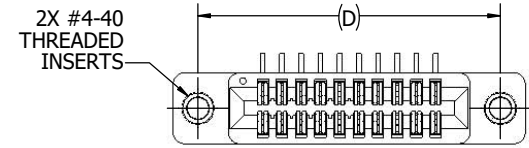

-C- DCAI
 -C- DCBI
 -C- DCCI

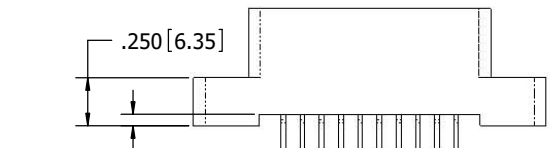
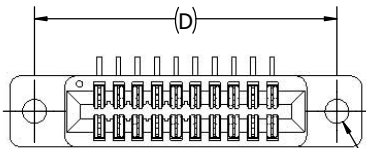

-C- DCAD
 -C- DCBD
 -C- DCCD

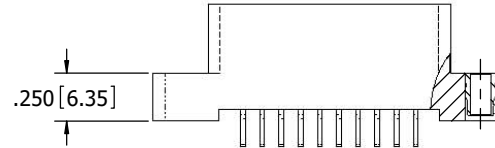
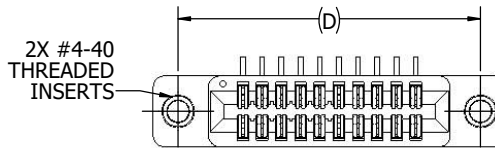

-C- DCAT
 -C- DCBT
 -C- DCCT

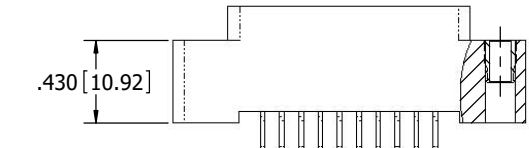
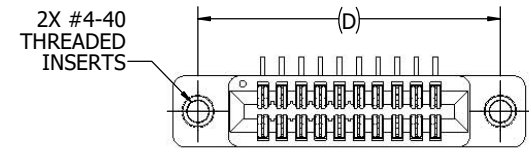

-C- DCAW
 -C- DCBW
 -C- DCCW

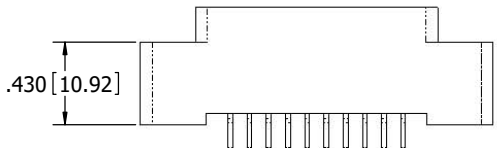
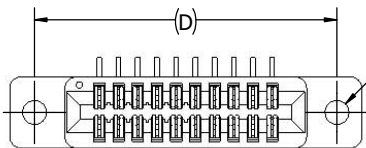

-C- DCAW
 -C- DCBW
 -C- DCCW

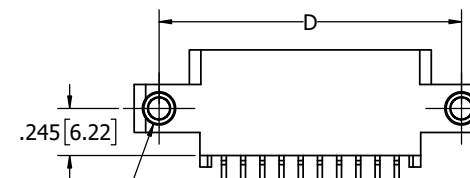
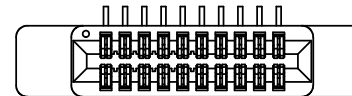

-C- DCAA
 -C- DCBA
 -C- DCCA



CUSTOMER COPY

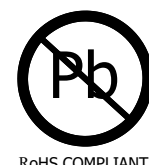

UNLESS OTHERWISE SPECIFIED:
DIMENSIONS ARE IN INCHES (MM)

TOLERANCES:
ANGULAR: ± 1°

DECIMALS
.XX = ± .02 [5]
.XXX = ± .005 [13]
.XXXX = ± .0005 [13]

DRAWN	DATE	NAME
	6/11/13	TT
THE INFORMATION HEREIN CONTAINS PROPRIETARY INFORMATION OF SULLINS ELECTRONICS AND IS NOT TO BE REPRODUCED, USED OR DISCLOSED TO OTHERS FOR ANY PURPOSE EXCEPT AS SPECIFICALLY AUTHORIZED IN WRITING BY AN OFFICER OF SULLINS ELECTRONICS.		
SULLINS CONNECTOR SOLUTIONS		
TITLE		
EDGE CARD, .100 CC, HP		
PART NUMBER		
-C- D(CA,CB,CC)-		
SIZE	CAGE CODE	DWG. NO.
C	54453	C10923
SCALE: 2:1		SHEET 2 OF 3

PART NUMBER	NO. OF POS.	A±.008[0.20]		B±.008[0.20]		C±.015[0.38]		D±.010[0.25]		E±.020[0.51]		F±.015[0.38]	
		INCH	MM	INCH	MM	INCH	MM	INCH	MM	INCH	MM	INCH	MM
C06D	6	0.500	12.70	0.700	17.78	0.860	21.84	1.175	29.85	1.435	36.45	0.750	19.05
C07D	7	0.600	15.24	0.800	20.32	0.960	24.38	1.275	32.39	1.535	38.99	0.850	21.59
C08D	8	0.700	17.78	0.900	22.86	1.060	26.92	1.375	34.93	1.635	41.53	0.950	24.13
C10D	10	0.900	22.86	1.100	27.94	1.260	32.00	1.575	40.01	1.835	46.61	1.150	29.21
C12D	12	1.100	27.94	1.300	33.02	1.460	37.08	1.775	45.09	2.035	51.69	1.350	34.29
C13D	13	1.200	30.48	1.400	35.56	1.560	39.62	1.875	47.63	2.135	54.23	1.450	36.83
C15D	15	1.400	35.56	1.600	40.64	1.760	44.70	2.075	52.71	2.335	59.31	1.650	41.91
C17D	17	1.600	40.64	1.800	45.72	1.960	49.78	2.275	57.79	2.535	64.39	1.850	46.99
C18D	18	1.700	43.18	1.900	48.26	2.060	52.32	2.375	60.33	2.635	66.93	1.950	49.53
C20D	20	1.900	48.26	2.100	53.34	2.260	57.40	2.575	65.41	2.835	72.01	2.150	54.61
C22D	22	2.100	53.34	2.300	58.42	2.460	62.48	2.775	70.49	3.035	77.09	2.350	59.69
C24D	24	2.300	58.42	2.500	63.50	2.660	67.56	2.975	75.57	3.235	82.17	2.550	64.77
C25D	25	2.400	60.96	2.600	66.04	2.760	70.10	3.075	78.11	3.335	84.71	2.650	67.31
C28D	28	2.700	68.58	2.900	73.66	3.060	77.72	3.375	85.73	3.635	92.33	2.950	74.93
C30D	30	2.900	73.66	3.100	78.74	3.260	82.80	3.575	90.81	3.835	97.41	3.150	80.01
C31D	31	3.000	76.20	3.200	81.28	3.360	85.34	3.675	93.35	3.935	99.95	3.250	82.55
C35D	35	3.400	86.36	3.600	91.44	3.760	95.50	4.075	103.51	4.335	110.11	3.650	92.71
C36D	36	3.500	88.90	3.700	93.98	3.860	98.04	4.175	106.05	4.435	112.65	3.750	95.25
C40D	40	3.900	99.06	4.100	104.14	4.260	108.20	4.575	116.21	4.835	122.81	4.150	105.41
C43D	43	4.200	106.68	4.400	111.76	4.560	115.82	4.875	123.83	5.135	130.43	4.450	113.03
C44D	44	4.300	109.22	4.500	114.30	4.660	118.36	4.975	126.37	5.235	132.97	4.550	115.57
C49D	49	4.800	121.92	5.000	127.00	5.160	131.06	5.475	139.07	5.735	145.67	5.050	128.27
C50D	50	4.900	124.46	5.100	129.54	5.260	133.60	5.575	141.61	5.835	148.21	5.150	130.81
C55D	55	5.400	137.16	5.600	142.24	5.760	146.30	6.075	154.31	6.335	160.91	5.650	143.51
C60D	60	5.900	149.86	6.100	154.94	6.260	159.00	6.575	167.01	6.835	173.61	6.150	156.21
C61D	61	6.000	152.40	6.200	157.48	6.360	161.54	6.675	169.55	6.935	176.15	6.250	158.75
C65D	65	6.400	162.56	6.600	167.64	6.760	171.70	7.075	179.71	7.335	186.31	6.650	168.91
C70D	70	6.900	175.26	7.100	180.34	7.260	184.40	7.575	192.41	7.835	199.01	7.150	181.61

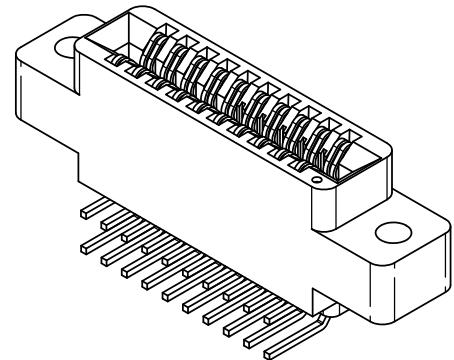

PART NUMBER CODING

MATERIAL (INSULATOR/CONTACT)
E = BLUE PBT/PHOSPHOR BRONZE
 OPERATING TEMP: -65°C TO +125°C
 PROCESSING TEMP: WAVE/MANUAL SOLDERING ONLY
R = GREEN PPS/PHOSPHOR BRONZE
 OPERATING TEMP: -65°C TO +125°C
 PROCESSING TEMP: 260°C MAX FOR 20 SECS
G = BLACK PA9T/PHOSPHOR BRONZE
 OPERATING TEMP: -65°C TO +125°C
 PROCESSING TEMP: 260°C MAX FOR 20 SECS
 (CONSULT FACTORY FOR OTHER MATERIALS)

MOUNTING STYLE
 H = .125 DIA. CLEARANCE HOLES
 I = #4-40 THREADED INSERT
 S = .125 DIA. SIDE MOUNTING
 N = NO MOUNTING EARS
 D = .250 FLUSH MOUNTING
 W = .430 FLUSH MOUNTING
 T = .250 FLUSH MTG. WITH THREAD INSERT
 X = .430 FLUSH MTG. WITH THREAD INSERT
 A = #4-40 THREADED INSERT IN SIDE HOLES

TERMINATION TYPE (LENGTH)
 CA = .100" (SEE SECTION A-A FOR DETAILS)
 CB = .180" (SEE SECTION A-A FOR DETAILS)
 CC = .250" (SEE SECTION A-A FOR DETAILS)

NUMBER OF POSITIONS (CONTACTS PER ROW)

PLATING
 ALL PLATINGS ARE LEAD FREE AND HAVE .000050" NICKEL UNDERPLATE

CONTACT SURFACE
 B = .000100" GOLD
 C = .000030" GOLD

TERMINATION
 .000100" PURE TIN, MATTE
 .000100" PURE TIN, MATTE



RoHS COMPLIANT

UNLESS OTHERWISE SPECIFIED:
 DIMENSIONS ARE IN INCHES (MM)

TOLERANCES:
 ANGULAR: ± 1°
 DECIMALS
 .XX = ± .02 [5]
 .XXX = ± .005 [13]
 .XXXX = ± .0005 [013]

DRAWN	DATE	NAME
	6/11/13	TT
<small>THE INFORMATION HEREIN CONTAINS PROPRIETARY INFORMATION OF SULLINS ELECTRONICS AND IS NOT TO BE REPRODUCED, USED OR DISCLOSED TO OTHERS FOR ANY PURPOSE EXCEPT AS SPECIFICALLY AUTHORIZED IN WRITING BY AN OFFICER OF SULLINS ELECTRONICS.</small>		
TITLE EDGECARD, .100 CC, HP		
PART NUMBER _ C _ D (CA, CB, CC) _		
SIZE	CAGE CODE	DWG. NO.
C	54453	C10923
SCALE: 4:1		REV
		E
		SHEET 3 OF 3

CUSTOMER COPY