

ESD108-B1-CSP0201

Protection device

TVS (transient voltage suppressor)

Bi-directional, 5.5 V, 0.28 pF, 0201, RoHS and halogen free compliant

Features

- ESD/transient protection of high speed data lines according to:
 - IEC61000-4-2 (ESD): ± 25 kV (air/contact discharge)
 - IEC61000-4-4 (EFT): ± 2.5 kV/ ± 50 A (5/50 ns)
 - IEC61000-4-5 (Surge): ± 2.5 A (8/20 μ s)
- Bi-directional working voltage up to: $V_{RWM} = \pm 5.5$ V
- Line capacitance: $C_L = 0.28$ pF (typical) at $f = 1$ MHz
- Clamping voltage: $V_{CL} = 20$ V (typical) at $I_{TLP} = 16$ A with $R_{DYN} = 0.78 \Omega$ (typical)
- Very low reverse current: $I_R < 1$ nA (typical)
- Small form factor SMD size 0201 and low profile (0.58 mm x 0.28 mm x 0.15 mm); for further package information please refer to application note AN392 [4]
- Bi-directional and symmetric I/V characteristics for optimized design/assembly



Potential applications

- USB 3.0, Firewire, DVI, HDMI, S-ATA, DisplayPort, Thunderbolt
- Mobile HDMI Link, MDDI, MIPI, SWP / NFC

Product validation

Qualified for industrial applications according to the relevant tests of JEDEC47/20/22

Device information

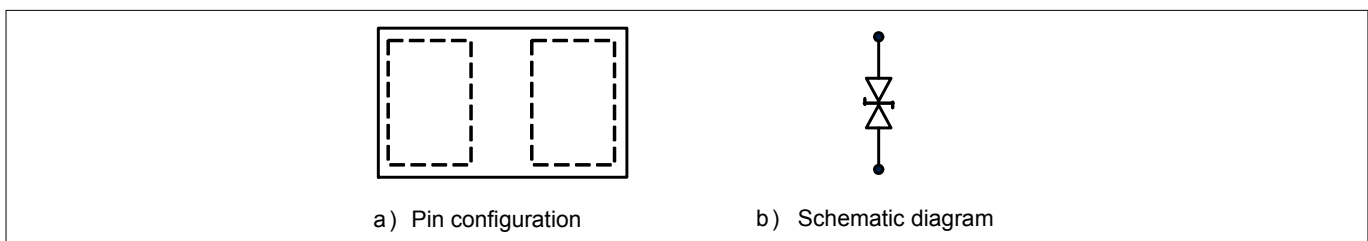

Figure 1 Pin configuration and schematic diagram

Table 1 Part information

Type	Package	Configuration	Marking code
ESD108-B1-CSP0201	WLL-2-1	1 line, bi-directional	C ¹⁾

¹ The device has no marking or date code on the device backside. The marking code is on pad side.

Table of contents

	Features	1
	Potential applications	1
	Product validation	1
	Device information	1
	Table of contents	2
1	Maximum ratings	3
2	Electrical characteristics	4
3	Typical characteristic diagrams	6
4	Package information	13
4.1	WLL-2-1 package	13
5	References	14
	Revision history	14
	Disclaimer	15

Maximum ratings

1 Maximum ratings

Note: $T_A = 25\text{ °C}$, unless otherwise specified.

Table 2 Maximum ratings

Parameter	Symbol	Values	Unit	Note or test condition
Reverse working voltage	V_{RWM}	±5.5	V	–
ESD (air/contact) discharge ¹⁾	V_{ESD}	±25	kV	–
Reverse working current	I_{RWM}	10	mA	–
Peak pulse power	P_{PK}	27.5	W	$t_p = 8/20\ \mu\text{s}$ ²⁾
		18	kW	$t_p = 100\ \text{ns}$ ¹⁾
Peak pulse current ²⁾	I_{PP}	±2.5	A	–
Operating temperature range	T_{OP}	-55 to 125	°C	–
Storage temperature	T_{stg}	-65 to 150	°C	–

Attention: Stresses above the maximum values listed here may cause permanent damage to the device. Exposure to absolute maximum rating conditions for extended periods may affect device reliability. Maximum ratings are absolute ratings. Exceeding only one of these values may cause irreversible damage to the component.

Table 3 Thermal resistance

Parameter	Symbol	Values			Unit	Note or test condition
		Min.	Typ.	Max.		
Junction - soldering point ³⁾	R_{thJS}	–	–	330	K/W	–

¹ V_{ESD} according to IEC61000-4-2 ($R = 330\ \Omega$, $C = 150\ \text{pF}$ discharge network)

² Stress pulse: 8/20 μs current waveform according to IEC61000-4-5

³ For calculation of R_{thJA} please refer to application note AN077 [3]: Thermal resistance calculation

Electrical characteristics

2 Electrical characteristics

Note: $T_A = 25\text{ }^\circ\text{C}$, unless otherwise specified. Device is electrically symmetrical.

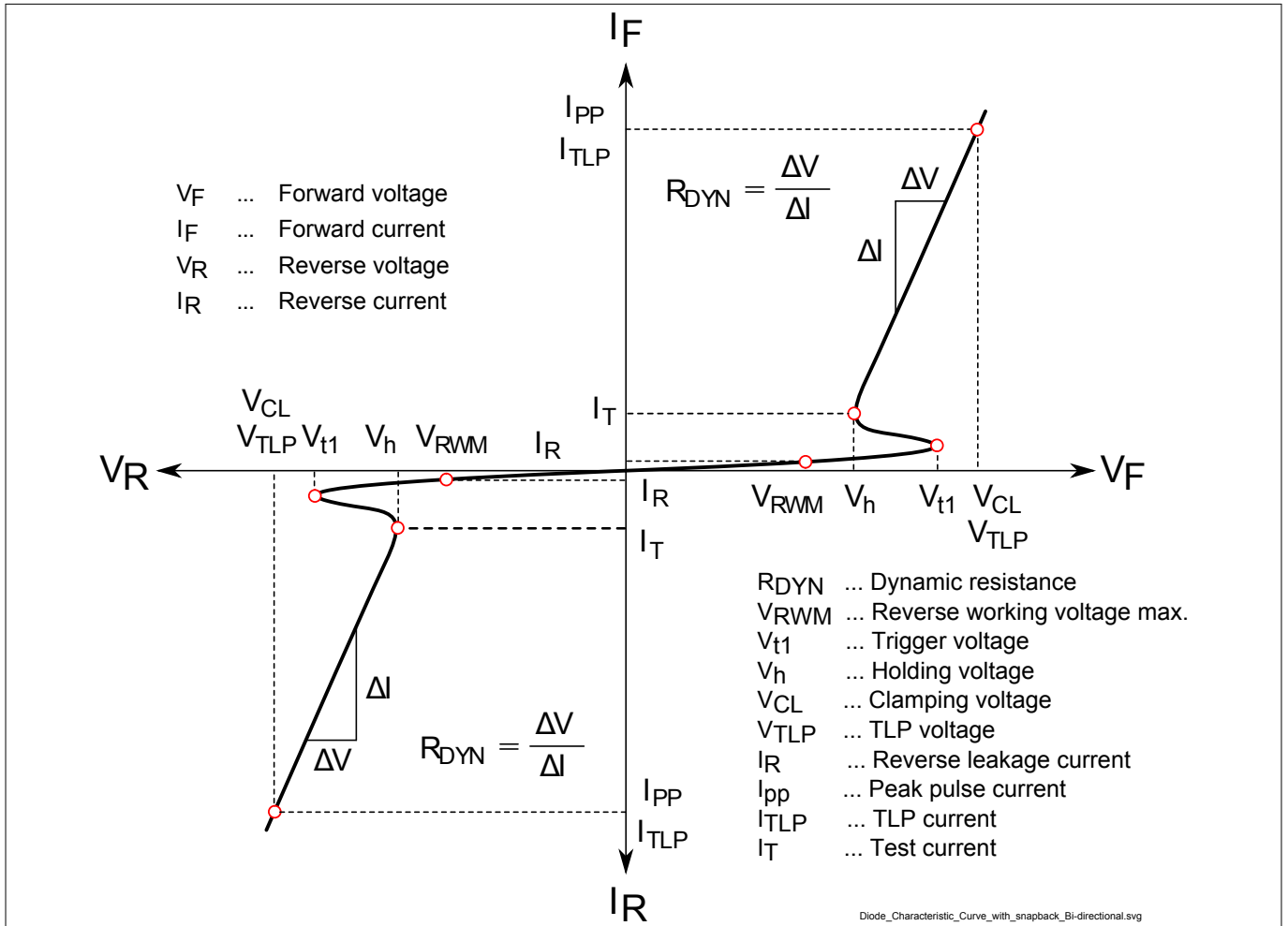

Figure 2 Definitions of electrical characteristics

Electrical characteristics

Table 4 DC characteristics

Parameter	Symbol	Values			Unit	Note or test condition
		Min.	Typ.	Max.		
Reverse current	I_R	–	<1	20	nA	$V_R = \pm 5.5 \text{ V}$
Trigger voltage	V_{t1}	–	9.5	12.5	V	
Holding voltage	V_h	5.5	6.5	9.5	V	$I_T = 0.5 \text{ mA}$

Table 5 AC characteristics

Parameter	Symbol	Values			Unit	Note or test condition
		Min.	Typ.	Max.		
Line capacitance	C_L	–	0.28	0.38	pF	$V_R = 0 \text{ V}, f = 1 \text{ MHz}$
		–	0.22	0.38		$V_R = 0 \text{ V}, f = 1 \text{ GHz}$

Table 6 ESD and Surge characteristics

Parameter	Symbol	Values			Unit	Note or test condition
		Min.	Typ.	Max.		
Clamping voltage ¹⁾	V_{CL}	–	20	27	V	$I_{TLP} = 16 \text{ A}, t_p = 100 \text{ ns}$
		–	30.5	41		$I_{TLP} = 30 \text{ A}, t_p = 100 \text{ ns}$
Clamping voltage ²⁾	V_{CL}	–	20	–	V	$V_{ESD} = 8 \text{ kV}$
		–	29	–		$V_{ESD} = 15 \text{ kV}$
Clamping voltage ³⁾	V_{CL}	–	8.5	12	V	$I_{PP} = 1 \text{ A}, t_p = 8/20 \mu\text{s}$
		–	11	18.5		$I_{PP} = 2.5 \text{ A}, t_p = 8/20 \mu\text{s}$
Dynamic resistance ¹⁾	R_{DYN}	–	0.78	–	Ω	$t_p = 100 \text{ ns}$

¹ Please refer to application note AN210 [1], TLP parameters: $Z_0 = 50 \Omega$, $t_p = 100 \text{ ns}$, $t_r = 0.6 \text{ ns}$

² V_{ESD} according to IEC61000-4-2 (contact discharge), V_{CL} at 30 ns ($R = 330 \Omega$, $C = 150 \text{ pF}$ discharge network)

³ Stress pulse: 8/20 μs current waveform according to IEC61000-4-5

Typical characteristic diagrams

3 Typical characteristic diagrams

Note: $T_A = 25\text{ }^\circ\text{C}$, unless otherwise specified.

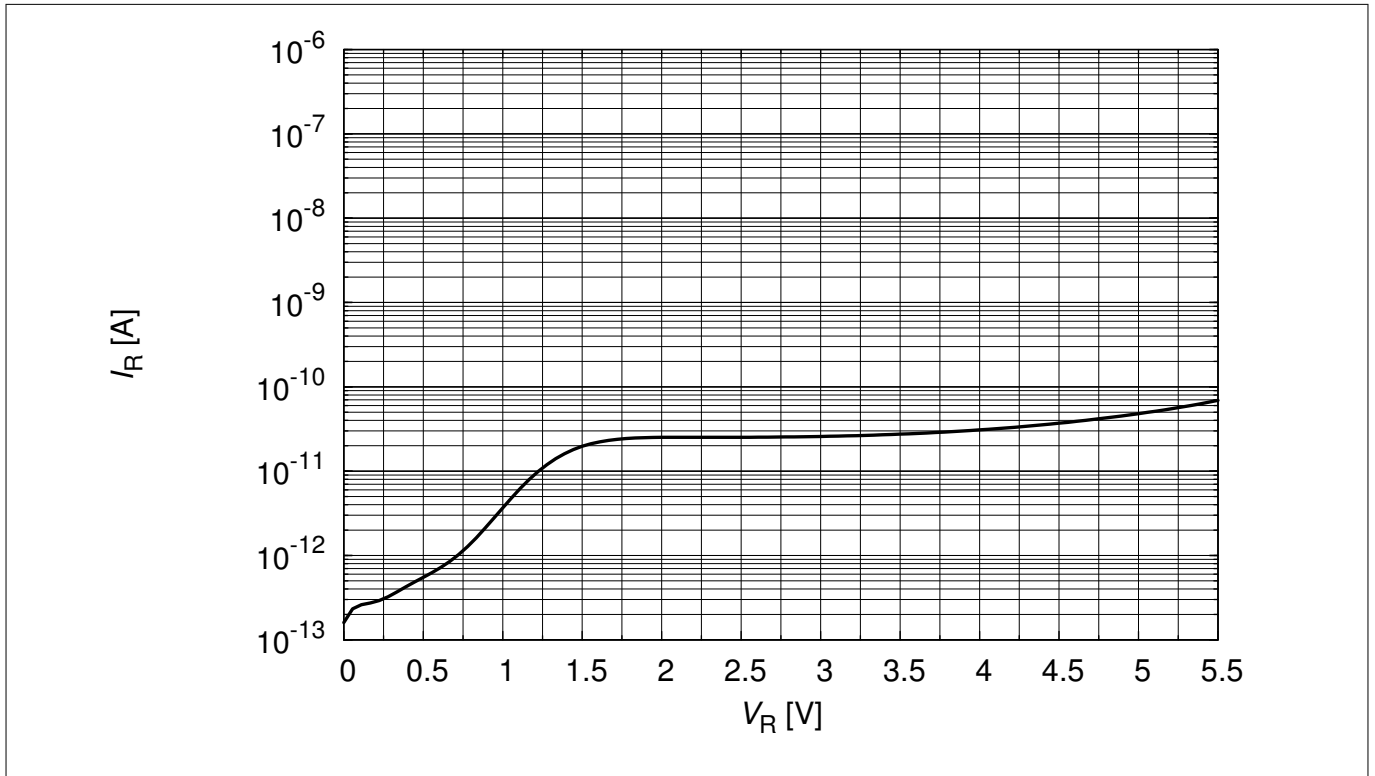

Figure 3 Reverse leakage current: $I_R = f(V_R)$

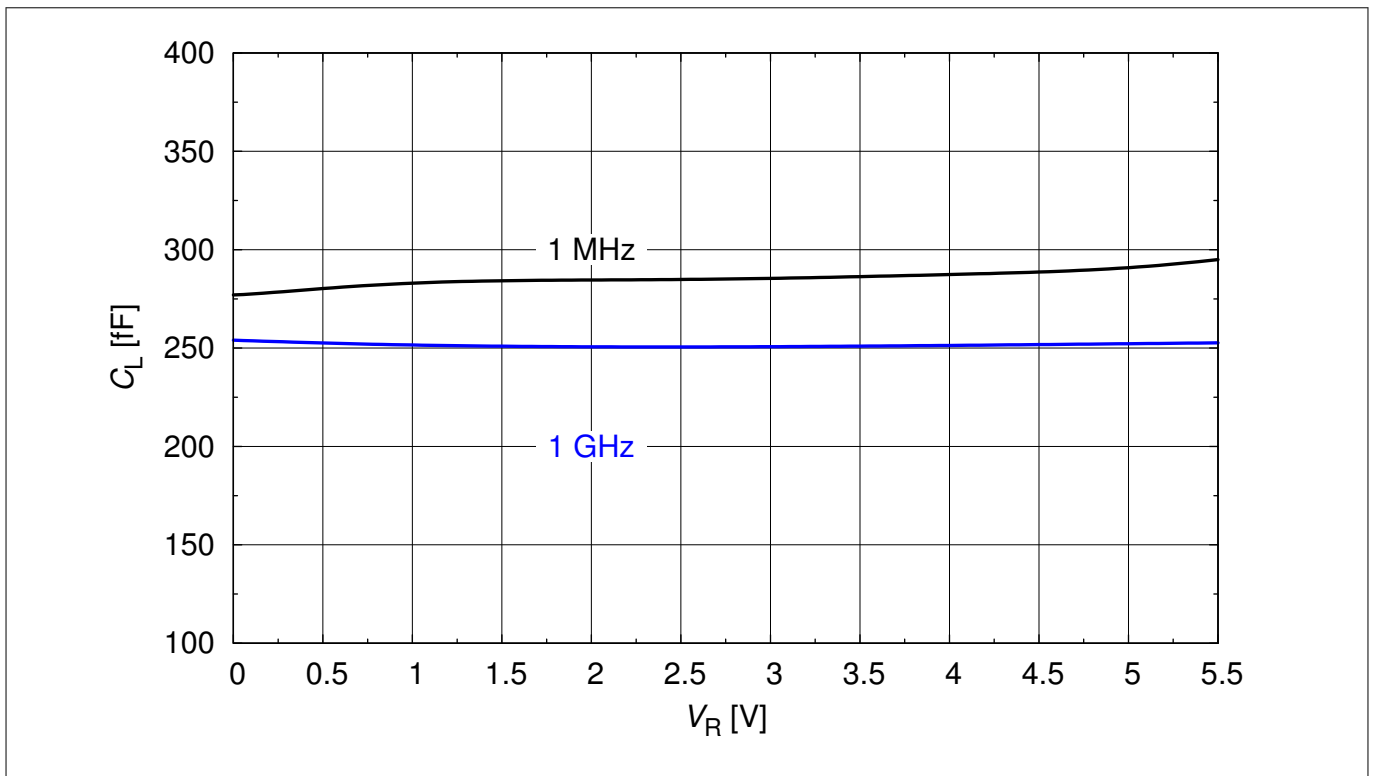

Figure 4 Line capacitance: $C_L = f(V_R)$

Typical characteristic diagrams

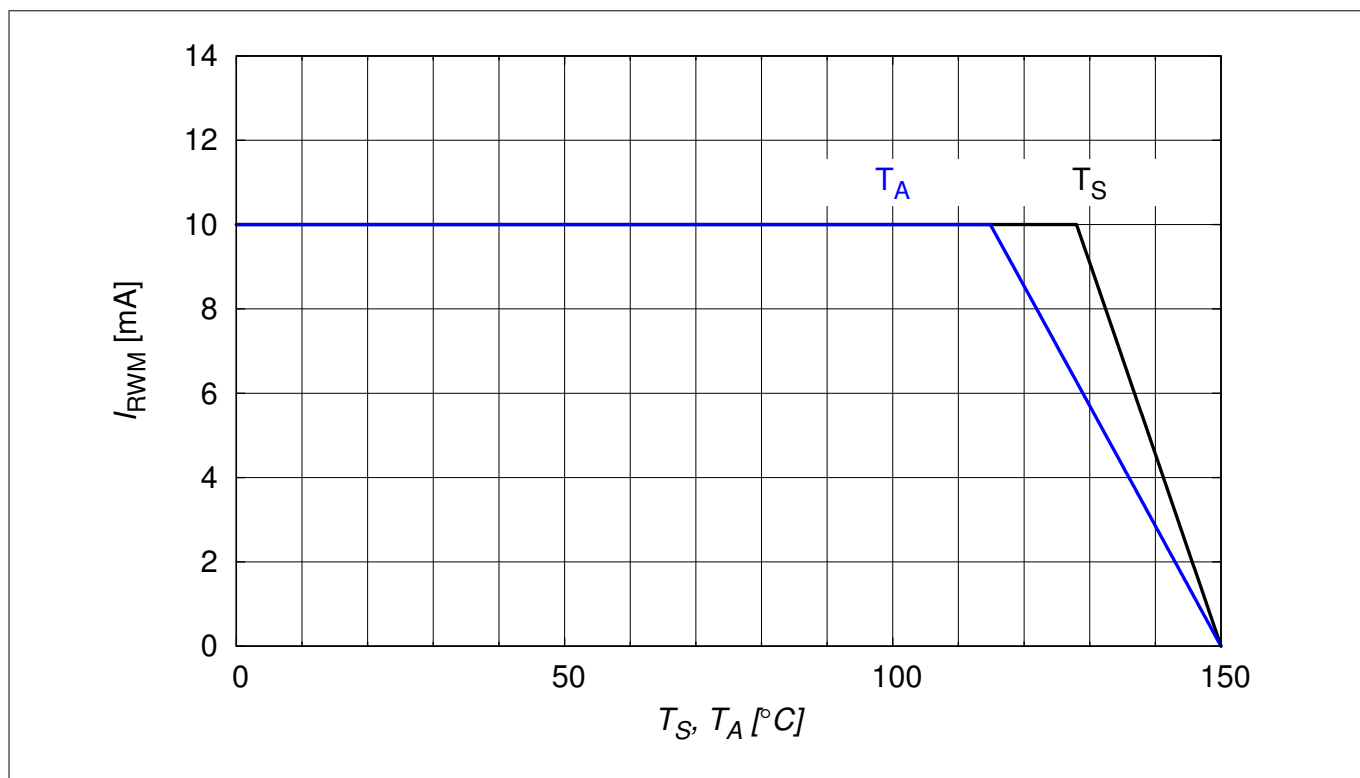

Figure 5 Reverse working current $I_{RWM} = f(T_S, T_A)$, device mounted on PCB with $R_{th} = 200$ K/W [3]

Typical characteristic diagrams

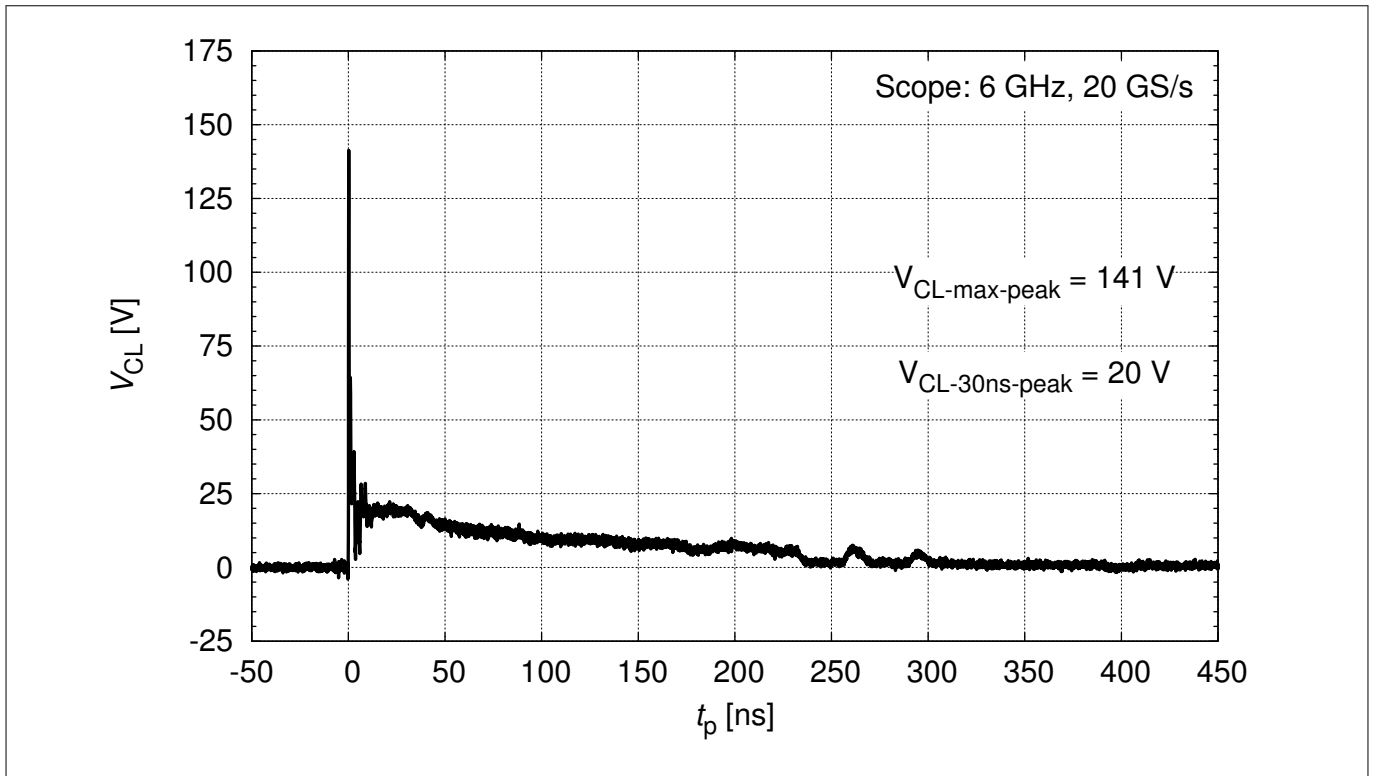

Figure 6 Clamping voltage (ESD): $V_{CL} = f(t)$, 8 kV positive pulse (according to IEC61000-4-2)

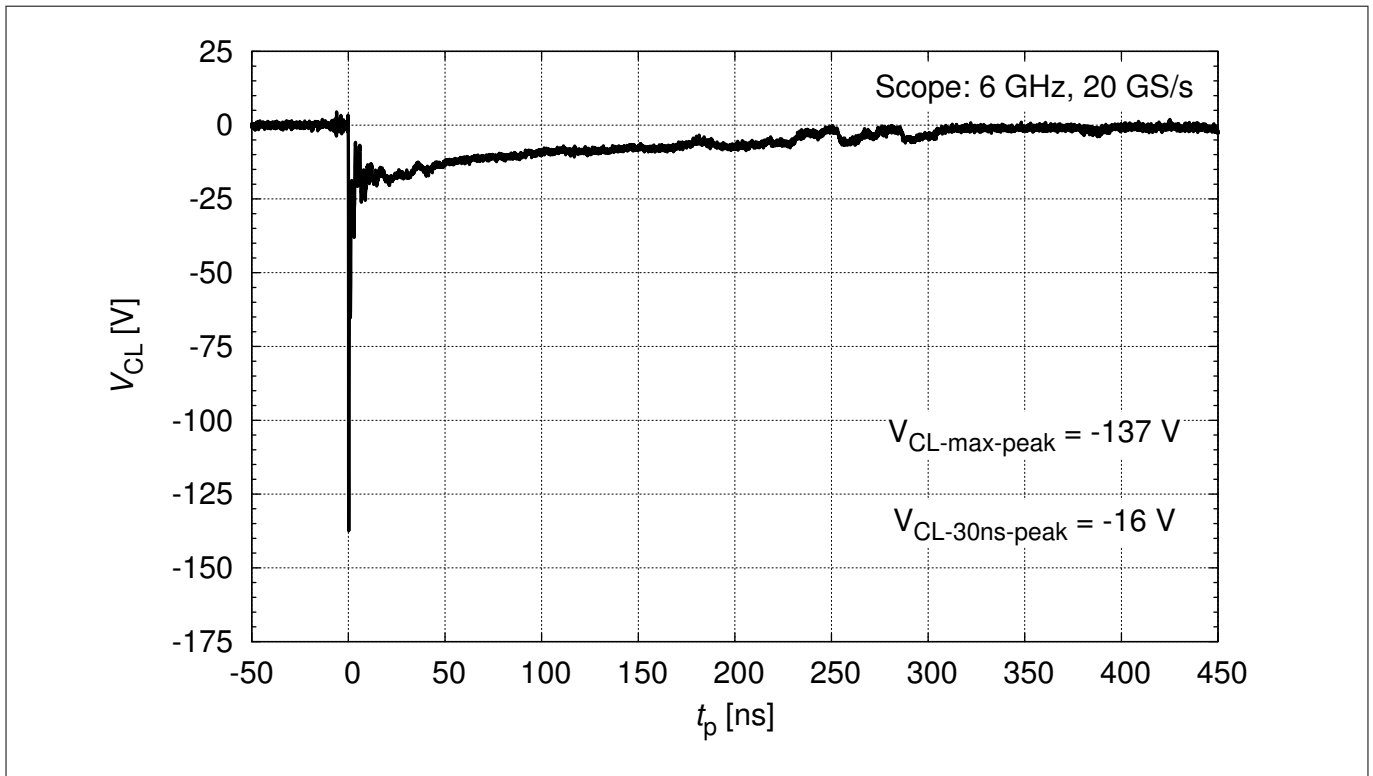

Figure 7 Clamping voltage (ESD): $V_{CL} = f(t)$, 8 kV negative pulse (according to IEC61000-4-2)

Typical characteristic diagrams

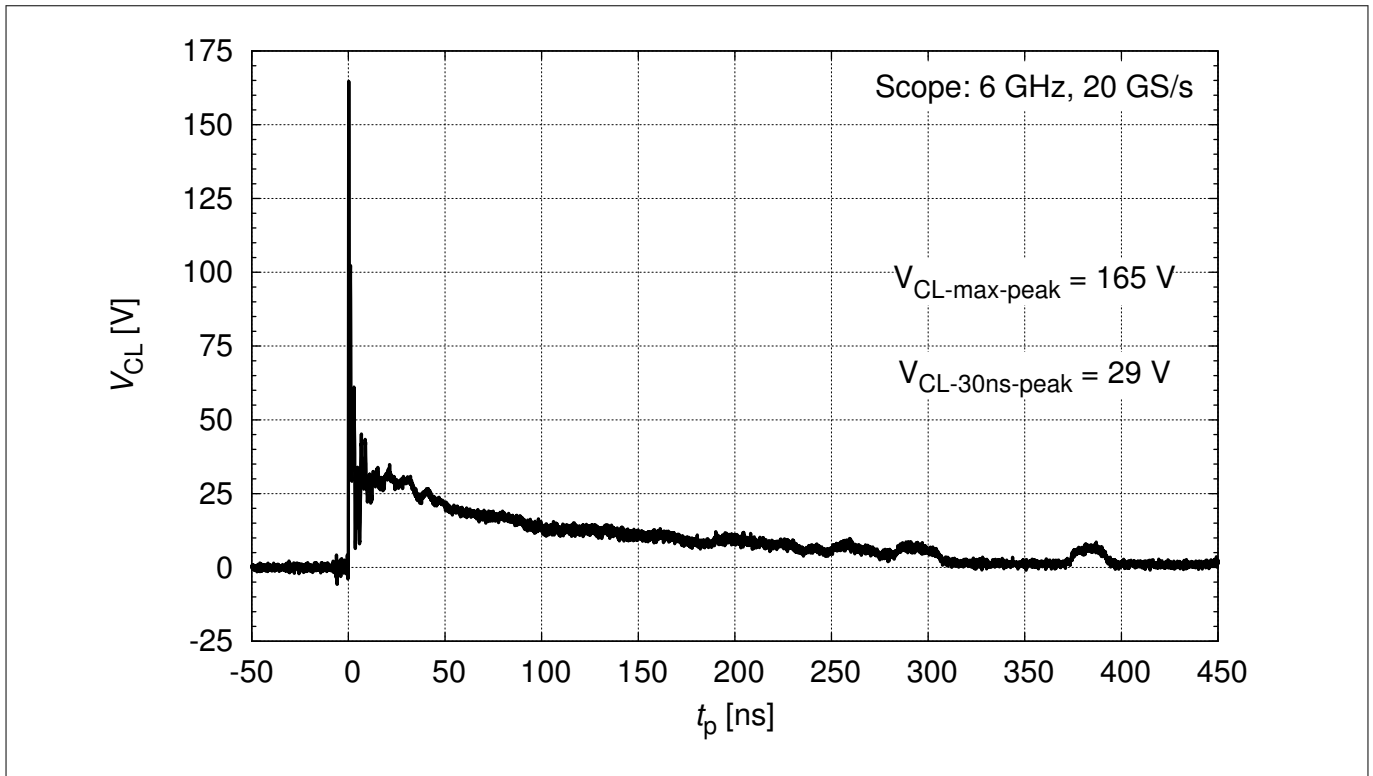

Figure 8 Clamping voltage (ESD): $V_{CL} = f(t)$, 15 kV positive pulse (according to IEC61000-4-2)

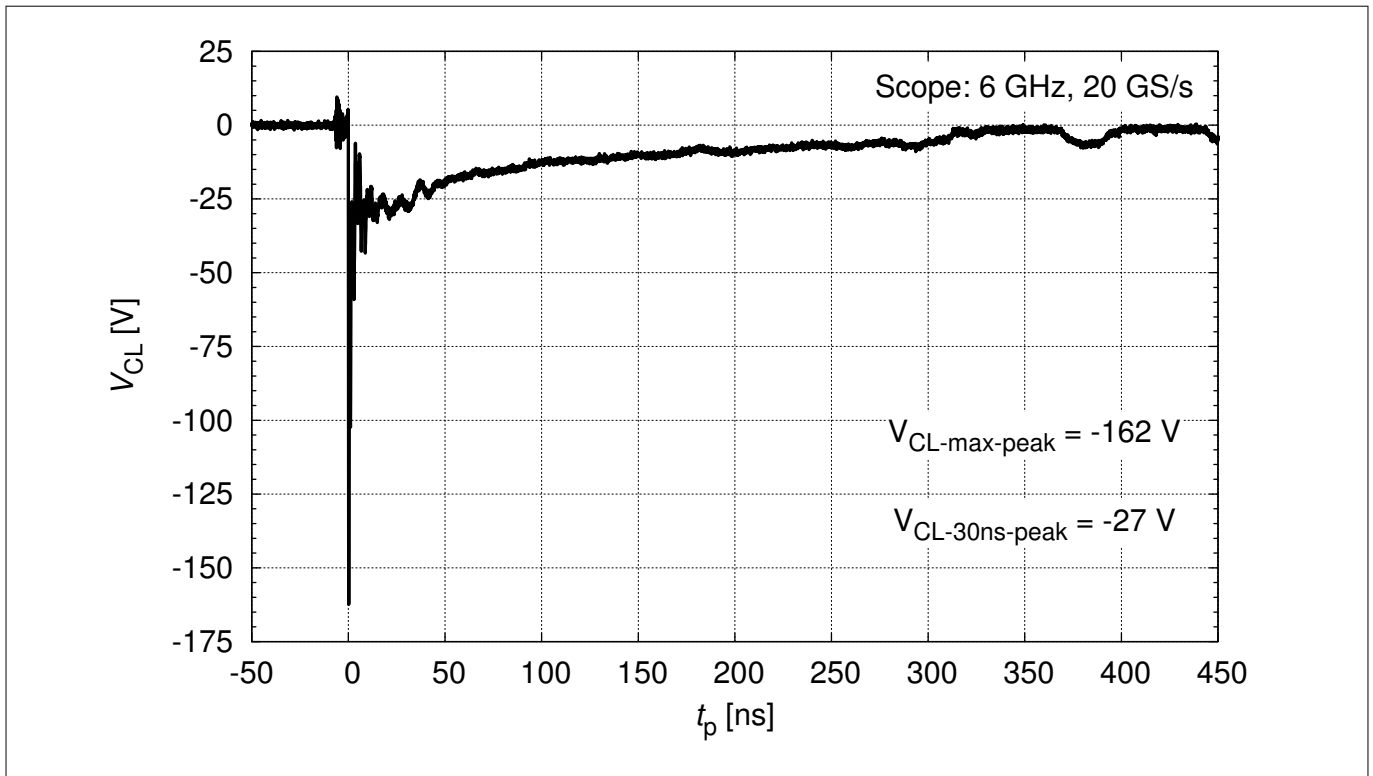

Figure 9 Clamping voltage (ESD): $V_{CL} = f(t)$, 15 kV negative pulse (according to IEC61000-4-2)

Typical characteristic diagrams

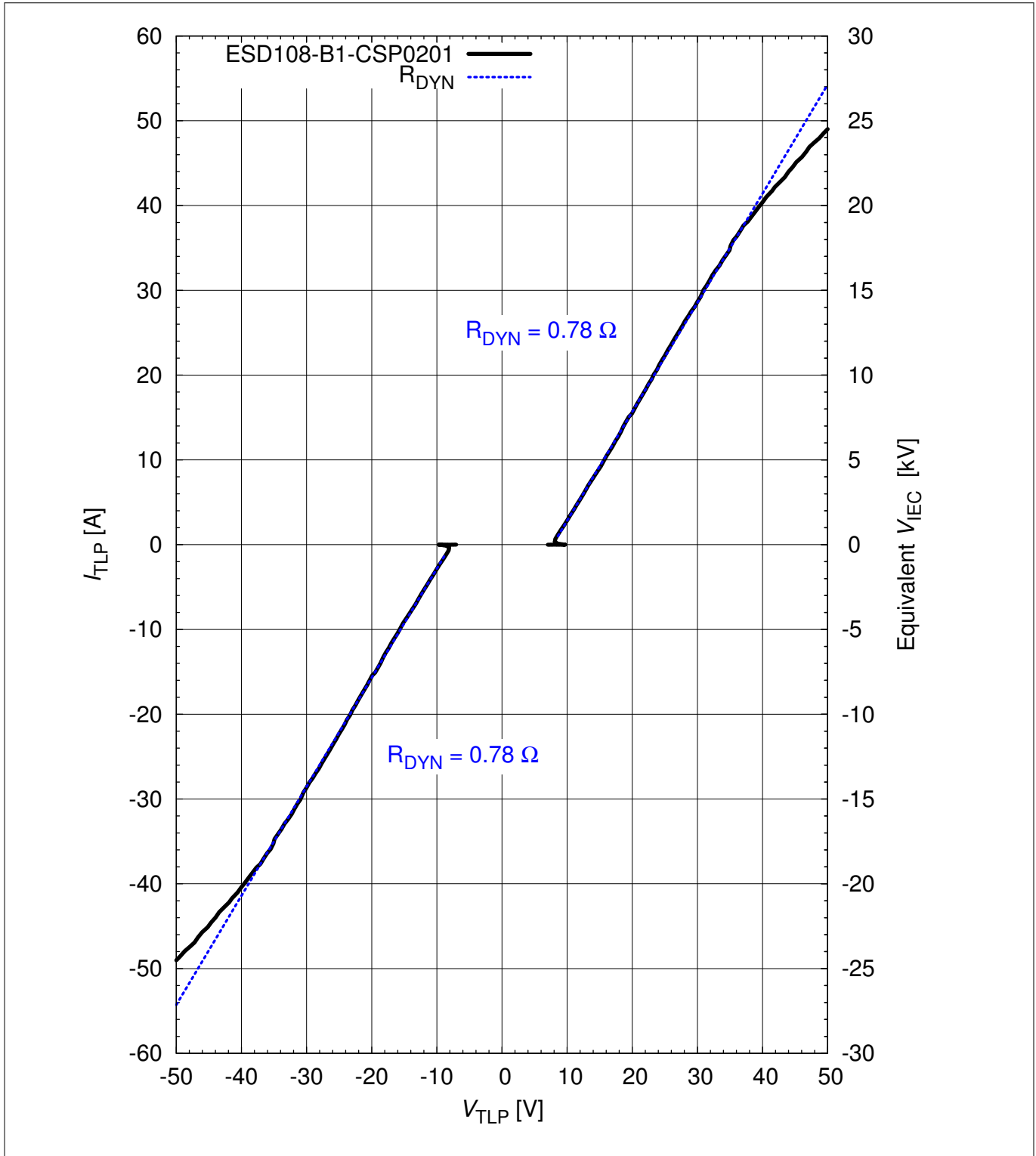

Figure 10 Clamping voltage (TLP): $I_{TLP} = f(V_{TLP})$ [1]

Typical characteristic diagrams

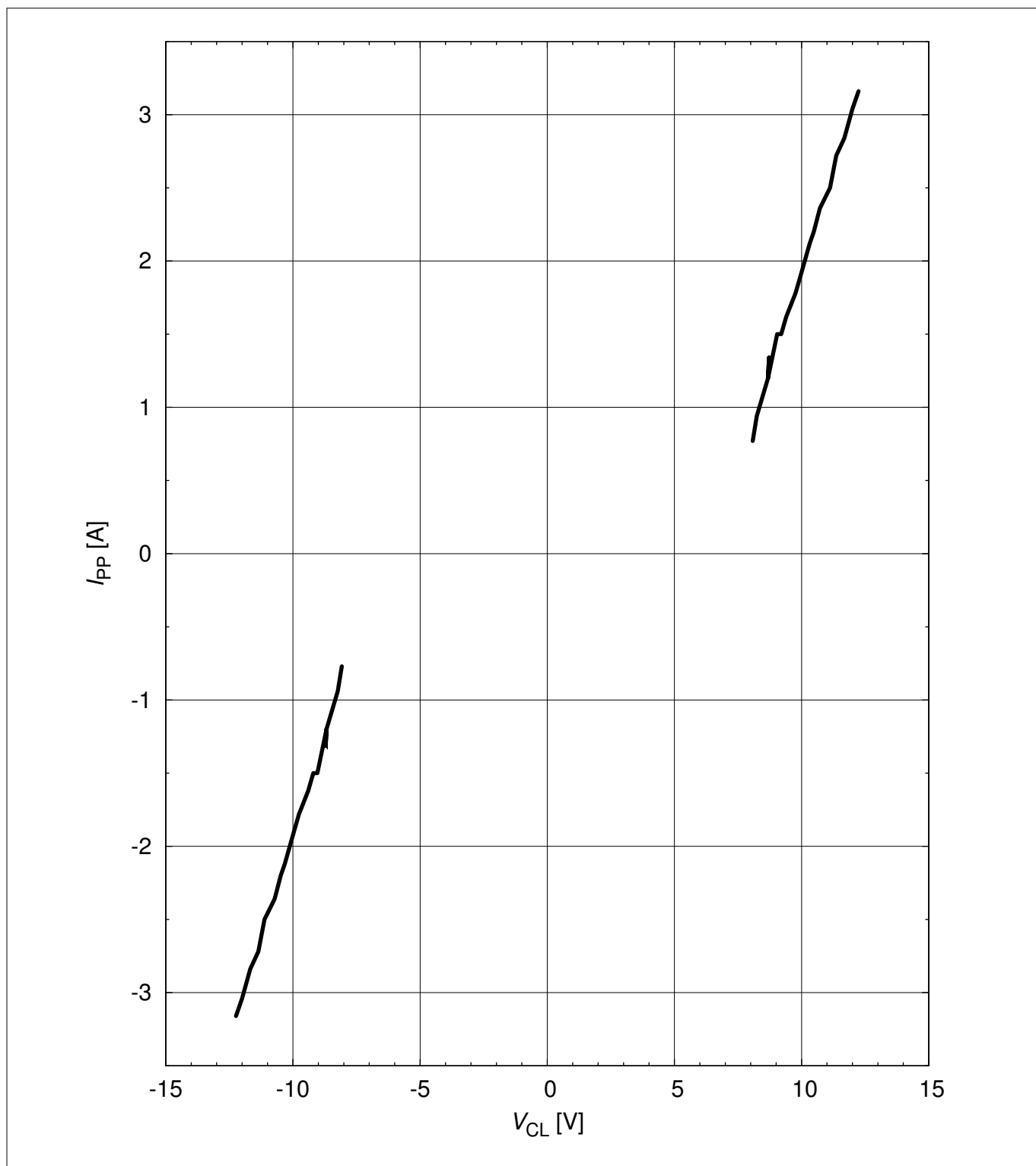

Figure 11 Clamping voltage (Surge): $I_{PP} = f(V_{CL})$ (according to IEC61000-4-5) [1]

Typical characteristic diagrams

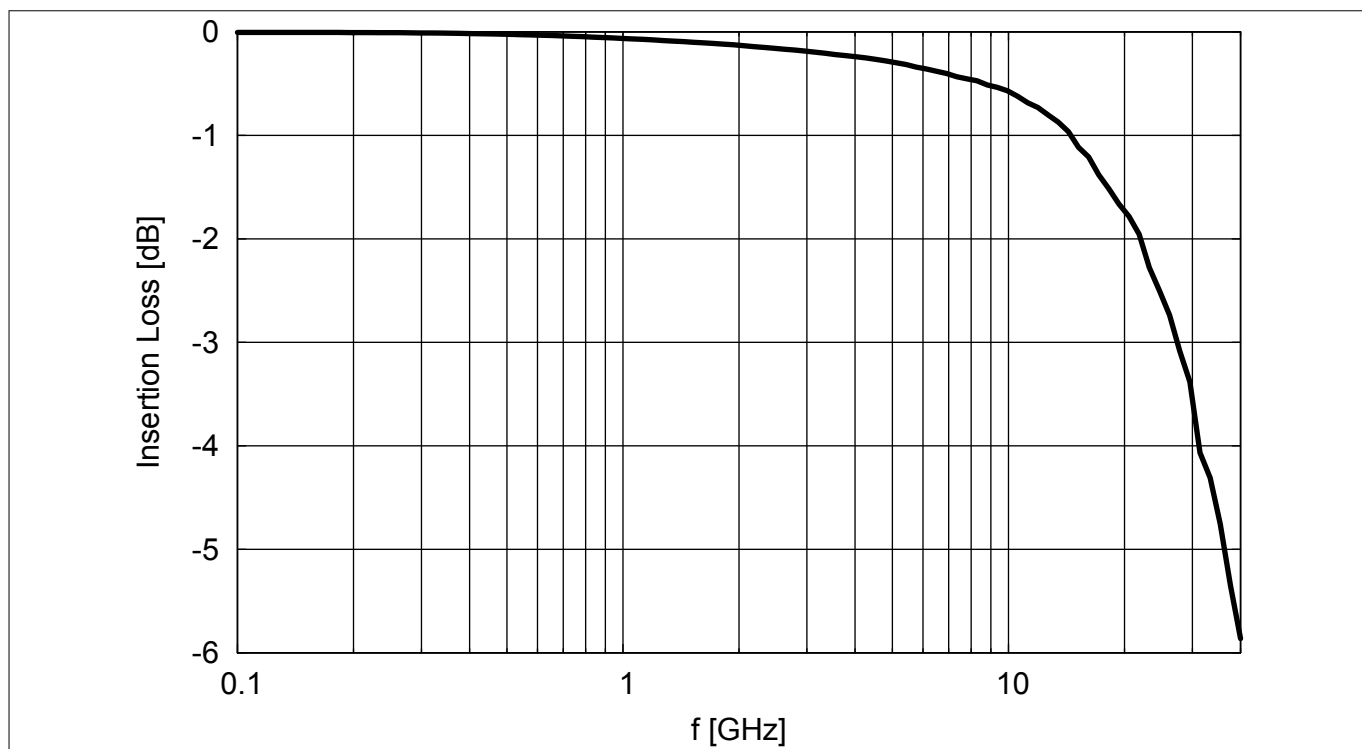

Figure 12 Insertion loss vs. frequency in a 50 Ω system

Package information

4 Package information

4.1 WLL-2-1 package

Note: Dimensions in mm.

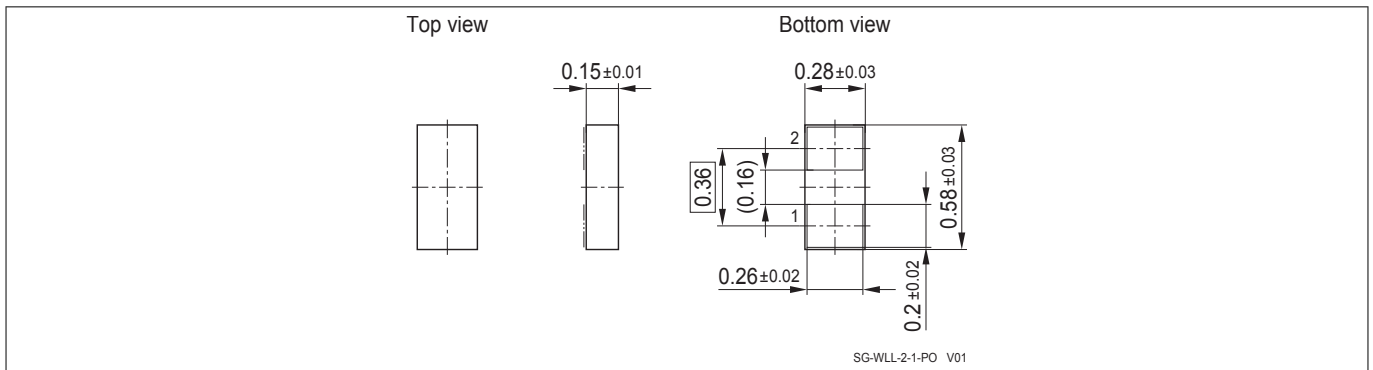

Figure 13 WLL-2-1 package outline

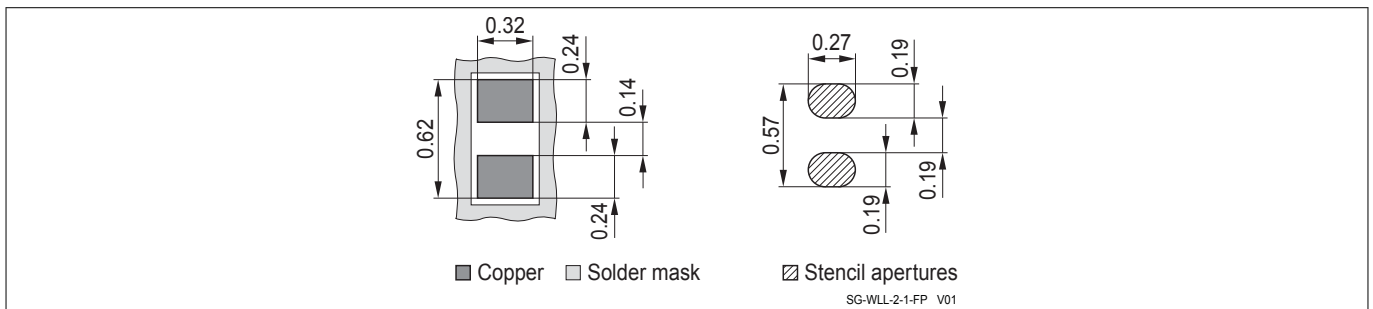

Figure 14 WLL-2-1 footprint (recommendation for printed circuit board assembly see [2])

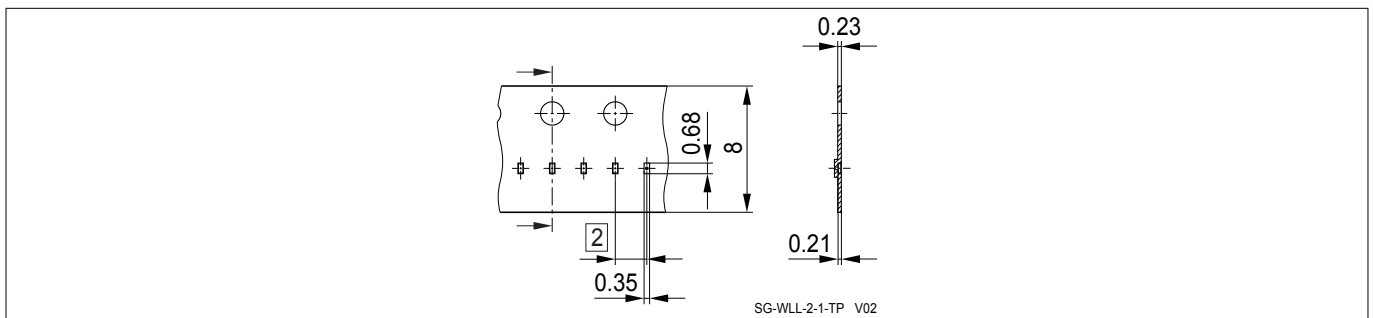

Figure 15 WLL-2-1 packing

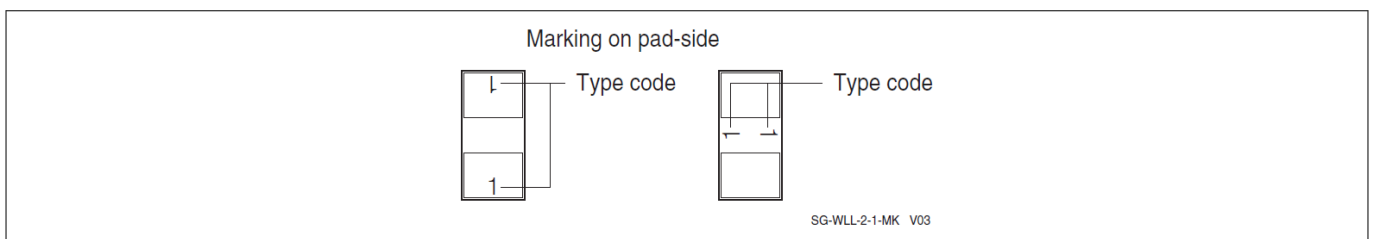

Figure 16 WLL-2-1 marking example (see Device information)

References

5 References

- [1] Infineon AG - **Application note AN210**: Effective ESD protection design at system level using VF-TLP characterization methodology
- [2] Infineon AG - **Recommendation for Printed Circuit Board Assembly of Infineon WLL Packages**
http://www.infineon.com/Packageinformation_WLL
- [3] Infineon AG - **Application note AN077**: Thermal resistance calculation
- [4] Infineon AG - **Application note AN392**: TVS diodes in ChipScalePackage reduce size and save cost

Revision history

Revision history: Rev. 1.4, 2016-04-21

Page or Item	Subjects (major changes since previous revision)
Revision 1.5, 2017-10-17	
All	Data sheet layout changed, references updated

Trademarks

All referenced product or service names and trademarks are the property of their respective owners.

Edition 2017-10-17

**Published by
Infineon Technologies AG
81726 Munich, Germany**

**© 2017 Infineon Technologies AG
All Rights Reserved.**

**Do you have a question about any
aspect of this document?
Email: erratum@infineon.com**

**Document reference
IFX-nym1501066509051**

IMPORTANT NOTICE

The information given in this document shall in no event be regarded as a guarantee of conditions or characteristics ("Beschaffheitsgarantie").

With respect to any examples, hints or any typical values stated herein and/or any information regarding the application of the product, Infineon Technologies hereby disclaims any and all warranties and liabilities of any kind, including without limitation warranties of non-infringement of intellectual property rights of any third party.

In addition, any information given in this document is subject to customer's compliance with its obligations stated in this document and any applicable legal requirements, norms and standards concerning customer's products and any use of the product of Infineon Technologies in customer's applications.

The data contained in this document is exclusively intended for technically trained staff. It is the responsibility of customer's technical departments to evaluate the suitability of the product for the intended application and the completeness of the product information given in this document with respect to such application.

WARNINGS

Due to technical requirements products may contain dangerous substances. For information on the types in question please contact your nearest Infineon Technologies office.

Except as otherwise explicitly approved by Infineon Technologies in a written document signed by authorized representatives of Infineon Technologies, Infineon Technologies' products may not be used in any applications where a failure of the product or any consequences of the use thereof can reasonably be expected to result in personal injury