

Cable assembly

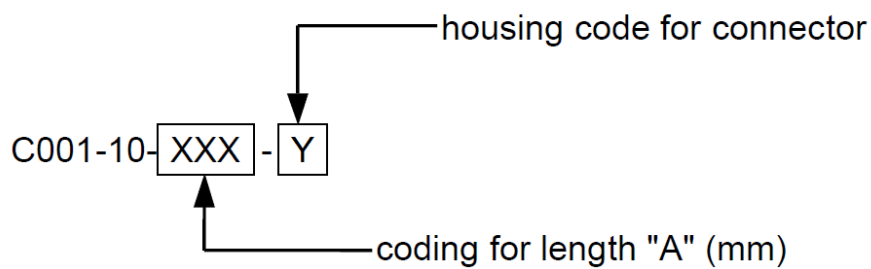
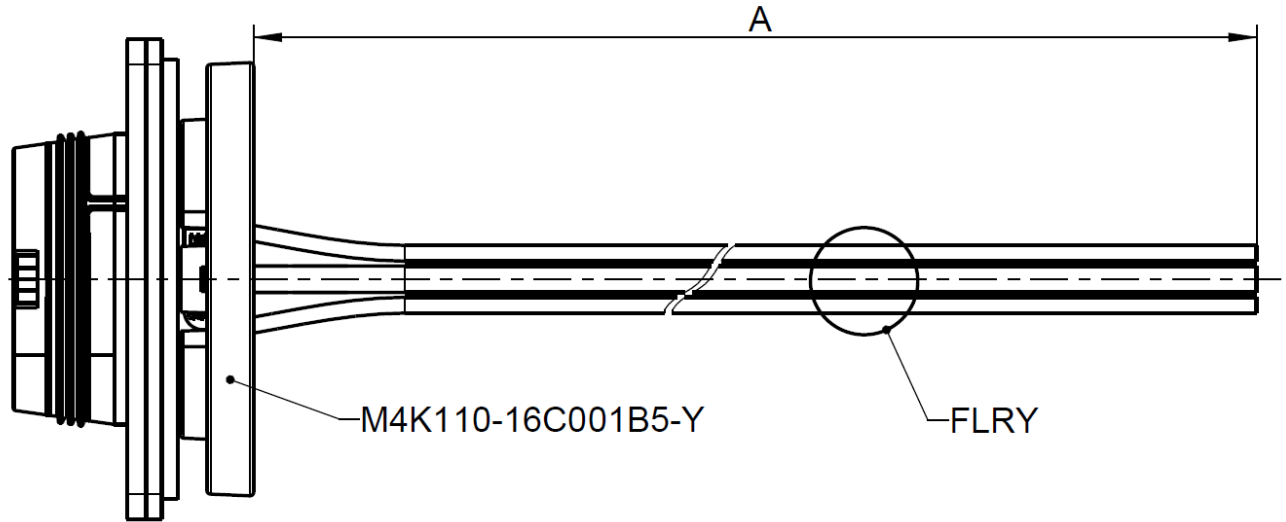

All dimensions are in mm

	cable length [mm]				
Range length "A"	50 to 100	100 to 1000	1001 to 2000	2001 to 5000	> 5000
Tolerance for "A"	± 3	± 5	± 10	± 20	± 1%

Documents

Interface	Rosenberger internal standard
Connector data sheet	M4K110-16C001B5-Y
Customer drawing	C001-10-XXX-Y_LV
Cable data sheet	FLRY 0,35-B / FLRY 1,0-B
Handling instruction	HI_003

Caution!

Magnets can impact the function of pace makers and implantable cardioverterdefibrillators (e.g. actuation of reed switch). Keep a minimum distance of 0,2m (20cm) between the magnetic connector and the implanted devices to prevent malfunction and danger to health.

Connector straight jack 4-hole flange

M4K110-16C001B5-Y

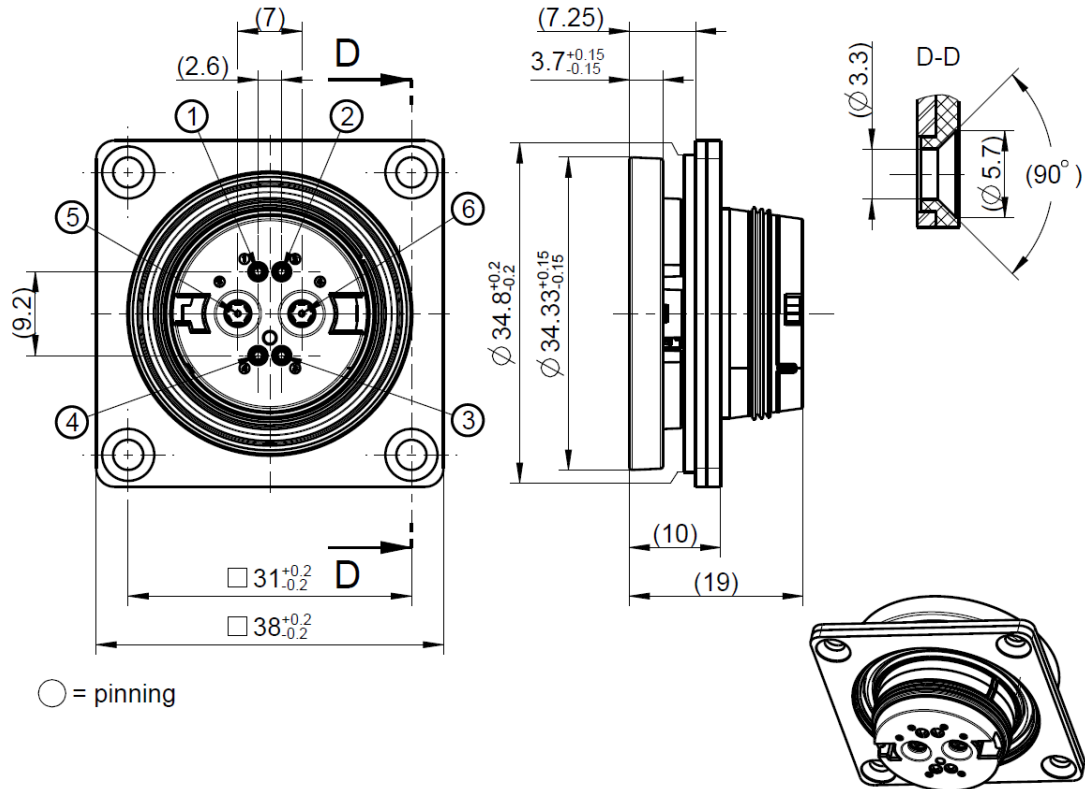

All dimensions are in mm

Pinning

Pin	colour	cable cross section
1	green	0.35 mm ²
2	blue	0.35 mm ²
3	orange	0.35 mm ²
4	brown	0.35 mm ²
5	red	1.0 mm ²
6	black	1.0 mm ²

Warning!

**Customer is responsible for implementing adequate safety measures:
 Power supply to Pins 5 & 6 must be deactivated unless they are completely plugged in.
 Power to pins 5 & 6 must only be activated upon full insertion of signal pins 1 – 4!
 Misuse may damage contact!**

Material and plating

Parts

Housing
Magnets
Sealing

Material

PBT-GF30 FR
NdFeB
Silicone

Plating / Colour

black, sim. RAL 9005
Nickel

Pins 1-4:

Contact Pin

Brass

Gold, 0,4 µm (contact)

Pins 5-6:

Power Pin
Contact spring

Brass
Beryllium copper

White bronze (e.g. Optalloy®), min. 2 µm
Silver, min. 3 µm

Electrical data

Pins 1-4:

Insulation resistance ≥ 100 MΩ
Contact resistance ≤ 40 mΩ initial
Working voltage 12 V
Max. Current 3 A per pin

Pins 5-6:

Insulation resistance ≥ 100 MΩ
Power current ≤ 10 A DC
Contact resistance ≤ 7 mΩ
Working voltage ≤ 60V DC

Mechanical data

Locking mechanism
Mating cycles
Disengagement force
Weight (connector only)

magnetic
min. 2500
min. 20N
17 g

Environmental data

Temperature range
Dust and water resistance
Glow-wire flammability test
for end products
(GWT850°C; GWT750°C)

-40°C to + 65°C
DIN-EN-60529 IP 64 / IP 67; mated
IEC 60695-2-11:2014

Mounting note

Required screws
Tightening torque

M3, countersunk head, non magnetic
25 Ncm

Cable

FLRY

Material and Dimensions

Conductor (pinning 1-4)	Bare copper strand Cu-ETP1 acc. EN13602	0.35 mm ²	AWG 22
Conductor (pinning 5-6)	Bare copper strand Cu-ETP1 acc. EN13602	1.0 mm ²	AWG 18
Outer diameter pinning 1-4	Soft-PVC	max. Ø 1.4 mm	
Outer diameter pinning 5-6	Soft-PVC	max. Ø 2.1 mm	

Mechanical data

Bending radius Single (1.0 mm ²)	2 x d
Bending radius Multiple (<10x) (1.0 mm ²)	6 x d
Bending radius Single (0.35 mm ²)	2 x d
Bending radius Multiple (<10x) (0.35 mm ²)	6 x d
Net. weight of each cable (1.0 mm ²)	ca. 11 kg/km
Net. weight of each cable (0.35 mm ²)	ca. 5 kg/km

Environmental data

Temperature resistance (3000h)	-40° C up to +105° C
--------------------------------	----------------------

Dieses Dokument ist urheberrechtlich geschützt • This document is protected by copyright • Rosenberger Hochfrequenztechnik GmbH & Co. KG

RF_35/09;14/6.2

Coding

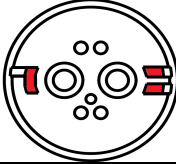
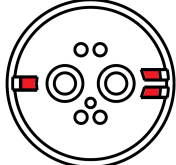
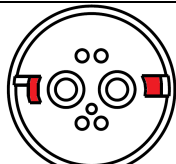
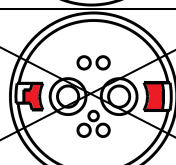
Coding	Plug	Part-Number
B		C001-10-XXX-B
C		C001-10-XXX-C
D		C001-10-XXX-D
Z		C001-10-XXX-Z

While the information has been carefully compiled to the best of our knowledge, nothing is intended as representation or warranty on our part and no statement herein shall be construed as recommendation to infringe existing patents. In the effort to improve our products, we reserve the right to make changes judged to be necessary.

Draft	Date	Approved	Date	Rev.	Engineering change number	Name	Date
F. Huber	27.07.21	C. Biermann	22.09.21	100	21-1329	F. Huber	22.09.21
Rosenberger Hochfrequenztechnik GmbH & Co. KG P.O.Box 1260 D-84526 Tittmoning Germany www.rosenberger.de					Tel. : +49 8684 18-0 Email : info@rosenberger.de		Page 5 / 5