

## Programmable Controller

FP0H SERIES



### Built-in dual Ethernet ports

~ Multiple interfaces that connect with various devices ~

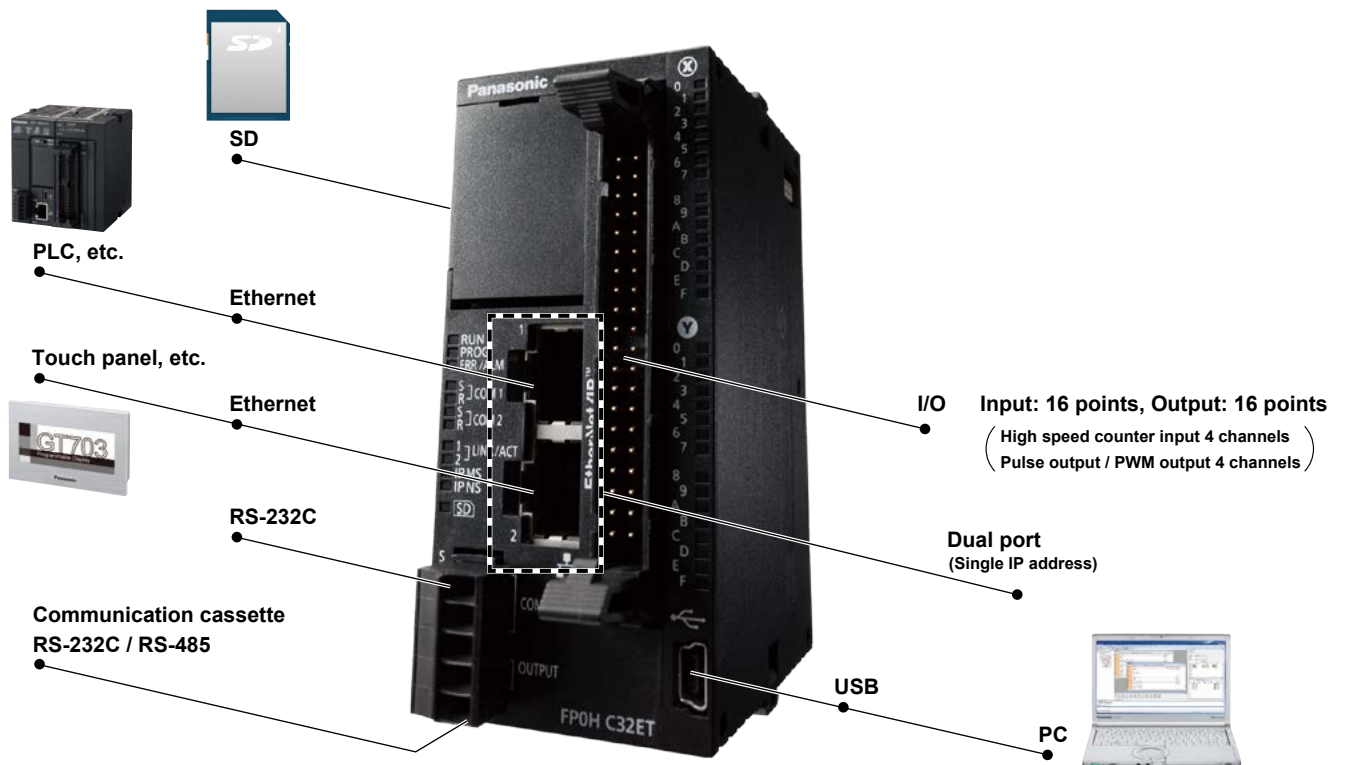

**Ultra-compact PLC**



# FP0H collects information from field level

The ultra-compact PLC “FP0H” collects information (open network supported) and achieves distributed control (no hub required with serial wiring)!

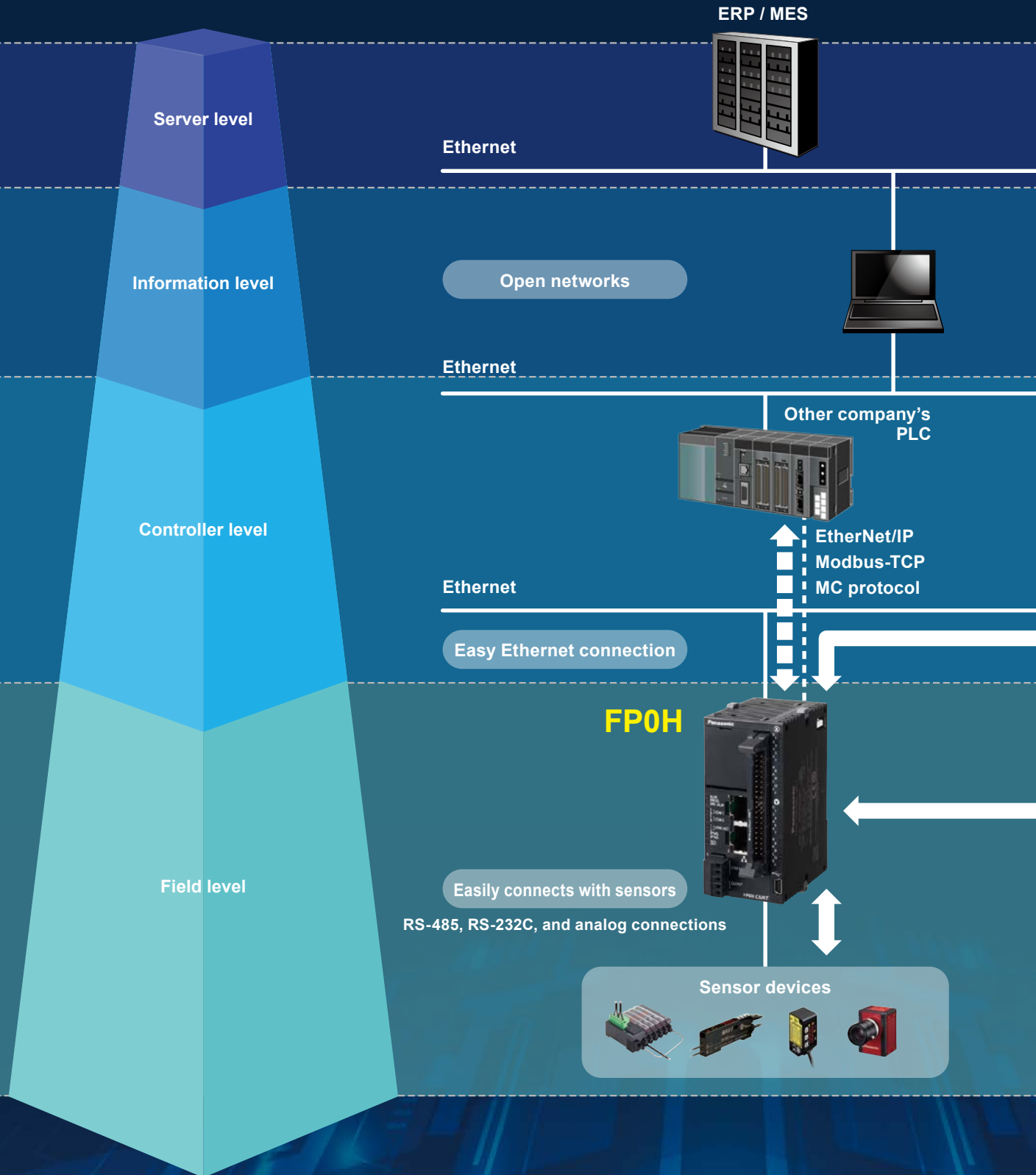

## Network hierarchy

devices.

Information visualization using FP7's Web server function



Basic performance

New functions

FP0H can transmit information to PC or server, etc.

FTP server function SSL/TLS-compatible

Allows the PC to read the logging data in the SD memory card and to write setting values and other parameters.

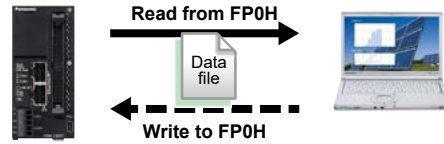

FTP client function SSL/TLS-compatible

The FP0H can generate and write data files to an FTP server on a PC as well as read data files from the FTP server.

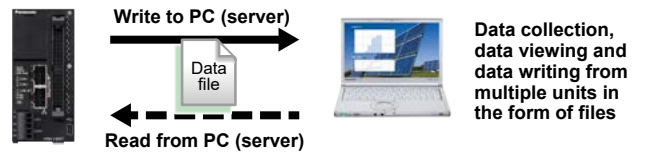

Transfer electric power data from factories and offices to an FTP server on a regular basis.

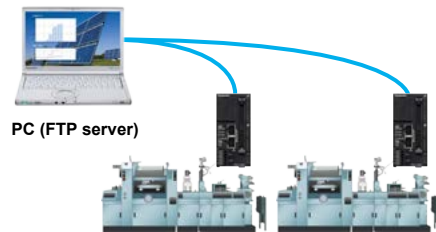

Users can access the accumulating production information in the server at any time.

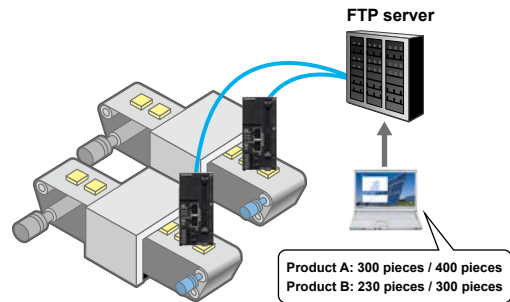

# Basic performance

## Significantly improved basic performance in an ultra-compact body!

- 8 x faster than conventional models!
**High-speed operation processing**  
 Basic instruction: 10 ns to (up to 10 k steps)
- 2 x larger than conventional models!
**High capacity Max. 64 k steps**  
 Program capacity: 64 k / 40 k / 32 k / 24 k Step variable
- Data capacity: 12 k / 24 k / 32 k / 64 k Step variable**

To improve productivity in an advanced small device!

Food processing machine   Packaging equipment   Inspection equipment

- ⦿ Faster      ▶ Reduce production costs
- ⦿ Higher capacity   ▶ Support multiple types

I/O:                    16 input points, 16 output points, Transistor output (NPN / PNP)  
 Built-in I/F:        Ethernet × 2 ports, RS-232C × 1 channel, USB × 1 channel  
 Expansion I/F: **FP0H** expansion bus × 1, **FP0R** expansion bus × 1  
                           Cassette slot × 1 (RS-232C, RS-232C × 2, RS-485, RS-232C and RS-485)  
 Tool:                 **FPWIN GR7 / FPWIN Pro7**

### Up to 384 I/O points FP0H / FPΣ / FP0R units can be added.

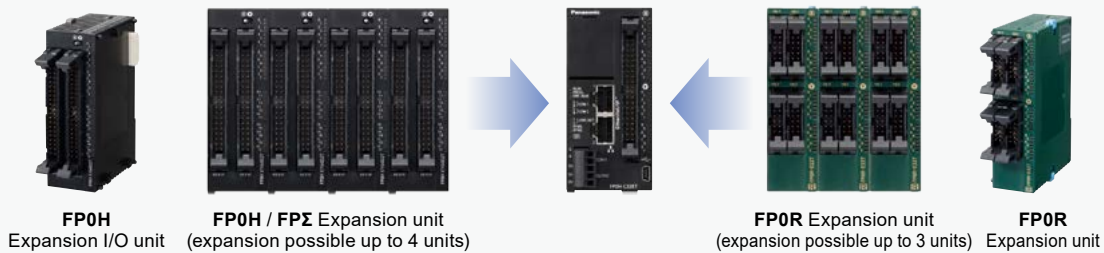

### Can select required functions to control various devices!

#### Built-in 4-axis pulse outputs

Built-in 4-axis pulse output, so simultaneous control of 2-axis linear interpolation is possible for two sets. For example, two X-Y tables can be controlled.

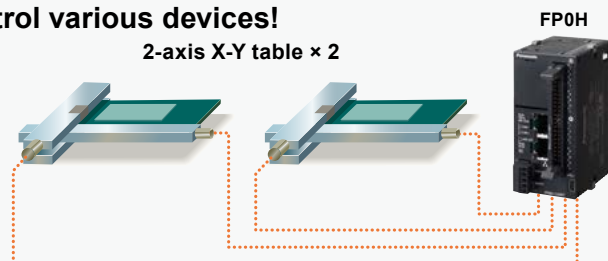

#### High-speed counter input and pulse output

Ladder programs can be combined to create an application for counting pulse signals from the encoder through the high speed counter input and adjusting the pulse output frequency based on the count to synchronize the slave axis speed with the master axis speed.

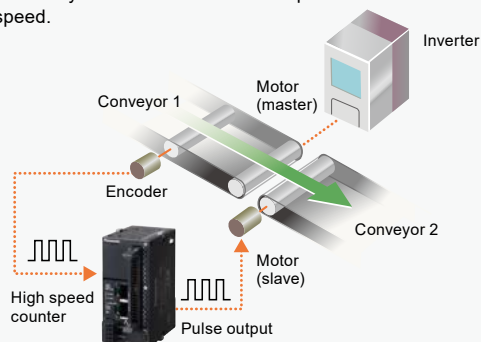

In the upper figure, the speed of conveyor 1, which is inverter controlled, is measured based on the encoder pulse count, and pulses are output (for jog operation) to the motor (slave) according to the measured speed in order to synchronize the speed of conveyor 2.

#### Built-in multipoint PWM outputs (4 channels)

The pulse output port of **FP0H** can also serve as a PWM output port. One of the application examples is an analog voltage output, which can be used for inverter speed control.

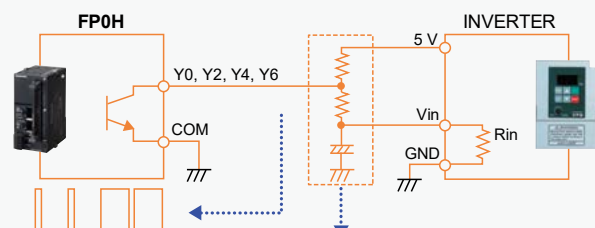

The speed can be controlled by changing the ON width of the PWM output.

The unit can also serve as an analog voltage output when a smoothing capacitor is inserted in the circuit.

## Connection to various devices

- **EtherNet/IP, Modbus-TCP and MC protocol compatibility\***
- **Easy connection with all kinds of robots and PLCs\***
- **Cassette system reduces unit cost and installation space**

\*Only for Ethernet type

### EtherNet/IP compatibility

An Ethernet type control unit supports EtherNet/IP. Easy connection with all kinds of robots and PLCs enables control and communication.

Note: EtherNet/IP is a trademark of ODVA, Inc.

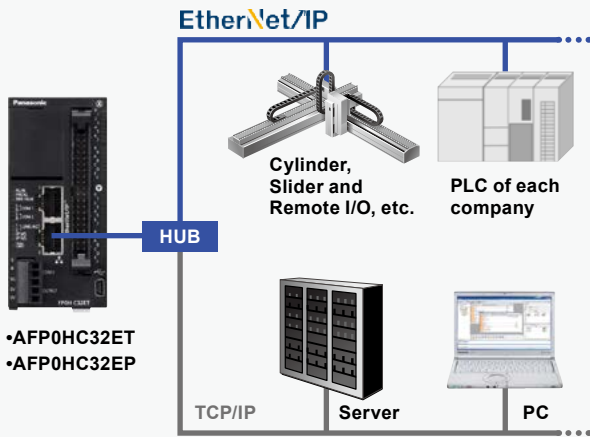

•AFP0HC32ET  
•AFP0HC32EP

### Cassette system reduces unit cost and installation space

With ease and at low cost, extend the serial communication functionality of control unit.

#### Communication cassettes

- RS-232C
- RS-232C × 2
- RS-485
- RS-232C and RS-485

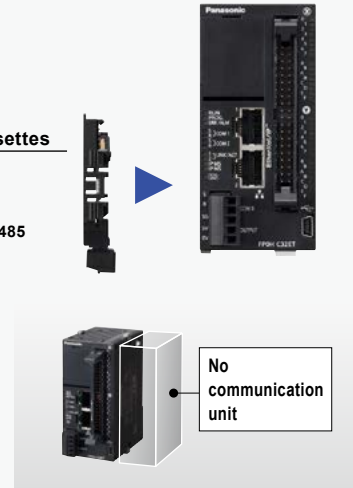

## Logs collected information

- **An SD memory card slot and a logging trace function are provided.\***
- **A project copy function can copy ladder data without a PC.\***
- **Variable data capacity handles capacity shortage.**
- **Program capacity: Max. 64 k steps\***

\* Only for Ethernet type

### Easy multiple concurrent logging

Logging set up is done via the configuration screen. Moreover, it is possible to keep up to 4 files concurrently active.

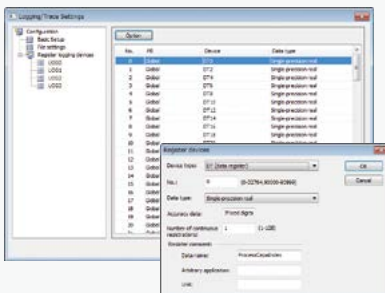

•Various triggers:  
periodic, cycle,  
bit, startup, etc.

### Use program and data register sharing to resolve data space shortage.

No need repurchase expensive upgrade models.

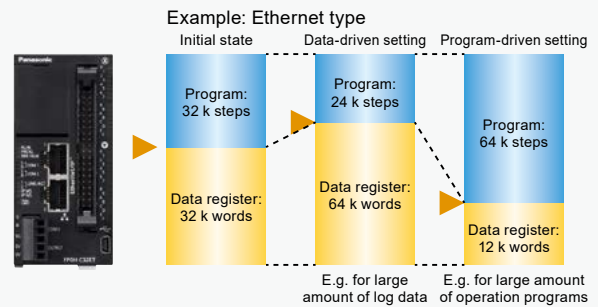

Reference value: for Ethernet type

	64 k steps	40 k steps	32 k steps	24 k steps
Program	64 k steps	40 k steps	32 k steps	24 k steps
Data register	12 k words	24 k words	32 k words	64 k words

### Can update programs with an SD memory card

Can save programs in and read them from an SD memory card. Programs can be updated easily via an SD memory card.



# Motor control

■ The control unit controls four axes with pulse output **Control unit**  
(up to 100 kHz per axis).

You can achieve position control easily only by starting a positioning action pattern configured with a dedicated setting tool.

## Positioning control configuration

The positioning table (Note 1) and parameters for each axis (Note 2) are set.

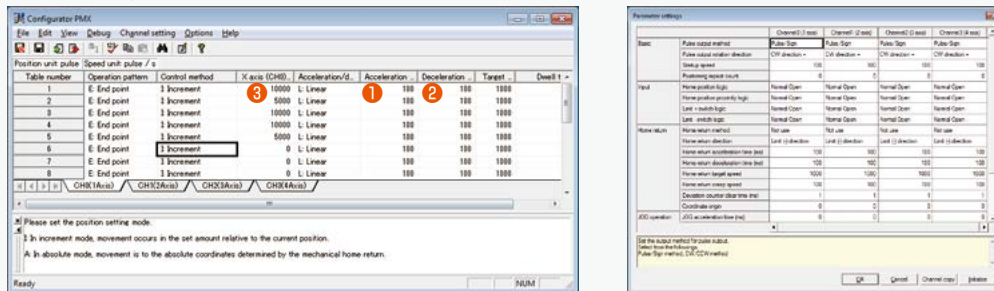

- Notes: 1) The positioning table separately shows movement amount, target speed, acceleration and deceleration time, operation mode, and other information for positing control operations.  
2) For each axis parameters are shown for limit input logic, deceleration time to stop, and operation conditions for JOG operation and return to point, etc.

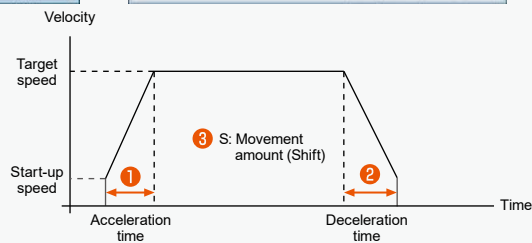

■ The positioning unit (fast start-up in 5 μs) **Expansion unit**  
can support ultra-fast linear servos.

Pulse output of up to 4 Mpps and fast start-up in 5 μs can control linear servos.

Ideal for applications that repeat short-stroke actions quickly, such as palletizing of electronics parts

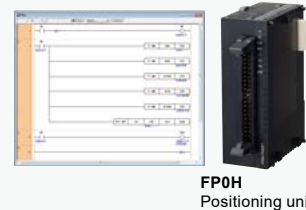

A built-in high speed counter can detect abnormalities.

Counting feedback pulses from encoders during positioning can detect accidents such as the abnormalities in the drive system.



FP0H Positioning unit

- Counts feedback pulses from the encoder to detect abnormalities.

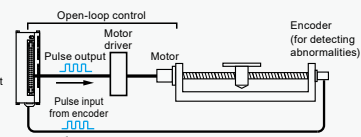

Jog positioning supports fixed feed

Fast start-up and repetitive control can support fixed-feed processing.

■ Capable of controlling a device which requires **FP0H Positioning RTEX units**  
multiple-axis synchronous control (up to eight axes)

Support of network servo drivers MINAS A6N. Significantly reduces the man-hours in wiring.  
A maximum of 16 axes. Up to two 8-axis units can be installed.

\*Synchronous control

4-axis type: Up to six axes including virtual axes (virtual axis: 2 axes)

8-axis type: Up to eight axes including virtual axes (virtual axis: 2 axes)

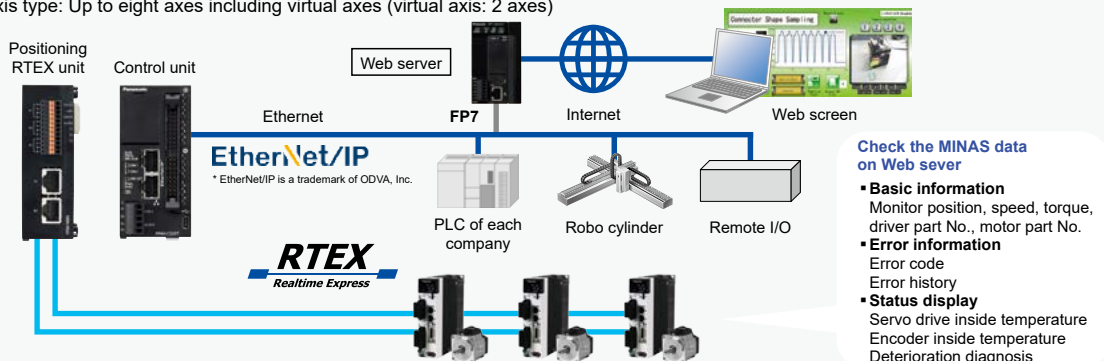

## Distributed control

- Distributed devices result in a flexible line, reducing man-hours.

### Before

Centralized control by a high performance large PLC

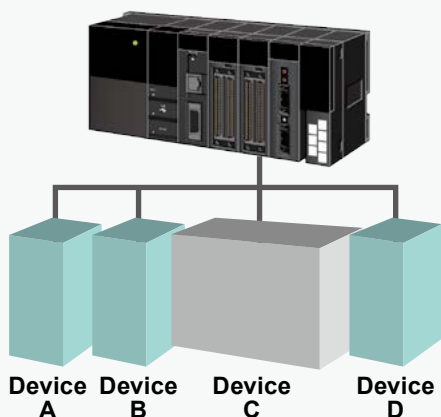

- Control of multiple devices leads to a complicated system design
- When a failure occurs, all the devices are stopped.
- System modification requires more man-hours.
- High risk at start-up and when an error occurs

### After

Distributed control where FP0H controls each device.

Data between each controller is shared over Ethernet

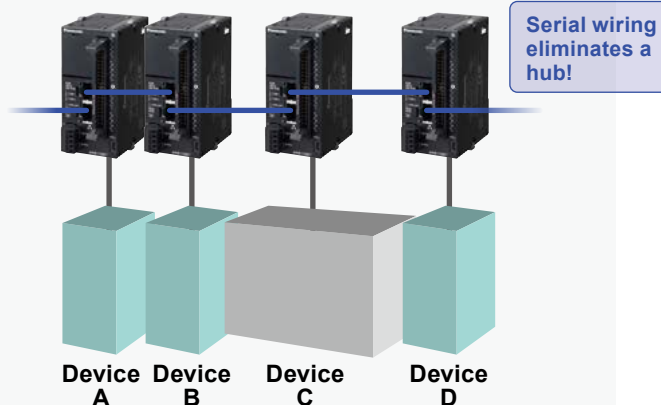

- Distributed control reduces the load on a control unit.
- Recovery of only failed devices reduces man-hours.
- System modification is available per device, which reduces man-hours.
- Lower risk at start-up and when an error occurs

## Compatibility

- Ultra-compact size inherited from FPΣ

Ultra-compact size of 90 mm 3.543 in in height contributes to the reduction in size of a device.



**FPΣ Control unit**  
(W 30 × H 90 × D 60 mm)  
W 1.181 × H 3.543 × D 2.362 in)



**FP0H Control unit (Without Ethernet type)**  
(W 30.4 × H 90 × D 60 mm)  
W 1.197 × H 3.543 × D 2.362 in)

- Ladder programs for FPΣ can be converted for FP0H.

Ladder programs for FPΣ created in Control FPCWIN GR/GR7 can be converted for FP0H. Creating new ladder programs are not required when replacing FPΣ with FP0H.

Note: When an unsupported instruction (F176 SPCH: arc interpolation) is used, convert it before model switching.

# FP0H series Lineup

## Control units



With Ethernet  
NPN type  
**AFP0HC32ET**



With Ethernet  
PNP type  
**AFP0HC32EP**



Without Ethernet  
NPN type  
**AFP0HC32T**



Without Ethernet  
PNP type  
**AFP0HC32P**

## Expansion I/O units



32 points input DC  
Transistor output  
(sink) 32 points  
**AFP0HXY64D2T**



32 points input DC  
Transistor output  
(source) 32 points  
**AFP0HXY64D2P**

## Communication cassettes



RS-232C, 1 channel  
**AFP0HCCS1**



RS-232C, 2 channels  
**AFP0HCCS2**



RS-485, 1 channel  
**AFP0HCCM1**



RS-232C, 1 channel  
RS-485, 1 channel  
**AFP0HCCS1M1**

## Positioning units



Transistor output  
1 axis  
**AFP0HPG01T**



Line driver output  
1 axis  
**AFP0HPG01L**



Transistor output  
2 axes  
**AFP0HPG02T**



Line driver output  
2 axes  
**AFP0HPG02L**

## Positioning RTEX unit



4 axes  
**AFP0HM4N**



8 axes  
**AFP0HM8N**

# Expansion units (Common to FPΣ)

## Positioning units RTEX



Orders to end on  
September 29, 2023  
2 axes  
**FPG-PN2AN**  
(AFPG43610)



Orders to end on  
September 29, 2023  
4 axes  
**FPG-PN4AN**  
(AFPG43620)



Orders to end on  
September 29, 2023  
8 axes  
**FPG-PN8AN**  
(AFPG43630)



# Expansion units (Common to FP0R)

## Input and output units

Input units



MIL connector  
Input 8 points DC  
**AFP0RE8X**



MIL connector  
Input 16 points DC  
**AFP0RE16X**

Output units



MIL connector  
Transistor output (sink) 8 points  
**AFP0RE8YT**



MIL connector  
Transistor output (source) 8 points  
**AFP0RE8YP**



Terminal block  
Relay output 8 points  
**AFP0RE8YRS**



MIL connector  
Transistor output (sink) 16 points  
**AFP0RE16YT**



MIL connector  
Transistor output (source) 16 points  
**AFP0RE16YP**

Input and output units



Terminal block  
Input 4 points DC  
Relay output 4 points  
**AFP0RE8RS**



Terminal block  
Input 8 points DC  
Relay output 8 points  
**AFP0RE16RS**



Connector  
Input 4 points DC  
Relay output 4 points  
**AFP0RE8RM**



Connector  
Input 8 points DC  
Relay output 8 points  
**AFP0RE16RM**



MIL connector  
Input 8 points DC  
Transistor output (sink) 8 points  
**AFP0RE16T**



MIL connector  
Input 8 points DC  
Transistor output (source) 8 points  
**AFP0RE16P**



MIL connector  
Input 16 points DC  
Transistor output (sink) 16 points  
**AFP0RE32T**



MIL connector  
Input 16 points DC  
Transistor output (source) 16 points  
**AFP0RE32P**

## Analog input and output units

Input units  
Output units



Input 4 channels  
**AFP0RAD4**



Input 8 channels  
**AFP0RAD8**



Output 4 channels  
**AFP0RDA4**

Input and output units



Input 2 channels  
Output 1 channel  
**AFP0RA21**



Input 4 channels  
Output 2 channels  
**AFP0RA42**

## Thermocouple units



4 channels  
**AFP0420**  
(FP0-TC4)



8 channels  
**AFP0421**  
(FP0-TC8)

## Link and communication unit

CC-Link slave unit



**AFP07943**  
(FP0-CCLS)

# Control units

Significantly improved basic performance in an ultra-compact body!



With Ethernet NPN type **AFP0HC32ET**      With Ethernet PNP type **AFP0HC32EP**  
 Without Ethernet NPN type **AFP0HC32T**      Without Ethernet PNP type **AFP0HC32P**

## Control specifications

Item	Type	Without Ethernet		With Ethernet		
		NPN type	PNP type	NPN type	PNP type	
Part No.		<b>AFP0HC32T</b>	<b>AFP0HC32P</b>	<b>AFP0HC32ET</b>	<b>AFP0HC32EP</b>	
Number of controllable I/O points		32 points (Input: 16, Output: 16). When expanded: Max. 384 points				
Programming method / Control method		Relay symbol / Cyclic operation				
Program memory		Built-in flash ROM (no backup battery required)				
Number of instructions	Basic instructions	120 types approx.				
	High-level instructions	240 types approx.		270 types approx.		
Program capacity		24 k / 32 k steps		24 k / 32 k / 40 k / 64 k steps		
		Can be selected at system register No. 0 When the program capacity is changed, the number of words that can be used in the data register (DT) is also changed.				
		Program capacity	DT Number of word			
		24 k steps 32 k steps (initial value) 40 k steps 64 k steps	65,533 words 32,765 words (initial value) 24,573 words 12,285 words			
Operation speed		Basic instruction (NOT /): 10 ns/step approx. (Up to 10 k steps), 0.18 µs/step approx. (10 k steps and later)				
		Basic instruction (ST): 40 ns/step approx. (Up to 10 k steps), 0.65 µs/step approx. (10 k steps and later)				
		High-level instruction (FOMV): 0.14 µs/step approx. (Up to 10 k steps), 1.2 µs/step approx. (10 k steps and later)				
Base scan time		Control unit: 40 µs or less approx. and <b>FP0 / FP0R</b> expansion unit refresh time (Note 1)		Control unit: 100 µs or less approx. and <b>FP0 / FP0R</b> expansion unit refresh time (Note 1)		
	I/O refresh and base time					
Operation memory	Relay	External input (X) (Note 2, 3)	1,760 points (X0 to X109F)			
		External output (Y) (Note 2, 3)	1,760 points (Y0 to Y109F)			
		Internal relay (R) (Note 3)	4,096 points (R0 to R255F) or 8,192 points (R0 to R511F) (Note 4)		8,192 points (R0 to R511F)	
	Memory area	Special internal relay (R)	800 points (R9000 to R951F)			
		Timer / Counter (T / C) (Note 5)	1,024 points (initial setting, timer: 1,008 points, counter: 16 points)			
		Link relay (L)	2,048 points (L0 to L127F)			
		Data register (DT) (Note 6)	32,765 words or 65,533 words		12,285 words or 24,573 words or 32,765 words or 65,533 words	
Special data register (DT) (Note 3)	1,000 words (DT90000 to DT90999)					
Link data register (LD)	256 words (LD0 to LD255)					
Index register (I)	14 words (I0 to I14)					
Differential points		Points for the program capacity				
Number of master control relay (MCR)		256 points				
Number of labels (JP and LOOP)		256 points				
Number of step ladder		1,000 stages				
Number of subroutines		500 subroutines				
Number of interrupt program		9 programs				
		•Input: 8 programs (INT0 to INT7) •Periodic: 1 program (INT24)				
Sampling trace (Note 7)		Available (Sampling by commands / Sampling at regular time intervals) (For one sampling: 16 bits + 3 words), 1,000 samples				
Comment storage		I/O comments, remarks and block comments can be stored. (no backup battery required, 1 M byte)				
PLC link function (Serial communication)		Max. 16 units, link relays: 1,024 points, link registers: 128 words. (Data transfer and remote programming are not supported)				

Item	Type	Without Ethernet		With Ethernet	
		NPN type	PNP type	NPN type	PNP type
Part No.		<b>AFP0HC32T</b>	<b>AFP0HC32P</b>	<b>AFP0HC32ET</b>	<b>AFP0HC32EP</b>
Constant scan		Available (0 to 600 ms)			
Password		Available (32 digits)			
Program upload protection		Available			
Program protect function		Available			
Self-diagnostic function		Watchdog timer, program syntax check, etc.			
Program edition during RUN		Available			
SD memory card function		—		SD memory card project copy, Logging trace function (Note 7), SD memory card access (instruction)	
Memory transfer		Available [Built-in memory (ROM ⇄ RAM)]			
High speed counter (Note 8)	Main unit input	Single-phase 4 channels (Max. 100 kHz each input) or 2-phase 2 channels (Max. 50 kHz each input)			
Pulse output (Note 8)	Main unit output	4 channels (Max. 100 kHz each axis)			
PWM output (Note 8)	Main unit output	4 channels (1 Hz to 70 kHz: 1,000 resolution / 70.001 kHz to 100 kHz: 100 resolution)			
Pulse catch input	Interrupt input	Total 8 points (with high speed counter)			
Periodical interrupt		0.1 ms to 30 sec.			
Potentiometer (Volume) input (Note 3)		2 channels (0 to 4000)		Not available	
Clock / calendar (Note 9, 10)		Year (last two digits), month, day, hour (24-hour display), minute, second and day of week			
Memory backup (Note 11)	Backup by instruction P13	Data register: all area			
	Auto-backup at power failure	Counter: 16 points Internal relay: 128 points Data register: 315 words			
Battery backup (only when a battery is installed)		Hold areas or non-hold areas can be specified by setting the system registers No.6 to No. 13. (It is also possible to make the setting for hold all points.)			
Battery life		5 years or more under a production condition (operates for 8 hours per day)			

Notes: 1) Refresh times for <b>FP0 / FP0R</b> expansion units	8 points unit	Number of units × 0.8 ms
	16 points unit	Number of units × 1.0 ms
	32 points unit	Number of units × 1.3 ms
	64 points unit	Number of units × 1.9 ms

- The number of points that can be used depends on the combination of hardware.
- Some specifications are compatible with **FPΣ**.
- System register No. 1 (internal relay capacity) can be configured to select "0: 4,096 points / 1: 8,192 points".
- An auxiliary timer instruction (F137) can be used to add the number of points.
- System register No. 0 (program capacity) can be configured to select the capacity of the data register (DT).
- Logging trace and sampling trace cannot be used at the same time.
- The specifications are based on the rated input voltage of 24 V DC at +25 °C +77 °F.  
The maximum operation frequency may be lower depending on the applied voltage, ambient temperature, and conditions of use.  
The maximum operation frequency varies depending on how the unit is used.
- Accuracy of the clock / calendar (within ± 90 seconds per month at +25 °C +77 °F).  
If an error of the clock / calendar becomes a problem in the system, set an accurate time periodically.
- If the battery is not attached, calendar information is cleared when the power is turned off. It will be necessary to set the date when the power is turned on.
- Data can be rewritten up to 10,000 times. Hold / non-hold areas can be specified in the system registers.

## General specifications

Item	Type	Without Ethernet		With Ethernet	
		NPN type	PNP type	NPN type	PNP type
CE marking directive compliance	Part No.	AFP0HC32T	AFP0HC32P	AFP0HC32ET	AFP0HC32EP
Rated voltage		EMC Directive, RoHS Directive			
Operating voltage range		24 V DC			
Consumption current		140 mA or less		170 mA or less	
Allowed momentary power off time		4 ms (at 20.4 V DC), 10 ms (24 V DC or higher)			
Ambient temperature		0 to +55 °C +32 to +131 °F, At storage: -40 to +70 °C -40 to +158 °F			
Ambient humidity		10 to 95 % RH (at +25 °C +77 °F, no dew condensation allowed), At storage: 10 to 95 % RH (at +25 °C +77 °F, no dew condensation allowed)			
Breakdown voltage (Detection current: 5 mA)		500 V AC for 1 minute Input and output terminals ⇄ power and functional ground terminals Input terminals ⇄ Output terminals			
Insulation resistance (Test voltage: 500 V DC)		100 MΩ or more Input and output terminals ⇄ power and functional ground terminals Input terminals ⇄ Output terminals			
Vibration resistance		5 to 8.4 Hz, single amplitude of 3.5 mm, 8.4 to 150 Hz, constant acceleration of 9.8 m/s <sup>2</sup> , for 10 times each in X, Y, and Z directions (1 octave/min.) (JIS B 3502, IEC 61131-2)			
Shock resistance		147 m/s <sup>2</sup> , 4 times each in X, Y, and Z directions (JIS B 3502, IEC 61131-2)			
Noise immunity		1,000 V (p-p) with pulse widths 50 ns and 1 μs (using a noise simulator) (Power supply terminal)			
Operating condition		Free from corrosive gasses and excessive dust			
Overvoltage category		Category II			
Degree of pollution		Pollution level 2			
Net weight		110 g approx. each		130 g approx. each	

## COM0 port communication specifications

Item	Specifications	
Interface	RS-232C, three-wire system, 1 channel (Not insulated)	
Transmission distance	15 m <b>49.213 ft</b>	
Communication configuration	1 : 1 communication	
Communication method	Half-duplex system	
Synchronous method	Start-stop synchronization system	
Transmission cable	Multi-conductor shielded wire	
Communication speed (Specified at the system registers)	1,200 (Note 3), 2,400 (Note 3), 4,800, 9,600, 19,200, 38,400, 57,600, 115,200, 230,400 bits/sec.	
Transmission format	Data length	7 bits / 8 bits
	Parity	none / odd / even
	Stop bit	1 bit / 2 bits
	Start code	with STX / without STX
	End code	CR / CR + LF / none / ETX / Time (0 to 100.00 ms)
Data transmission order	Transmit from bit 0 in character units	
Communication mode	MEWTOCOL-COM (Master / Slave) (Computer link) General-purpose communication PLC link MODBUS RTU (Master / Slave)	

Notes: 1) The start and end codes can be used only for general-purpose serial communications.  
2) The unit No. (station number) can be selected at system register No. 410.  
3) System register no. 415 cannot be used to set the baud rate to 1,200 bps. To set the baud rate to 1,200 bps, use the SYS1 instruction. If the baud rate of any of the COM ports is 2,400 bps or lower, F-ROM access will slow down. Example) F12(ICRD) instruction, P13(ICWT) instruction, etc.

## LAN port communication specifications (for only Ethernet type)

Item	Specifications
Communication interface	Ethernet 100BASE-TX / 10BASE-T
Baud rate	100 Mbps, 10 Mbps auto negotiation function
Total cable length	100 m <b>328.084 ft</b> (500 m <b>1640.420 ft</b> when a repeater is used)
Number of simultaneous connections	Max. 10 (system connection: 1, user connection: 9)
Communication method	Full duplex / Half-duplex system
Communication protocol (Communication layer)	TCP / IP, UDP
DNS	Supports name servers
DHCP	Automatic IP address acquisition
FTP server / client	Server function: File transmission, No. of users: 1 Client function: Data and file transmission
SNTP	Time adjustment function
General-purpose communication	4 kB / 1 connection (user connection: 1 to 9) (Note 2)
Dedicated communication	EtherNet/IP MEWTOCOL-COM (Master / Slave) (Computer link) MODBUS-TCP (Master / Slave) MEWTOCOL-DAT (Master / Slave) General-purpose communication MC protocol (Note 1) (Master / Slave)

Notes: 1) MC protocol is a short form denoting MELSEC communication protocol; MELSEC is a registered trademark of Mitsubishi Electric Corporation.  
QnA compatible 3E frame, only binary (bulk writing and bulk reading) use is available.  
2) General-purpose communications can be up to 4 kB (reception) and up to 2 kB (transmission) per connection.

## USB port specifications

Item	Specifications
Standard	USB2.0 Full speed (USB mini B type)
Communication function	Computer link (slave)

## Dedicated power supply output port specifications for GT series programmable display

Output terminal	Connecting programmable display model
5 V DC	For 5 V DC type <b>GT02</b> series Programmable Display

## Input specifications

Item	Specifications	
Rated input voltage	24 V DC	
Operating voltage range	21.6 to 26.4 V DC	
Rated input current	High-speed part (X0 to X7) : 8 mA approx. Low-speed part (X8 to XF) : 3.5 mA approx.	
Input points per common	16 points/common (Either the positive or negative of the input power supply can be connected to the common terminal.)	
Min. ON voltage / Min. ON current	High-speed part (X0 to X7) : 19.2 V DC / 6 mA Low-speed part (X8 to XF) : 19.2 V DC / 3 mA	
Max. OFF voltage / Max. OFF current	2.4 V DC / 1 mA	
Input impedance	High-speed part (X0 to X7) : 3 kΩ approx. Low-speed part (X8 to XF) : 6.8 kΩ approx.	
Response time (Note)	OFF → ON	<High-speed part (X0 to X7)> 135 μs or less: normal input 5 μs or less: high speed counter, pulse catch, interrupt input settings <Low-speed part (X8 to XF)> 1 ms or less: normal input only
	ON → OFF	Same as above
Operating mode indicator	LED display	

Note: The input time constant (0.1 to 256 ms) can be specified.

## Output specifications

Item	Type	Without Ethernet		With Ethernet	
		AFP0HC32T	AFP0HC32P	AFP0HC32ET	AFP0HC32EP
Output type		Nch open drain		Pch open drain	
Rated load voltage		5 to 24 V DC		24 V DC	
Operating load voltage range		4.75 to 26.4 V DC		21.6 to 26.4 V DC	
Rated load current		0.3 A (For Y0, Y1, Y3, Y4, Y8, Y9, YB, YC), 0.1 A (For Y2, Y5, Y6, Y7, YA, YD, YE, YF)		0.3 A (For Y0 to YF)	
Max. surge current		High-speed part (For Y0, Y1, Y3, Y4, Y8, Y9, YB, YC) : 1.0 A, Low-speed part (For Y2, Y5, Y6, Y7, YA, YD, YE, YF) : 0.5 A			
OFF state leakage current		1 μA or less		2 μA or less	
ON state voltage drop		0.5 V DC or less			
Overcurrent protection		Provided (automatically protected for each 8 points)			
Output points per common		16 points/common (Y0 to YF / 1 common)			
Response time	OFF → ON	High-speed part (For Y0, Y1, Y3, Y4, Y8, Y9, YB, YC) : 2 μs or less, Low-speed part (For Y2, Y5, Y6, Y7, YA, YD, YE, YF) : 1 ms or less			
	ON → OFF	High-speed part (For Y0, Y1, Y3, Y4, Y8, Y9, YB, YC) : 5 μs or less, Low-speed part (For Y2, Y5, Y6, Y7, YA, YD, YE, YF) : 1 ms or less			
Surge absorber		Zener diode			
Operating mode indicator		LED display			

### Limitations on simultaneous ON points

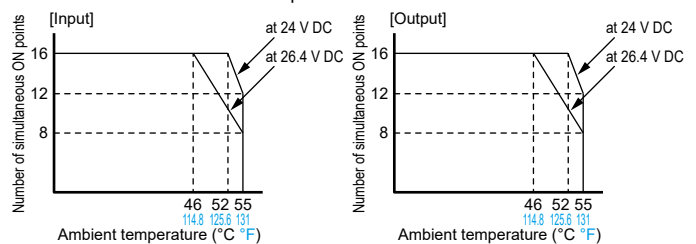

## Current consumption

Type of unit	Control unit current consumption (at 24 V DC)	Additional current (at 24 V DC)	Expansion unit current consumption (at 24 V DC)
Control unit alone	AFP0HC32T	—	—
	AFP0HC32P		
	AFP0HC32ET		
Extension unit attached	AFP0HC32EP	35 mA or less	—
	AFP0HXY64D2T		
	AFP0HXY64D2P		
	AFP0HPG01T		
	AFP0HPG01L		
Extension cassette attached	AFP0HPG02T	70 mA or less	35 mA or less
	AFP0HPG02L		
	AFP0HCCS1		
	AFP0HCCS2		
Expansion unit attached	AFP0HCCM1	30 mA or less	—
	AFP0HCCS1M1		

Note: For details about the current consumption of **FPΣ** expansion units and **FP0 / FPOR** expansion units, refer to relevant specifications and manuals.

# Expansion I/O units

32 input and 32 output points



**AFP0HXY64D2T**  
Input 32 points DC  
Transistor output (sink)  
32 points  
**AFP0HXY64D2P**  
Input 32 points DC  
Transistor output (source)  
32 points

## General specifications

Item	Specifications
Ambient temperature	0 to +55 °C <b>+32 to +131 °F</b> , At storage: -20 to +70 °C - <b>4 to +158 °F</b>
Ambient humidity	30 to 85 % RH (at +25 °C <b>+77 °F</b> , no dew condensation allowed), At storage: 30 to 85 % RH (at +25 °C <b>+77 °F</b> , no dew condensation allowed)
Breakdown voltage (Detection current: 5 mA)	500 V AC for 1 minute Input and output terminals ⇄ power and functional ground terminals (at control unit) Input terminals ⇄ Output terminals
Insulation resistance (Test voltage: 500 V DC)	100 MΩ or more Input and output terminals ⇄ power and functional ground terminals (at control unit) Input terminals ⇄ Output terminals
Vibration resistance	10 to 55 Hz, 1 sweep/min., double amplitude of 0.75 mm, 10 minutes each in X, Y, and Z directions
Shock resistance	98 m/s <sup>2</sup> , 4 times each in X, Y, and Z directions
Noise immunity	1,000 V (p-p) with pulse widths 50 ns and 1 μs (using a noise simulator)
Operating condition	Free from corrosive gasses and excessive dust
Net weight	100 g approx.
Control unit's additional consumption current	35 mA or less (at 24 V DC) [100 mA or less (internal 5 V DC)]

# Communication cassettes

A cassette system reduces the cost and footprint of the unit



**AFP0HCCS1** RS-232C 1ch  
**AFP0HCCS2** RS-232C 2ch  
**AFP0HCCM1** RS-485 1ch  
**AFP0HCCS1M1** RS-232C 1ch + RS-485 1ch

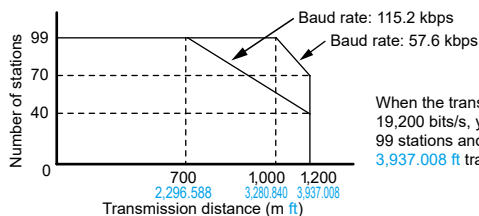

## Input specifications

Item	Specifications
Insulation method	Photocoupler
Rated input voltage	24 V DC
Operating voltage range	21.6 to 26.4 V DC
Rated input current	3.5 mA approx.
Input points per common	32 points/common (Either the positive or negative of the input power supply can be connected to the common terminal.)
Min. ON voltage / Min. ON current	19.2 V DC / 3 mA
Max. OFF voltage / Max. OFF current	2.4 V DC / 1.3 mA
Input impedance	6.8 kΩ approx.
Response time	OFF → ON ON → OFF
Operating mode indicator	LED display

## Output specifications

Item	Type Part No.	Sink type		Source type		
		<b>AFP0HXY64D2T</b>	<b>AFP0HXY64D2P</b>			
Insulation method	Photocoupler					
Output type		Open collector (NPN)	Open collector (PNP)			
Rated load voltage		5 to 24 V DC	24 V DC			
Operating load voltage range		4.75 to 26.4 V DC	21.6 to 26.4 V DC			
Rated load current		0.1 A				
Max. surge current		0.5 A				
Output points per common		32 points/common				
OFF state leakage current		100 μA or less				
ON state voltage drop		0.5 V DC or less				
Response time		OFF → ON	0.2 ms or less			
		ON → OFF	0.5 ms or less			
External power supply (for driving internal circuit)		Voltage	21.6 to 26.4 V DC			
		Current	35 mA or less	40 mA or less		
Surge absorber		Zener diode				
Operating mode indicator		LED display				
Short circuit protection		Short circuit protection, Thermal protection				

Number of simultaneous ON points

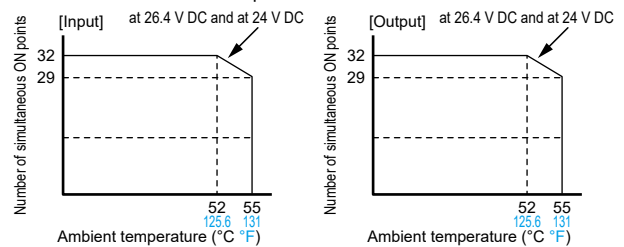

## Specifications

Refer to p.11 for the general specifications.

Item	Specifications			
	<b>AFP0HCCS1</b>	<b>AFP0HCCS2</b>	<b>AFP0HCCM1</b>	<b>AFP0HCCS1M1</b>
Interface	RS-232C 1 channel	RS-232C 2 channels	RS-485 1 channel	RS-232C 1 channel and RS-485 1 channel
Transmission distance	Max. 15 m <b>49.213 ft</b>		Max. 1,200 m <b>3,937.008 ft</b>	RS-232C Max. 15 m <b>49.213 ft</b> RS-485 Max. 1,200 m <b>3,937.008 ft</b>
Communication configuration	1 : 1 communication		1 : N communication	1 : 1 communication 1 : N communication
Communication speed	1,200 (Note 1), 2,400 (Note 1), 4,800, 9,600, 19,200, 38,400, 57,600, 115,200, 230,400 bits/sec.			
Communication method	Half-duplex system			
Synchronous method	Start-stop synchronization system			
Transmission format	Data length	7 bits / 8 bits		
	Parity	none / odd / even		
	Stop bit	1 bit / 2 bits		
	Start code	with STX / without STX		
	End code	CR / CR + LF / none / ETX / Time (0 to 100 ms)		
Data transmission order	Transmit from bit 0 in character units.			
Number of stations	—	—	Max. 99 units	Max. 99 units
Net weight	10 g approx. each			

- Notes: 1) System register no. 415 cannot be used to set the baud rate to 1,200 bps. To set the baud rate to 1,200 bps, use the SYS1 instruction. If the baud rate of any of the COM ports is 2,400 bps or lower, F-ROM access will slow down.  
Example) F12(ICRD) instruction, P13(ICWT) instruction, etc.  
2) The start and end codes can be used only for general-purpose serial communications.  
3) The unit No. (station number) can be selected at system register.  
4) Sufficient noise tolerance is provided but it is recommended that a user program be created for retransmission. (To improve the reliability of communications when a communication error occurs due to an excessive noise or when the target device cannot receive data temporarily.)  
5) When connecting a commercially available device that has an RS-485 interface, please confirm operation using the actual device. In some cases, the number of station units, transmission distance and communication speed vary depending on the connected device.  
6) The transmission distance, transmission speed, and number of stations should be within the range of the graph on the left, depending on each value.

# Positioning units

Fast start-up in 5  $\mu$ s can support ultra-fast linear servos



**AFP0HPG01T**  
Transistor output  
1 axis

**AFP0HPG01L**  
Line driver output  
1 axis

**AFP0HPG02T**  
Transistor output  
2 axes, independent

**AFP0HPG02L**  
Line driver output  
2 axes, independent

## Specifications

Refer to p.11 for the general specifications.

Part No.		<b>AFP0HPG01T</b>	<b>AFP0HPG01L</b>	<b>AFP0HPG02T</b>	<b>AFP0HPG02L</b>
Item					
Output type		Transistor	Line driver	Transistor	Line driver
Number of occupied points		Input 16 points, Output 16 points		Input 32 points, Output 32 points	
Number of axes controlled		1 axis		2 axes, independent	
Position command	Command units	Pulse unit (The program specifies whether Increment or Absolute is used.)			
	Max. pulse count	Signed 32 bits (-2,147,483,648 to +2,147,483,647 pulses)			
Speed command	Command range	1 pps to 500 kpps (can set in 1 pps.)	1 pps to 4 Mpps (can set in 1 pps.)	1 pps to 500 kpps (can set in 1 pps.)	1 pps to 4 Mpps (can set in 1 pps.)
	Acceleration / deceleration method	Linear acceleration / deceleration, S acceleration / deceleration			
Acceleration / deceleration command	S-curve type	Can select from Sin curve, Secondary curve, Cycloid curve and Third curve.			
	Acceleration / deceleration time	0 to 32,767 ms (can set in 1 ms)			
Home return	Home return speed	Speed setting possible (changes return speed and search speed)			
	Input signal	Home input, Near home input, Over limit input (+), Over limit input (-)			
	Output signal	Deviation counter clear signal			
Operation mode		E point control (Linear accelerations / decelerations, S accelerations / decelerations) P point control (Linear accelerations / decelerations, S accelerations / decelerations) Home return function (Home search) JOG operation function (Note 1) JOG positioning function Pulser input function (Note 3) • Transfer multiplication ratio ( $\times 1, \times 2, \times 5, \times 10, \times 50, \times 100, \times 500, \times 1000$ ) Real-time frequency change function Infinity output function			
Startup time		0.02 ms or 0.005 ms selectable (Note 2)			
Output interface	Output mode	1 pulse output (Pulse and Sign), 2-pulse output (CW and CCW)			
Feed back counter function (Note 3)	Countable range	Signed 32 bits (-2,147,483,648 to +2,147,483,647 pulses)			
	Input mode	Two-phase input, Direction distinction input, Individual input (transfer multiple available for each.)			
Other functions		The flag to compare the elapsed value is built in. (The timing signal outputs at the optional position during an operation.)			
External power supply	Voltage	21.6 to 26.4 V DC			
	Current consumption	20 mA		30 mA	
Net weight		75 g approx. each		80 g approx. each	

Notes: 1) When selected linear acceleration / deceleration operation, the target speed can be changed during an operation.

2) The startup time can be changed by the control code setting in the shared memory. The factory setting (default setting) is 0.02 ms. The startup time is the time from the start request to the first pulse output.

3) Pulser input function and feedback counter function use the same pulse input terminal, so the both cannot function simultaneously.

# Positioning RTEX units

Perfect fit for small devices

Capable of controlling a device which requires multiple-axis synchronous control (up to eight axes)



**AFP0HM4N**  
4 axes

**AFP0HM8N**  
8 axes

## Specifications

Refer to p.11 for the general specifications.

Type		4-axis type	8-axis type	
Item	Part No.	AFP0HM4N	AFP0HM8N	
Number of axes controlled		4 axes	8 axes	
Interpolation control		2-axis linear interpolation, 2-axis circular interpolation, 3-axis linear interpolation and 3-axis spiral interpolation		
Occupied I/O points		128 input points, 128 output points		
Automatic operation	Position control	Position specification mode Absolute (Absolute position specification), Increment (Relative position specification) pulse		
		Position specified unit µm (Min. unit of instruction selectable between 0.1 µm and 1 µm) inch (Min. unit of instruction selectable between 0.00001 inch and 0.0001 inch) degree (Min. unit of instruction selectable between 0.1 degree and 1 degree)		
		Position setting range pulse : -2,147,482,624 to 2,147,482,624 pulse µm (0.1 µm) : -214,748,262.4 to 214,748,262.4 µm µm (1 µm) : -2,147,482,624 to 2,147,482,624 µm inch (0.00001 inch) : -21,474.82624 to 21,474.82624 inch inch (0.0001 inch) : -214,748.2624 to 214,748.2624 inch degree (0.1 degree) : -214,748,262.4 to 214,748,262.4 degree degree (1 degree) : -2,147,482,624 to 2,147,482,624 degree		
		Speed reference range pulse : 1 to 2,147,482,624 pps µm : 1 to 2,147,482,624 µm/s inch : 0.001 to 2,147,482,624 inch/s degree: 0.001 to 2,147,482,624 rev/s		
		Acceleration and deceleration method Linear acceleration / deceleration, S acceleration / deceleration		
		Acceleration time 0 to 10,000 ms (Settable by 1 ms)		
		Deceleration time 0 to 10,000 ms (Settable by 1 ms)		
		No. of positioning tables Each axis: 600 points in standard area and 89 points in extended area		
		Control method		
		Independent PTP control (E-point control, C-point control), CP control (P-point control), Speed control (J-point control)		
	2-axis interpolation Linear interpolation E point, P point, C point controls, Composite speed or Long axis speed			
	Circular interpolation E point, P point, C point controls, Center point or Pass point			
	3-axis interpolation Linear interpolation E point, P point, C point controls, Composite speed or Long axis speed			
	Spiral interpolation E point, P point, C point controls, Center point or Pass point			
	Startup time Standard area: 3 ms or less, Extended area: 5 ms or less			
	Other functions			
	Dwell time 0 to 32,767 ms (Settable by 1 ms)			
	Manual operation	JOG operation	Speed reference range pulse : 1 to 2,147,482,624 pps µm : 1 to 2,147,482,624 µm/s inch : 0.001 to 2,147,482,624 inch/s degree: 0.001 to 2,147,482,624 rev/s	
			Acceleration / deceleration method Linear acceleration / deceleration, S acceleration / deceleration	
			Acceleration time 0 to 10,000 ms (Settable by 1 ms)	
Deceleration time 0 to 10,000 ms (Settable by 1 ms)				
Home return *1		Speed reference range pulse : 1 to 2,147,482,624 pps µm : 1 to 2,147,482,624 µm/s inch : 0.001 to 2,147,482,624 inch/s degree: 0.001 to 2,147,482,624 rev/s		
		Acceleration / deceleration method Linear acceleration/deceleration		
		Acceleration time 0 to 10,000 ms (Settable by 1 ms)		
		Deceleration time 0 to 10,000 ms (Settable by 1 ms)		
Return method DOG method (3 types), Limit method (2 types), Data set method, Z phase method, Stop-on-contact method (2 types)				
Pulsar operation		Speed reference range Operation synchronized with inputs from pulser		
	Deceleration stop Deceleration time Deceleration time of the operation being active			
Stop function	Emergency stop Deceleration time 0 to 10,000 ms (Settable by 1 ms)			
	Limit stop Deceleration time 0 to 10,000 ms (Settable by 1 ms)			
	Error stop Deceleration time 0 to 10,000 ms (Settable by 1 ms)			
	System stop Deceleration time Immediate stop (0 ms)			

Type		4-axis type	8-axis type
Item	Part No.	AFP0HM4N	AFP0HM8N
Supported functions		Electronic gear, Electronic clutch, Electronic cam	
Synchronous functions	No. of axes	No. of synchronous groups 4 groups	
		Master axis Selectable from real axes, virtual axes and pulse inputs.	
	Slave axis Max. 8 axes per master axis		
	Electronic gear	Operation setting Gear ratio setting	
		Operation method Direct method, Linear acceleration / deceleration method	
	Electronic clutch	Trigger type Clutch ON trigger: Contact method Clutch OFF trigger: Contact input, The contact input + phase specification Contact method can be selected from the edge and level types.	
		Connection method Direct method, Linear slide method	
	Electronic cam	Cam curve Select from 20 types. Multiple curves can be specified within phase (0 to 100 %)	
		Resolution 1,024, 2,048, 4,096, 8,192, 16,384, 32,768	
		No. of cam patterns 4 to 16 (According to resolution)	
Cam pattern configuration method Cam curve method, Cam point method (set from Configurator PM7-RTEX)			
Other specifications	Software limit function	Setting range pulse : -2,147,482,624 to 2,147,482,624 pulse µm (0.1 µm) : -214,748,262.4 to 214,748,262.4 µm µm (1 µm) : -2,147,482,624 to 2,147,482,624 µm inch (0.00001 inch) : -21,474.82624 to 21,474.82624 inch inch (0.0001 inch) : -214,748.2624 to 214,748.2624 inch degree (0.1 degree) : -214,748,262.4 to 214,748,262.4 degree degree (1 degree) : -2,147,482,624 to 2,147,482,624 degree	
		Torque judgement Torque judgement: Selectable from Enabled / Disabled, Error / Warning 0.0 to 500.0 %	
	Monitor judgement Actual speed judgement Actual speed judgement: Selectable from Enabled / Disabled, Error / Warning 0 to 5,000 rpm		
Backup Parameters and positioning data are saved in the flash memory. (Battery less)			

\*1 "Servo motor with an absolute encoder" supported  
Absolute home return is performed in combination with A6-family servo motor with an absolute encoder.  
For servo drivers of A6NF and A6NE.  
Servo drivers with software of Ver. 1.24 (A6NF and A6NE) or later supported

## Product types

### Control units

Product name		Number of I/O points	Rated voltage	Input specifications	Output specifications	Connection method	SD memory card function	Part No.	
FP0H control units	Without Ethernet	Input: 16 points Output: 16 points	24 V DC	24 V DC (Polarity + / - common)	NPN transistor output: 0.3 A / 0.1 A	MIL connector	—	AFP0HC32T	
					PNP transistor output: 0.3 A			AFP0HC32P	
	With Ethernet				NPN transistor output: 0.3 A / 0.1 A			Built-in	AFP0HC32ET
					PNP transistor output: 0.3 A				AFP0HC32EP

### Expansion I/O units

Product name		Number of I/O points	Rated voltage	Input specifications	Output specifications	Connection method	Part No.
FP0H expansion unit	Sink type	Input: 32 points Output: 32 points	24 V DC	24 V DC (Polarity + / - common)	NPN transistor output: 0.1 A	MIL connector	AFP0HXY64D2T
	Source type				PNP transistor output: 0.1 A		AFP0HXY64D2P

### Communication cassettes

Product name	Specifications	Part No.
FP0H communication cassettes	RS-232C 1 channel	AFP0HCCS1
	RS-232C 2 channel	AFP0HCCS2
	RS-485 1 channel (insulated)	AFP0HCCM1
	RS-232C 1 channel and RS-485 1 channel (insulated)	AFP0HCCS1M1

### Positioning units

Product name	Output type	Number of occupied points	Number of axes controlled	Speed command	Part No.
FP0H positioning units	Transistor	Input 16 points, Output 16 points	1 axis	1 pps to 500 kpps	AFP0HPG01T
		Input 32 points, Output 32 points	2 axes		AFP0HPG02T
	Line driver	Input 16 points, Output 16 points	1 axis	1 pps to 4 Mpps	AFP0HPG01L
		Input 32 points, Output 32 points	2 axes		AFP0HPG02L

### Positioning RTEX units

Product name	Specifications	Part No.
FP0H positioning RTEX units	Network type, 4 axes, Connected to A5N / A6N manufactured by Panasonic Industry Co., Ltd.	AFP0HM4N
	Network type, 8 axes, Connected to A5N / A6N manufactured by Panasonic Industry Co., Ltd.	AFP0HM8N

### Expansion units (Common to FP0R)

Product name	Number of I/O points	Rated voltage	Input specifications	Output specifications	Connection type	Part No.	
FP0R-E8 expansion units	8 points	Input: 8 points	—	24 V DC ±common	—	MIL connector	AFP0RE8X
	8 points	Input: 4 points Output: 4 points	24 V DC	24 V DC ±common	Relay output: 2 A	Terminal block	AFP0RE8RS
					—	Molex connector	AFP0RE8RM
	8 points	Output: 8 points	24 V DC	—	Relay output: 2 A	Terminal block	AFP0RE8YRS
	8 points	Output: 8 points	—	—	NPN transistor output: 0.3 A	MIL connector	AFP0RE8YT
8 points	Output: 8 points	—	—	PNP transistor output: 0.3 A	MIL connector	AFP0RE8YP	
FP0R-E16 expansion units	16 points	Input: 16 points	—	24 V DC ±common	—	MIL connector	AFP0RE16X
	16 points	Input: 8 points Output: 8 points	24 V DC	24 V DC ±common	Relay output: 2 A	Terminal block	AFP0RE16RS
					—	Molex connector	AFP0RE16RM
	16 points	Input: 8 points Output: 8 points	—	—	NPN transistor output: 0.3 A	MIL connector	AFP0RE16T
	16 points	Input: 8 points Output: 8 points	—	—	PNP transistor output: 0.3 A	MIL connector	AFP0RE16P
	16 points	Output: 16 points	—	—	NPN transistor output: 0.3 A	MIL connector	AFP0RE16YT
16 points	Output: 16 points	—	—	PNP transistor output: 0.3 A	MIL connector	AFP0RE16YP	
FP0R-E32 expansion units	32 points	Input: 16 points	—	24 V DC ±common	NPN transistor output: 0.3 A	MIL connector	AFP0RE32T
		Output: 16 points	—	—	—	—	—
FP0R-E32 expansion units	32 points	Input: 16 points	—	24 V DC ±common	PNP transistor output: 0.3 A	MIL connector	AFP0RE32P
		Output: 16 points	—	—	—	—	—

Notes: 1) The relay output type expansion units come with a power cable (part number: **AFP0581**). (The transistor output type expansion units need no power cable.)

2) The terminal block type relay output units have two terminal blocks (9 pins) made by Phoenix. Use a 2.5 mm **0.098 in** wide screwdriver. Preferably use the specific terminal block screwdriver (part number: **AFP0806**, Phoenix type code SZS0, 4 × 2.5 mm **0.098 in**) or equivalent.

3) The connector type relay output units have two connectors made by Nihon Molex (Molex type code 51067-0900, 9 pins). Use the specific Molex connector press-fit tool (part number: **AFP0805**, Nihon Molex type code 57189-5000) or equivalent.

4) The transistor output units have a press-fit socket for wire-pressed terminal cable and contacts. Use the press-fit tool (part number: **AXY52000FP**) for wire-pressed terminal cable.

## Product types

### Expansion units (Common to FP0R)

Product name	Specifications	Product No.	Part No.
FP0R analog input unit	<Input specifications> Number or channels: 4 channels Voltage -10 to +10 V, -5 to +5 V, 0 to +10 V, 0 to +5 V (Resolution: 1/16,000) Current 0 to 20 mA (Resolution: 1/16,000)	—	AFP0RAD4
FP0R analog input unit	<Input specifications> Number or channels: 8 channels Voltage -10 to +10 V, -5 to +5 V, 0 to +10 V, 0 to +5 V (Resolution: 1/16,000) Current 0 to 20 mA (Resolution: 1/16,000)	—	AFP0RAD8
FP0R analog input and output unit	<Input specifications> Number or channels: 2 channels Voltage -10 to +10 V, -5 to +5 V, 0 to +10 V, 0 to +5 V (Resolution: 1/16,000) Current 0 to 20 mA (Resolution: 1/16,000) <Output specifications> Number or channels: 1 channel Voltage -10 to +10 V, -5 to +5 V, 0 to +10 V, 0 to +5 V (Resolution: 1/16,000) Current 0 to 20 mA, 4 to 20 mA (Resolution: 1/16,000)	—	AFP0RA21
FP0R analog input and output unit	<Input specifications> Number or channels: 4 channels Voltage -10 to +10 V, -5 to +5 V, 0 to +10 V, 0 to +5 V (Resolution: 1/16,000) Current 0 to 20 mA (Resolution: 1/16,000) <Output specifications> Number or channels: 2 channels Voltage -10 to +10 V, -5 to +5 V, 0 to +10 V, 0 to +5 V (Resolution: 1/16,000) Current 0 to 20 mA, 4 to 20 mA (Resolution: 1/16,000)	—	AFP0RA42
FP0R analog output unit	<Output specifications> Number or channels: 4 channels Voltage -10 to +10 V, -5 to +5 V, 0 to +10 V, 0 to +5 V (Resolution: 1/16,000) Current 0 to 20 mA, 4 to 20 mA (Resolution: 1/16,000)	—	AFP0RDA4
FP0 thermocouple units	K, J, T and R thermocouple, 4 channels, Resolution: 0.1 °C	FP0-TC4	AFP0420
	K, J, T and R thermocouple, 8 channels, Resolution: 0.1 °C	FP0-TC8	AFP0421
FP0 CC-Link slave unit	Unit to connect to FP0 CC-link	FP0-CCLS	AFP07943

### Programming tools





Product name	Supported version	Supported OS	Part No.
Programming software for Windows® Control FPWIN GR7	Ver. 2.18.0 or later (Positioning RTEX units: Ver. 2.26.0 or later)	Windows®11 (64-bit) / Windows®10 (32-bit / 64-bit) / Windows®8.1 (32-bit / 64-bit) / Windows®8 (32-bit / 64-bit) / Windows®7 SP1 or later (32-bit / 64-bit)	Japanese version
			Security enhanced type
			English version
			Security enhanced type
Programming software for Windows® Control FPWIN Pro7	Ver. 7.2.0 or later (Positioning RTEX units: Ver. 7.3.0.0 or later)	Windows®11 (64-bit) / Windows®10 (32-bit / 64-bit) / Windows®8.1 (32-bit / 64-bit) / Windows®8 (32-bit / 64-bit) / Windows®7 SP1 or later (32-bit / 64-bit)	English, Japanese, Korean and Chinese
			Security enhanced type

Notes: 1) Windows is trademarks or registered trademarks of Microsoft Corporation in the United States and other countries.  
2) Please use a commercially available USB2.0 cable (A type mini B) for connecting a control unit with a PC.

### Option

Product name	Specifications	Part No.
Backup battery	Required for backup of the data registers and when the calendar timer feature is used.	AFPX-BATT

### Others

Product name	Shape	Descriptions	Part No.
Power cable		Cable length 1 m 3.281 ft Supplied with FP0H control unit.	AFP805
Scattered wire connector set (40 pins)		Supplied with FP0H control unit Supplied with FP0H expansion I/O unit. (including 2 pcs.)	AFP2801
Multi-wire connector pressure contact tool		Necessary when wiring connectors in the supplied discrete-wire connector set to FP0H control unit or FP0H expansion I/O unit.	AXY52000FP
Flat cable connector set (40 pins)		For FP0H control unit and FP0H expansion I/O unit. Used when flat cables are used for bulk wiring. (including 2 pcs.)	AFP2802



# WH series Lineup

## List of related products [Web-based HMI] Programmable display WH series



### Add “IoT” to machines with the displays Ready for Industrial IoT

Providing new information to the production site with web technology  
Wide selection of screen sizes up to 21.5 inch wide

#### Advanced model WHA1

- 16,770,000 colors
- Max. 21.5 inch
- SD memory card
- Capacitive type
- Front pure glass
- Web server

Equipped with 3 Ethernet ports\* and a capacitive type, the large, high end model enables gesture control.

#### Standard model WHS1

- 65,536 colors
- Resistive film type
- Web server

Standard model with mid-sized, wide resistive film type for users with focused needs.

\*AWHA1C050 is equipped with two Ethernet ports.



	AWHA1C215	AWHA1C156	AWHA1C101	AWHA1C070	AWHA1C050		AWHS1R101	AWHS1R070	AWHS1R043
Screen size	21.5 inch wide	15.6 inch wide	10.1 inch wide	7 inch wide	5 inch wide	Screen size	10.1 inch wide	7 inch wide	4.3 inch wide
Resolution	Full HD 1920 × 1080	HD 1366 × 768	WXGA 1280 × 800	WVGA 800 × 480	WVGA 800 × 480	Resolution	WSVGA 1024 × 600	WVGA 800 × 480	WQVGA 480 × 272
Memory (RAM)	2 GB	2 GB	1 GB	1 GB	512 MB	Memory (RAM)	512 MB	512 MB	512 MB

## Main unit

Type	Descriptions						Part No.	
	Display	Touch switch	Power supply	Communication		USB		SD
				Ethernet	Serial			
Advanced model	21.5 inch wide TFT	Capacitive type	24 V DC	3 ports	1 port RS-232C / RS-422 / RS-485 *Software configurable	2 ports	1 slot	AWHA1C215
	15.6 inch wide TFT							AWHA1C156
	10.1 inch wide TFT							AWHA1C101
	7.0 inch wide TFT							AWHA1C070
	5.0 inch wide TFT							AWHA1C050
Standard model	10.1 inch wide TFT	Resistive film type		1 port		1 port		AWHS1R101
	7.0 inch wide TFT							AWHS1R070
	4.3 inch wide TFT							AWHS1R043

## Tool software

Product name	Descriptions	Remarks
<b>xAscender Studio</b>	Screen configuration tool for WH series programmable displays	You can download “xAscender Suite” for free from our website. (Membership registration is required.) “xAscender Suite” includes “xAscender Studio” and “xAscender Client”.
<b>xAscender Client</b>	Tool to enable remote viewing of WH series programmable displays	

## Control FPCWIN Pro7 (IEC 61131-3 compliant Windows® version software)



Compliant with international standard IEC 61131-3. Programming software approved by PLCopen

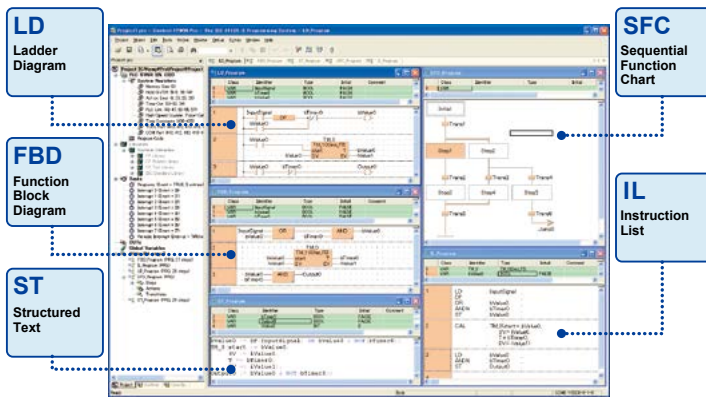

### Features

#### 1. Five programming languages can be used.

Programming can be done using the language most familiar to the developer or using the language most suited to the process to be performed. High-level (structured text) languages that allow structuring, such as C, are supported.

#### 2. Easy to reuse well-proven programs

Efficiency when writing programs has been greatly increased by being able to split programming up for each function and process using structured programming.

#### 3. Keep know-how from getting out

By "black box" a part of a program, you can prevent know-how from leaking out and improve the program's maintainability.

#### 4. Uploading of source programs from PLC possible.

Maintainability increased by being able to load programs and comments from the PLC.

#### 5. Programming for all models in the FP series possible.

#### • Programming in the language most suited to the process

Easy-to-understand, efficient programs can be created, for example, by using a ladder program for machine control or ST for communications control.

#### • Programming in the various language

Programming time can be greatly reduced by the easy ability to split and then integrate programming for each function and process.

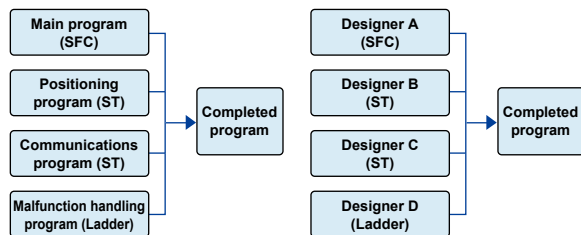

### Operational Environment

OS	Windows® 7 SP1 or later (32-bit / 64-bit) / Windows®8 (32-bit / 64-bit) / Windows®8.1 (32-bit / 64-bit) / Windows®10 (32-bit / 64-bit) / Windows®11 (64-bit) *1
Available hard disk space	400 MB or more
Recommended CPU	Intel®Core™ 2 Duo 2 GHz or more *2
Recommended system RAM	1 GB or more
Recommended display resolution	1,280 × 800 or more
Applicable PLCs	All FP series / BX

\*1 Windows is trademarks or registered trademarks of Microsoft Corporation in the United States and other countries.

\*2 Intel and Intel Core are trademarks or registered trademarks of Intel Corporation or its subsidiaries in the U.S. and/or other countries.

\*3 Board controller BX can be used when selecting "FP-XC30R" in PLC model selection.

## Control FPCWIN GR7 (Windows® version software)

The ladder programming software for FP series. Highly operational software tool for maximizing convenience in the field

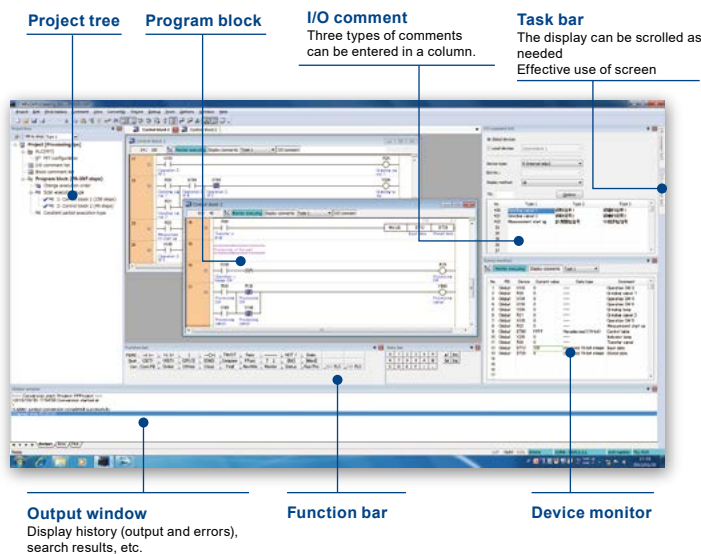

### Features

#### 1. To minimize effort and maximize ease of use, keyboard operability has been improved.

#### 2. Programs can be created in block segments.

#### 3. Wizard makes it easy to create positioning program.

### Operational Environment

OS	Windows® 7 SP1 or later (32-bit / 64-bit) / Windows®8 (32-bit / 64-bit) / Windows®8.1 (32-bit / 64-bit) / Windows®10 (32-bit / 64-bit) / Windows®11 (64-bit) *1
Available hard disk space	120 MB or more
Recommended CPU	Intel® Core™2 Duo 2 GHz or more *2
Recommended system RAM	1 GB or more
Recommended display resolution	1,280 × 800 or more
Applicable PLCs	FP7 / FP0H / FP0R / FP-X / FP-XH / FP-X0 / FPΣ / FP2SH / BX *3

\*1 Windows is trademarks or registered trademarks of Microsoft Corporation in the United States and other countries.

\*2 Intel and Intel Core are trademarks or registered trademarks of Intel Corporation or its subsidiaries in the U.S. and/or other countries.

\*3 For FP0H, supported from Ver. 2.18. For FP0H positioning RTEX units, supported from Ver. 2.26. For FP0R, supported from Ver. 2.9.  
(For creating divided programs, FP0R version 1.20 or later is required.)  
For FP-XH, supported from Ver. 2.16.1.  
For FP-X / FP-X0 / FPΣ / FP2SH, supported from Ver. 2.14.

\*Board controller BX can be used when selecting "FP-XC30R" in PLC model selection.

**Dimensions (Unit: mm in)**

The CAD data can be downloaded from our website.

**AFP0HC32T AFP0HC32P Control units**

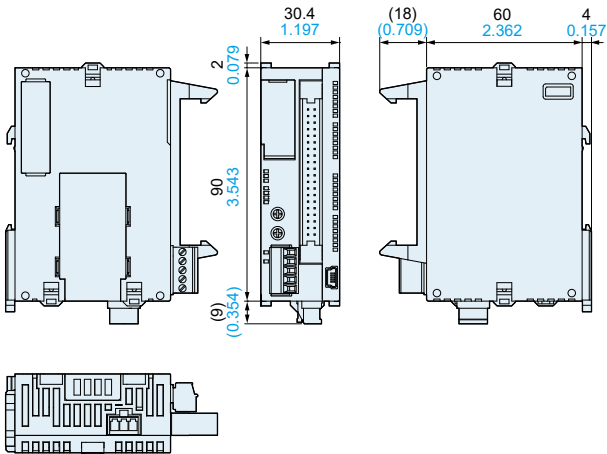

**AFP0HC32ET AFP0HC32EP Control units**

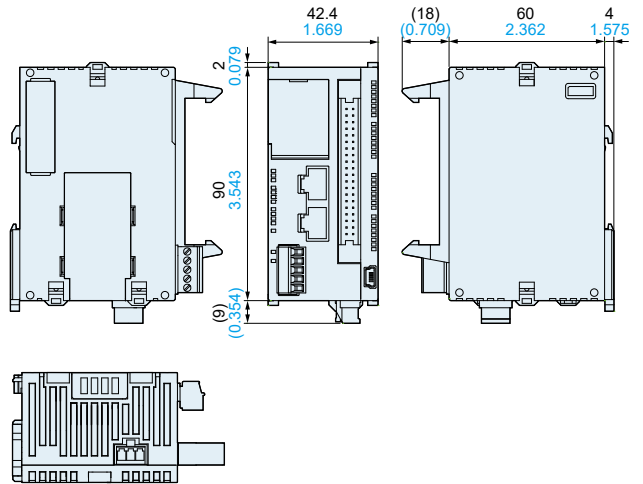

**AFP0HXY64D2T AFP0HXY64D2P Expansion I/O units**

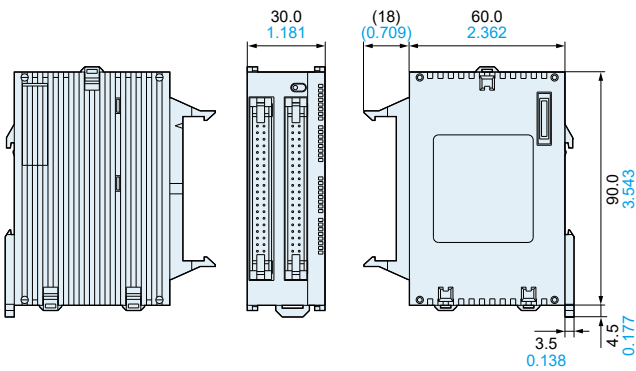

**AFP0HPG01T AFP0HPG01L AFP0HPG02T AFP0HPG02L Positioning units**

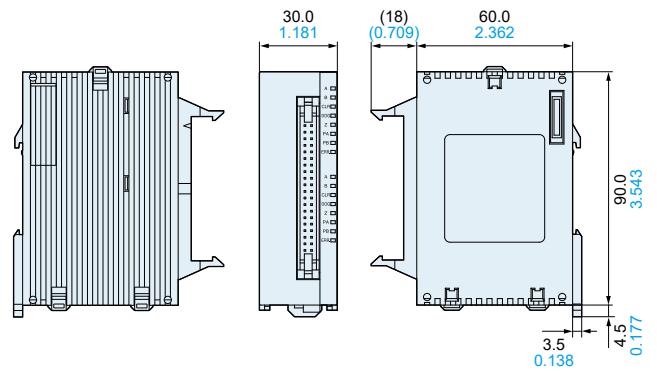

**AFP0HM4N AFP0HM8N Positioning RTEX units**

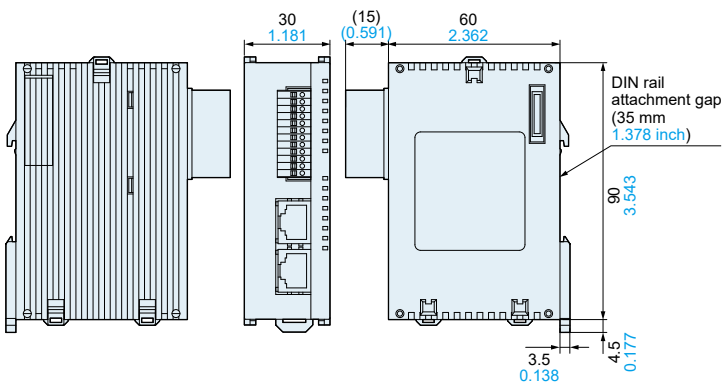

**AFP0HCCS1 AFP0HCCS2 AFP0HCCM1 AFP0HCCS1M1 Communication cassettes**

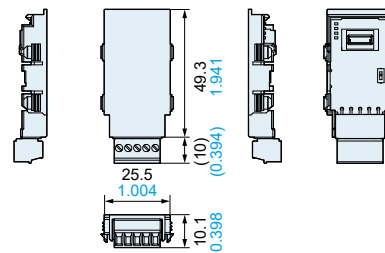

## Disclaimer

The applications described in the catalog are all intended for examples only. The purchase of our products described in the catalog shall not be regarded as granting of a license to use our products in the described applications. We do NOT warrant that we have obtained some intellectual properties, such as patent rights, with respect to such applications, or that the described applications may not infringe any intellectual property rights, such as patent rights, of a third party.

**Panasonic**  
INDUSTRY

**Panasonic Industry Co., Ltd.**

Industrial Device Business Division  
7-1-1, Morofuku, Daito-shi, Osaka 574-0044, Japan  
[industrial.panasonic.com/ac/e/](http://industrial.panasonic.com/ac/e/)