

SUMMARY

Wires

Low	4
High	0
Coax	0
Triax	0
Quad	0
Fiber	0
Fluidic	0

Series	0B
Termination type	Male solder
IP rating	50
Cable Ø	4.30 - 5.20 mm
Status	active
Alternative part	
Matching parts	EGG.0B.304.CLL PHG.0B.304.CLLD52



Image is for illustrative purpose only

Download

[Request a quote](#)

[Catalog](#)

[See video assembly instructions](#)

TECHNICAL DETAILS

Mechanics

Shell Style/Model	FG*: Straight plug, cable collet
Keying	1 key (alpha=0, plug: male contacts, receptacle: female contacts)
Housing Material	Brass (chrome plated) shell and collet nut, nickel plated brass latch sleeve and mid pieces
Variant	
Weight	8.29 g

Performance

Configuration	0B.304 : 4 Low Voltage
Insulator	L: PEEK (UL 94 / V-0/3.2, depends on material thickness)
Rated Current	7 Amps

Specifications

Contact Type: Solder
Contact Dia.: 0.7 mm (0.028in)
Bucket Dia.: 0.8 mm (0.031in)

LEMO products and services are provided "as is". LEMO makes no warranties or representations with regard to LEMO product & services or use of them, express, implied or statutory, including for accuracy, completeness, or security. The user is fully responsible for his products and applications using LEMO components.

Max. Stranded Conductor: 0.34 mm² (AWG 22)
 Max. Conductor: 0.34 mm² (AWG 22)
 R (max): 6.1 mOhm
 Vtest (contact-contact): 850 V (AC), 1200 V (DC)
 Vtest (contact-shell): 700 V (AC), 1000 V (DC)

Others

Endurance (Shell): 5000
 Temp (min / max): -55°C / +250°C
 Humidity (max): ≤95% [at 60 deg C / 140 F]
 Vibration: 15 g [10 Hz - 2000 Hz]
 Shock Resistance: 100 g [6 ms]
 Climatical Category: 50/175/21
 Shielding (min): 75 dB (10 MHz)
 Shielding (min): 40 dB (1 GHz)
 Salt Spray Corrosion: >1000 hr
 IP Rating: 50

DRAWINGS

Draws

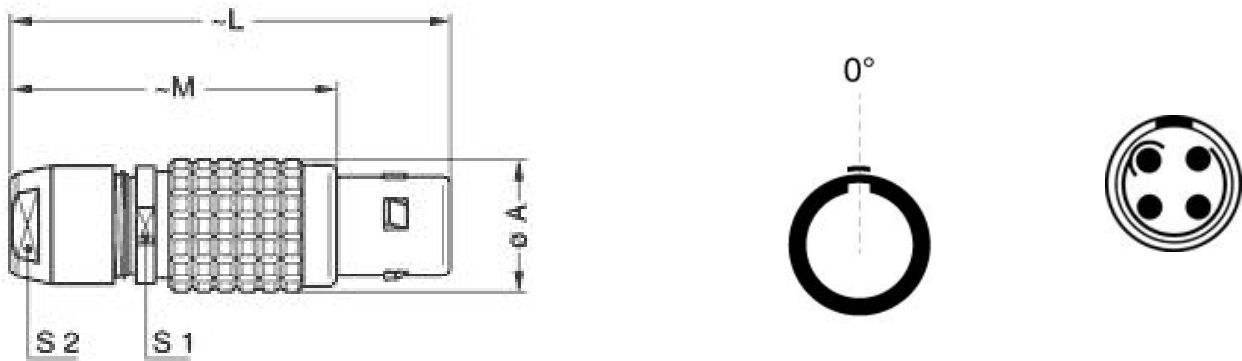

Dimensions

	A	L	M	S1	S2
mm.	9.5	36	26	8	7
in.	0,37	1,42	1,02	0,31	0,28











LEMO products and services are provided "as is". LEMO makes no warranties or representations with regard to LEMO product & services or use of them, express, implied or statutory, including for accuracy, completeness, or security. The user is fully responsible for his products and applications using LEMO components.

RECOMMENDED BY LEMO

Tools

Spanner wrench: DCD.0B.005.PA070
Caps: BFG.0B.100.PCSG

Cables

CMN.04.T22.047PGCE	PVC	GREY	
CMN.04.T22.047PNCE	PVC	Black	
CMN.04.T22.048QGZE	TPR (medical)	Grey	
CMN.04.T22.047PGZE		Grey	
CMN.04.T22.047PNZE			
CMN.04.T22.047QGC	TPR	Grey	
004 080	PVC	Grey	
004 221	PVC	Black	
004 280	PVC	Black	
040 260	PVC	Black	
080 080	PVC	Grey	
080 082	PVC	Red	
080 084	PVC	Black	
140 240	PVC	Black	
140 250	PVC	Grey	

LEMO products and services are provided "as is". LEMO makes no warranties or representations with regard to LEMO product & services or use of them, express, implied or statutory, including for accuracy, completeness, or security. The user is fully responsible for his products and applications using LEMO components.