



**MICROCHIP**

---

**3DTouchPad  
User's Guide**

---

**Note the following details of the code protection feature on Microchip devices:**

- Microchip products meet the specification contained in their particular Microchip Data Sheet.
- Microchip believes that its family of products is one of the most secure families of its kind on the market today, when used in the intended manner and under normal conditions.
- There are dishonest and possibly illegal methods used to breach the code protection feature. All of these methods, to our knowledge, require using the Microchip products in a manner outside the operating specifications contained in Microchip's Data Sheets. Most likely, the person doing so is engaged in theft of intellectual property.
- Microchip is willing to work with the customer who is concerned about the integrity of their code.
- Neither Microchip nor any other semiconductor manufacturer can guarantee the security of their code. Code protection does not mean that we are guaranteeing the product as "unbreakable."

Code protection is constantly evolving. We at Microchip are committed to continuously improving the code protection features of our products. Attempts to break Microchip's code protection feature may be a violation of the Digital Millennium Copyright Act. If such acts allow unauthorized access to your software or other copyrighted work, you may have a right to sue for relief under that Act.

---

Information contained in this publication regarding device applications and the like is provided only for your convenience and may be superseded by updates. It is your responsibility to ensure that your application meets with your specifications. MICROCHIP MAKES NO REPRESENTATIONS OR WARRANTIES OF ANY KIND WHETHER EXPRESS OR IMPLIED, WRITTEN OR ORAL, STATUTORY OR OTHERWISE, RELATED TO THE INFORMATION, INCLUDING BUT NOT LIMITED TO ITS CONDITION, QUALITY, PERFORMANCE, MERCHANTABILITY OR FITNESS FOR PURPOSE. Microchip disclaims all liability arising from this information and its use. Use of Microchip devices in life support and/or safety applications is entirely at the buyer's risk, and the buyer agrees to defend, indemnify and hold harmless Microchip from any and all damages, claims, suits, or expenses resulting from such use. No licenses are conveyed, implicitly or otherwise, under any Microchip intellectual property rights.

**Trademarks**

The Microchip name and logo, the Microchip logo, dsPIC, FlashFlex, flexPWR, JukeBlox, KEELOQ, KEELOQ logo, Kleer, LANCheck, MediaLB, MOST, MOST logo, MPLAB, OptoLyzer, PIC, PICSTART, PIC<sup>32</sup> logo, RightTouch, SpyNIC, SST, SST Logo, SuperFlash and UNI/O are registered trademarks of Microchip Technology Incorporated in the U.S.A. and other countries.

The Embedded Control Solutions Company and mTouch are registered trademarks of Microchip Technology Incorporated in the U.S.A.

Analog-for-the-Digital Age, BodyCom, chipKIT, chipKIT logo, CodeGuard, dsPICDEM, dsPICDEM.net, ECAN, In-Circuit Serial Programming, ICSP, Inter-Chip Connectivity, KleerNet, KleerNet logo, MiWi, MPASM, MPF, MPLAB Certified logo, MPLIB, MPLINK, MultiTRAK, NetDetach, Omniscient Code Generation, PICDEM, PICDEM.net, PICkit, PICtail, RightTouch logo, REAL ICE, SQI, Serial Quad I/O, Total Endurance, TSHARC, USBCheck, VariSense, ViewSpan, WiperLock, Wireless DNA, and ZENA are trademarks of Microchip Technology Incorporated in the U.S.A. and other countries.

SQTP is a service mark of Microchip Technology Incorporated in the U.S.A.

Silicon Storage Technology is a registered trademark of Microchip Technology Inc. in other countries.

GestIC is a registered trademarks of Microchip Technology Germany II GmbH & Co. KG, a subsidiary of Microchip Technology Inc., in other countries.

All other trademarks mentioned herein are property of their respective companies.

© 2014, Microchip Technology Incorporated, Printed in the U.S.A., All Rights Reserved.

ISBN: 978-1-63276-826-1

**QUALITY MANAGEMENT SYSTEM**  
**CERTIFIED BY DNV**  
**== ISO/TS 16949 ==**

*Microchip received ISO/TS-16949:2009 certification for its worldwide headquarters, design and wafer fabrication facilities in Chandler and Tempe, Arizona; Gresham, Oregon and design centers in California and India. The Company's quality system processes and procedures are for its PIC<sup>®</sup> MCUs and dsPIC<sup>®</sup> DSCs, KEELOQ<sup>®</sup> code hopping devices, Serial EEPROMs, microperipherals, nonvolatile memory and analog products. In addition, Microchip's quality system for the design and manufacture of development systems is ISO 9001:2000 certified.*

**Object of Declaration: 3DTouchPad**

EU Declaration of Conformity

This declaration of conformity is issued by the manufacturer.

The development/evaluation tool is designed to be used for research and development in a laboratory environment. This development/evaluation tool is not a Finished Appliance, nor is it intended for incorporation into Finished Appliances that are made commercially available as single functional units to end users under EU EMC Directive 2004/108/EC and as supported by the European Commission's Guide for the EMC Directive 2004/108/EC (8<sup>th</sup> February 2010).

This development/evaluation tool complies with EU RoHS2 Directive 2011/65/EU.

For information regarding the exclusive, limited warranties applicable to Microchip products, please see Microchip's standard terms and conditions of sale, which are printed on our sales documentation and available at [www.microchip.com](http://www.microchip.com).

Signed for and on behalf of Microchip Technology Inc. at Chandler, Arizona, USA

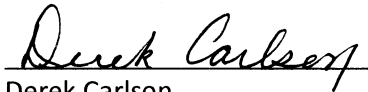

Derek Carlson  
VP Development Tools

16-July-2013  
Date

---

---

**Table of Contents**

---

---

<b>Preface</b> .....	<b>5</b>
<b>Chapter 1. 3DTouchPad Overview</b>	
1.1 Introduction .....	10
<b>Chapter 2. Package Content and Installation</b>	
2.1 Getting Started .....	11
<b>Chapter 3. Feature Description</b>	
<b>Chapter 4. Hardware</b>	
4.1 Introduction .....	13
4.2 Hardware Setup .....	13
4.3 3D Gesture Recognition .....	14
4.4 2D Touch Pad .....	14
4.5 Communication .....	15
4.6 Operating Modes and LED Indications .....	15
<b>Chapter 5. 3DTouchPad GUI</b>	
5.1 Introduction .....	16
5.2 Colibri Suite Tab .....	16
5.3 Setup Tab .....	19
<b>Worldwide Sales and Service</b> .....	<b>20</b>

---

---

**Preface**

---

---

**NOTICE TO CUSTOMERS**

All documentation becomes dated, and this manual is no exception. Microchip tools and documentation are constantly evolving to meet customer needs, so some actual dialogs and/or tool descriptions may differ from those in this document. Please refer to our web site ([www.microchip.com](http://www.microchip.com)) to obtain the latest documentation available.

Documents are identified with a “DS” number. This number is located on the bottom of each page, in front of the page number. The numbering convention for the DS number is “DSXXXXA”, where “XXXX” is the document number and “A” is the revision level of the document.

For the most up-to-date information on development tools, see the MPLAB® IDE online help. Select the Help menu, and then Topics to open a list of available online help files.

**INTRODUCTION**

This chapter contains general information that will be useful to know before using the 3DTouchPad. Items discussed in this chapter include:

- Document Layout
- Conventions Used in this Guide
- Warranty Registration
- Recommended Reading
- The Microchip Web Site
- Development Systems Customer Change Notification Service
- Customer Support
- Document Revision History

**DOCUMENT LAYOUT**

This document describes the 3DTouchPad and is organized as follows:

- **Chapter 1. 3DTouchPad Overview**
- **Chapter 2. Package Content and Installation**
- **Chapter 3. Feature Description**
- **Chapter 4. Hardware**
- **Chapter 5. 3DTouchPad GUI**

# 3DTouchPad User's Guide

## CONVENTIONS USED IN THIS GUIDE

This manual uses the following documentation conventions:

### DOCUMENT CONVENTIONS

Description	Represents	Examples
<b>Arial font:</b>		
Italic characters	Referenced books	<i>MPLAB IDE User's Guide</i>
	Emphasized text	...is the <i>only</i> compiler...
Initial caps	A window	the Output window
	A dialog	the Settings dialog
	A menu selection	select Enable Programmer
Quotes	A field name in a window or dialog	"Save project before build"
Underlined, italic text with right angle bracket	A menu path	<u><i>File&gt;Save</i></u>
Bold characters	A dialog button	Click <b>OK</b>
	A tab	Click the <b>Power</b> tab
N'Rnnnn	A number in verilog format, where N is the total number of digits, R is the radix and n is a digit.	4'b0010, 2'hF1
Text in angle brackets < >	A key on the keyboard	Press <Enter>, <F1>
<b>Courier New font:</b>		
Plain Courier New	Sample source code	#define START
	Filenames	autoexec.bat
	File paths	c:\mcc18\h
	Keywords	_asm, _endasm, static
	Command-line options	-Opa+, -Opa-
	Bit values	0, 1
	Constants	0xFF, 'A'
Italic Courier New	A variable argument	<i>file.o</i> , where <i>file</i> can be any valid filename
Square brackets [ ]	Optional arguments	mcc18 [options] <i>file</i> [options]
Curly brackets and pipe character: {   }	Choice of mutually exclusive arguments; an OR selection	errorlevel {0 1}
Ellipses...	Replaces repeated text	var_name [, var_name...]
	Represents code supplied by user	void main (void) { ... }

## WARRANTY REGISTRATION

Please complete the enclosed Warranty Registration Card and mail it promptly. Sending in the Warranty Registration Card entitles users to receive new product updates. Interim software releases are available at the Microchip web site.

## RECOMMENDED READING

This user's guide describes how to use the 3DTouchPad. Other useful documents are listed below. The following Microchip documents are available and recommended as supplemental reference resources.

- *"MGC3130 Single-Zone 3D Tracking and Gesture Controller Data Sheet"* (DS40001667) – Consult this document for advance information on GestIC<sup>®</sup> technology and MGC3130.
- *"MGC3130 GestIC<sup>®</sup> Technology Quick Start Guide"* (DS40001736) – Use this document for an overview of GestIC technology-related documentation and tools.

# 3DTouchPad User's Guide

---

## THE MICROCHIP WEB SITE

Microchip provides online support via our web site at [www.microchip.com](http://www.microchip.com). This web site is used as a means to make files and information easily available to customers. Information about the 3DTouchPad can be directly accessed via <http://www.microchip.com/3dtouchpad>.

## DEVELOPMENT SYSTEMS CUSTOMER CHANGE NOTIFICATION SERVICE

Microchip's customer notification service helps keep customers current on Microchip products. Subscribers will receive e-mail notification whenever there are changes, updates, revisions or errata related to a specified product family or development tool of interest.

To register, access the Microchip web site at [www.microchip.com](http://www.microchip.com), click on Customer Change Notification and follow the registration instructions.

The Development Systems product group categories are:

- **Compilers** – The latest information on Microchip C compilers, assemblers, linkers and other language tools. These include all MPLAB<sup>®</sup> C compilers; all MPLAB assemblers (including MPASM<sup>™</sup> assembler); all MPLAB linkers (including MPLINK<sup>™</sup> object linker); and all MPLAB librarians (including MPLIB<sup>™</sup> object librarian).
- **Emulators** – The latest information on Microchip in-circuit emulators. This includes the MPLAB<sup>®</sup> REAL ICE<sup>™</sup> and MPLAB ICE 2000 in-circuit emulators.
- **In-Circuit Debuggers** – The latest information on the Microchip in-circuit debuggers. This includes MPLAB ICD 3 in-circuit debuggers and PICKit<sup>™</sup> 3 debug express.
- **MPLAB IDE** – The latest information on Microchip MPLAB IDE, the Windows Integrated Development Environment for development systems tools. This list is focused on the MPLAB IDE, MPLAB IDE Project Manager, MPLAB Editor and MPLAB SIM simulator, as well as general editing and debugging features.
- **Programmers** – The latest information on Microchip programmers. These include production programmers such as MPLAB REAL ICE in-circuit emulator, MPLAB ICD 3 in-circuit debugger and MPLAB PM3 device programmers. Also included are non-production development programmers such as PICSTART<sup>®</sup> Plus and PICKit 2 and 3.



## CUSTOMER SUPPORT

Users of Microchip products can receive assistance through several channels:

- Distributor or Representative
- Local Sales Office
- Field Application Engineer (FAE)
- Technical Support

Customers should contact their distributor, representative or field application engineer (FAE) for support. Local sales offices are also available to help customers.

Technical support is available through the web site at:

<http://www.microchip.com/support>.

## DOCUMENT REVISION HISTORY

### Revision A (August 2014)

- Initial release of the document.

### Revision B (November 2014)

- Updated Tables 3-1, 3-2; Changed PCAP product solution; Updated Figure 5-1; Updated Table 5-2.

---

---

**Chapter 1. 3DTouchPad Overview**

---

---

**1.1 INTRODUCTION**

The 3DTouchPad is a personal computer (PC) peripheral used to extend a 2D touch pad with 3D free space gestures. It utilizes Microchip's projected capacitive (PCAP) sensor solutions as well as Microchip's 3D gesture technology, GestIC®. The 3DTouchPad offers multi-finger tracking and surface gestures as well as free space 3D gestures above the surface.

The 3DTouchPad offers all features expected from a touch pad (precision, multi-finger tracking, multi-finger surface gestures, such as swipes and scrolling) to which it adds 3D hand gestures. It enables a more efficient, more productive usage of the touch pad area. For example, the 3DTouchPad will allow the user to control the flow of pictures by a wave of the hand or to control the volume of the speakers with a casual rotation.

No driver installation is needed for the 3DTouchPad; it will simply work out-of-the-box.

The 3DTouchPad is designed to be a comprehensive development platform, offering a fully documented Software Development Kit (SDK) as well as an Application Programming Interface (API). The SDK contains reference code and enables the development of applications, drivers and games.

**FIGURE 1-1: 3DTouchPad**



## Chapter 2. Package Content and Installation

---

---

### 2.1 GETTING STARTED

The 3DTouchPad package contains the 3DTouchPad, a mini USB cable and an information sheet. Please use the mini USB cable to connect the device to the PC.



No driver installation is required for the 3DTouchPad. It is automatically detected by Microsoft Windows® (Windows 7 and Windows 8.x) as a Human Interface Device (HID). The 3DTouchPad is ready for use as soon as the right LED of the 3DTouchPad lights up. Please see [Chapter 4. "Hardware"](#) for more details on LED indication.

**Note:** When the 3DTouchPad is connected to the PC for the first time, it may take several seconds (up to several minutes) until it is ready to use. A reboot of the PC may be required if prompted by the Operating System (OS).



**Chapter 3. Feature Description**

The default out-of-the-box feature set of the 3DTouchPad includes 2D positioning, 2D as well as 3D gestures, replacing keyboard and mouse inputs.

**TABLE 3-1: 2D FEATURE SET OVERVIEW**

Category	Action	Description	Equivalent Keyboard Command
	One-Finger Movement	Mouse Cursor Movement	—
	One-Finger Tap	Mouse Left Click	—
	One-Finger Double Tap	Mouse Double Left Click	—
	Two-Finger Tap	Mouse Right Click	—
	Two-Finger Slide (Up/Down)	Vertical Scroll	—
	Two-Finger Slide (Left/Right)	Horizontal Scroll	—
	Swipe from Right Edge	Open Charm Bar (Windows® 8 only)	Windows® Logo Key + C (VK_C)
	Swipe from Top	Toggle app Command (Windows® 8 only)	Windows logo key+Z
	Pinch-to-Zoom	Zoom	Ctrl + Mouse Wheel

**TABLE 3-2: 3D FEATURE SET OVERVIEW**

Category	Action	Description	Equivalent Keyboard Command
	East → West Flick	Back	Left Arrow Key
	West → East Flick	Forward	Right Arrow Key
	Double North → South Flick <sup>(1)</sup>	Close Application	ALT + F4
	Double South → North Flick <sup>(1)</sup>	Maximize Window	Windows® Logo Key + Up Arrow
	Airwheel Clockwise	Vertical Scroll (Up)	—
	Airwheel Counterclockwise	Vertical Scroll (Down)	—
	Wake-up on Approach	PC can be woken up from Power-Saving mode by approaching the sensor	Any Key

**Note 1:** A double flick is done by performing two flick gestures consecutively in a defined time window (2 seconds).

Please consult [Chapter 4. “Hardware”](#) and [Chapter 5. “3DTouchPad GUI”](#) for additional information if the 3DTouchPad is used for application and driver development.

---

---

**Chapter 4. Hardware**

---

---

**4.1 INTRODUCTION**

The 3DTouchPad consists of a single four-layer PCB enclosed by a plastic housing. The mini USB port provides connectivity to a USB port of a PC. Three LEDs indicate the operating modes: 2D, 3D and Debug mode.

**4.2 HARDWARE SETUP**

The 3DTouchPad PCB contains the 2D touch pad surrounded by the electrodes for 3D gesture recognition. The assembly is placed on the bottom of the PCB. [Figure 4-1](#) and [Figure 4-2](#) show the assembly as well as the electrode structures.

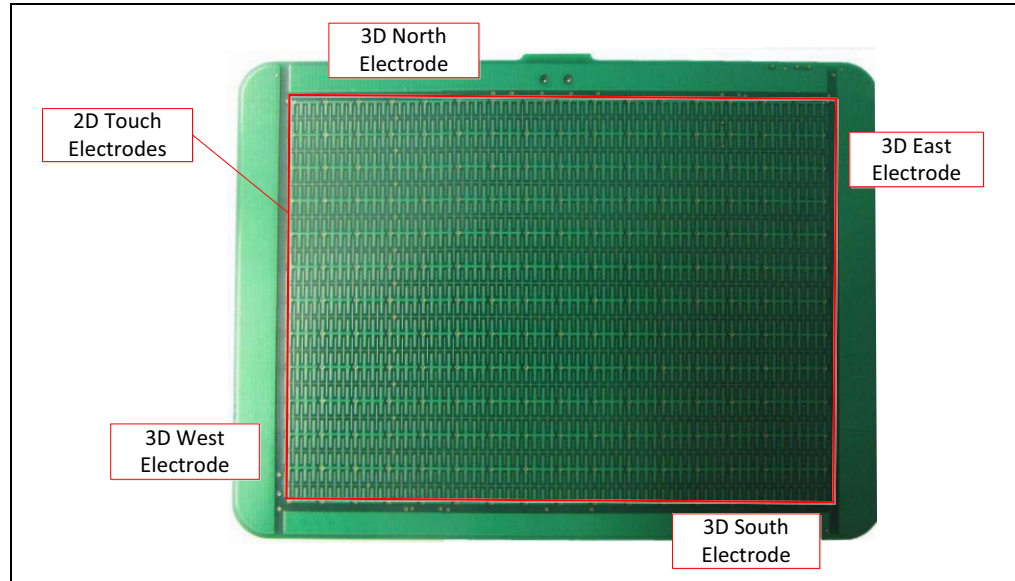
**FIGURE 4-1: PCB TOP VIEW**

# 3DTouchPad User's Guide

FIGURE 4-2: PCB BOTTOM VIEW

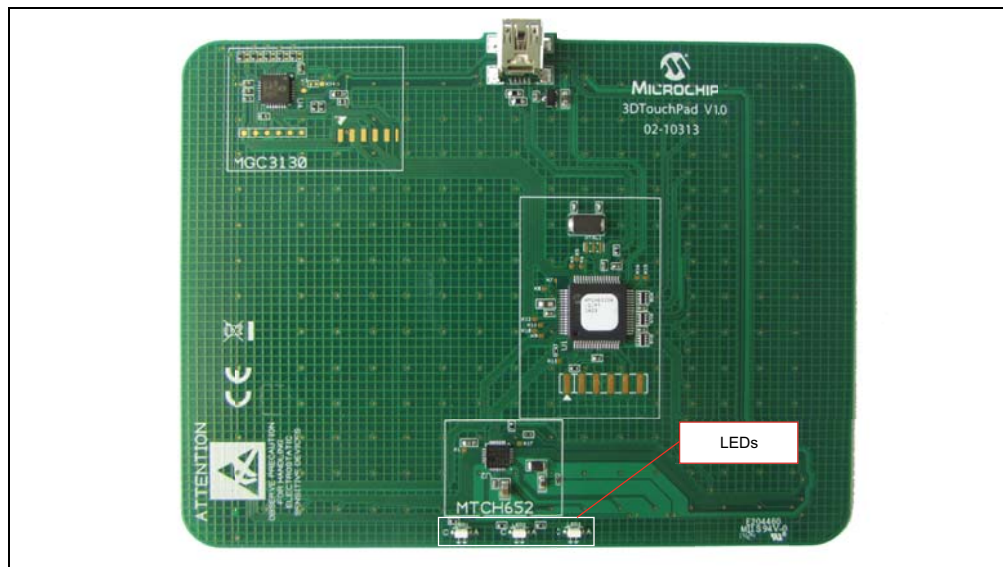

## 4.3 3D GESTURE RECOGNITION

3D gesture recognition is realized with Microchip's single-chip gesture solution, MGC3130. The MGC3130 is a gesture recognition, motion tracking and approach detection controller based on Microchip's patented GestIC technology. It enables user command input with natural hand movements while utilizing the principles of electrical near-field sensing. Please find more detailed information at [www.microchip.com/gestic](http://www.microchip.com/gestic).

MGC3130 is connected to four Rx frame electrodes (North, East, South and West) located at the top of the PCB and one transmit (Tx) electrode which covers a full middle layer of the PCB. The four Rx electrodes define the edges of the 3D sensing space (X and Y direction). The sensing space reaches a height of up to 70 mm (Z direction). Inside this sensing space, the user can perform free space gestures which are described in [Table 3-2](#).

## 4.4 2D TOUCH PAD

The 2D touch functionality is realized with Microchip's MTCH6XXX, a PIC32-based PCAP controller. It handles 12 Rx and 16 Tx nodes, which are located in the center of the PCB (top layer) in between the 3D GestIC Rx electrodes. The edges of the touch pad area are marked by a raised line on the top cover.

In order to ensure system stability and robustness, the PCAP Tx signal is driven by Microchip's MTCH652. MTCH652 is a Tx voltage booster solution which drives the Tx signal up to 18V.

The 2D touch pad allows tracking of up to ten fingers simultaneously. Besides the 2D multi-finger tracking functionality, a variety of surface gestures are implemented. These surface gestures allow for example two-finger scrolling. A complete overview of the 2D gestures is given in [Table 3-1](#).

## 4.5 COMMUNICATION

MGC3130 and MTCH6XXX communicate via I<sup>2</sup>C™ – MTCH6XXX as master and MGC3130 as slave. In addition to the I<sup>2</sup>C lines, there are two handshake lines which are used for the handover process between 3D and 2D operation. 2D as well as 3D information is sent to the PC by MTCH6XXX via the USB. Hereby, MTCH6XXX acts as a HID device.

**FIGURE 4-3: COMMUNICATION BLOCK DIAGRAM**

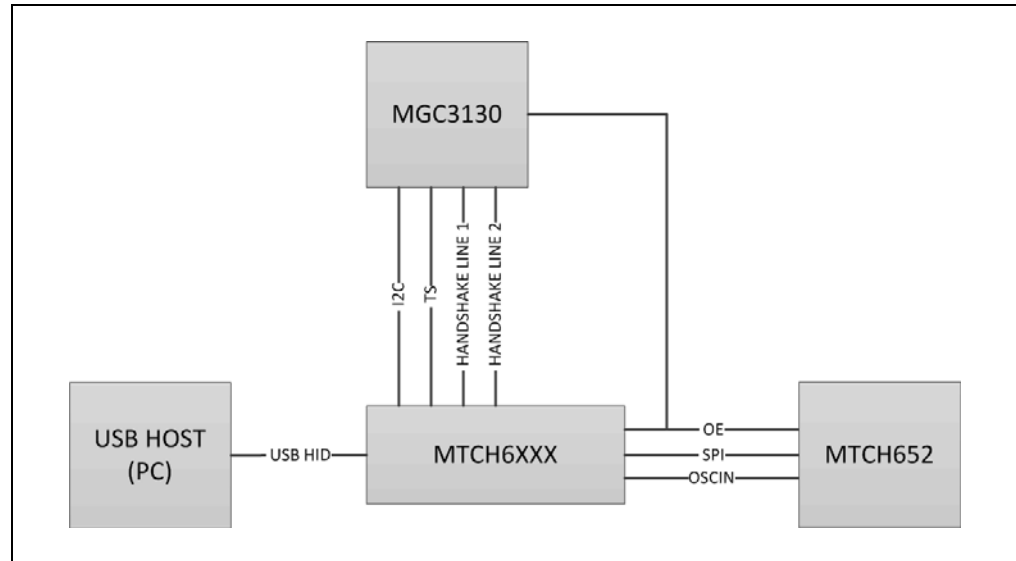

## 4.6 OPERATING MODES AND LED INDICATIONS

**FIGURE 4-4: LEDS SEEN FROM THE BACK**

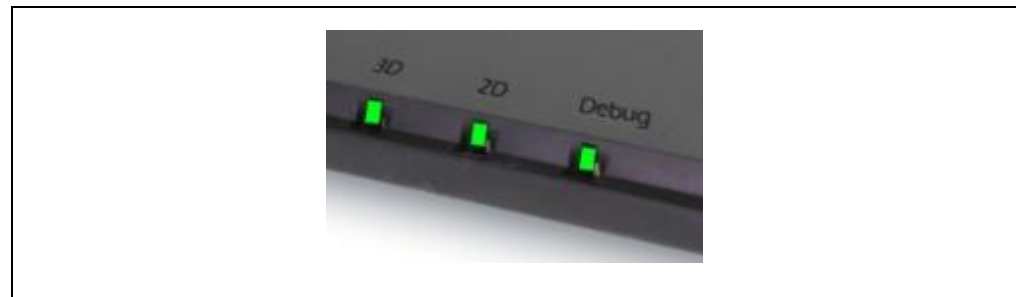

Three LEDs are placed on the bottom of the 3DTouchPad to indicate the operating mode (see [Figure 4-4](#)).

- LED 3 (indication for **3D mode**): Free space gestures such as flicks or Airwheel will be detected.
- LED 2 (indication for **2D mode**): If the user touches the surface of the pad, the mode will change automatically from 3D to 2D and this LED will light up. LED 3 will be switched off. Multi-finger tracking as well as surface gestures will be detected in this mode.
- LED 1 (indication for **Debug mode**): If Debug mode is enabled, neither 2D nor 3D information will be forwarded to the Windows HID interface. Hence, all built-in Windows OS control features are disabled. 2D and 3D information can be monitored in the 3DTouchPad GUI without effects on the OS. The Debug mode can be enabled and disabled in the 3DTouchPad GUI.





## Chapter 5. 3DTouchPad GUI

### 5.1 INTRODUCTION

The 3DTouchPad GUI is a central element of the development process using the 3DTouchPad. It can be downloaded for free from the 3DTouchPad site at [www.microchip.com/3dtouchpad](http://www.microchip.com/3dtouchpad).

The 3DTouchPad GUI provides two main sections:

- **Colibri Suite** tab
- **Setup** tab

Using the **Colibri Suite** tab, the user can observe and assess 2D as well as 3D performance. In the **Setup** tab, the user can perform firmware updates for both the MGC3130 and MTCH6XXX devices.

### 5.2 COLIBRI SUITE TAB

FIGURE 5-1: COLIBRI SUITE TAB

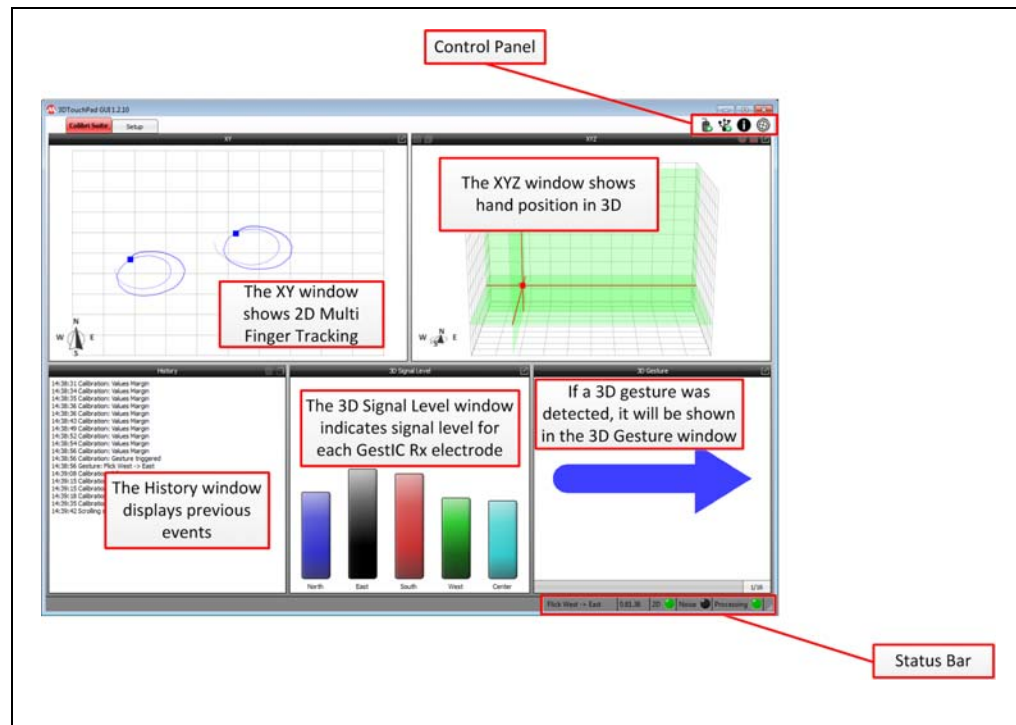



The **Colibri Suite** tab is divided into the following windows:

- The XY window, showing 2D multi-finger tracking
- The XYZ window, indicating the hand position in 3D mode
- The 3D Signal Level window, showing the signal level for each GestIC Rx electrode
- The History window, displaying 2D and 3D events in chronological order
- The 3D Gesture window, displaying all 3D gestures after successful detection

Please see [Table 5-1](#) for a list of all available free space gestures.

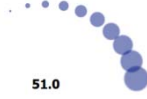
**TABLE 5-1: 3D GESTURES – THE 3D GESTURE WINDOW**

Symbol	Gesture
	Flicks in all four directions
	Airwheel with counter (clockwise and counterclockwise)
	Garbage model





For more information on these gestures, please refer to the “MGC3130 Aurea Graphical User Interface User’s Guide” (DS40001681).

**Note:** Only 3D gestures will be shown in the GUI. 2D surface gestures such as taps or swipes are not visualized.

# 3DTouchPad User's Guide

The control panel on the top right side offers additional functionality. Please see [Table 5-2](#) for the description of the control panel items.

**TABLE 5-2: CONTROL PANEL ITEMS**

Icon	Description
	Enable/Disable Debug mode
	Connect/Disconnect from 3DTouchPad GUI
	About
	Link to 3DTouchPad site ( <a href="http://www.microchip.com/3dtouchpad">www.microchip.com/3dtouchpad</a> )

The status bar is located at the bottom side of the GUI. It provides information about the recent status of the 3DTouchPad (see [Figure 5-2](#)).

The following information is displayed from left to right:

- Gesture Indication, which shows the latest recognized 3D free space gesture
- MGC3130 Firmware Version
- Operation Mode Indication, which lights up if the 3DTouchPad is in 2D mode; the indication is off if the pad is in 3D mode
- Noise Indication, which flashes when high noise is detected
- Processing Indication, which shows if the 3DTouchPad is working

**FIGURE 5-2: STATUS BAR**

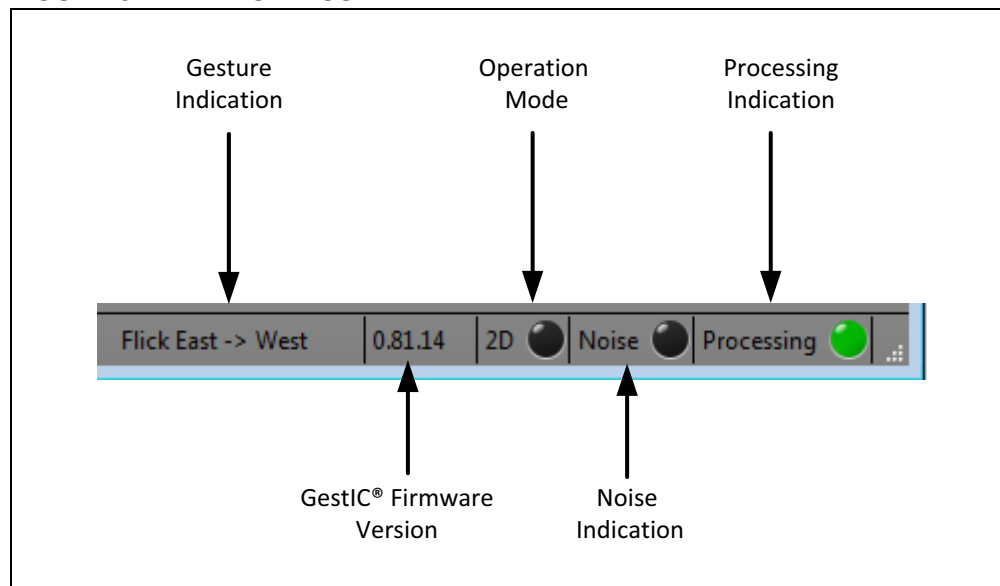

## 5.3 SETUP TAB

The firmware for both the MGC3130 and MTCH6XXX devices can be updated by clicking **Firmware Update**.

The 3DTouchPad GUI will then automatically update the latest firmware file for MGC3130 and MTCH6XXX.



# MICROCHIP

## Worldwide Sales and Service

### AMERICAS

#### Corporate Office

2355 West Chandler Blvd.  
Chandler, AZ 85224-6199  
Tel: 480-792-7200  
Fax: 480-792-7277  
Technical Support:  
<http://www.microchip.com/support>  
Web Address:  
[www.microchip.com](http://www.microchip.com)

#### Atlanta

Duluth, GA  
Tel: 678-957-9614  
Fax: 678-957-1455

#### Austin, TX

Tel: 512-257-3370

#### Boston

Westborough, MA  
Tel: 774-760-0087  
Fax: 774-760-0088

#### Chicago

Itasca, IL  
Tel: 630-285-0071  
Fax: 630-285-0075

#### Cleveland

Independence, OH  
Tel: 216-447-0464  
Fax: 216-447-0643

#### Dallas

Addison, TX  
Tel: 972-818-7423  
Fax: 972-818-2924

#### Detroit

Novi, MI  
Tel: 248-848-4000

#### Houston, TX

Tel: 281-894-5983

#### Indianapolis

Noblesville, IN  
Tel: 317-773-8323  
Fax: 317-773-5453

#### Los Angeles

Mission Viejo, CA  
Tel: 949-462-9523  
Fax: 949-462-9608

#### New York, NY

Tel: 631-435-6000

#### San Jose, CA

Tel: 408-735-9110

#### Canada - Toronto

Tel: 905-673-0699  
Fax: 905-673-6509

### ASIA/PACIFIC

#### Asia Pacific Office

Suites 3707-14, 37th Floor  
Tower 6, The Gateway  
Harbour City, Kowloon  
Hong Kong  
Tel: 852-2943-5100  
Fax: 852-2401-3431

#### Australia - Sydney

Tel: 61-2-9868-6733  
Fax: 61-2-9868-6755

#### China - Beijing

Tel: 86-10-8569-7000  
Fax: 86-10-8528-2104

#### China - Chengdu

Tel: 86-28-8665-5511  
Fax: 86-28-8665-7889

#### China - Chongqing

Tel: 86-23-8980-9588  
Fax: 86-23-8980-9500

#### China - Hangzhou

Tel: 86-571-8792-8115  
Fax: 86-571-8792-8116

#### China - Hong Kong SAR

Tel: 852-2943-5100  
Fax: 852-2401-3431

#### China - Nanjing

Tel: 86-25-8473-2460  
Fax: 86-25-8473-2470

#### China - Qingdao

Tel: 86-532-8502-7355  
Fax: 86-532-8502-7205

#### China - Shanghai

Tel: 86-21-5407-5533  
Fax: 86-21-5407-5066

#### China - Shenyang

Tel: 86-24-2334-2829  
Fax: 86-24-2334-2393

#### China - Shenzhen

Tel: 86-755-8864-2200  
Fax: 86-755-8203-1760

#### China - Wuhan

Tel: 86-27-5980-5300  
Fax: 86-27-5980-5118

#### China - Xian

Tel: 86-29-8833-7252  
Fax: 86-29-8833-7256

#### China - Xiamen

Tel: 86-592-2388138  
Fax: 86-592-2388130

#### China - Zhuhai

Tel: 86-756-3210040  
Fax: 86-756-3210049

### ASIA/PACIFIC

#### India - Bangalore

Tel: 91-80-3090-4444  
Fax: 91-80-3090-4123

#### India - New Delhi

Tel: 91-11-4160-8631  
Fax: 91-11-4160-8632

#### India - Pune

Tel: 91-20-3019-1500

#### Japan - Osaka

Tel: 81-6-6152-7160  
Fax: 81-6-6152-9310

#### Japan - Tokyo

Tel: 81-3-6880-3770  
Fax: 81-3-6880-3771

#### Korea - Daegu

Tel: 82-53-744-4301  
Fax: 82-53-744-4302

#### Korea - Seoul

Tel: 82-2-554-7200  
Fax: 82-2-558-5932 or  
82-2-558-5934

#### Malaysia - Kuala Lumpur

Tel: 60-3-6201-9857  
Fax: 60-3-6201-9859

#### Malaysia - Penang

Tel: 60-4-227-8870  
Fax: 60-4-227-4068

#### Philippines - Manila

Tel: 63-2-634-9065  
Fax: 63-2-634-9069

#### Singapore

Tel: 65-6334-8870  
Fax: 65-6334-8850

#### Taiwan - Hsin Chu

Tel: 886-3-5778-366  
Fax: 886-3-5770-955

#### Taiwan - Kaohsiung

Tel: 886-7-213-7830

#### Taiwan - Taipei

Tel: 886-2-2508-8600  
Fax: 886-2-2508-0102

#### Thailand - Bangkok

Tel: 66-2-694-1351  
Fax: 66-2-694-1350

### EUROPE

#### Austria - Wels

Tel: 43-7242-2244-39  
Fax: 43-7242-2244-393

#### Denmark - Copenhagen

Tel: 45-4450-2828  
Fax: 45-4485-2829

#### France - Paris

Tel: 33-1-69-53-63-20  
Fax: 33-1-69-30-90-79

#### Germany - Dusseldorf

Tel: 49-2129-3766400

#### Germany - Munich

Tel: 49-89-627-144-0  
Fax: 49-89-627-144-44

#### Germany - Pforzheim

Tel: 49-7231-424750

#### Italy - Milan

Tel: 39-0331-742611  
Fax: 39-0331-466781

#### Italy - Venice

Tel: 39-049-7625286

#### Netherlands - Drunen

Tel: 31-416-690399  
Fax: 31-416-690340

#### Poland - Warsaw

Tel: 48-22-3325737

#### Spain - Madrid

Tel: 34-91-708-08-90  
Fax: 34-91-708-08-91

#### Sweden - Stockholm

Tel: 46-8-5090-4654

#### UK - Wokingham

Tel: 44-118-921-5800  
Fax: 44-118-921-5820

03/25/14