

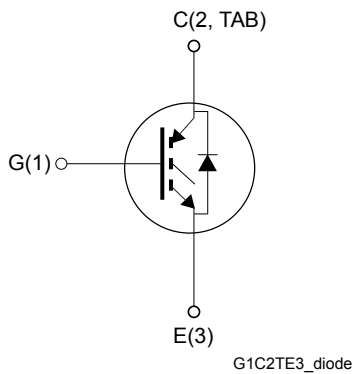

Automotive-grade trench gate field-stop 650 V, 80 A high speed HB series IGBT in a TO-247 long leads

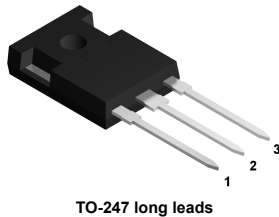

Features

- AEC-Q101 qualified 
- High-speed switching series
- Maximum junction temperature: $T_J = 175\text{ °C}$
- Low $V_{CE(sat)} = 1.65\text{ V (typ.) @ } I_C = 80\text{ A}$
- Minimized tail current
- Tight parameter distribution
- Positive temperature $V_{CE(sat)}$ coefficient
- Soft and very fast recovery antiparallel diode

Applications

- PFC
- High frequency converters

Description

This device is an IGBT developed using an advanced proprietary trench gate field-stop structure. The device is part of the new HB series of IGBTs, which represents an optimum compromise between conduction and switching loss to maximize the efficiency of any frequency converter. Furthermore, the slightly positive $V_{CE(sat)}$ temperature coefficient and very tight parameter distribution result in safer paralleling operation.

Product status link

[STGWA80H65DFBAG](#)

Product summary

Order code	STGWA80H65DFBAG
Marking	G80H65DFBAG
Package	TO-247 long leads
Packing	Tube

1 Electrical ratings

Table 1. Absolute maximum ratings

Symbol	Parameter	Value	Unit
V_{CES}	Collector-emitter voltage ($V_{GE} = 0\text{ V}$)	650	V
I_C	Continuous collector current at $T_C = 25\text{ °C}$	120 ⁽¹⁾	A
	Continuous collector current at $T_C = 100\text{ °C}$	80	
$I_{CP}^{(2)}$	Pulsed collector current ($t_p = 1\text{ ms}$)	240	A
V_{GE}	Gate-emitter voltage	± 20	V
	Transient gate-emitter voltage ($t_p \leq 10\text{ }\mu\text{s}$)	± 30	
I_F	Continuous forward current at $T_C = 25\text{ °C}$	120 ⁽¹⁾	A
	Continuous forward current at $T_C = 100\text{ °C}$	80	
$I_{FP}^{(2)}$	Pulsed forward current	240	A
P_{TOT}	Total power dissipation at $T_C = 25\text{ °C}$	535	W
T_{STG}	Storage temperature range	-55 to 150	°C
T_J	Operating junction temperature range	-55 to 175	°C

1. Current limited by package.
2. Pulse width is limited by maximum junction temperature.

Table 2. Thermal data

Symbol	Parameter	Value	Unit
R_{thJC}	Thermal resistance, junction-to-case IGBT	0.28	°C/W
	Thermal resistance, junction-to-case diode	0.41	
R_{thJA}	Thermal resistance, junction-to-ambient	50	°C/W

2 Electrical characteristics

$T_J = 25\text{ °C}$ unless otherwise specified.

Table 3. Static characteristics

Symbol	Parameter	Test conditions	Min.	Typ.	Max.	Unit
$V_{CE(sat)}$	Collector-emitter saturation voltage	$V_{GE} = 15\text{ V}, I_C = 80\text{ A}$		1.65	2.0	V
		$V_{GE} = 15\text{ V}, I_C = 80\text{ A}, T_J = 125\text{ °C}$		1.8		
		$V_{GE} = 15\text{ V}, I_C = 80\text{ A}, T_J = 175\text{ °C}$		1.9		
V_F	Forward on-voltage	$I_F = 80\text{ A}$		1.9		V
		$I_F = 80\text{ A}, T_J = 125\text{ °C}$		1.55		
		$I_F = 80\text{ A}, T_J = 175\text{ °C}$		1.4		
$V_{GE(th)}$	Gate threshold voltage	$V_{CE} = V_{GE}, I_C = 1\text{ mA}$	4.5	5.5	6.5	V

Table 4. Dynamic characteristics

Symbol	Parameter	Test conditions	Min.	Typ.	Max.	Unit
C_{ies}	Input capacitance	$V_{CE} = 25\text{ V}, f = 1\text{ MHz}, V_{GE} = 0\text{ V}$	-	10460	-	pF
C_{oes}	Output capacitance		-	390	-	pF
C_{res}	Reverse transfer capacitance		-	215	-	pF
Q_g	Total gate charge	$V_{CC} = 520\text{ V}, I_C = 80\text{ A}, V_{GE} = 0\text{ to }15\text{ V}$	-	453	-	nC

Table 5. Switching characteristics (inductive load)

Symbol	Parameter	Test conditions	Min.	Typ.	Max.	Unit
$t_{d(off)}$	Turn-off delay time	$V_{CC} = 400\text{ V}$, $I_C = 80\text{ A}$, $V_{GE} = 15\text{ V}$, $R_G = 10\ \Omega$	-	360	-	ns
t_r	Current rise time		-	84	-	ns
$di/dt_{(on)}$	Turn-on current slope		-	720	-	A/ μ s
$E_{on}^{(1)}$	Turn-on switching energy		-	3.26	-	mJ
$t_{d(off)}$	Turn-off delay time		-	360	-	ns
t_f	Current fall time		-	66	-	ns
$E_{off}^{(2)}$	Turn-off switching energy		-	2.33	-	mJ
E_{ts}	Total switching energy		-	5.59	-	mJ
$t_{d(off)}$	Turn-off delay time		$V_{CC} = 400\text{ V}$, $I_C = 80\text{ A}$, $V_{GE} = 15\text{ V}$, $R_G = 10\ \Omega$, $T_J = 175\text{ }^\circ\text{C}$	-	375	-
t_r	Current rise time	-		90	-	ns
$di/dt_{(on)}$	Turn-on current slope	-		690	-	A/ μ s
$E_{on}^{(1)}$	Turn-on switching energy	-		5.24	-	mJ
$t_{d(off)}$	Turn-off delay time	-		375	-	ns
t_f	Current fall time	-		65	-	ns
$E_{off}^{(2)}$	Turn-off switching energy	-		2.56	-	mJ
E_{ts}	Total switching energy	-		7.8	-	mJ

1. Including the reverse recovery of the diode.

2. Including the tail of the collector current.

Table 6. Diode switching characteristics (inductive load)

Symbol	Parameter	Test conditions	Min.	Typ.	Max.	Unit
t_{rr}	Reverse recovery time	$I_F = 80\text{ A}$, $V_R = 400\text{ V}$, $V_{GE} = 15\text{ V}$, $di/dt = 1000\text{ A}/\mu\text{s}$	-	64	-	ns
Q_{rr}	Reverse recovery charge		-	0.7	-	μC
I_{rrm}	Reverse recovery current		-	15	-	A
E_{rr}	Reverse recovery energy		-	92	-	μJ
t_{rr}	Reverse recovery time	$I_F = 80\text{ A}$, $V_R = 400\text{ V}$, $V_{GE} = 15\text{ V}$, $di/dt = 1000\text{ A}/\mu\text{s}$, $T_J = 175\text{ }^\circ\text{C}$	-	120	-	ns
Q_{rr}	Reverse recovery charge		-	3.7	-	μC
I_{rrm}	Reverse recovery current		-	47	-	A
E_{rr}	Reverse recovery energy		-	595	-	μJ

2.1 Electrical characteristics (curves)

Figure 1. Total power dissipation vs temperature

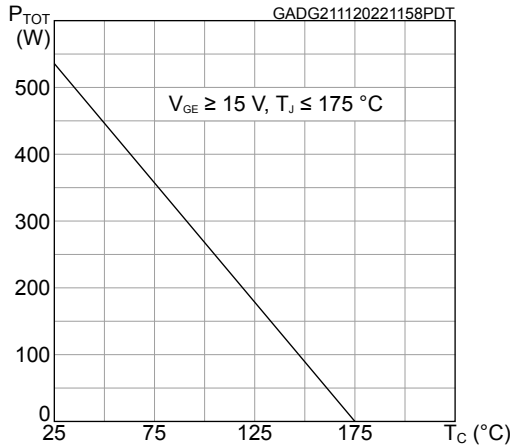

Figure 2. Collector current vs temperature

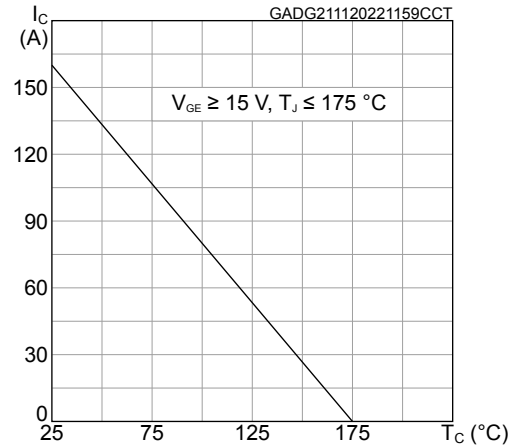

Figure 3. Typical output characteristics (T_J = 25 °C)

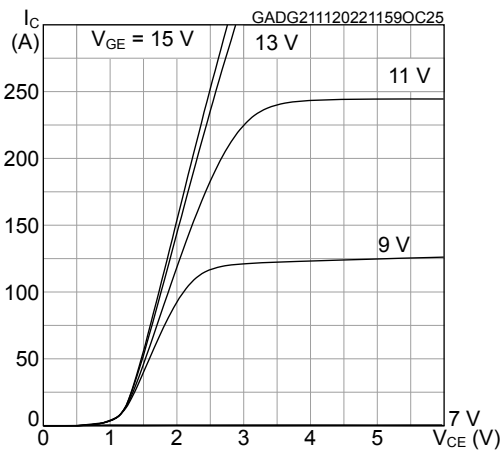

Figure 4. Typical output characteristics (T_J = 175 °C)

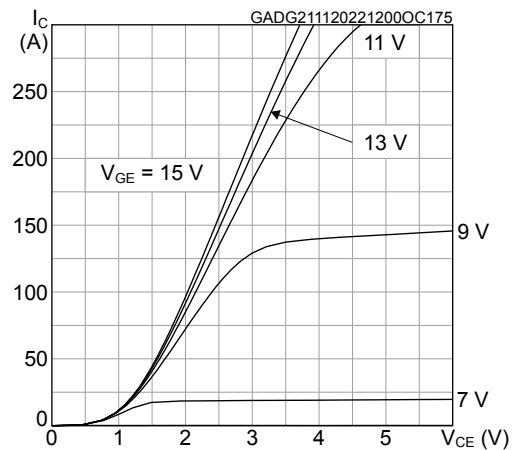

Figure 5. Typical V_{CE(sat)} vs temperature

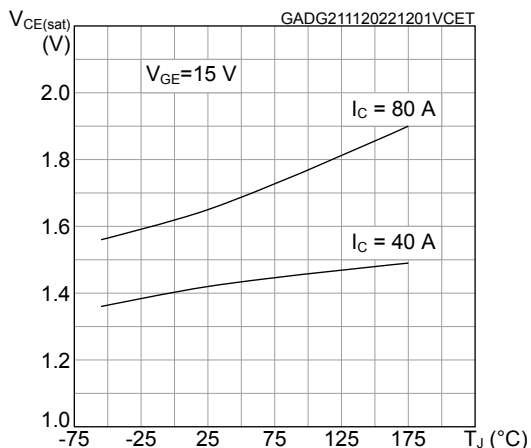

Figure 6. Typical V_{CE(sat)} vs collector current

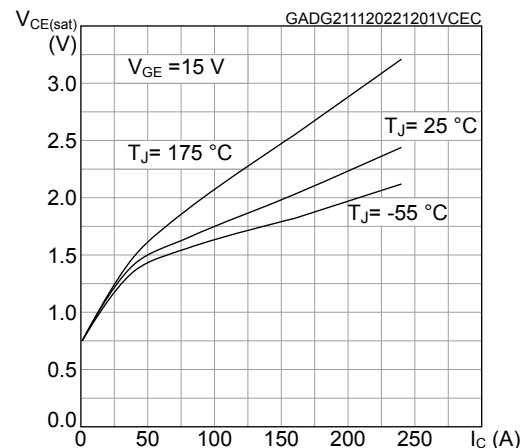

Figure 7. Forward bias safe operating area

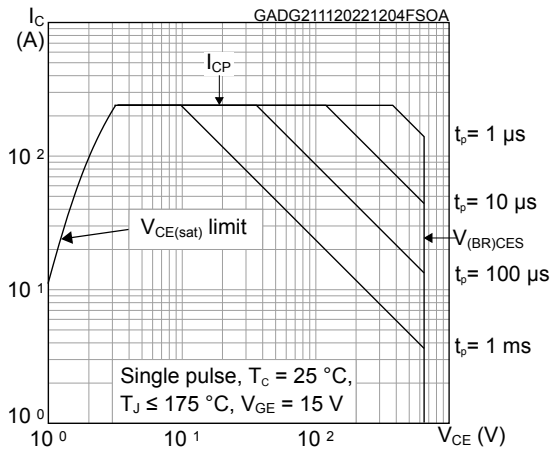

Figure 8. Collector current vs switching frequency

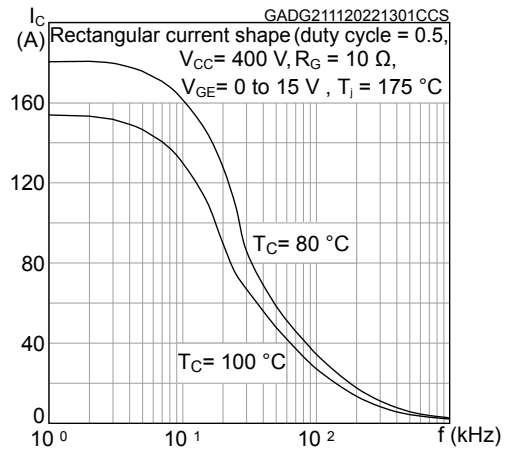

Figure 9. Typical transfer characteristics

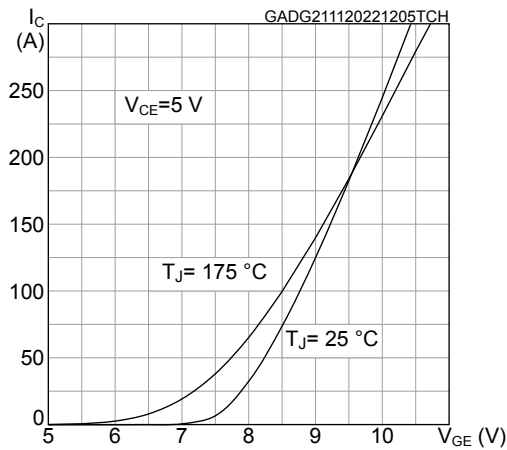

Figure 10. Typical diode V_F vs forward current

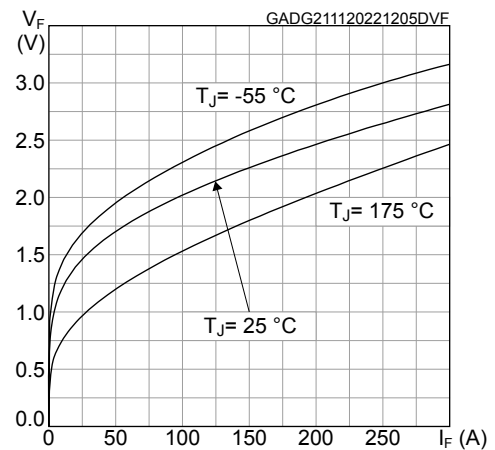

Figure 11. Normalized V_GE(th) vs temperature

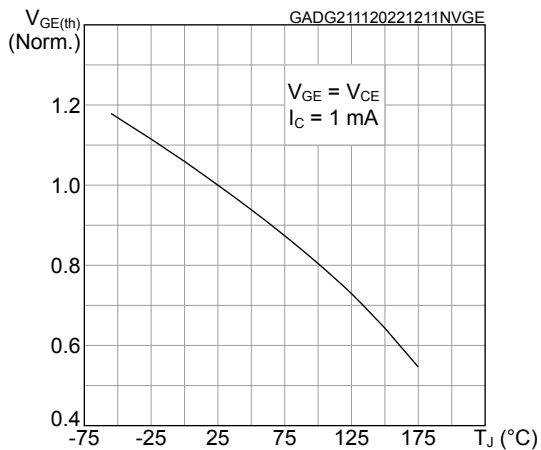

Figure 12. Normalized V_(BR)CES vs temperature

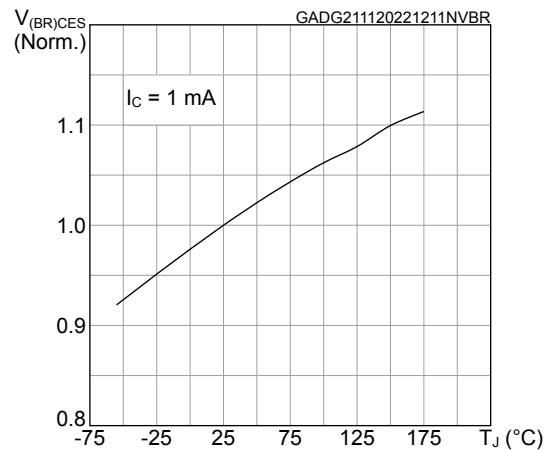

Figure 13. Typical capacitance characteristics

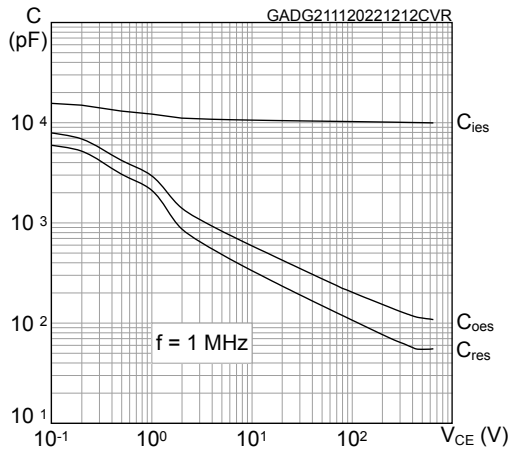

Figure 14. Typical gate charge characteristics

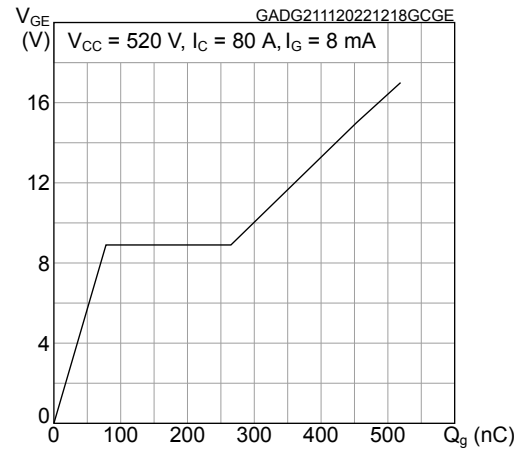

Figure 15. Typical switching energy vs collector current

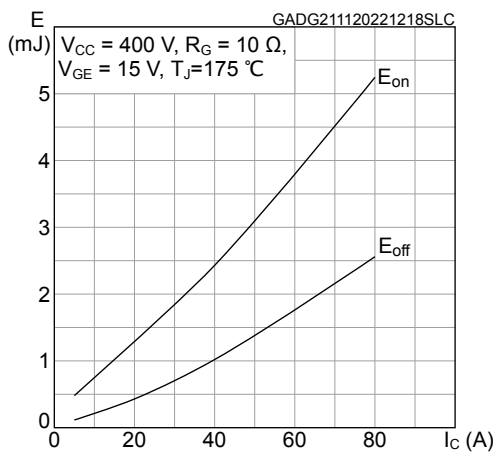

Figure 16. Typical switching energy vs temperature

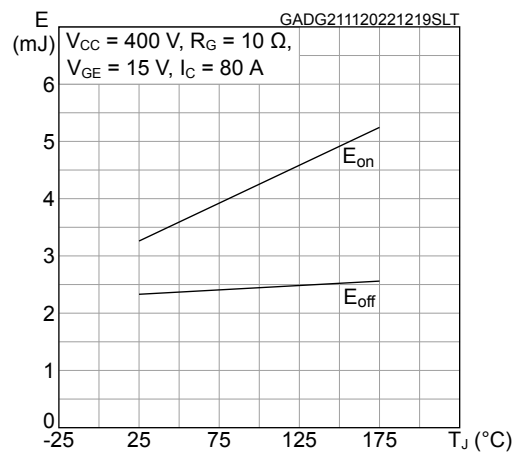

Figure 17. Typical switching energy vs collector emitter voltage

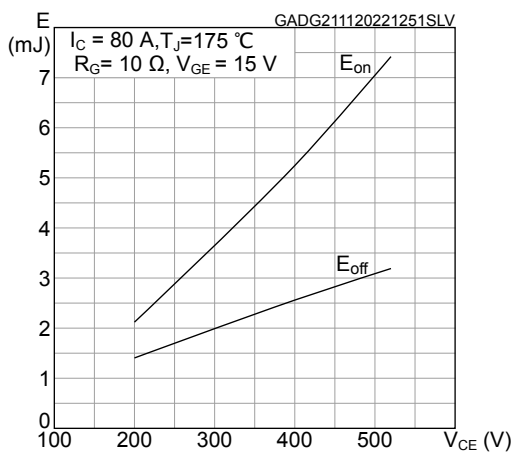

Figure 18. Typical switching energy vs R_G

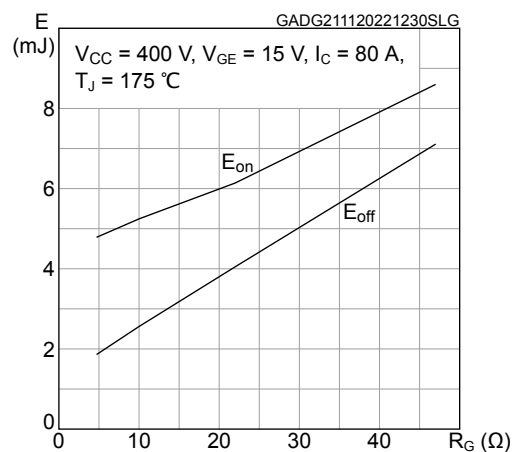

Figure 19. Typical switching times vs collector current

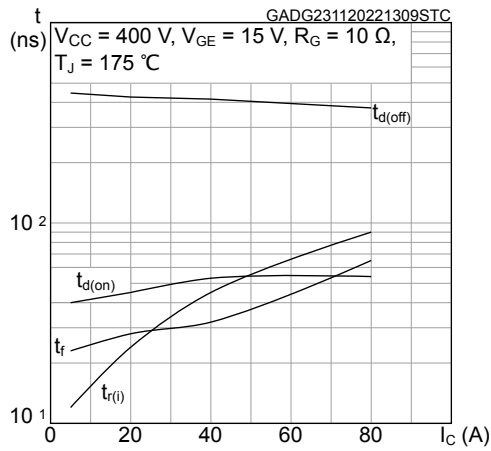

Figure 20. Typical switching times vs gate resistance

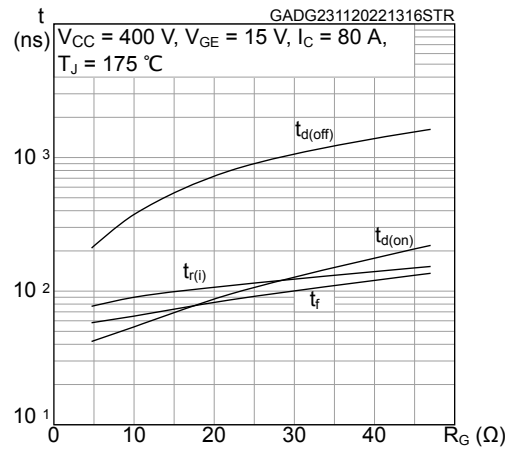

Figure 21. Typical reverse recovery current vs diode current slope

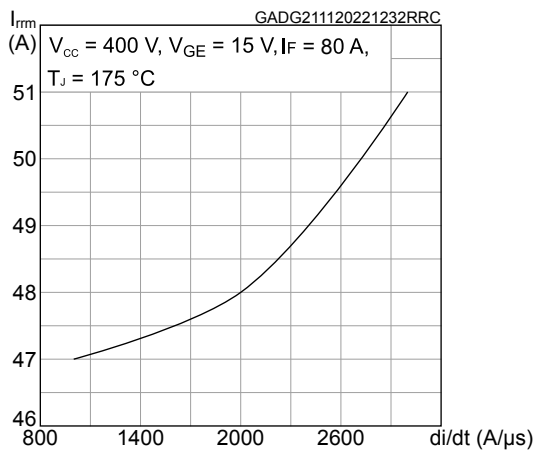

Figure 22. Typical reverse recovery time vs diode current slope

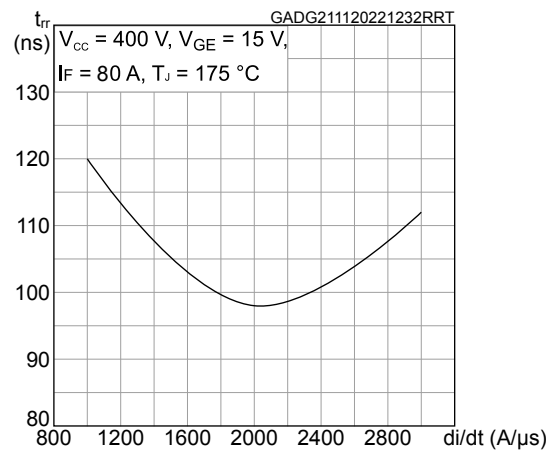

Figure 23. Typical reverse recovery charge vs diode current slope

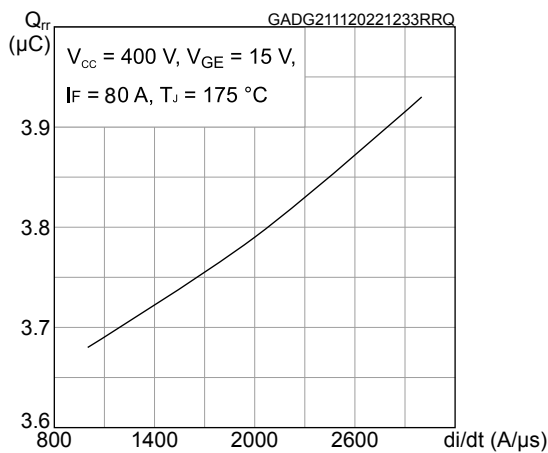

Figure 24. Typical reverse recovery energy vs diode current slope

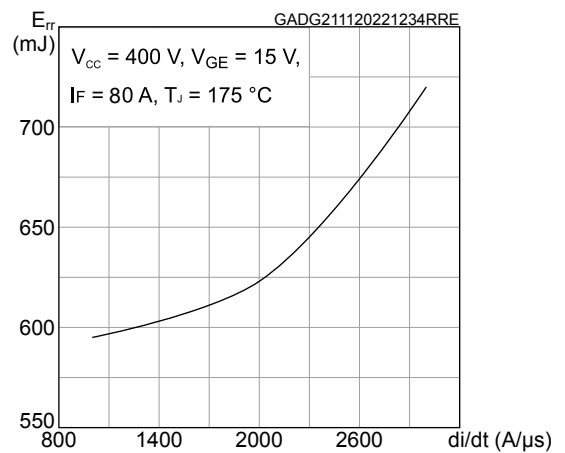

Figure 25. Maximum transient thermal impedance for IGBT

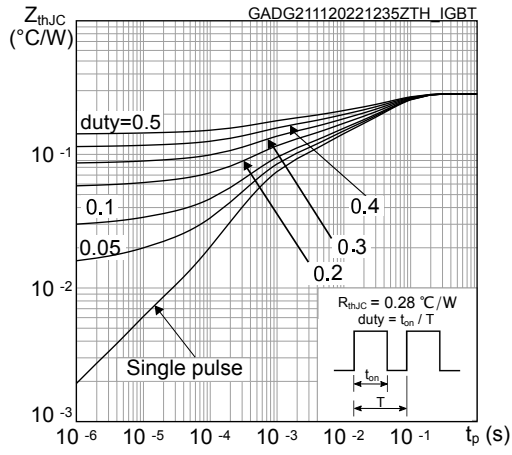
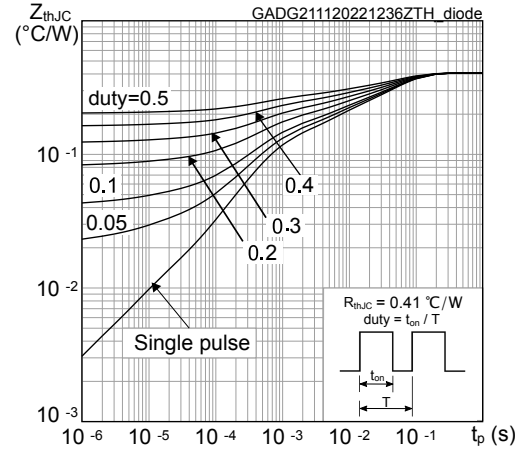

Figure 26. Maximum transient thermal impedance for diode



3 Package information

In order to meet environmental requirements, ST offers these devices in different grades of **ECOPACK** packages, depending on their level of environmental compliance. ECOPACK specifications, grade definitions and product status are available at: www.st.com. ECOPACK is an ST trademark.

3.1 TO-247 long leads package information

Figure 27. TO-247 long leads package outline

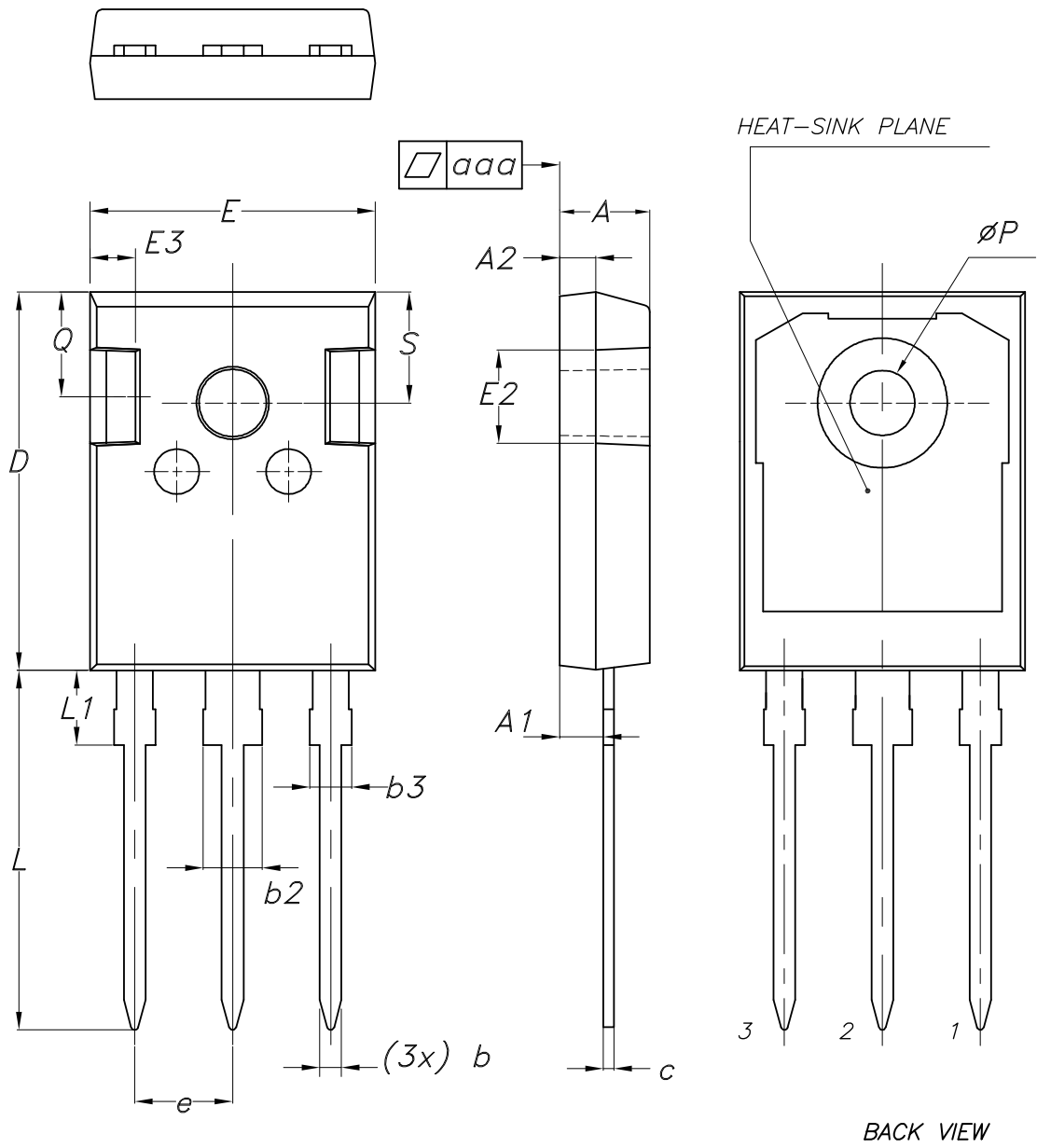

Table 7. TO-247 long leads package mechanical data

Dim.	mm		
	Min.	Typ.	Max.
A	4.90	5.00	5.10
A1	2.31	2.41	2.51
A2	1.90	2.00	2.10
b	1.16		1.26
b2			3.25
b3			2.25
c	0.59		0.66
D	20.90	21.00	21.10
E	15.70	15.80	15.90
E2	4.90	5.00	5.10
E3	2.40	2.50	2.60
e	5.34	5.44	5.54
L	19.80	19.92	20.10
L1			4.30
P	3.50	3.60	3.70
Q	5.60		6.00
S	6.05	6.15	6.25
aaa		0.04	0.10

Revision history

Table 8. Document revision history

Date	Revision	Changes
06-Dec-2022	1	First release.

Contents

1	Electrical ratings	2
2	Electrical characteristics	3
2.1	Electrical characteristics (curves)	5
3	Package information	10
3.1	TO-247 long leads package information	10
	Revision history	12

IMPORTANT NOTICE – READ CAREFULLY

STMicroelectronics NV and its subsidiaries (“ST”) reserve the right to make changes, corrections, enhancements, modifications, and improvements to ST products and/or to this document at any time without notice. Purchasers should obtain the latest relevant information on ST products before placing orders. ST products are sold pursuant to ST’s terms and conditions of sale in place at the time of order acknowledgment.

Purchasers are solely responsible for the choice, selection, and use of ST products and ST assumes no liability for application assistance or the design of purchasers’ products.

No license, express or implied, to any intellectual property right is granted by ST herein.

Resale of ST products with provisions different from the information set forth herein shall void any warranty granted by ST for such product.

ST and the ST logo are trademarks of ST. For additional information about ST trademarks, refer to www.st.com/trademarks. All other product or service names are the property of their respective owners.

Information in this document supersedes and replaces information previously supplied in any prior versions of this document.

© 2022 STMicroelectronics – All rights reserved