

NO.	MASSE / DIMENSION
A	2-18NS-2A
B	22.2
C	4
D	34.2
E	47.6
F	44.5
G	57
H	4.4

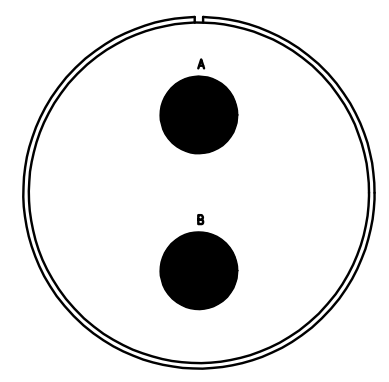
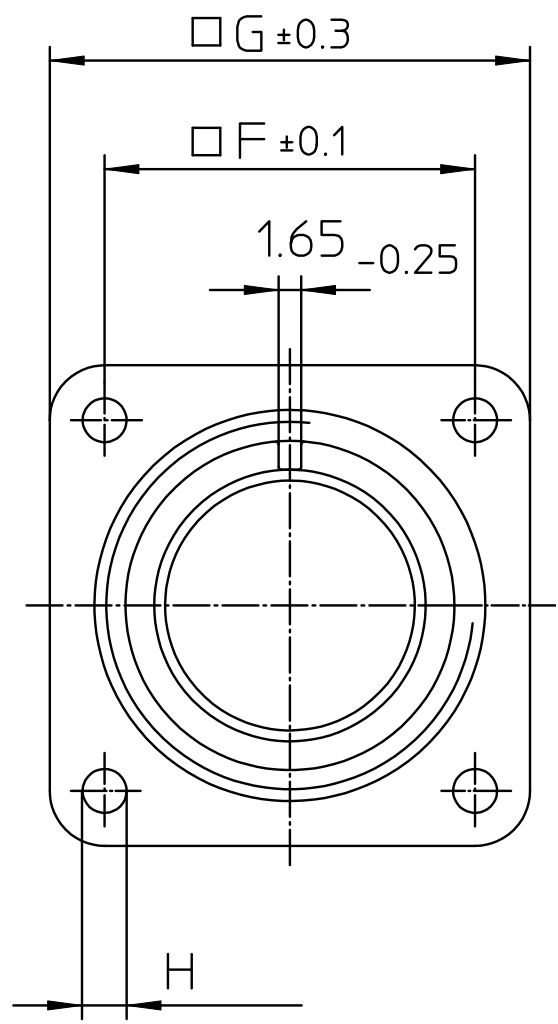
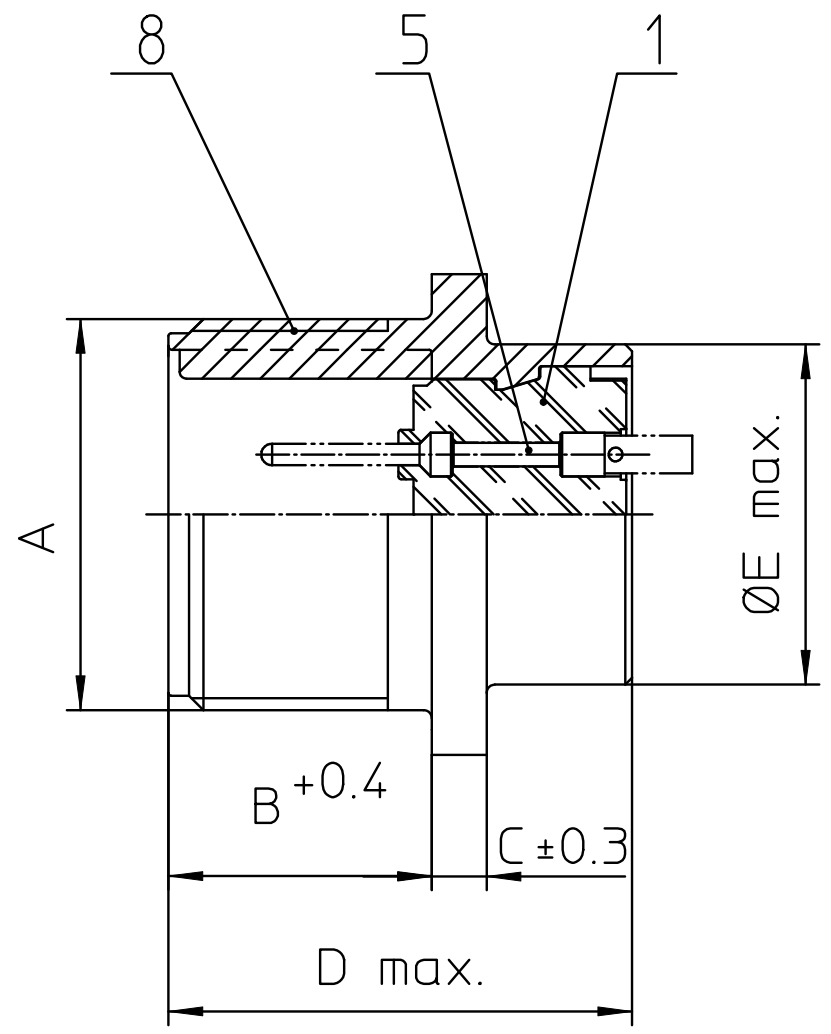

NO.	BESCHREIBUNG / DESCRIPTION
1	ISOLIERKÖRPER STIFT / INSULATOR PIN
5	KONTAKTSTIFT / CONTACT PIN
8	DOSENGEHÄUSE / SHELL

Note: Due to an automatic nomenclature system, numbers generated may not be sequential.
 Specification and Dimensions subject to change
 Drawings illustrate normal insulator positioning

Material Specification:	
Shell Material:	Aluminium alloy
Shell Plating:	Olive drab chromate coating over cadmium plating
Insulator Material:	Neoprene
Contact Material:	Copper alloy
Contact Plating:	Hard silver

all dimensions are in mm
 Dimensions without tolerance indications are general tolerances in acc. with DIN7168m

drawing for
CUSTOMER

description **CA3102E32-5P**
 Box mounting receptacle

ITT
 Engineered for life
 ITT CANNON GmbH
 D - 71384 Weinstadt/Germany

Solder Cup / Pin / Layout: 32-5