

QT-Brightek PLCC Series

Dome Type PLCC2 LED

Part No.: QBLP670D-IW-CW-2897

| | | |
|------------------------------|----------------------|--------------|
| Product: QBLP670D-IW-CW-2897 | Date: March 17, 2021 | Page 1 of 11 |
| | Version# 1.0 | |

Table of Contents:

| | |
|------------------------------------------------------|----|
| Introduction | 3 |
| Electrical / Optical Characteristic (Ta=25 °C) | 4 |
| Absolute Maximum Rating | 4 |
| CIE Chromaticity Diagram..... | 5 |
| Characteristic Curves..... | 6 |
| Solder Profile & Footprint..... | 7 |
| Recommended Handling Precautions..... | 8 |
| Packing | 9 |
| Ordering Information | 10 |
| Revision History | 11 |
| Disclaimer | 11 |

Introduction

Feature:

- Ultra bright dome type PLCC2 LED
- InGaN technology
- Clear lens
- Viewing angle: 30 deg typ.
- CCT: 6500K typ.

Description:

This dome type PLCC2 LED has a height profile of 3.6mm. Combination of high brightness output and robust package, this LED is ideal for architecture lighting, status indication, and color mixing applications.

Application:

- Status indication
- Industrial equipment backlighting
- Architecture lighting

Certification & Compliance:

- TS16949
- ISO9001
- RoHS Compliant



Dimension:

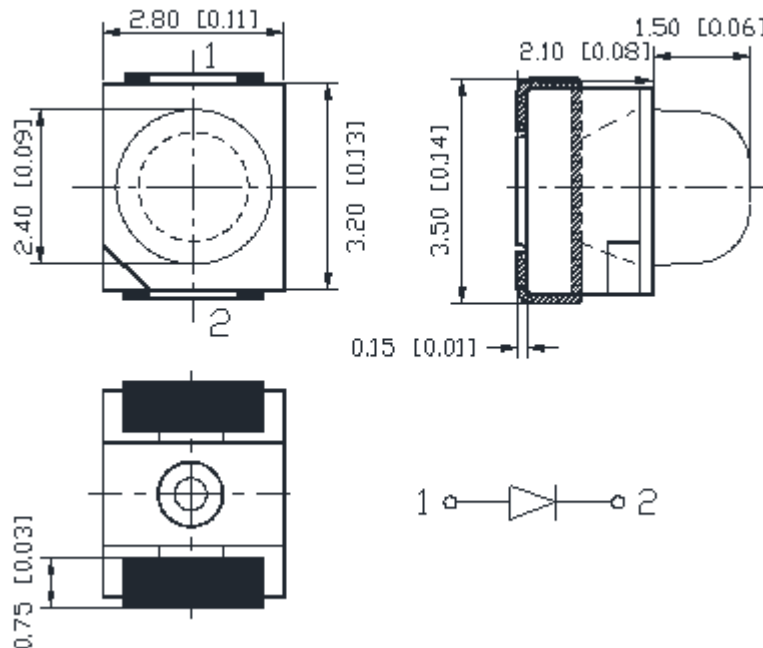

Units: mm / tolerance = +/-0.2mm

Electrical / Optical Characteristic (Ta=25 °C)

| Product | Color | I _F (mA) | V _F (V) | | CIE Coordinates | I _v (mcd) | |
|---------------------|------------|---------------------|--------------------|------|--------------------|----------------------|------|
| | | | Typ. | Max. | Typ. | Min. | Typ. |
| QBLP670D-IW-CW-2897 | Cool White | 20 | 2.8 | 3.3 | X=0.3123, Y=0.3282 | 5500 | 8000 |
| | | | | | CCT: 6500K | | |

Absolute Maximum Rating

| Material | P _d (mW) | I _F (mA) | I _{FP} (mA)* | V _R (V) | T _{OP} (°C) | T _{ST} (°C) |
|----------|---------------------|---------------------|-----------------------|--------------------|----------------------|----------------------|
| InGaN | 99 | 30 | 125 | 5 | -40 ~+80 | -40 ~+85 |

*Duty 1/8 @ 1KHz

Forward Voltage V_F @ I_F=20mA

| Bin | Min. | Max. | Unit |
|-----|------|------|------|
| A | 2.8 | 3.0 | V |
| B | 3.0 | 3.2 | |
| C | 3.2 | 3.4 | |

Luminous Intensity I_v @ I_F=20mA

| Bin | Min. | Max. | Unit |
|-----|------|-------|------|
| 1 | 5500 | 7000 | mcd |
| 2 | 7000 | 10000 | |

CIE Chromaticity Diagram

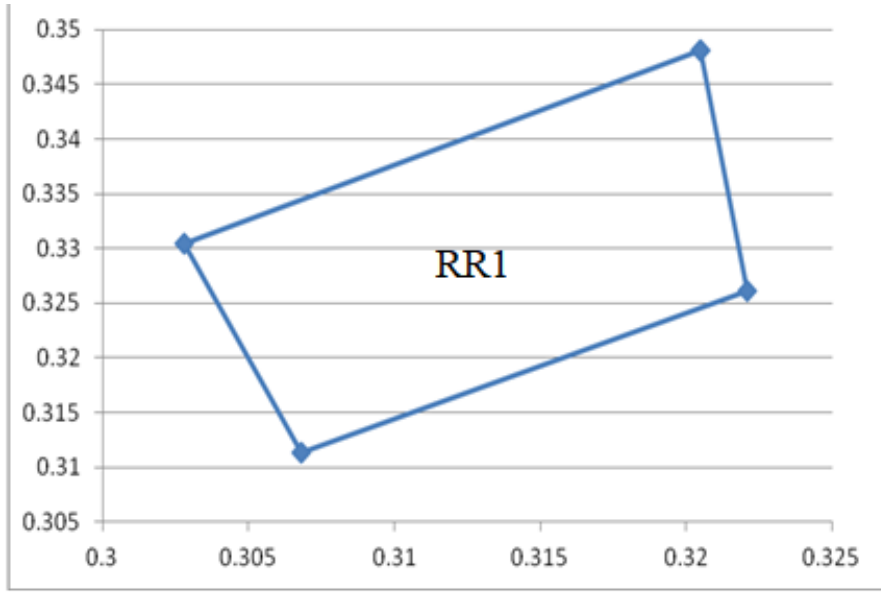

| | | | | | |
|-----|---|--------|--------|--------|--------|
| RR1 | X | 0.3205 | 0.3028 | 0.3068 | 0.3221 |
| | Y | 0.3481 | 0.3304 | 0.3113 | 0.3261 |

Characteristic Curves

InGaN

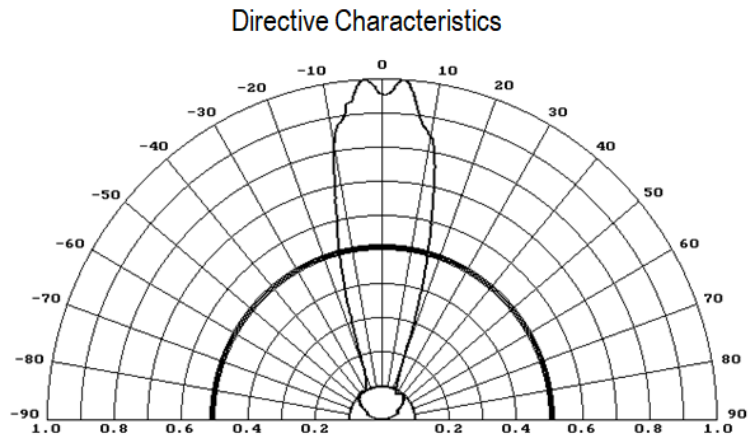
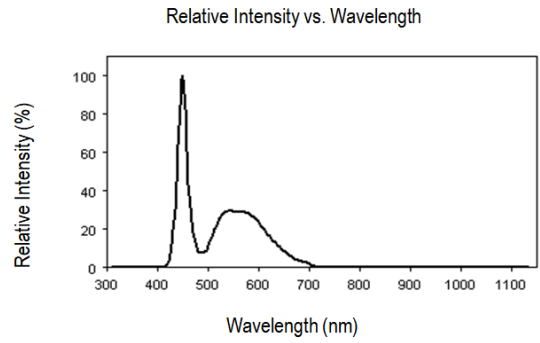
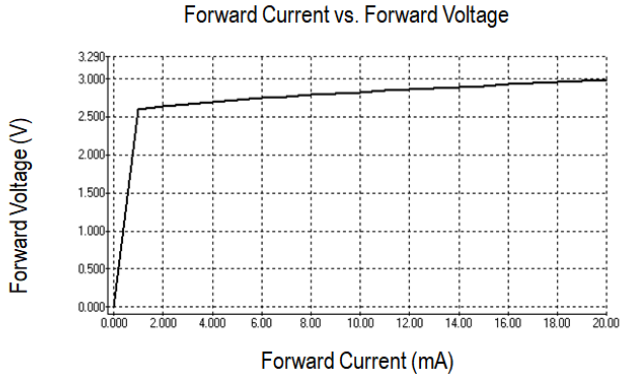

Solder Profile & Footprint

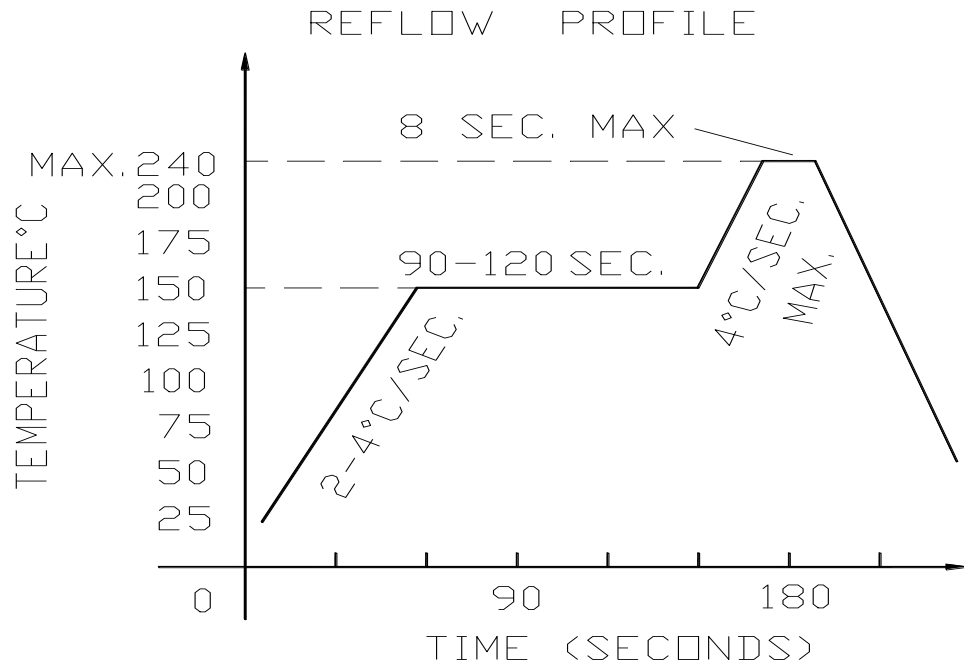

Recommended Pad Layout

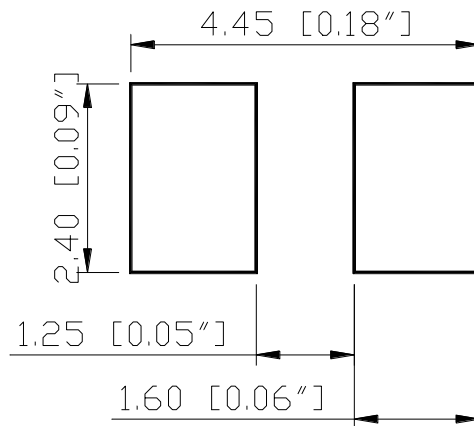

Units: mm

Tolerance: $\pm 0.2\text{mm}$

Recommended Handling Precautions

1. It is recommended to store the products in sealed and anti-static bags with desiccant inside at the following condition:
 - Humidity: <60% RH
 - Temperature: 5°C~30°C
2. Shelf life in sealed bag: 12 month at 5°C~30°C and < 60% R.H
3. After the package is opened:
 - 3.1 The products should be used within a week (168 hours)
 - 3.2 Or product should be stored at $\leq 20\%$ RH and (5°C~30°C) with zip-lock sealed bag
 - 3.3 It is recommended to bake before soldering when the package is unsealed after 72hrs;
 - 3.3.1 Baking condition (Tape and Reel Type): $60\pm 3^\circ\text{C}$ (24~36 hrs) and < 5% RH
 - 3.4 Products require baking before soldering/mounting if **3.1** or **3.2** is not met. Baking condition refers to **3.3.1**
4. If the product is not used within 3 months since manufacturing date, it is recommended to bake for 24 hrs @ 60°C before use.
5. If the product is not used after 3 months since manufacturing date, it is recommended to bake for 36~48 hrs @ 60°C before use.

| | | |
|------------------------------|----------------------|--------------|
| Product: QBLP670D-IW-CW-2897 | Date: March 17, 2021 | Page 8 of 11 |
| | Version# 1.0 | |



Ordering Information

| Part # | Orderable Part # | Spec Range | Quantity per Reel |
|---------------------|---------------------|------------------------------------------------------------------------|-------------------|
| QBLP670D-IW-CW-2897 | QBLP670D-IW-CW-2897 | Iv=8000mcd typ. @ If=20mA / CIE Coordinates: (X=0.3123, Y=0.3282) typ. | 2,000 units |

Revision History

| Description: | Revision # | Revision Date |
|------------------------------------|------------|---------------|
| New Release of QBLP670D-IW-CW-2897 | V1.0 | 03/17/2021 |
| | | |
| | | |
| | | |
| | | |

Disclaimer

QT-BRIGHTTEK reserves the right to make changes without further notice to any products herein to improve reliability, function or design. QT-BRIGHTTEK does not assume any liability arising out of the application or use of any product or circuit described herein; neither does it convey any license under its patent rights, nor the rights of others.

Life Support Policy

QT-BRIGHTTEK's products are not authorized for use as critical components in life support devices or systems without the express written approval of QT-BRIGHTTEK. As used herein:

1. Life support devices or systems are devices or systems which, (a) are intended for surgical implant into the body, or (b) support or sustain life, and (c) whose failure to perform when properly used in accordance with instructions for use provided in the labeling, can be reasonably expected to result in a significant injury of the user.
2. A critical component in any component of a life support device or system whose failure to perform can be reasonably expected to cause the failure of the life support device or system, or to affect its safety or effectiveness.