

DO NOT SCALE FROM THIS PRINT

TABLE 1			
ITEM	COMPONENT	-HF	-GF
1	SHELL	MMCXV-P-P-F-ST-SHL	
2	INSULATOR	MMCXV-P-P-ST-TH1-INS	
3	PIN	MMCXV-P-P-H-ST-TH1-PIN	MMCXV-P-P-G-ST-TH1-PIN

SERIES
-V: HIGH VIBRATION 50 OHM

GENDER
-P: PLUG

TYPE
-P: PCB

TERMINATION
-TH1: THROUGH HOLE

ORIENTATION
-ST: STRAIGHT

PLATING SPECIFICATION
-HF: 30µ" GOLD CENTER CONTACT, 3µ" GOLD OUTER CONTACT
-GF: 10µ" GOLD CENTER CONTACT, 3µ" GOLD OUTER CONTACT, 100µ" NICKEL FOR BODY (SEE TABLE 1)

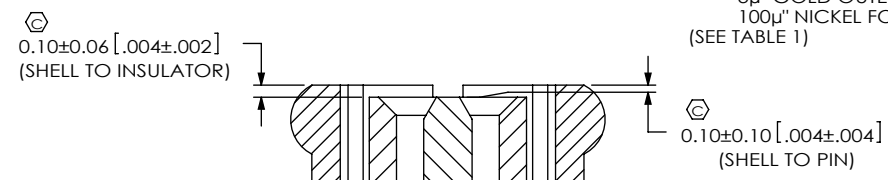
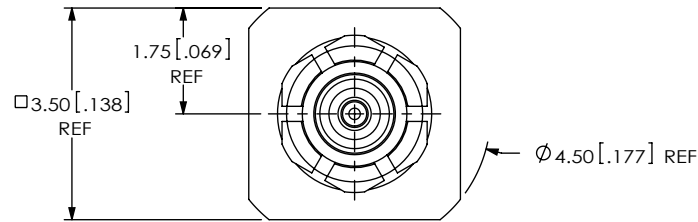

DETAIL 'B'
SCALE 16:1

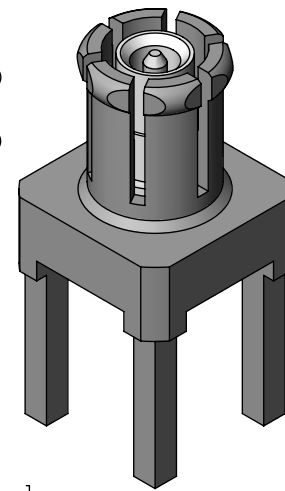
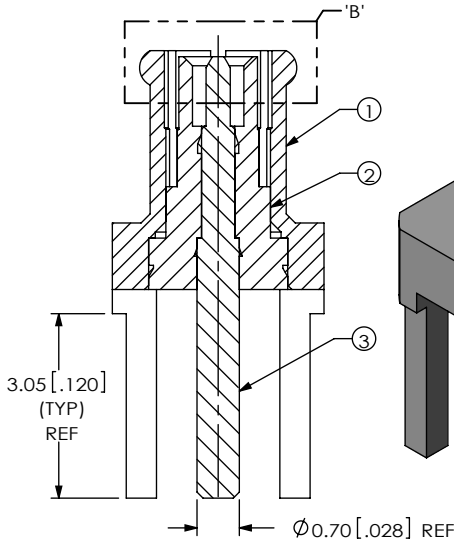
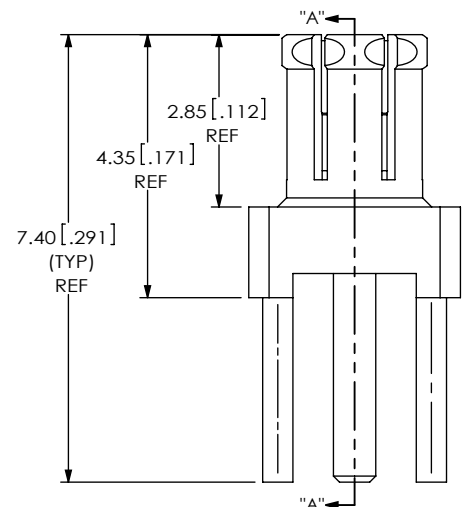

SECTION "A"-"A"

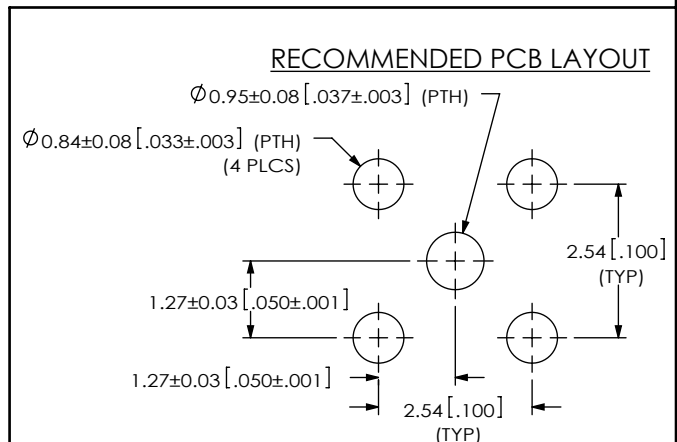
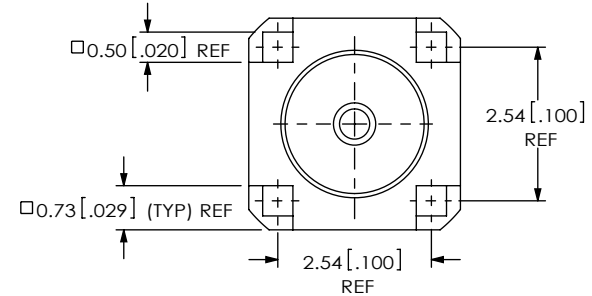

- NOTES:
- ⊕ REPRESENTS A CRITICAL DIMENSION.
 - MINIMUM PUSHOUT FORCE FOR INSULATOR: 22.24N [5.0 LBS].
 - MINIMUM PUSHOUT FORCE FOR CENTER CONTACT: 11.12N [2.5 LBS].
 - PRODUCT TO BE PACKAGED PER PACKING STANDARD CO-HD-WI-3040-M.
TRAY: TY-SMA001-1
COVER: TY-SMA001-2
200 PARTS PER TRAY (2 PARTS PER POCKET)

<p>UNLESS OTHERWISE SPECIFIED, DIMENSIONS ARE IN MILLIMETERS [INCHES]. TOLERANCES ARE:</p> <p>DECIMALS ANGLES X.X: ±0.3 [0.1] 5° X.XX: ±0.13 [0.005] X.XXX: ±0.051 [0.0020]</p>	<p>PROPRIETARY NOTE THIS DOCUMENT CONTAINS INFORMATION CONFIDENTIAL AND PROPRIETARY TO SAMTEC, INC. AND SHALL NOT BE REPRODUCED OR TRANSFERRED TO OTHER DOCUMENTS OR DISCLOSED TO OTHERS OR USED FOR ANY PURPOSE OTHER THAN THAT WHICH IT WAS OBTAINED WITHOUT THE EXPRESSED WRITTEN CONSENT OF SAMTEC, INC.</p>	<p>520 PARK EAST BLVD, NEW ALBANY, IN 47150 PHONE: 812-944-6733 FAX: 812-948-5047 e-Mail: info@SAMTEC.com code: 55322</p>

REVISION A

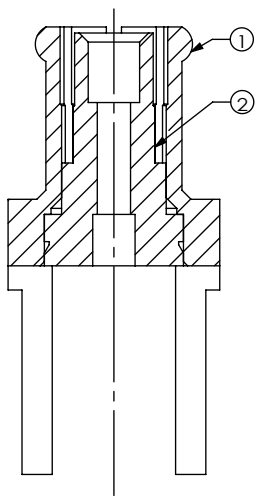

IN PROCESS 1
INSERT INSULATOR

PROPRIETARY NOTE

THIS DOCUMENT CONTAINS INFORMATION
CONFIDENTIAL AND PROPRIETARY TO
SAMTEC, INC. AND SHALL NOT BE REPRODUCED
OR TRANSFERRED TO OTHER DOCUMENTS OR
DISCLOSED TO OTHERS OR USED FOR ANY
PURPOSE OTHER THAN THAT WHICH IT WAS
OBTAINED WITHOUT THE EXPRESSED WRITTEN
CONSENT OF SAMTEC, INC.

DO NOT SCALE DRAWING

SHEET SCALE: 8:1

samtec

520 PARK EAST BLVD, NEW ALBANY, IN 47150
PHONE: 812-944-6733 FAX: 812-948-5047
e-Mail: info@SAMTEC.com code: 55322

DESCRIPTION:
MMCXV ST THROUGH HOLE, PLUG, HIGH VIBRATION 50 OHM

DWG. NO.
MMCXV-P-P-XX-ST-TH1

BY: ALVINW 11/20/2012 SHEET 2 OF 2