

# OSRAM KRTBDWLM32.32

## Datasheet

Not released

Published by **ams-OSRAM AG**

Tobelbader Strasse 30, 8141 Premstaetten, Austria

Phone +43 3136 500-0

[ams-osram.com](http://ams-osram.com)

© All rights reserved



## OSIRE® E3323

# KRTBDWLM32.32

The OSIRE E3323 is designed for automotive ambient applications. With its compact size, the device offers a maximum of flexibility for various assembly situations.

All measurement data of every single LED is made available at 10 and 50 mA via an imprinted data matrix code. This feature helps to reduce the optical measurement effort on customer side.



## Applications

- Ambient Lighting

## Features

- Package: white SMD package, colorless clear silicone resin
- Chip technology: Thinfilm / ThinGaN
- Color:  $\lambda_{\text{dom}} = 626.0 \text{ nm}$  (● red);  $\lambda_{\text{dom}} = 533.0 \text{ nm}$  (● true green);  $\lambda_{\text{dom}} = 462.0 \text{ nm}$  (● blue)
- Corrosion Robustness Class: 3B
- Qualifications: AEC-Q102 Qualified
- ESD: 2 kV acc. to ANSI/ESDA/JEDEC JS-001 (HBM, Class 2)
- Measurement data available via DMC
- Size of DMC: 1.6 x 0.4 mm
- Pixel size: 50  $\mu\text{m}$
- Access to look-up file provided by OS
- Data format: .csv
- Device ID linked to electro-optical test data
- White point calibration based on test data possible
- Test Data available at two setpoints (10 and 50 mA)

## Ordering Information

Type

Parameter	Brightness IF = 10 mA	Ordering Code
KRTBDWLM32.32-T4U6-JW+AAAB-J3+R4S6-5V		Q65112A7940
red	IV = 315 ... 800 mcd	
true green	IV = 1120 ... 1800 mcd	
blue	IV = 125 ... 320 mcd	

## Typical brightness

T<sub>s</sub> = 25°C

Color	Current in mA	Value	Unit
red	10	560	mcd
true green	10	1460	mcd
blue	10	220	mcd
red	50	2700	mcd
true green	50	4140	mcd
blue	50	720	mcd

Not released

## Maximum Ratings

Parameter	Symbol		Values	Values	Values
			● red	● true green	● blue
Operating Temperature	$T_{op}$	min.	-40 °C	-40 °C	-40 °C
		max.	110 °C	110 °C	110 °C
Storage Temperature	$T_{stg}$	min.	-40 °C	-40 °C	-40 °C
		max.	110 °C	110 °C	110 °C
Junction Temperature	$T_j$	max.	125 °C	125 °C	125 °C
Forward Current $T_s = 25\text{ °C}$	$I_F$	min.	1 mA	1 mA	1 mA
		max.	50 mA	50 mA	50 mA
Reverse voltage <sup>1)</sup> $T_s = 25\text{ °C}$	$V_R$	max.	12 V	5 V	5 V
ESD withstand voltage acc. to ANSI/ESDA/JEDEC JS-001 (HBM, Class 2)	$V_{ESD}$		2 kV	2 kV	2 kV

Not released

## Characteristics

$I_F = 10 \text{ mA}$ ;  $T_S = 25 \text{ °C}$

Parameter	Symbol		Values	Values	Values
			● red	● true green	● blue
Peak Wavelength	$\lambda_{\text{peak}}$	typ.	635.0 nm	526.0 nm	456.0 nm
Dominant Wavelength <sup>2)</sup>	$\lambda_{\text{dom}}$	min.	620.0 nm	524.0 nm	449.0 nm
		typ.	626.0 nm	533.0 nm	462.0 nm
		max.	632.0 nm	541.0 nm	473.0 nm
Forward Voltage <sup>3)</sup> $I_F = 10 \text{ mA}$	$V_F$	min.	1.80 V	2.30 V	2.50 V
		typ.	1.90 V	2.45 V	2.75 V
		max.	2.30 V	2.90 V	3.10 V
Reverse current <sup>1)</sup> $V_R = 5 \text{ V}$ (blue / true green); 12 V (red)	$I_R$	max.	10 $\mu\text{A}$	10 $\mu\text{A}$	10 $\mu\text{A}$
		typ.	0.01 $\mu\text{A}$	0.01 $\mu\text{A}$	0.01 $\mu\text{A}$
Real thermal resistance junction/solderpoint <sup>4)</sup>	$R_{\text{thJS real}}$	typ.	83 K / W	61 K / W	59 K / W
		max.	99 K / W	74 K / W	71 K / W

## Characteristics

$I_F = 50 \text{ mA}$ ;  $T_S = 25 \text{ °C}$

Parameter	Symbol		Values	Values	Values
			● red	● true green	● blue
Forward Voltage <sup>3)</sup> $I_F = 50 \text{ mA}$	$V_F$	min.	2,0 V	2,6 V	2,8 V
		max.	3,5 V	3,3 V	3,9 V

Not released

## Brightness Groups

- red

Group	Luminous Intensity <sup>5)</sup> $I_F = 10 \text{ mA}$ min. $I_v$	Luminous Intensity <sup>5)</sup> $I_F = 10 \text{ mA}$ max. $I_v$
T4	315 mcd	400 mcd
T2	355 mcd	450 mcd
T6	400 mcd	500 mcd
U1	450 mcd	560 mcd
U4	500 mcd	630 mcd
U2	560 mcd	710 mcd
U6	630 mcd	800 mcd

## Brightness Groups

- true green

Group	Luminous Intensity <sup>5)</sup> $I_F = 10 \text{ mA}$ min. $I_v$	Luminous Intensity <sup>5)</sup> $I_F = 10 \text{ mA}$ max. $I_v$
AA	1120 mcd	1400 mcd
A4	1250 mcd	1590 mcd
AB	1400 mcd	1800 mcd

Not released

## Brightness Groups

- blue

Group	Luminous Intensity <sup>5)</sup> $I_F = 10 \text{ mA}$ min. $I_v$	Luminous Intensity <sup>5)</sup> $I_F = 10 \text{ mA}$ max. $I_v$
R4	125 mcd	159 mcd
R2	140 mcd	180 mcd
R6	159 mcd	201 mcd
S1	180 mcd	224 mcd
S4	201 mcd	250 mcd
S2	224 mcd	280 mcd
S6	250 mcd	320 mcd

Not released

## Wavelength Groups

- red

Group	Dominant Wavelength <sup>2)</sup>	Dominant Wavelength <sup>2)</sup>
	min. $\lambda_{\text{dom}}$	max. $\lambda_{\text{dom}}$
JP	620.0 nm	625.0 nm
MT	623.0 nm	629.0 nm
RW	627.0 nm	632.0 nm

## Wavelength Groups

- true green

Group	Dominant Wavelength <sup>2)</sup>	Dominant Wavelength <sup>2)</sup>
	min. $\lambda_{\text{dom}}$	max. $\lambda_{\text{dom}}$
JP	524.0 nm	529.0 nm
LR	526.0 nm	531.0 nm
PU	529.0 nm	534.0 nm
RW	531.0 nm	536.0 nm
U3	534.0 nm	541.0 nm

## Wavelength Groups

- blue

Group	Dominant Wavelength <sup>2)</sup>	Dominant Wavelength <sup>2)</sup>
	min. $\lambda_{\text{dom}}$	max. $\lambda_{\text{dom}}$
51	449.0 nm	453.0 nm
3C	451.0 nm	456.0 nm
AF	454.0 nm	459.0 nm
DH	457.0 nm	461.0 nm
FK	459.0 nm	463.0 nm
HM	461.0 nm	465.0 nm
KP	463.0 nm	467.0 nm
MS	465.0 nm	470.0 nm
QV	468.0 nm	473.0 nm



## Chromaticity Coordinate Groups

● red

Group	Cx	Cy
JP	0.6879	0.3086
	0.6915	0.3083
	0.7006	0.2993
	0.6969	0.2996
MT	0.6936	0.3030
	0.6972	0.3027
	0.7066	0.2934
	0.7028	0.2938
RW	0.7000	0.2966
	0.7037	0.2962
	0.7105	0.2895
	0.7067	0.2899

## Chromaticity Coordinate Groups

● true green

Group	Cx	Cy
JP	0.1606	0.7102
	0.1415	0.7518
	0.1679	0.7565
	0.1831	0.7174
LR	0.1694	0.7136
	0.1517	0.7547
	0.1794	0.7549
	0.1933	0.7170
PU	0.1831	0.7174
	0.1678	0.7565
	0.1973	0.7500
	0.2091	0.7142
RW	0.1932	0.7170
	0.1794	0.7549
	0.2098	0.7449
	0.2196	0.7122

## Chromaticity Coordinate Groups

- true green

Group	Cx	Cy
U3	0.2091	0.7142
	0.1974	0.7500
	0.2419	0.7273
	0.2474	0.7029

## Chromaticity Coordinate Groups

- blue

Group	Cx	Cy
3C	0.1588	0.0243
	0.1556	0.0186
	0.1500	0.0246
	0.1543	0.0317
51	0.1606	0.0222
	0.1576	0.0168
	0.1534	0.0206
	0.1570	0.0268
AF	0.1562	0.0285
	0.1524	0.0219
	0.1462	0.0293
	0.1509	0.0370
DH	0.1532	0.0332
	0.1489	0.0262
	0.1436	0.0332
	0.1487	0.0414
FK	0.1509	0.0370
	0.1462	0.0293
	0.1407	0.0376
	0.1463	0.0463
HM	0.1487	0.0414
	0.1436	0.0332
	0.1375	0.0428
	0.1436	0.0519

## Chromaticity Coordinate Groups

- blue

Group	Cx	Cy
KP	0.1463	0.0463
	0.1407	0.0376
	0.1338	0.0493
	0.1404	0.0588
MS	0.1436	0.0519
	0.1375	0.0428
	0.1272	0.0620
	0.1354	0.0727
QV	0.1389	0.0631
	0.1317	0.0532
	0.1199	0.0785
	0.1295	0.0899

Not released

### Relative Spectral Emission <sup>6)</sup>

$I_{rel} = f(\lambda); I_F = 10 \text{ mA}; T_S = 25 \text{ }^\circ\text{C}$

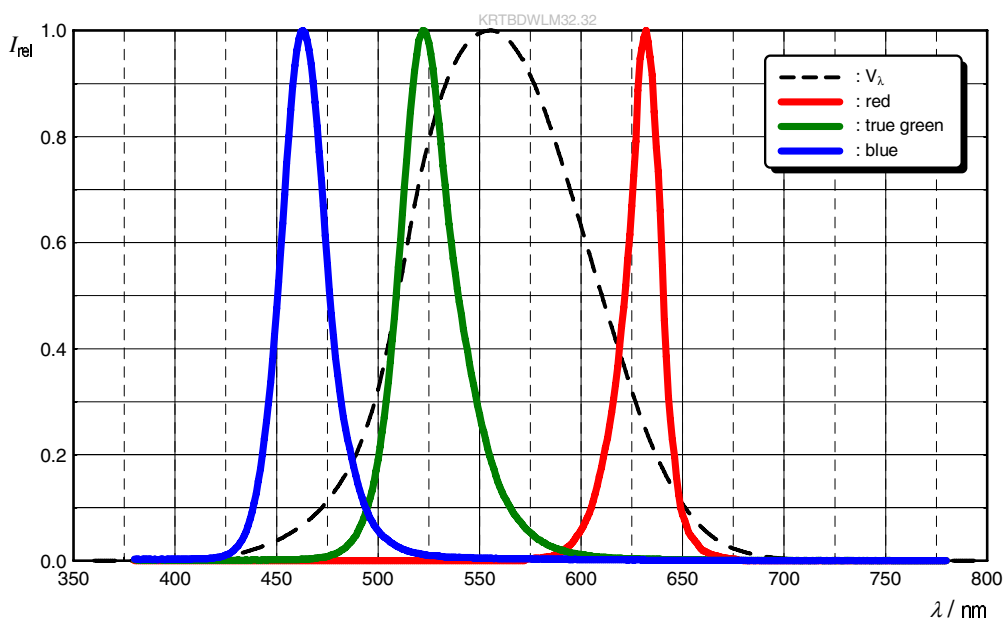

### Radiation Characteristics <sup>6)</sup>

$I_{rel} = f(\phi); T_S = 25 \text{ }^\circ\text{C}$

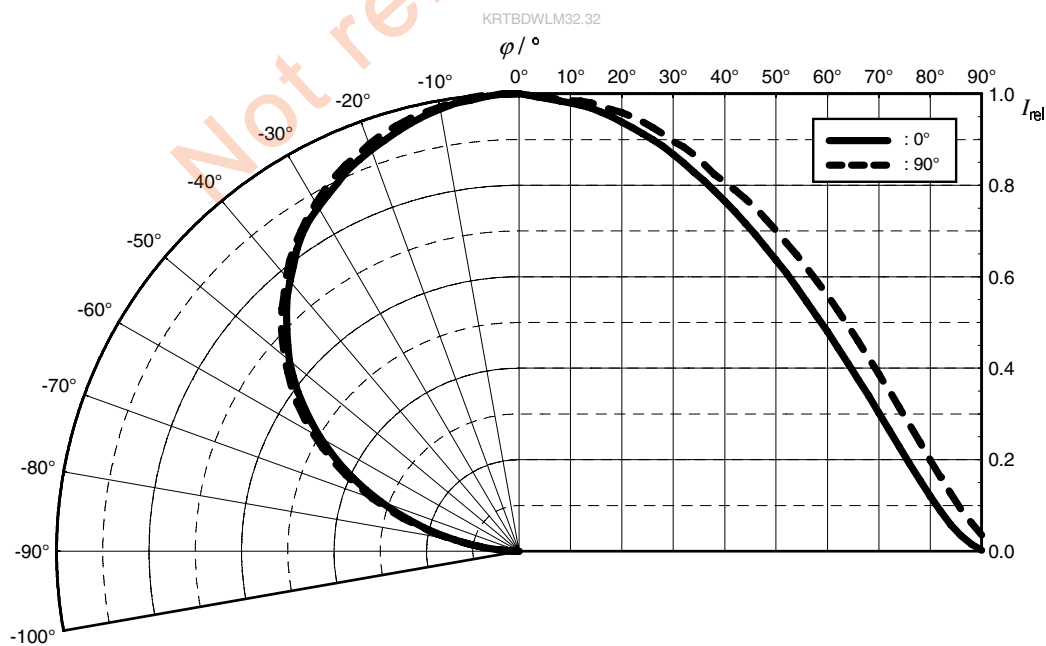

**Forward current** <sup>6)</sup>

$I_F = f(V_F); T_S = 25\text{ °C}$

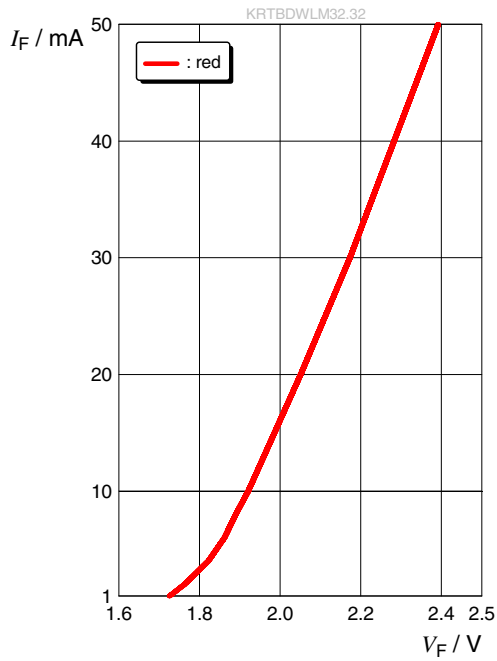

**Forward current** <sup>6)</sup>

$I_F = f(V_F); T_S = 25\text{ °C}$

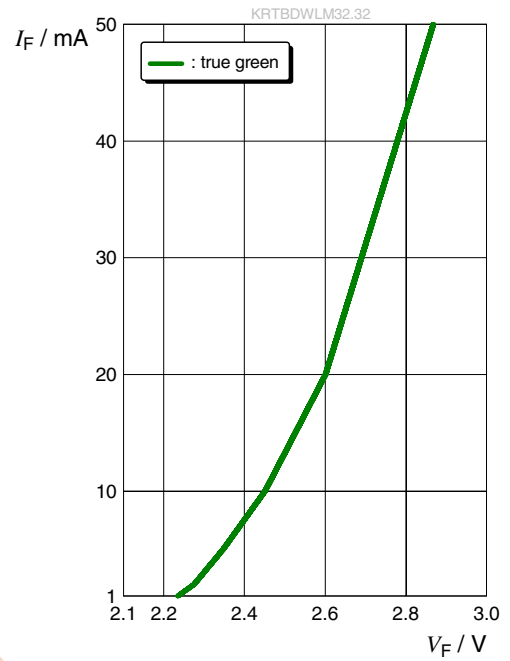

**Forward current** <sup>6)</sup>

$I_F = f(V_F); T_S = 25\text{ °C}$

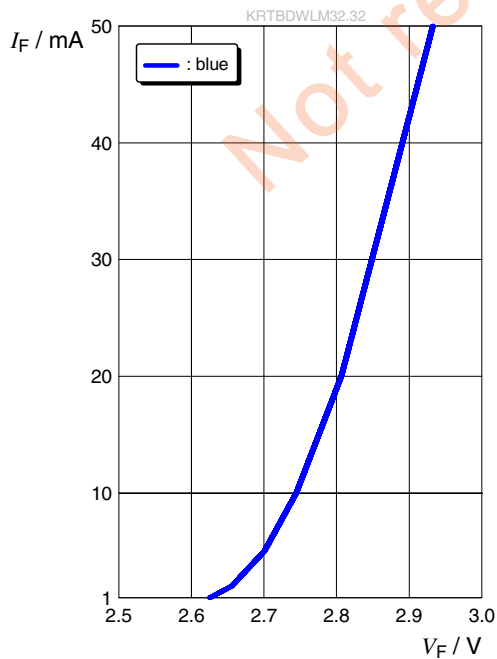

Not released

**Relative Luminous Intensity** 6), 7)

$I_V/I_V(10\text{ mA}) = f(I_F); T_s = 25\text{ °C}$

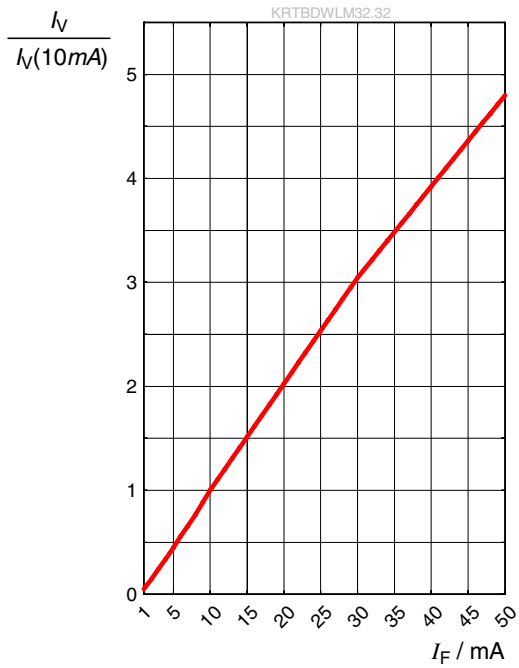

**Relative Luminous Intensity** 6), 7)

$I_V/I_V(10\text{ mA}) = f(I_F); T_s = 25\text{ °C}$

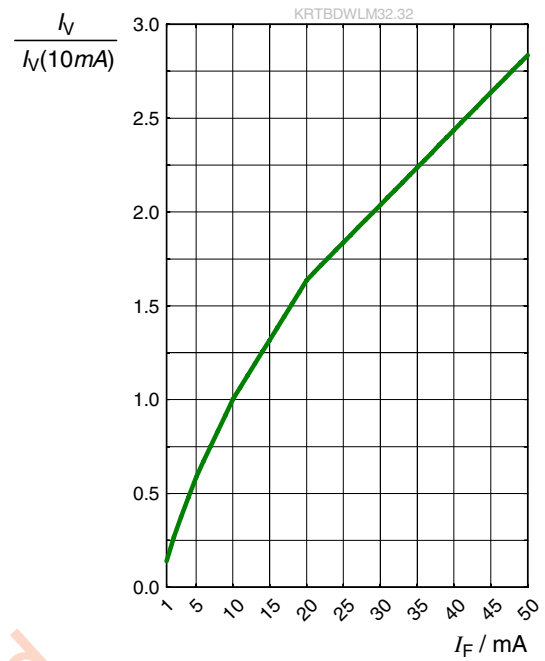

**Relative Luminous Intensity** 6), 7)

$I_V/I_V(10\text{ mA}) = f(I_F); T_s = 25\text{ °C}$

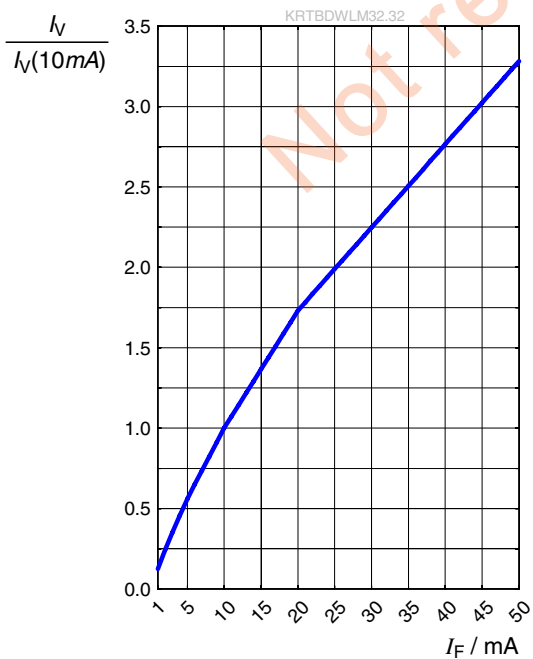

Not released

### Dominant Wavelength <sup>6)</sup>

$$\Delta\lambda_{\text{dom}} = f(I_F); T_S = 25\text{ °C}$$

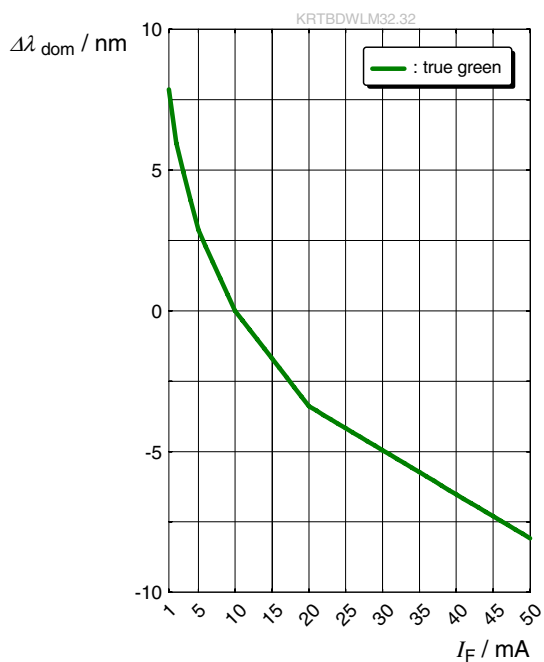

### Dominant Wavelength <sup>6)</sup>

$$\Delta\lambda_{\text{dom}} = f(I_F); T_S = 25\text{ °C}$$

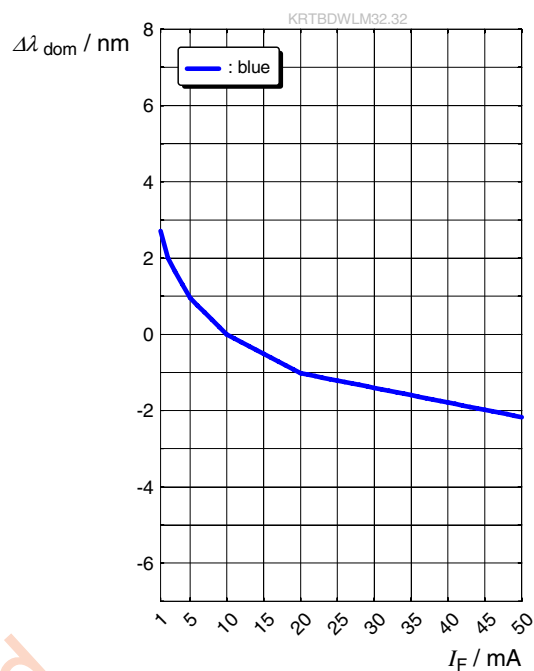

Not released

### Forward Voltage <sup>6)</sup>

$$\Delta V_F = V_F - V_F(25\text{ °C}) = f(T_j); I_F = 10\text{ mA}$$

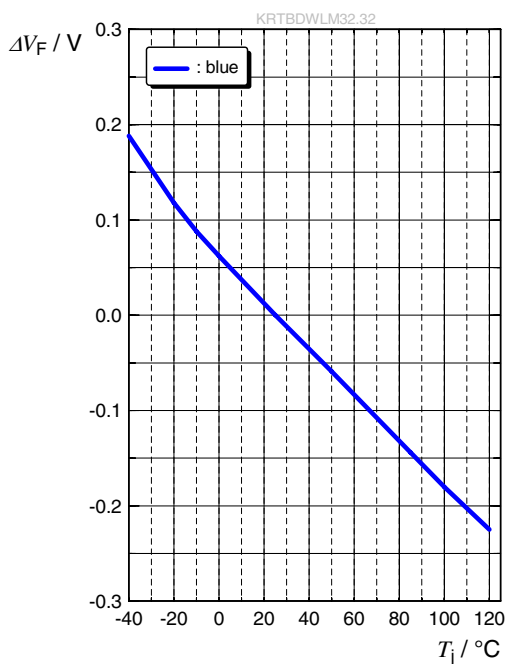

### Forward Voltage <sup>6)</sup>

$$\Delta V_F = V_F - V_F(25\text{ °C}) = f(T_j); I_F = 10\text{ mA}$$

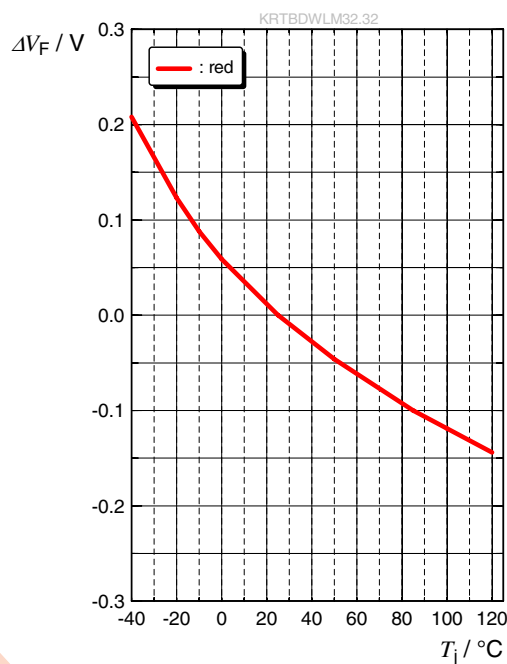

### Forward Voltage <sup>6)</sup>

$$\Delta V_F = V_F - V_F(25\text{ °C}) = f(T_j); I_F = 10\text{ mA}$$

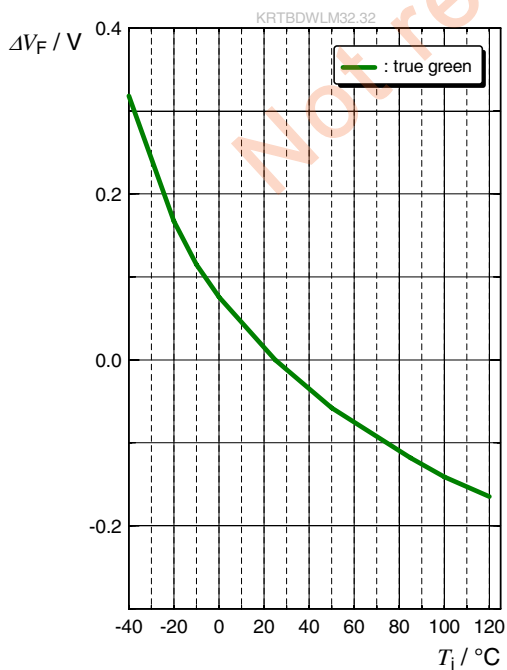

Not released



### Relative Luminous Intensity <sup>6)</sup>

$$I_V/I_V(25\text{ °C}) = f(T_j); I_F = 10\text{ mA}$$

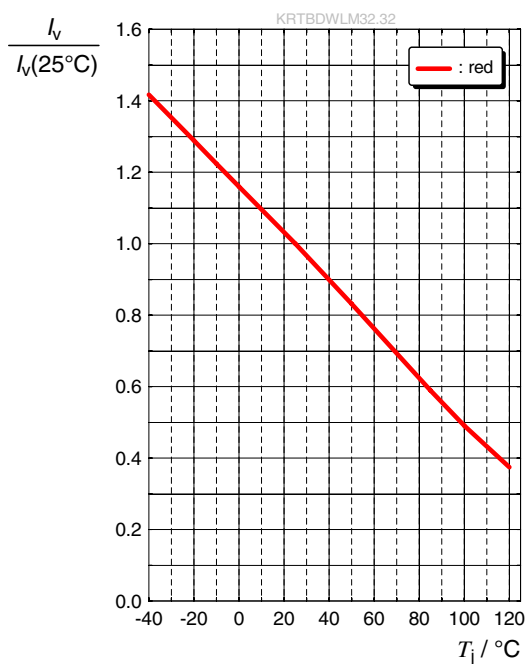

### Relative Luminous Intensity <sup>6)</sup>

$$I_V/I_V(25\text{ °C}) = f(T_j); I_F = 10\text{ mA}$$

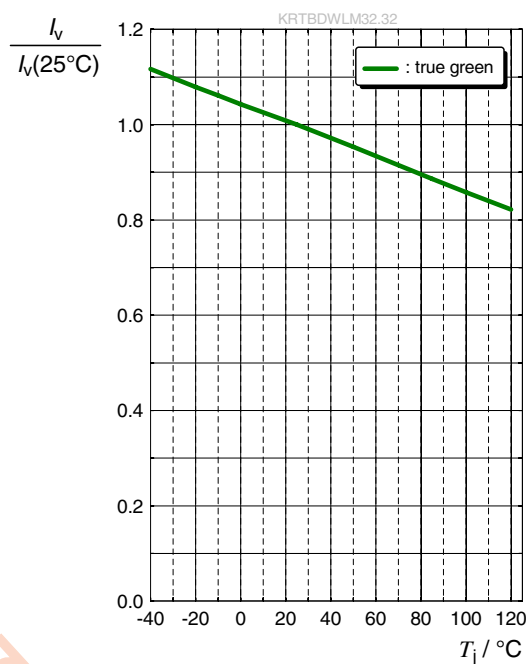

### Relative Luminous Intensity <sup>6)</sup>

$$I_V/I_V(25\text{ °C}) = f(T_j); I_F = 10\text{ mA}$$

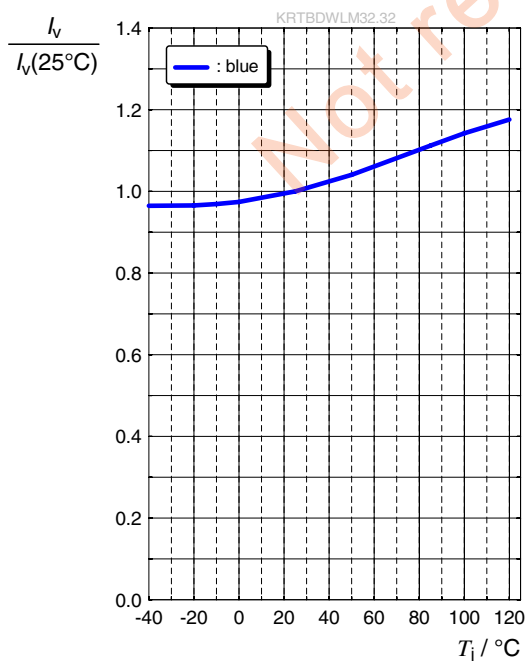

Not released

### Dominant Wavelength <sup>6)</sup>

$$\Delta\lambda_{\text{dom}} = \lambda_{\text{dom}} - \lambda_{\text{dom}}(25\text{ °C}) = f(T_j); I_F = 10\text{ mA}$$

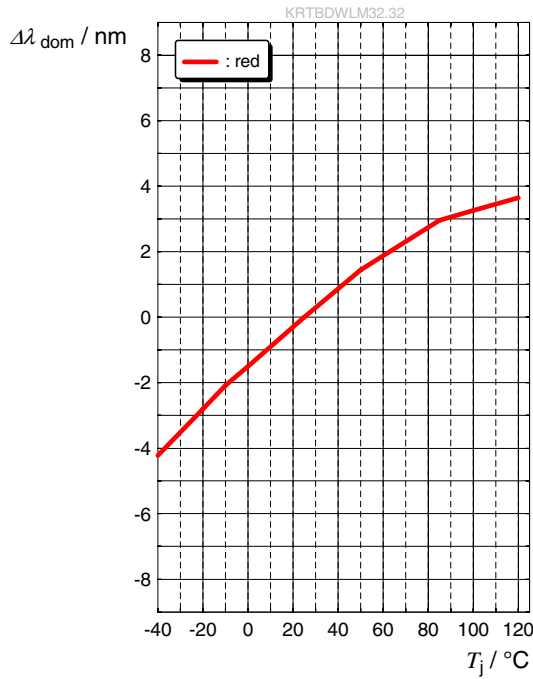

### Dominant Wavelength <sup>6)</sup>

$$\Delta\lambda_{\text{dom}} = \lambda_{\text{dom}} - \lambda_{\text{dom}}(25\text{ °C}) = f(T_j); I_F = 10\text{ mA}$$

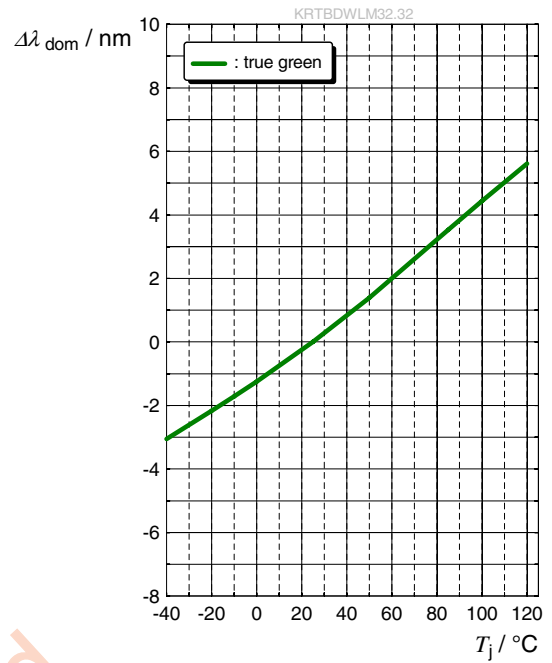

### Dominant Wavelength <sup>6)</sup>

$$\Delta\lambda_{\text{dom}} = \lambda_{\text{dom}} - \lambda_{\text{dom}}(25\text{ °C}) = f(T_j); I_F = 10\text{ mA}$$

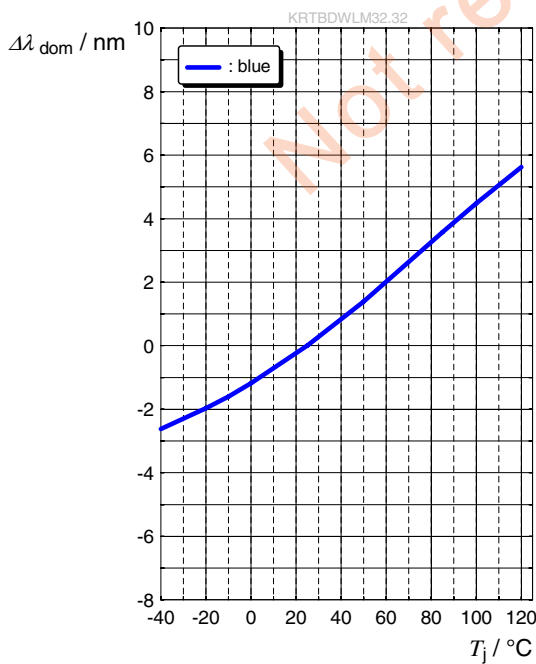

### Max. Permissible Forward Current

$I_F = f(T)$ ; ● red

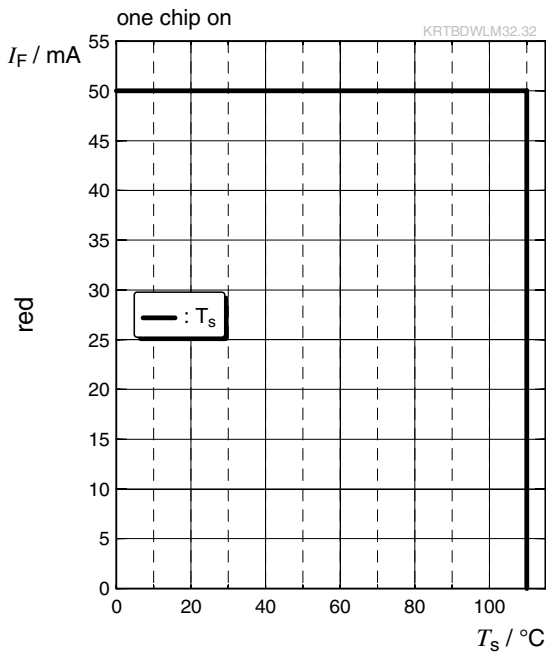

### Max. Permissible Forward Current

$I_F = f(T)$ ; ● true green

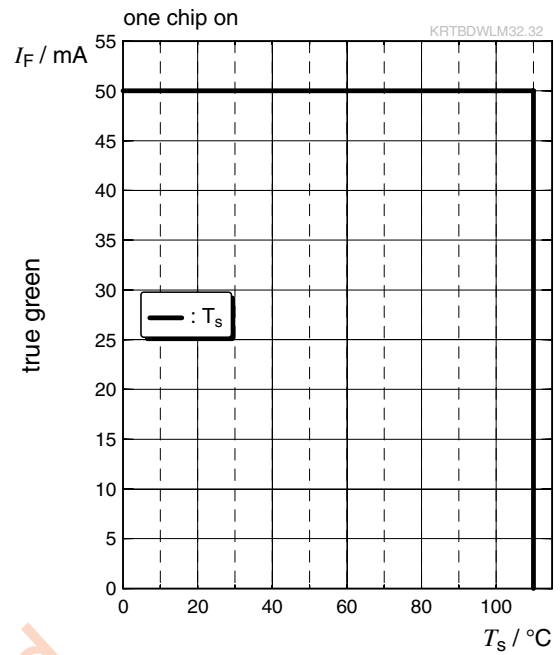

### Max. Permissible Forward Current

$I_F = f(T)$ ; ● blue

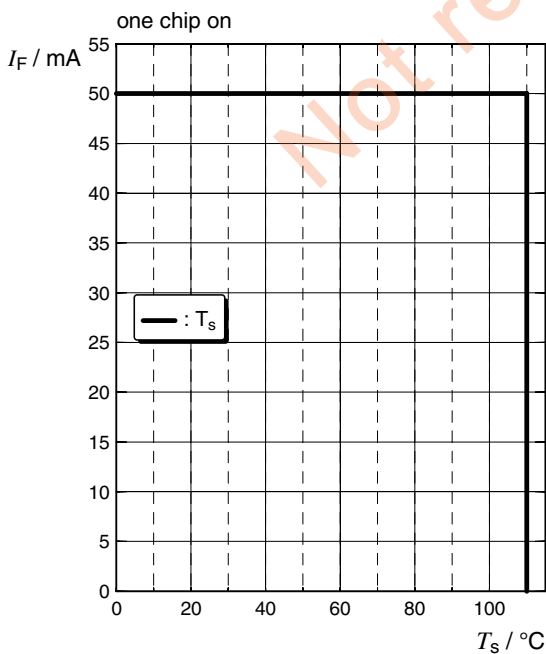

Not released

Dimensional Drawing <sup>8)</sup>

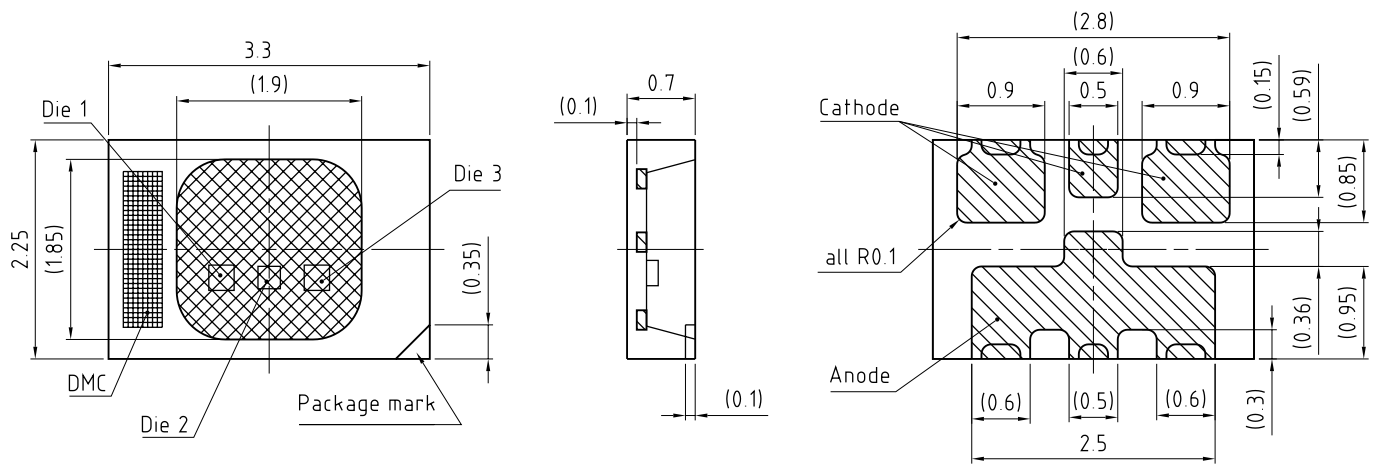

C67062-A0273-A1..-09

Further Information:

Approximate Weight: 16.0 mg

Corrosion test: Class: 3B  
Test condition: 40°C / 90 % RH / 15 ppm H<sub>2</sub>S / 14 days (stricter than IEC 60068-2-43)

Not released

Electrical Internal Circuit

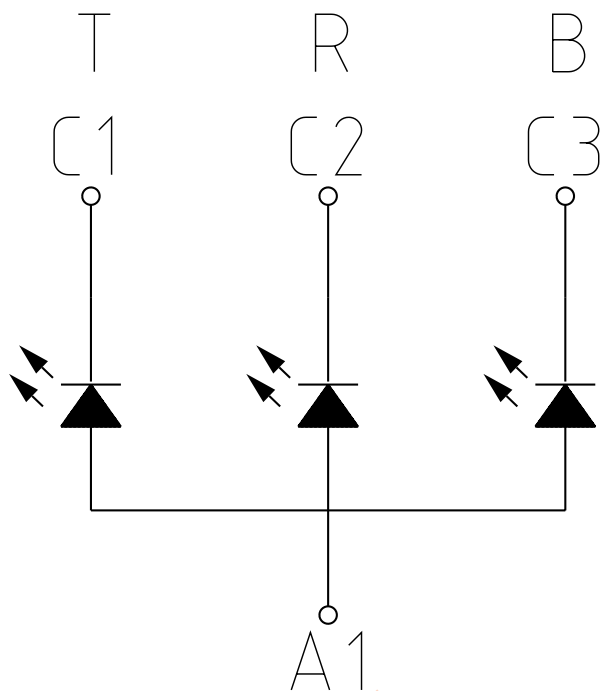

Not released

Recommended Solder Pad <sup>8)</sup>

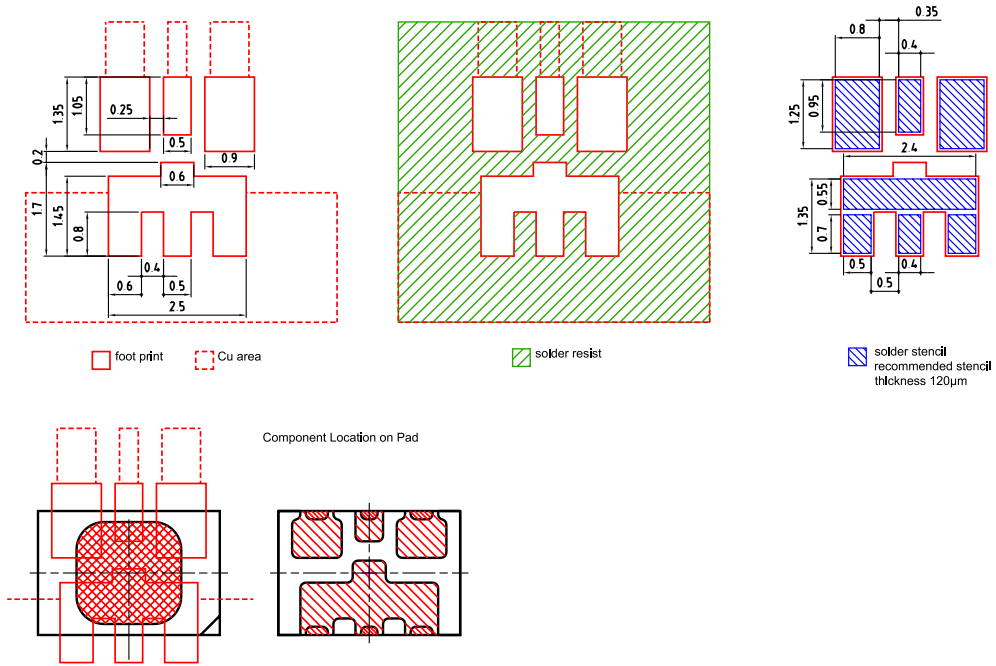

E062.3010.245 -02

For superior solder joint connectivity results we recommend soldering under standard nitrogen atmosphere. Package not suitable for any kind of wet cleaning or ultrasonic cleaning.

Not released

### Reflow Soldering Profile

Product complies to MSL Level 2 acc. to JEDEC J-STD-020E

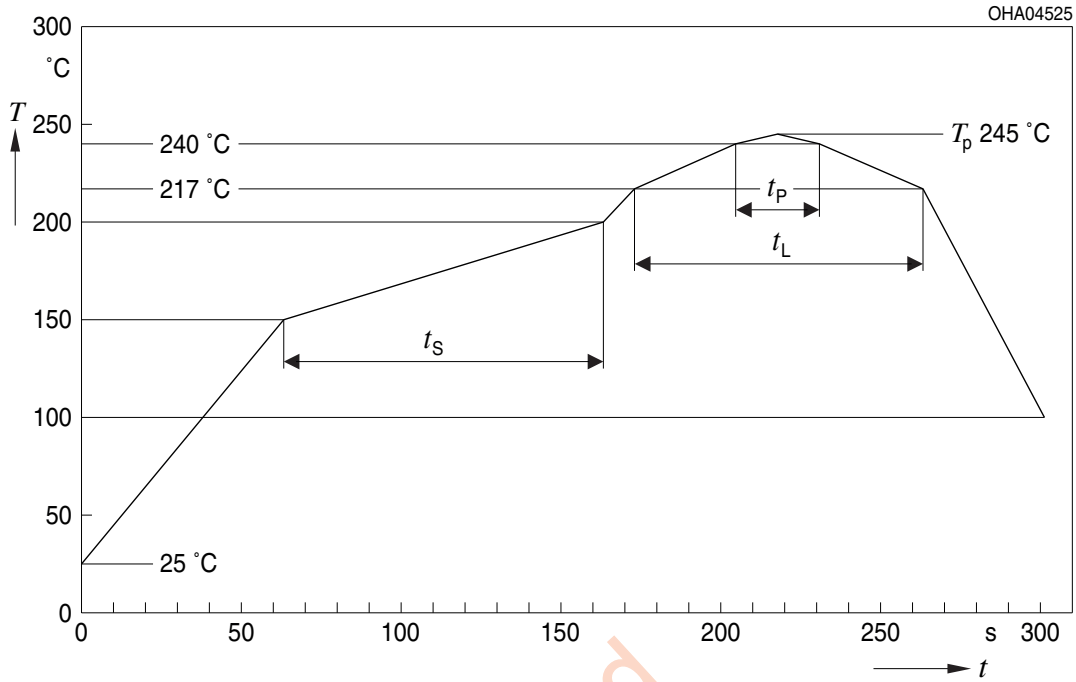

Profile Feature	Symbol	Pb-Free (SnAgCu) Assembly			Unit
		Minimum	Recommendation	Maximum	
Ramp-up rate to preheat <sup>*)</sup> 25 °C to 150 °C			2	3	K/s
Time $t_s$ $T_{Smin}$ to $T_{Smax}$	$t_s$	60	100	120	s
Ramp-up rate to peak <sup>*)</sup> $T_{Smax}$ to $T_p$			2	3	K/s
Liquidus temperature	$T_L$		217		°C
Time above liquidus temperature	$t_L$		80	100	s
Peak temperature	$T_p$		245	260	°C
Time within 5 °C of the specified peak temperature $T_p - 5$ K	$t_p$	10	20	30	s
Ramp-down rate* $T_p$ to 100 °C			3	6	K/s
Time 25 °C to $T_p$				480	s

All temperatures refer to the center of the package, measured on the top of the component  
 \*) slope calculation  $DT/Dt$ :  $Dt$  max. 5 s; fulfillment for the whole T-range

Taping <sup>8)</sup>

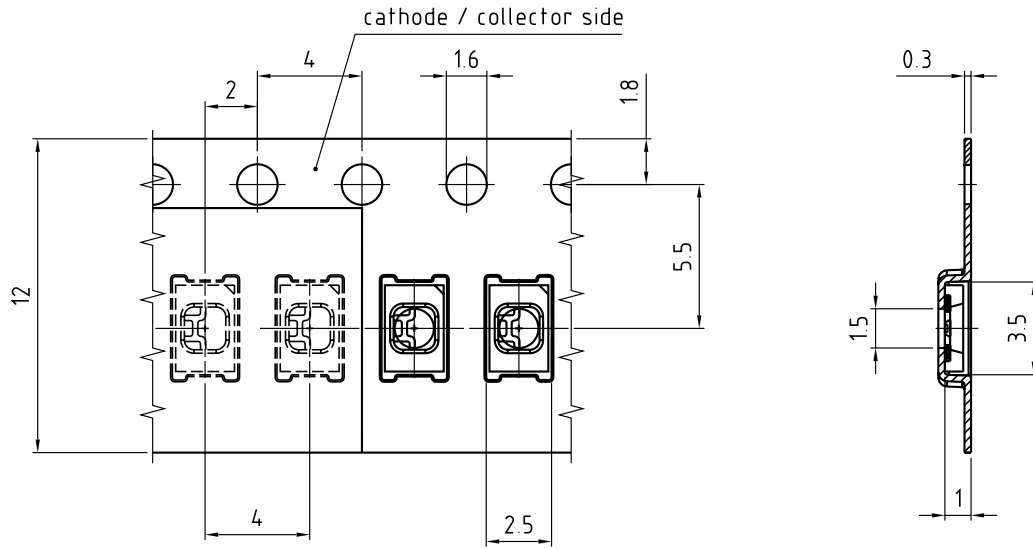

C67062-A0273-B5-01

Not released



**Tape and Reel** <sup>9)</sup>

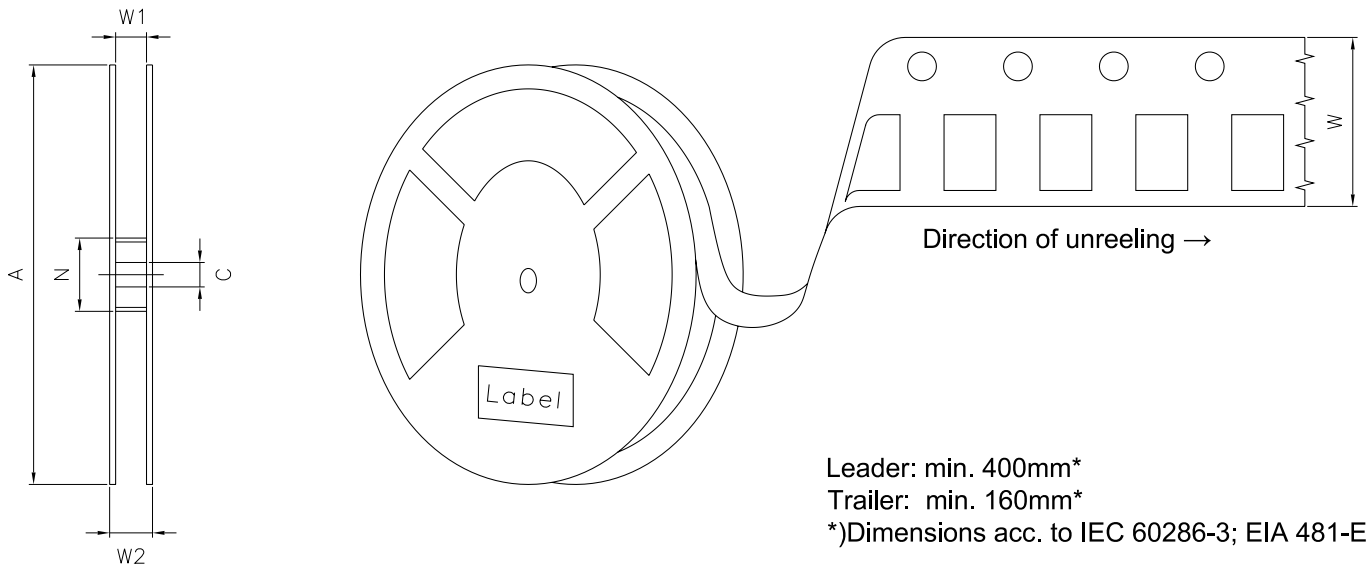

**Reel Dimensions**

A	W	N <sub>min</sub>	W <sub>1</sub>	W <sub>2max</sub>	Pieces per PU
180 mm	12 + 0.3 / - 0.1 mm	60 mm	12.4 + 2 mm	18.4 mm	2000

Not released

**Barcode-Product-Label (BPL)**

**OSRAM Opto Semiconductors** LX XXXX    BIN1: XX-XX-X-XXX-X



RoHS Compliant

(6P) BATCH NO: 1234567890 ML Temp    ST  
X    XXX °C X

(1T) LOT NO: 1234567890 (9D) D/C: 1234

(X) PROD NO: 123456789(Q)QTY: 9999 (G) GROUP: XX-XX-X-X

Pack: RXX  
DEMY    XXX  
X\_X123\_1234.1234 X

OHA04563

**Dry Packing Process and Materials <sup>8)</sup>**

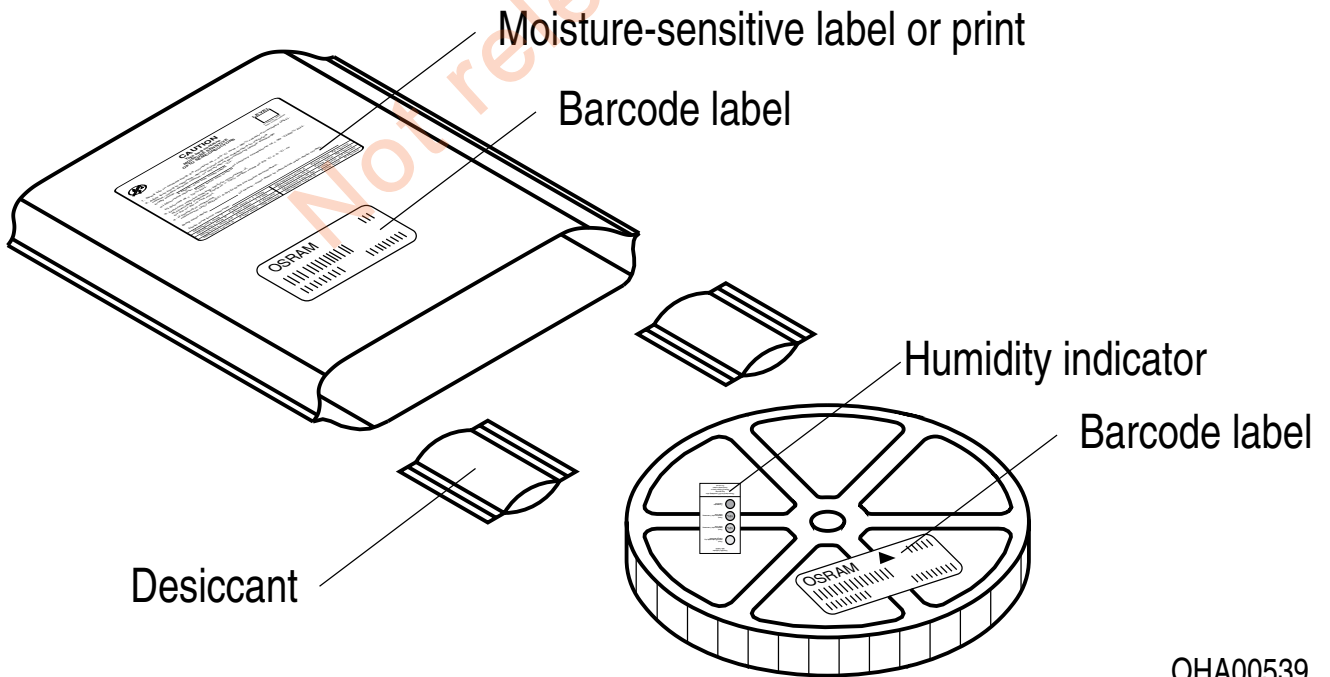

OHA00539

Moisture-sensitive product is packed in a dry bag containing desiccant and a humidity card according JEDEC-STD-033.

---

## Notes

The evaluation of eye safety occurs according to the standard IEC 62471:2006 (photo biological safety of lamps and lamp systems). Within the risk grouping system of this IEC standard, the device specified in this data sheet fall into the class **exempt group (exposure time 10000 s)**. Under real circumstances (for exposure time, conditions of the eye pupils, observation distance), it is assumed that no endangerment to the eye exists from these devices. As a matter of principle, however, it should be mentioned that intense light sources have a high secondary exposure potential due to their blinding effect. When looking at bright light sources (e.g. headlights), temporary reduction in visual acuity and afterimages can occur, leading to irritation, annoyance, visual impairment, and even accidents, depending on the situation.

Subcomponents of this device contain, in addition to other substances, metal filled materials including silver. Metal filled materials can be affected by environments that contain traces of aggressive substances. Therefore, we recommend that customers minimize device exposure to aggressive substances during storage, production, and use. Devices that showed visible discoloration when tested using the described tests above did show no performance deviations within failure limits during the stated test duration. Respective failure limits are described in the IEC60810.

For further application related information please visit [www.osram-os.com/appnotes](http://www.osram-os.com/appnotes)

Not released

---

## Disclaimer

### Attention please!

The information describes the type of component and shall not be considered as assured characteristics. Terms of delivery and rights to change design reserved. Due to technical requirements components may contain dangerous substances.

For information on the types in question please contact our Sales Organization.

If printed or downloaded, please find the latest version on our website.

### Packing

Please use the recycling operators known to you. We can also help you – get in touch with your nearest sales office. By agreement we will take packing material back, if it is sorted. You must bear the costs of transport. For packing material that is returned to us unsorted or which we are not obliged to accept, we shall have to invoice you for any costs incurred.

### Product and functional safety devices/applications or medical devices/applications

Our components are not developed, constructed or tested for the application as safety relevant component or for the application in medical devices.

Our products are not qualified at module and system level for such application.

In case buyer – or customer supplied by buyer – considers using our components in product safety devices/ applications or medical devices/applications, buyer and/or customer has to inform our local sales partner immediately and we and buyer and /or customer will analyze and coordinate the customer-specific request between us and buyer and/or customer.

Not released

## Glossary

- 1) **Reverse Operation:** This product is intended to be operated applying a forward current within the specified range. Applying any continuous reverse bias or forward bias below the voltage range of light emission shall be avoided because it may cause migration which can change the electro-optical characteristics or damage the LED.
- 2) **Wavelength:** The wavelength is measured at a current pulse of typically 25 ms, with an internal reproducibility of  $\pm 0.5$  nm and an expanded uncertainty of  $\pm 1$  nm (acc. to GUM with a coverage factor of  $k = 3$ ).
- 3) **Forward Voltage:** Forward voltages are tested at a current pulse duration of 1 ms and a tolerance of  $\pm 0.05$  V and an expanded uncertainty of  $\pm 0.1$  V (acc. to GUM with a coverage factor of  $k = 3$ ).
- 4) **Thermal Resistance:**  $R_{th\ max}$  is based on statistic values ( $6\sigma$ ).
- 5) **Brightness:** Brightness values are measured during a current pulse of typically 25 ms, with an internal reproducibility of  $\pm 8$  % and an expanded uncertainty of  $\pm 11$  % (acc. to GUM with a coverage factor of  $k = 3$ ).
- 6) **Typical Values:** Due to the special conditions of the manufacturing processes of semiconductor devices, the typical data or calculated correlations of technical parameters can only reflect statistical figures. These do not necessarily correspond to the actual parameters of each single product, which could differ from the typical data and calculated correlations or the typical characteristic line. If requested, e.g. because of technical improvements, these typ. data will be changed without any further notice.
- 7) **Characteristic curve:** In the range where the line of the graph is broken, you must expect higher differences between single devices within one packing unit.
- 8) **Tolerance of Measure:** Unless otherwise noted in drawing, tolerances are specified with  $\pm 0.1$  and dimensions are specified in mm.
- 9) **Tape and Reel:** All dimensions and tolerances are specified acc. IEC 60286-3 and specified in mm.

Not released

---

## Revision History

Version	Date	Change
1.0	2020-11-24	Initial Version
1.1	2020-11-25	Features
1.2	2022-07-05	New Layout Characteristics Features Applications

---

Not released

Not released



EU RoHS and China RoHS compliant product

此产品符合欧盟 RoHS 指令的要求；  
按照中国的相关法规和标准，  
不含有毒有害物质或元素。

**Published by ams-OSRAM AG**

Tobelbader Strasse 30, 8141 Premstaetten, Austria

Phone +43 3136 500-0

[ams-osram.com](http://ams-osram.com)

© All rights reserved

**am** 

**OSRAM**