

DESCRIPTION: 3W3 // M // COAXIAL // CBL MNT

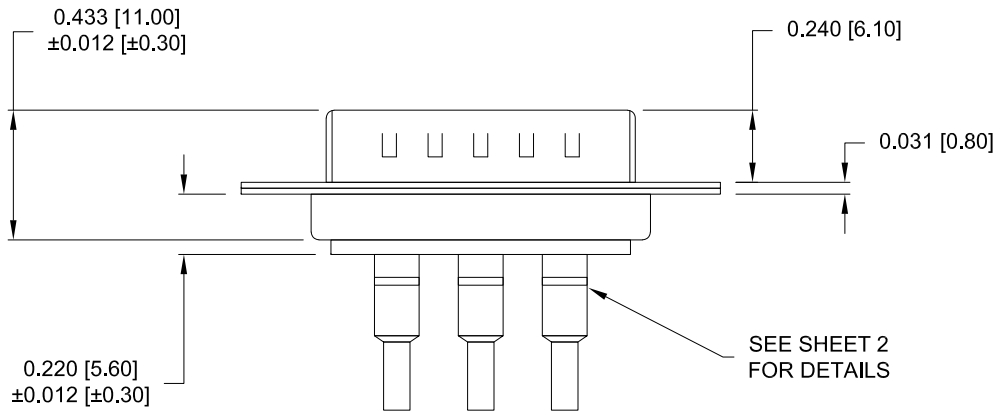
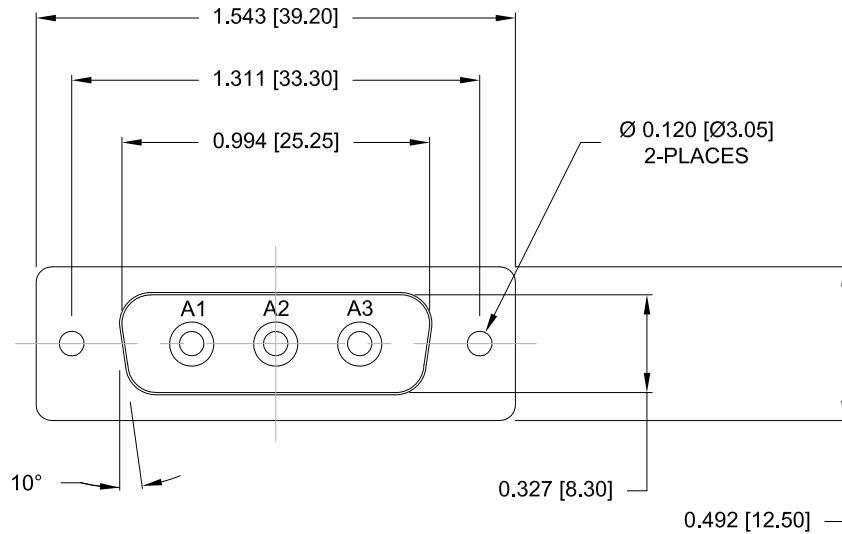

SPECIFICATIONS:

ELECTRICAL:

INSULATOR RESISTANCE: 5 GOHMS Min.
 OPERATING TEMPERATURE: -55° C ~ +125° C
 CONTACT RESISTANCE: 2.7 Milliohms Max.
 COAXIAL CONTACT IMPEDANCE: SEE PART NUMBER KEY

MECHANICAL:

CONTACT INSERTION FORCE: 4.5 Kg Max.
 CONTACT SEPARATOR FORCE: 0.3Kg Min.

MATERIALS:

CONTACTS: COPPER ALLOY
 INSULATOR: PBT UL94V-0 RATED, BLACK
 230°C PROCESS TEMP.
 SHELL: STEEL
 FINISH: NICKEL
 SHELL: NICKEL
 CONTACTS: FULL GOLD FLASH

682M3W3103LYYY

0 = 50 OHM
 (CONTACT NORCOMP) 7 = 75 OHM
 1 = Gold Flash
 0 = NO HARDWARE
 1 = 0.098" CN PCB SIDE
 2 = 0.236" CN PCB SIDE
 3 = 0.236" CN MATING SIDE

RoHS COMPLIANT

UNITS = INCHES [MM] DO NOT SCALE FROM DRAWING



THESE DRAWINGS AND SPECIFICATIONS ARE THE PROPERTY OF NorComp AND SHALL NOT BE REPRODUCED, COPIED OR USED AS THE BASIS FOR THE MANUFACTURE OR SALE OF APPARATUS WITHOUT WRITTEN PERMISSION.

DRAWN: M. SIGMON

DATE: 09/18/2014

NorComp

SCALE: NTS

SHEET 1 OF 3

REV 1

DWG NO: 682M3W3103L001

NOTE:

- COAXIAL CONTACTS SUPPLIED - NOT PRE-LOADED
- PLEASE SEE NORCOMP 682M SERIES WEBSITE PRODUCT PAGE FOR ASSEMBLY INSTRUCTION PDF AND INDIVIDUAL CONTACT DRAWING PDFS

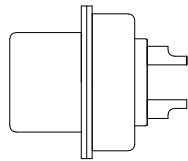

SIGNAL CONTACTS
ACCEPTS UP TO 20 AWG WIRE

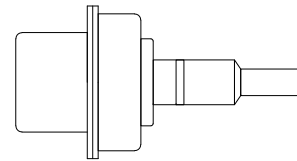

50 OHM COAXIAL CONTACT*
ACCEPTS 50 OHM COAX, RG316/RG174
*75 OHM (CONTACT NORCOMP)

RoHS COMPLIANT

UNITS = INCHES [MM] DO NOT SCALE FROM DRAWING



THESE DRAWINGS AND SPECIFICATIONS ARE THE PROPERTY OF NorComp AND SHALL NOT BE REPRODUCED, COPIED OR USED AS THE BASIS FOR THE MANUFACTURE OR SALE OF APPARATUS WITHOUT WRITTEN PERMISSION.

DRAWN:
M. SIGMON

DATE:
09/18/2014

NorComp

SCALE:
NTS

SHEET OF
2 3

REV
1

DWG NO: 682M3W3103L001

ALL CLINCH-NUTS ARE 4-40 INTERNAL THREADS

0 NO HARDWARE

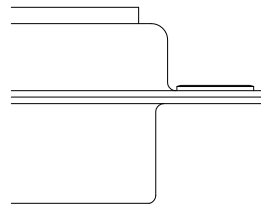

1 0.098" PCB SIDE

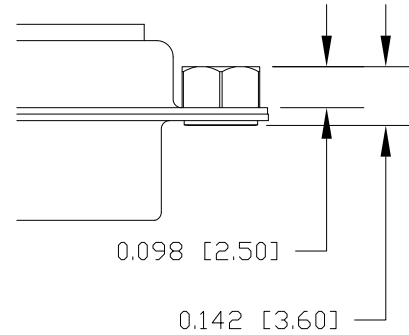

2 0.236" PCB SIDE

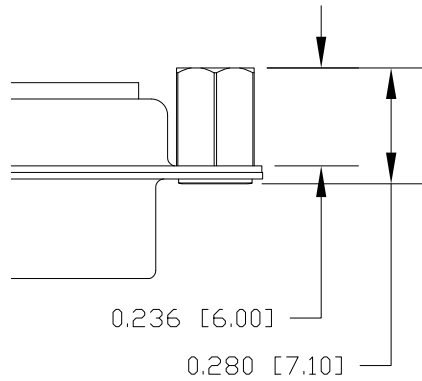

3 0.236" MATING SIDE

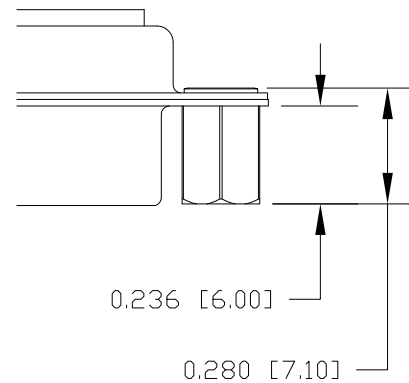

RoHS COMPLIANT

UNITS = INCHES [MM] DO NOT SCALE FROM DRAWING



THESE DRAWINGS AND SPECIFICATIONS ARE THE PROPERTY OF NorComp AND SHALL NOT BE REPRODUCED, COPIED OR USED AS THE BASIS FOR THE MANUFACTURE OR SALE OF APPARATUS WITHOUT WRITTEN PERMISSION.

DRAWN:
M. SIGMON

DATE:
09/18/2014

NorComp

SCALE:
NTS

SHEET OF
3 3

REV
1

DWG NO: 682M3W3103L001