

THIS DRAWING IS UNPUBLISHED  
© COPYRIGHT 2011 BY TE CONNECTIVITY  
RELEASED FOR PUBLICATION 2015  
ALL RIGHTS RESERVED.

LOC		DIST		REVISIONS			
P	LTR	DESCRIPTION	DATE	DWN	APVD		
	NC	NEW RELEASE PER E.O. P20692	14JUL2011	SZ	RDR		
	A	REVISED PER ECO-15-000132	05JAN2015	JA	DM		

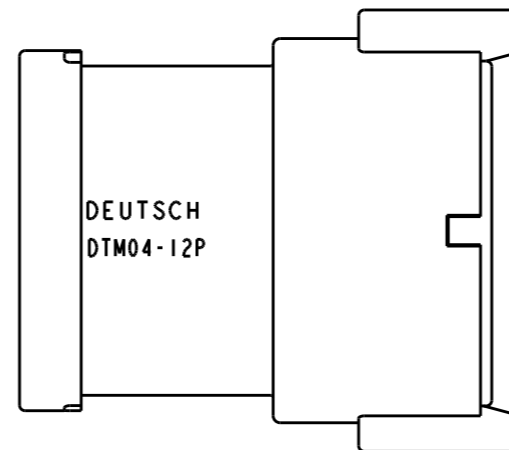

TE INTERNAL PN	DEUTSCH PN
DTM04-12PA-E005	DTM04-12PA-E005
DTM04-12PB-E005	DTM04-12PB-E005
DTM04-12PC-E005	DTM04-12PC-E005
DTM04-12PD-E005	DTM04-12PD-E005

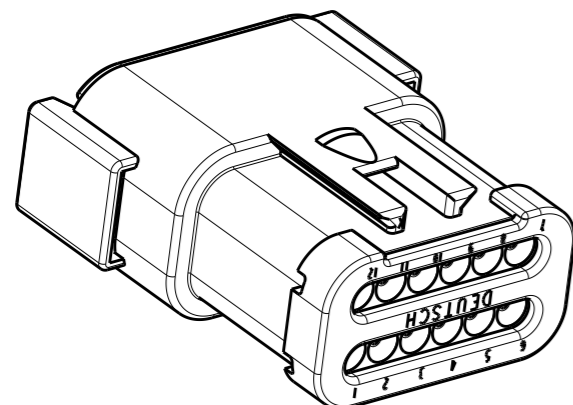
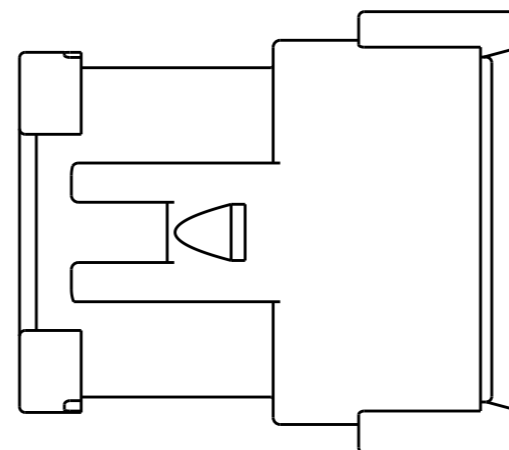
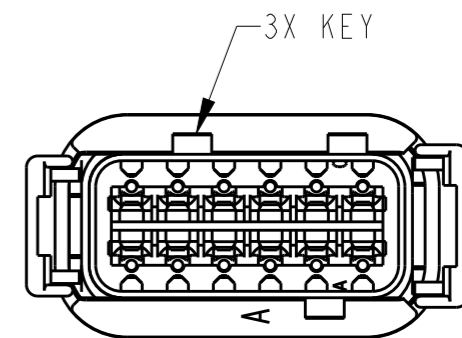
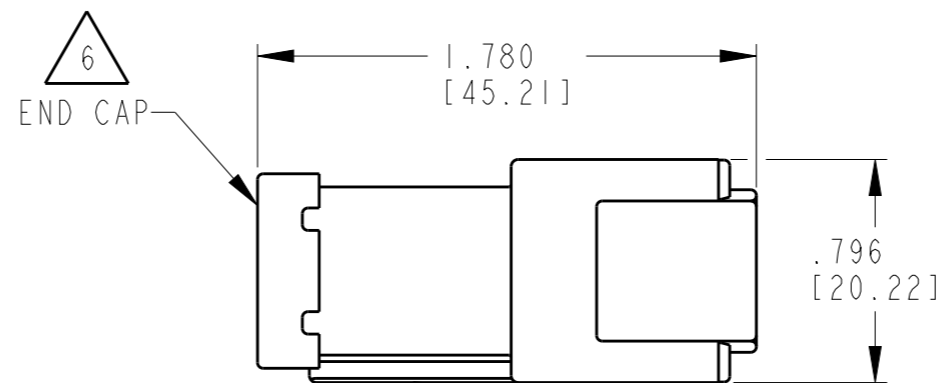
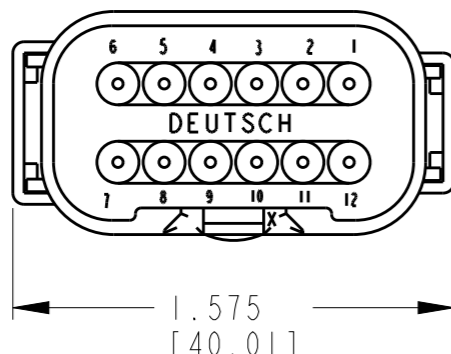

CONTACT SIZE	MIN. INSUL. O.D.	MAX. INSUL. O.D.	WIRE RANGE [mm <sup>2</sup> ] REF ONLY
20	.053 [1.35]	.120 [3.05]	16-20 AWG [1.0-0.5]

- 6 PART MODIFICATION.
- 5. SEE SHEET 2 FOR OTHER KEY ARRANGEMENTS.
- 4 MATERIAL - HOUSING/END CAP: NYLON 6/6 15% GF, COLOR: BLACK; GROMMET: SILICONE.
- 3. THIS RECEPTACLE MATES WITH DTM06-12SX-XXXX PLUG. (X = A,B,C,D KEYS; XXXX = ALL MODIFICATIONS)
- 2 FOR CONTACT AND WIRE PERFORMANCE AND APPLICATION CHARACTERISTICS SEE ENVELOPE DRAWING 0425-015-0000.
- 1. SECONDARY WEDGE LOCK SOLD SEPARATELY: WM-12P.

NOTES: UNLESS OTHERWISE SPECIFIED

THIS DRAWING IS A CONTROLLED DOCUMENT.		DWN 01 JUN 2011 S. ZERMENO			
DIMENSIONS: INCHES [mm]		CHK 06 JUN 2011 BOB MILLIGAN			
TOLERANCES UNLESS OTHERWISE SPECIFIED:		APVD 12 JUL 2011 STEVE BEARD		NAME RECEPTACLE HOUSING 12 PIN SIZE 20 CONTACTS DTM SERIES	
0 PLC ± 1 PLC ± 2 PLC ± 3 PLC ±.025 [0.64] 4 PLC ± ANGLES ±0°30'0"		PRODUCT SPEC 0425-015-0000		SIZE A3	
MATERIAL 4		FINISH N/A		CAGE CODE 4AFU8	
		APPLICATION SPEC 0425-015-0000		DRAWING NO DTM04-12PX-E005	
		WEIGHT 18.92g		RESTRICTED TO -	
		Customer Drawing		SCALE 3:2 SHEET 1 OF 2 REV A	

THIS DRAWING IS UNPUBLISHED  
 RELEASED FOR PUBLICATION 2015  
 © COPYRIGHT 2011 BY TE CONNECTIVITY ALL RIGHTS RESERVED.

LOC	DIST	REVISIONS			
P	LTR	DESCRIPTION	DATE	DWN	APVD
		SEE SHEET 1	-	-	-

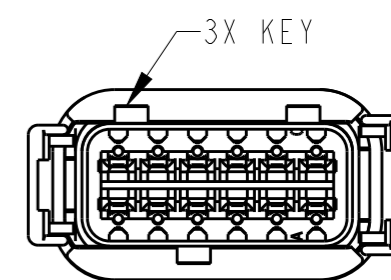
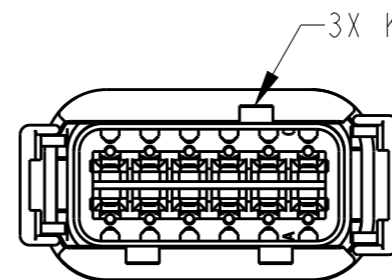
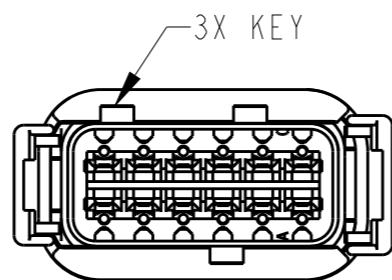
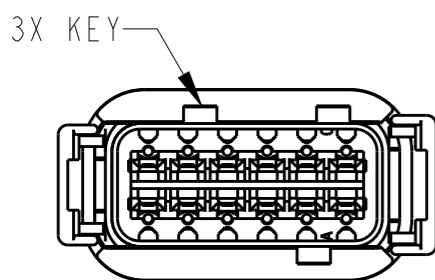
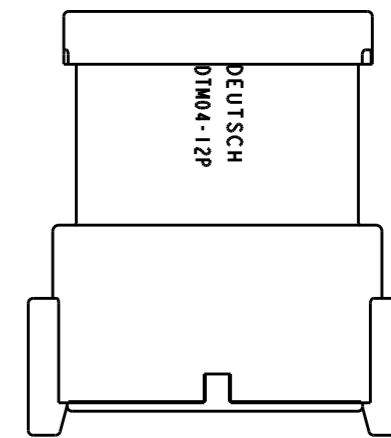
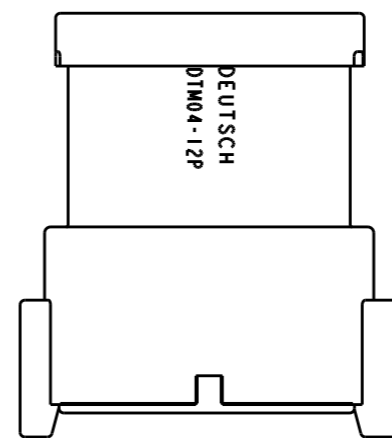
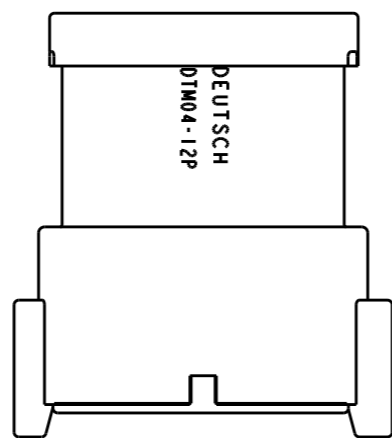
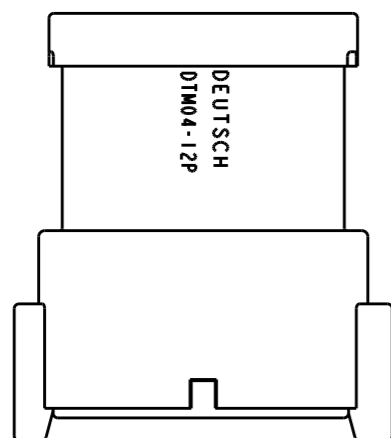

**DTM04-12PA-E005  
KEY -A-**

**DTM04-12PB-E005  
KEY -B-**

**DTM04-12PC-E005  
KEY -C-**

**DTM04-12PD-E005  
KEY -D-**

THIS DRAWING IS A CONTROLLED DOCUMENT.		DWN S. ZERMENO 01 JUN 2011																
DIMENSIONS: INCHES [mm]		CHK BOB MILLIGAN 06 JUN 2011																
TOLERANCES UNLESS OTHERWISE SPECIFIED:		APVD STEVE BEARD 12 JUL 2011	NAME RECEPTACLE HOUSING 12 PIN SIZE 20 CONTACTS DTM SERIES															
<table border="0"> <tr><td>0 PLC</td><td>±</td></tr> <tr><td>1 PLC</td><td>±</td></tr> <tr><td>2 PLC</td><td>±</td></tr> <tr><td>3 PLC</td><td>±.025 [0.64]</td></tr> <tr><td>4 PLC</td><td>±</td></tr> <tr><td>ANGLES</td><td>±0°30'0"</td></tr> </table>		0 PLC	±	1 PLC	±	2 PLC	±	3 PLC	±.025 [0.64]	4 PLC	±	ANGLES	±0°30'0"	PRODUCT SPEC 0425-015-0000	SIZE A3	CAGE CODE 4AFU8	DRAWING NO DTM04-12PX-E005	RESTRICTED TO -
0 PLC	±																	
1 PLC	±																	
2 PLC	±																	
3 PLC	±.025 [0.64]																	
4 PLC	±																	
ANGLES	±0°30'0"																	
MATERIAL 	FINISH N/A	APPLICATION SPEC 0425-015-0000	WEIGHT 18.92g	Customer Drawing		SCALE 3:2	SHEET 2 OF 2	REV A										