

## SUMMARY

### # Wires

Low voltage 20



*Image is for illustrative purpose only*

Series	4B
Termination type	Male crimp
IP rating	50
AWG wire size	24.00 - 20.00
Cable Ø	9.10 - 10.50 mm
Status	active
Matching parts	<a href="#">EGG.4B.320.CLL</a>

### Download

[Request a quote](#)

[Catalog](#)

## TECHNICAL DETAILS

### Mechanics

Shell Style/Model	FN*: Straight plug, cable collet and lanyard release
Keying	1 key (alpha=0, plug: male contacts, receptacle: female contacts)
Housing Material	Brass (chrome plated [SAE AMS 2460]) shell and collet nut, nickel plated [SAE AMS QQ N 290] brass latch sleeve and mid pieces
Variant	Z : Nut for fitting a bend relief
Weight	119.06 g

### Performance

Configuration	4B.320 : 20 Low Voltage
Insulator	Y: PEEK for crimp contacts
Rated Current	8 Amps

### Specifications

Contact Type:	Crimp
Contact Retention:	30 N
Contact Dia.:	0.9 mm (0.035in)
Bucket Dia.:	1.1 mm (0.043in)
Min. Conductor:	0.25 mm <sup>2</sup> (AWG 24)
Max. Conductor:	0.5 mm <sup>2</sup> (AWG 20)

LEMO products and services are provided "as is". LEMO makes no warranties or representations with regard to LEMO product & services or use of them, express, implied or statutory, including for accuracy, completeness, or security. The user is fully responsible for his products and applications using LEMO components.

R (max): 4.8 mOhm  
 Vtest (contact-shell): 950 V (AC), 1340 V (DC)  
 Vtest (contact-contact): 1050 V (AC), 1490 V (DC)

## Others

Endurance (Shell): 5000  
 Temp (min / max): -55° C / +250° C  
 Humidity (max): <=95% [at 60 deg C / 140 F]  
 Vibration: 15 g [10 Hz - 2000 Hz]  
 Shock Resistance: 100 g [ 6 ms]  
 Climatical Category: 50/175/21  
 Shielding (min): 75 dB (10 MHz)  
 Shielding (min): 40 dB (1 GHz)  
 Salt Spray Corrosion: >1000 hr

## DRAWINGS

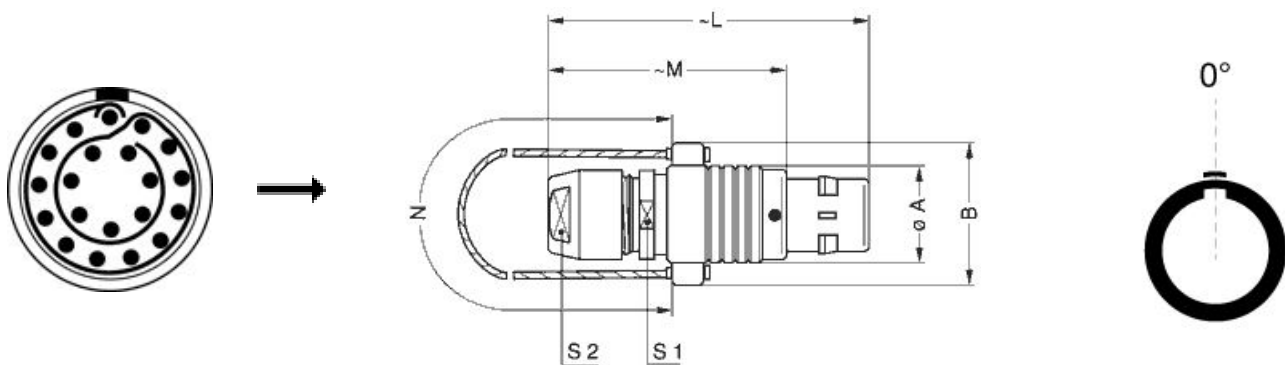

## Dimensions

	A	B	L	M	N	S1	S2
mm.	25	35.2	75	57	230	21	20
in.	0,98	1,39	2,95	2,24	9,06	0,83	0,79

## RECOMMENDED BY LEMO

LEMO products and services are provided "as is". LEMO makes no warranties or representations with regard to LEMO product & services or use of them, express, implied or statutory, including for accuracy, completeness, or security. The user is fully responsible for his products and applications using LEMO components.

## Tools

Crimp Tool:	<a href="#">DPC.91.701.V</a>
Crimp settings:	AWG/Selector = 20-22-24/6-5-5
Positionner:	<a href="#">DCE.91.094.BVC</a>
Extractor:	<a href="#">DCC.09.05B.LAG</a>
Replacement contact:	FGG.4B.560.ZZC

*LEMO products and services are provided "as is". LEMO makes no warranties or representations with regard to LEMO product & services or use of them, express, implied or statutory, including for accuracy, completeness, or security. The user is fully responsible for his products and applications using LEMO components.*