





Transportation Products Catalog

Explore our range of Industry and Board-Level Products that can take your design to the next level.



molex[®]

TABLE OF CONTENTS

SECTION	TITLE	MAXIMUM CURRENT	WIRE GAUGE (AWG)	PITCH	DESIGN CONFIGURATION	PRODUCT FAMILIES
	A Transportation Products	30.0A	12-22	1.00 to 6.00mm (.040 to .236")	Wire-to-Wire, Wire-to-Board	O40 III, O409, AK2 Squib, CMC, CMC CP, DurClik™, H-DAC 64™, HSAutoLink™, Micro-Fit 3.0™, Mini-Fit H20™, Mini-Fit Jr.™, Mini-Fit Sr.™, MOST, MOX, MX123™, MX150™, MX64™, NSCC, OBD-II, Sensors, Splash Proof, Stac64™
	B PCB and Wire Connectors	3.0A	24-32	0.40 to 1.60mm (.016 to .063")	Wire-to-Wire, Wire-to-Board, Board-to-Board, Board-In	CLIK-Mate™, HD Mezz™, Mezzanine IEEE 1386, Mini Mi II™, PanelMate™, PicoBlade™, Pico-Clasp™, Pico-EZmate™, Pico-SPOX™, Plateau HS Dock™, Plateau HS Dock™ PG, Plateau HS Mezz™, SEARAY®, SlimStack™
	C PCB and Wire Connectors	10.0A	16-30	2.00 to 2.50mm (.079 to .098")	Wire-to-Wire, Wire-to-Board, Board-to-Board, Board-In, Cable-to-Board, Panel Detachable	Appli-Mate™, CLIK-Mate™, iGrid™, KK®, Mi II™, MicroBlade™, Micro-Latch™, Milli-Grid™, Mini-Latch™, Mini-Lock™, RAST, Sherlock™, SPOX BMI™, SPOX™
	D PCB and Wire Connectors	5.0A	22-30	2.54mm (.100")	Wire-to-Wire, Wire-to-Board, Board-to-Board	C-Grid III™, C-Grid®, KK®, SL™
	E FFC/FPC Connectors	2.0A	0.10 to 0.30mm (.004 to .012")	0.25 to 2.54mm (.010 to .100")	Wire-to-Board, Flex Circuit-to-Board	BackFlip™, Easy-On™, Premo-Flex™, SL™
	F Ribbon Cable Connectors, Wire Traps	3.0A	24-28	1.27 to 2.54mm (.050 to .100")	Wire-to-Board, Board-to-Board	PicoFlex™, QF-50™, SL™

*SEARAY is a trademark of Samtec, Inc.

Disclaimer

We try to make the illustrations, specifications, dimensions and other information in this catalog accurate as of the date of catalog publication. However, we do not warranty the accuracy, adequacy, timeliness or completeness of the information. This catalog is provided "as is" without warranty of any kind. We expressly disclaim all warranties of merchantability or fitness for a particular purpose.

We will not be liable for any damage, loss or expense including without limitation, direct, indirect, special or consequential damages arising from or in connection with any product, service or information described or contained in this catalog. We reserve the right to change the information without notice. Current sales drawings with dimensions and current specifications are available upon request.

Copyrights

We retain the copyrights to all images, graphics and text in this catalog, unless otherwise noted. Users may make copies of portions of this catalog for their personal, non-commercial use. The copyrighted images, graphics and text in this catalog may not be copied, modified or reused for commercial purposes without our written permission.

Trademarks

The trademarks, service marks and logos in this catalog belong to us, unless otherwise noted. Nothing in this catalog grants any license or right to use any of these trademarks, service marks and logos without our written permission.

Find the Latest Innovations and Information at Molex.com

For the most in-depth and up-to-date information on all our products, visit Molex.com. It's designed to help you get more done in less time with advanced search capabilities, 3D models, product specifications, easy sample ordering and more.



Automotive and Transportation Industry Section

Located in the "Industries" area of our website, this section should be your first stop for a comprehensive overview of our automotive and transportation products. You'll find:

Capabilities Video

This short online video highlights key industry products, as well as our unique cross-functional design and manufacturing capabilities.

Featured Product

To find out about new products that can take your design to the next level, look no further than this convenient product spotlight.

Detailed Application Pages

Whether you're designing a portable navigation system or an in-vehicle network, you can find the products you need right here. Just click on the type of application to see a 3D rendering that shows all of our relevant products and how they work together.

Instant Access to Product Specs

From the 3D rendering, simply click on the product that interests you to access a detailed overview, datasheets, models and more.

Other Time-Saving Site Features

Monthly E-ouncements

Electronic newsletter keeps you up-to-date on our latest innovations

Favorite Products Feature

Lets you select and save up to 200 products as you browse

Electrical Testing Models and Data

Available on an array of products in our "Signal Integrity" section

New Videos, Webinars, Articles and More

Available right from our home page

Series No. Index

<i>Series No.</i>	<i>Page</i>	<i>Series No.</i>	<i>Page</i>	<i>Series No.</i>	<i>Page</i>	<i>Series No.</i>	<i>Page</i>
2695	D-54	8724	D-30	34803	A-10	43650	A-56 to A-59
2759	D-52	21020	E-23, E-24	35021	C-33, C-39	43914	A-45, A-50
3022-NA	C-66	21039	E-27, E-28	35022	C-61, C-65	43915	A-45, A-51
3022-NA	C-67	21049	E-31, E-32	35023	C-33, C-40	43938	A-45, A-50
4030	D-58	30700	A-17, A-18	35047	C-61, C-64	43980	A-45, A-50
4094	D-59	30968	A-17	35053	C-61, C-62	44133	A-66
4455	D-62 to D-64	31067	A-15	35155	C-61, C-63	44242	A-64
4809	D-53	31068	A-15	35164	C-61, C-65	44300	A-67
5045	C-51, C-53	31072	A-15	35184	C-61, C-62	44428	A-66
5046	C-51, C-53	31073	A-15	35362	C-25, C-32	44432	A-65
5051-N	C-44, C-50	31100	A-16	35363	C-25, C-32	44764	A-65
5159	D-52	31101	A-16	35421	A-6	44769	A-64
5240	C-44, C-49	31372	A-12	35438	A-86	44914	A-68
5241	C-44, C-48	31386	A-71	35439	A-86	45280	A-67
5263	C-44, C-45	31387	A-71	35464	A-86	45578	C-44, C-50
5264-N	C-44, C-45	31403	A-72	35465	A-86	45579	C-44, C-49
5267-NA	C-44	33000	A-28	35477	A-90	45970	B-44, B-50
5267-NA-X	C-46	33001	A-27	35507	C-25, C-31	45971	B-44, B-50
5268-NA	C-44, C-47	33011	A-28	35532	A-88	46055	A-52
5320-NA	F-11	33012	A-27	35533	A-89	46056	A-52
5320-NB	F-11	33467	A-69	35563	A-4	46064	A-53
5330	F-14	33468	A-69	35564	A-4	46065	A-53
5332	F-13	33471	A-29	35842	A-87, A-88	47282	C-33, C-43
5340	F-14	33472	A-30	35843	A-87, A-89	49014	A-7
5342	F-13	33476	A-29	35896	A-7	49616	A-93
5556	A-37	33481	A-29	35897	A-7	50011	C-33, C-34
5557	A-38, A-40	33482	A-30	35898	A-7	50012	C-25, C-26
5558	A-37	33486	A-29	42219	C-44, C-46	50013	C-25, C-26
5559	A-38, A-41	34062	A-31	42249	C-44, C-47	50034	C-33, C-38
5566	A-39, A-41, A-42	34080	A-28	42267	C-44, C-48	50038	A-35
5569	A-39, A-40, A-42, A-43	34081	A-27	42375	D-57	50039	A-35
5576	F-15	34083	A-27	42376	D-58	50058	B-44, B-45
5578	F-15	34250	A-31	42377	D-57	50061	B-44, B-48
5597-NAPB7F	E-19	34565	A-71	42815	A-45, A-46	50079	B-44, B-45
5597-NCPB7F	E-18	34566	A-70	42816	A-45, A-47	50080	B-44, B-48
6373	D-59	34575	A-71	42817	A-45, A-46	50097	C-61, C-63
6410	D-60	34576	A-70	42818	A-45, A-47	50147	A-32
6459	D-52	34586	A-69	42819	A-45, A-48	50148	A-32
6471	D-54	34675	A-30	42820	A-45, A-49	50212	C-25, C-28
7395	D-61	34690	A-9	43020	A-60	50351	C-51, C-55
7478	D-60	34691	A-11	43025	A-60	50394	C-5
7720	D-55	34695	A-9	43030	A-54	50420	A-25
7720S	D-56	34696	A-11	43031	A-54	50535	C-66, C-67
7859	D-41	34707	A-13	43045	A-61 to A-63	50641	B-36, B-39
7879	D-53	34708	A-14	43640	A-55	50654	A-3
7880	D-54	34729	A-10	43645	A-55	50660	A-3

Series No. Index

<i>Series No.</i>	<i>Page</i>	<i>Series No.</i>	<i>Page</i>	<i>Series No.</i>	<i>Page</i>	<i>Series No.</i>	<i>Page</i>
50752	C-51, C-55	52559	E-7	53748	B-13, B-18	70004	D-22
50802	C-51, C-52	52584	B-27, B-28	53780	B-36, B-40	70013	D-23
50837	C-51, C-54	52602	B-27, B-28	53885	B-13, B-17	70018	D-21
51004	C-33, C-34	52610	E-15	53916	B-13, B-19	70021	D-6
51005	C-25, C-27	52712	B-59	54102	B-13, B-17	70022	D-22
51006	C-25, C-27	52745	E-8	54104	E-9	70058	D-6
51015	C-33, C-39	52746	E-9	54132	E-10	70066	D-7 to D-10
51021	B-44, B-45	52760	B-20	54167	B-13, B-18	70104	D-21
51022	B-44, B-49	52793	E-17	54363	B-13, B-16, E-4	70107	D-20
51035	C-61, C-64	52808	E-17	54477	B-2, B-8	70204	D-33
51065	C-25, C-28	52837	B-20	54596	B-36, B-40	70216	D-30
51089	C-18	52852	E-18	54597	B-36, B-41	70229	D-33
51090	C-16	52885	B-20, B-21	54684	B-2, B-12	70246	D-35
51094	C-17	52901	B-20, B-22	54729	B-13, B-15	70247	D-36
51102	C-51, C-56	52991	B-13, B-18	54765	B-2, B-8	70280	D-27
51103	C-51, C-56	53014	C-33, C-35	54809	E-6	70400	D-14 to D-17, F-17
51110	C-5	53015	C-33, C-35	55091	B-20, B-23	70430	E-20 to E-22
51115	A-26	53025	C-33, C-36	55339	B-2, B-7	70431	E-22
51116	A-26	53047	B-44, B-47	55450	B-36, B-41	70450	D-10 to D-12
51128	C-66, C-68	53048	B-44, B-47	55454	B-36, B-42	70475	D-19, F-17
51146	B-36, B-39	53253	C-25, C-29	55456	B-36, B-42	70541	D-24
51163	C-51, C-57	53254	C-25, C-29	55482	B-36, B-43	70543	D-23
51164	C-51, C-57	53261	B-44, B-46	55487	C-33, C-38	70545	D-25
51191	C-51, C-52	53290	C-33, C-41	55526	B-11, B-2	70551	D-26
51198	C-51, C-54	53307	B-20, B-24	55559	B-13, B-16	70553	D-25
51216	C-33, C-37	53309	B-20, B-25	55604	B-2, B-9	70555	D-26
51217	C-33, C-37	53313	C-19	55650	B-13, B-15	70567	D-31
51281	E-13	53314	C-19	55909	B-2, B-9	70568	D-31
51296	E-11	53324	C-17	57919	A-6	70634	D-27
51338	B-2, B-10	53325	C-18	59205	B-13, B-14	71308	D-29
51441	E-11	53353	B-20, B-26	59370	C-33, C-36	71349	D-32
52044	E-20	53358	C-20	64002	A-4	71395	D-39
52045	E-19	53364	B-20, B-25	64318	A-76	71436	B-27, B-31
52116	A-36	53375	C-51, C-58	64319	A-77	71439	B-27, B-31
52117	A-36	53395	B-27, B-29	64320	A-78	71741	B-27, B-32
52147	F-18	53398	B-44, B-46	64321	A-79	71742	B-27, B-32
52151	F-18	53408	B-27, B-29	64322	A-83	71764	D-29
52207	E-16	53426	C-51, C-59	64323	A-83	71850	D-38
52213	A-33	53481	B-20	64324	A-84	71851	D-7
52266	A-34	53517	C-51, C-60	64325	A-82	71973	D-40
52271	E-16	53526	C-66, C-68	68145	A-5	71979	D-39
52418	C-33, C-41	53551	B-20	68147	A-90	73838	D-10
52435	E-8	53553	B-20	68151	A-5	74099	D-24
52437	E-10	53625	B-20, B-21	68370	D-65	75018	B-51, B-54
52465	B-20, B-24	53627	B-20, B-23	68507	A-4	75019	B-51, B-54
52484	C-16	53647	B-20, B-22	68508	A-4	75100	D-34

Series No. Index

<i>Series No.</i>	<i>Page</i>	<i>Series No.</i>	<i>Page</i>	<i>Series No.</i>	<i>Page</i>	<i>Series No.</i>	<i>Page</i>
75102	D-28	90130	D-49	98684	A-21	502380	B-36, B-37
75126	B-51, B-55	90131	D-46	98685	A-23	502381	B-36, B-37
75140	B-51, B-54	90136	D-48	98761	A-85	502382	B-36, B-38
75475	B-51, B-56	90142	D-44	98944	A-80	502386	B-36, B-38
75476	B-51, B-56	90147	D-37	98950	A-81	502426	B-2, B-7
79107	C-4, C-6	90148	D-38	104004	A-93	502430	B-2, B-6
79109	C-4 to C-7	90151	D-50	111005	A-92	502438	C-23
87263	C-4, C-8	90152	D-50	111014	A-92	502439	C-23
87264	C-4, C-7	90170	F-12	111015	A-91	502443	C-24
87340	C-4, C-9	90325	F-4	111019	A-94	502494	C-24
87368	C-4, C-8	90327	F-2	111041	A-94	502578	B-51, B-52
87369	C-25, C-30	90584	F-2	111082	A-91	502579	B-51, B-52
87381	C-4, C-9	90635	F-12	111083	A-91	502584	B-51, B-53
87421	B-51, B-57	90663	F-16	500024	B-2, B-6	502585	B-51, B-53
87427	A-43, A-44	90779	F-5	500027	B-2, B-5	502611	E-15
87437	B-51, B-57	90800	F-6	500334	B-13, B-17	502761	E-5
87438	B-51, B-58	90814	F-4	500678	B-13, B-14	502790	E-12
87439	B-51, B-58	90816	F-7	500913	B-2, B-10		
87568	C-10	91330	F-5	500797	E-6		
87569	C-10	91616	A-22	501044	B-2, B-3		
87758	C-42	91714	F-6	501083	B-2, B-3		
87759	C-42	91716	C-66, C-69	501189	B-27, B-34		
87797	D-66	91780	C-66, C-69	501190	B-27, B-35		
87819	B-2, B-12	91821	F-3	501193	B-27, B-35		
87820	B-2, B-11	91935	F-3	501330	B-27, B-33		
87831	C-11	92315	F-7	501331	B-27, B-34		
87832	C-11	92316	F-9	501334	B-27, B-33		
87833	C-12	92317	F-8	501461	E-12		
87834	D-35	92318	F-8	501591	B-2, B-5		
87871	B-44, B-48	94552	A-20	501594	B-2, B-4		
87872	B-44, B-49	98122	A-84	501616	E-4		
87891	D-65	98193	A-19	501628	E-5		
87897	D-65	98266	E-25, E-26	501645	C-22		
87898	D-65	98267	E-29, E-30	501646	C-21		
87939	D-66	98268	E-33, E-34	501647	C-21		
87981	C-12	98273	A-24	501648	C-21		
87982	C-12	98276	A-24	501800	B-2, B-4		
87983	C-12	98298	A-20	501876	C-22		
87984	C-12	98438	A-25	501912	E-7		
87985	C-13	98599	A-21	501951	E-13		
89400	C-25, C-30	98615	A-21	502078	E-3		
89401	C-25, C-31	98649	A-80	502231	E-14		
90059	D-42	98655	A-81	502244	E-14		
90119	D-44	98658	A-19	502250	E-3		
90120	D-45	98660	A-23	502351	A-8		
90122	D-47	98681	A-22	502352	A-8		

Overview	A-2
1.00mm (.040") Pitch System – 040 III	A-3 to A-5
1.00/2.30mm (.040/.090") Pitch System – 0409 Hybrid Housings	A-6 to A-7
DuraClik™	A-8
Stac64™	A-9 to A-14
H-DAC 64™	A-15 to A-18
MOX System	A-19 to A-21
MOST System	A-21 to A-23
NSCC System	A-24 to A-25, A-54 to A-55
OBD-II Connectors	A-25 to A-26
MX150™ Sealed Connector System	A-27 to A-31
2.50mm (.098") Pitch Wire-to-Wire Splash Proof Connectors	
Terminals	A-32, A-35
Receptacles	A-33
Plugs	A-34
Receptacle Housing and Plug Housing	A-36
Mini-Fit®	A-37
Mini-Fit Jr.™	A-38 to A-44
Mini-Fit Sr.™	A-45 to A-51
Mini-Fit H20™	A-52 to A-53
Micro-Fit 3.0™	A-54 to A-67
Micro-Fit CPI™	A-67 to A-68
MX123™ Sealed Connector System	A-69 to A-71
MX64™ Sealed Connector System	A-72
CMC System	A-73 to A-82
CMC CP System	A-83 to A-84
Bulb Sockets	
Terminals	A-86
Bulb Sockets	A-87
PT Bulb Sockets	A-88 to A-89
Wedge Bulb Sockets	A-90
HSAutoLink™ Cable Assemblies	A-91 to A-95
AK2 Squib Connectors	A-96
Sensors	A-97

Visit www.molex.com to access more part numbers and product information, download sales drawings, product specifications, 3D models, place sample requests, and more.

As a major supplier to the global automotive industry, Molex offers vehicle manufacturers and their suppliers a wide range of products and extensive research and development capabilities that include rapid prototyping and high volume production support. In addition, we apply breakthrough technologies from other markets and industries and apply them to in-vehicle electronic devices.

The average new vehicle today contains twice as many connectors as models produced only ten years ago. As electronic content increases in automotive vehicles, Molex is responding with solutions that simplify electrical distribution systems. We are dedicated to reducing weight and packaging space while boosting performance and reliability. Many products incorporate our proprietary technologies in shielding, filtering and assembly.

Our automotive design teams are located in technical centers throughout the world and are linked electronically to share expertise and expedite development. All of our manufacturing sites are ISO 9000 and QS 9000 certified and we currently support automotive manufacturing in all areas of the world.

We are dedicated to developing products that address the growing demand for innovative electrical interfaces, and Molex has created and defined new industry standards by partnering with many agencies including USCAR.

Molex has created unique connector interfaces for four key application segments:

Power train

- Fully sealed, high performance interconnect systems that offer the densest package in the automotive market
- MX123™ and CMC accommodate low level signal and high current load requirements
- Mate assist receptacles reduce harness assembly complexity by integrating the housing, lever, terminal retention feature and connector retention features in one standard assembly
- Sealing performance and package size are optimized by utilizing interfacial and matte seal technologies
- Applications include: on-engine, off road construction, industrial equipment

Sealed

- Wide standard product portfolio dedicated to offering low and stable contact resistance in harsh applications
- Available in matte sealed and cable sealed versions, the MX150™ systems are designed to support current loading for both low-level signal and power applications up to 22.0A.
- The MX150 connector footprint and profile has been adapted by industry agency USCAR as their design criteria for systems supporting this specification
- Applications include: exterior lighting, door lock mechanisms, fuel injectors, spark plugs, wiper motors, washers, power steering and hosts of other safety devices

Unsealed

- Stac64™, the modular 0.64mm, 1.50mm and 2.80mm terminal interconnect system, addresses the growing electronic device requirements within today's vehicles by supporting both low-level signal requirements and power requirements up to 30 amps
- Fully-validated to USCAR specifications, Stac64 header assemblies can be used as stand alone components or multiple headers may be ganged together to support a large range of signal and power needs without the need for additional tooling
- Other product in this application segment include: H-DAC64™, MOST, MOX, NSCC
- Applications include: radios, amplifiers, power seats, HVAC, door zone modules, interior lighting, electronic mirrors and most interior electronic interfaces

High Speed

- Molex's HSAutoLink™ family is the emerging high-speed data bus for vehicles, encompassing technologies such as Universal Serial Bus (USB 2.0), Low Voltage Differential Signaling (LVDS), 1394, FlexRay, eMOST and Ethernet
- Leveraging data communications expertise, Molex has packaged an economical and widely deployed five-pin shielded connection system from the consumer market into a more rugged connector system to meet automakers' mechanical requirements and to bring USB and other technologies to vehicle information and entertainment systems
- USCAR-30 supports USB 2.0 requirements for OEM system certification
- Applications include: MP3 players, infotainment, telematic devices, safety cameras and displays



MX123™



CMC



MX150™



Stac64™



HSAutoLink™

1.00mm (.040") Tab Terminal

50654
Female

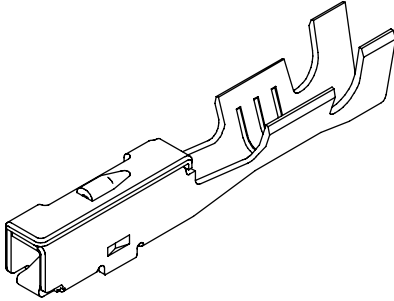

Order No.	Wire Range (mm ²)	Lead-free
50654-1001	AVS (AVSS) 0.3-0.5	Yes

Features and Benefits

- Locking tab secures terminal to housing

Reference Information

Product Specification: PS-68145-002
 Packaging: Reel
 Mates With: 50660 Terminal
 Use With: 35563, 35564, 35896, 35898, 49014, 64002 and 68508 housings
 Designed In: Millimeters

Electrical

Voltage: 13V
 Current: 5.0A max.
 Contact Resistance: 5 milliohms max.
 Dielectric Withstanding Voltage: 1000V AC
 Insulation Resistance: 500V DC Megohms min.

Mechanical

Contact Insertion Force: 1.5 kgf max.
 Contact Retention to Housing: 8.0 kgf min.
 Durability: 50 cycles

Physical

Contact: Copper Alloy
 Plating: Pre-Tin

www.molex.com/customer.html?seriesNumber=50654

1.00mm (.040") Tab Terminal

50660
Male

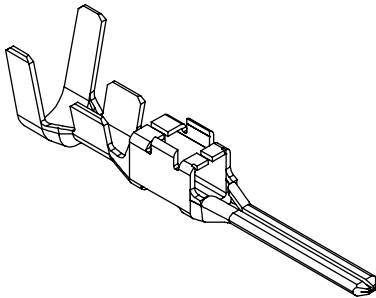

Order No.	Wire Range (mm ²)	Lead-free
50660-9001	AVS (AVSS) 0.3-0.5	Yes

Features and Benefits

- Locking tab secures terminal to housing

Reference Information

Product Specification: PS-68145-002
 Packaging: Reel
 Mates With: 50654 terminal
 Use With: 35897, 35899, 49016, 49102 and 68507 housings
 Designed In: Millimeters

Electrical

Voltage: 13V
 Current: 5.0A max.
 Contact Resistance: 5 milliohms max.
 Dielectric Withstanding Voltage: 1000V AC
 Insulation Resistance: 500V DC 100 Megohms min.

Mechanical

Contact Insertion Force: 1.5 kgf max.
 Contact Retention to Housing: 8.0 kgf min.
 Durability: 50 cycles

Physical

Contact: Brass
 Plating: Pre-Tin

1.00mm (.040") Tab Wire-to-Wire/ Wire-to-Board 040 111 Housing

68508/64002/35563/35564
Female, 2 Rows

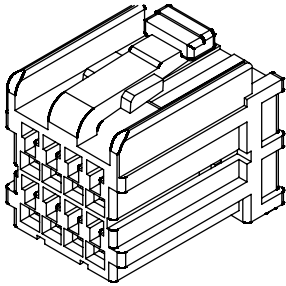

Circuits	Order No.	Color
8	68508-0811	Black
	68508-0815	Gray
12	64002-1210	White
	64002-1215	Gray
16	35563-1610	White
	35563-1615	Gray
20	35564-2010	White
	35564-2015	Gray

Features and Benefits

- Meets industry-standard requirements for 040 automotive interface
- Side Terminal Position Assurance (TPA) feature virtually eliminates terminal backout
- Rugged contact design offers increased life cycle durability and mechanical and electrical reliability
- Fully shrouded to protect contacts

Reference Information

Product Specification: PS-68145-002
Packaging: Bag
Mates With: 53874, 68145 and 68151
Use With: 50654
Designed In: Millimeters

Electrical

Voltage: 13V
Current: 5.0A max.
Contact Resistance: 5 milliohms max.
Dielectric Withstanding Voltage: 1000V AC
Insulation Resistance: 500V DC 100 Megohms min.

Mechanical

Contact Insertion Force: 1.5 kgf max.
Contact Retention to Housing: 8.0 kgf min.

Circuits	Mating Force (kgf. max.)	Unmating Force (kgf. max.)
8	10	10
12		
16	15	15
20		

Durability: 50 cycles

Physical

Housing: Polyester, UL 94-HB

www.molex.com/customer.html?seriesNumber=68508

1.00mm (.040") Tab Wire-to-Wire 040 III Housing

68507/64002
Male, 8 Circuits, 2 Rows

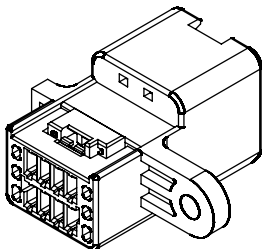

Circuits	Order No.	Type
8	68507-0811	Screw
	68507-0821	Clip
12	64002-1210	Screw
	64002-1215	

Features and Benefits

- Meets industry-standard requirements for 040 automotive interface
- Side Terminal Position Assurance (TPA) feature virtually eliminates terminal backout
- Rugged contact design offers increased life cycle durability, and mechanical and electrical reliability
- Side flange provides panel mounting retention
- Fully shrouded to protect contacts

Reference Information

Product Specification: PS-35896-001 and PS-68507-003
Packaging: Bag
Mates With: 68508, 64022
Use With: 50654 and 50660
Designed In: Millimeters

Electrical

Voltage: 13V
Current: 5.0A max.
Contact Resistance: 5 milliohms max.
Dielectric Withstanding Voltage: 1000V AC
Insulation Resistance: 500V DC 100 Megohms min.

Mechanical

Contact Insertion Force: 1.5 kgf max.
Contact Retention to Housing: 8.0 kgf min.
Mating Force: 10 kgf max.
Unmating Force: 10 kgf max.
Durability: 50 cycles

Physical

Housing: Polyester, UL 94-HB

1.00mm (.040") Tab Wire-to-Board 040 III Header 68145/68151-XX1X Vertical

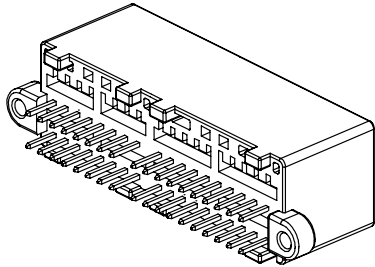

Features and Benefits

- Meets industry-standard requirements for 040 automotive interface
- Rugged contact design offers increased life cycle durability and mechanical and electrical reliability
- Fully shrouded to protect contacts

Reference Information

Product Specification: PS-68145-002 and PS-68145-005
 Packaging: Tray
 Mates With: 35563, 35564, 64002 and 68508
 Use With: 50654
 Designed In: Millimeters

Electrical

Voltage: 13V
 Current: 5.0A max.
 Contact Resistance: 10 milliohms max.
 Dielectric Withstanding Voltage: 1000V AC
 Insulation Resistance: 500V DC 100 Megohms min.

Mechanical

Contact Insertion Force: 1.5 kgf max.
 Contact Retention to Housing: 8.0 kgf min.

Circuits	Mating Force (kgf. max.)	Unmating Force (kgf. max.)
8	10	10
12		
16	15	15
20		
28	18	18
36		

Durability: 50 cycles

Physical

Housing: Polyester, UL 94-HB
 Contact: Brass
 Plating: Contact Area—Tin
 Solder Tail Area—Tin
 Underplating: Copper
 PCB Thickness: 1.6mm (.062")

Circuits	Order No.	Color	Lead-free
8	68145-0811	Black	Yes
	68145-0815	Gray	
12	68145-1211	Black	
	68145-1215	Gray	
16	68145-1615		
20	68151-2015		
28	68145-2815		
	68145-2811	Gray	
36	68145-3615		

1.00mm (.040") Tab Wire-to-Board 040 III Header 68145/68151-XX2X Right Angle

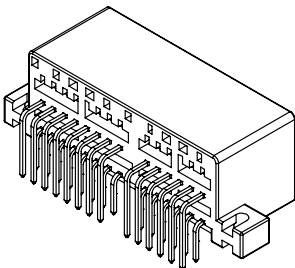

Features and Benefits

- Meets industry-standard requirements for 040 automotive interface
- Rugged contact design offers increased life cycle durability and mechanical and electrical reliability
- Fully shrouded to protect contacts

Reference Information

Product Specification: PS-68145-002 and PS-68145-005
 Packaging: Tray
 Mates With: 35563, 35564, 64002 and 68508
 Use With: 50654
 Designed In: Millimeters

Electrical

Voltage: 13V
 Current: 5.0A max.
 Contact Resistance: 5 milliohms max.
 Dielectric Withstanding Voltage: 1000V AC
 Insulation Resistance: 500V DC 100 Megohms min.

Mechanical

Contact Insertion Force: 1.5 kgf max.
 Contact Retention to Housing: 8.0 kgf min.
 Mating Force: 15 kgf max.
 Unmating Force: 15 kgf max.
 Durability: 50 cycles

Physical

Housing: Polyester, UL 94-HB
 Contact: Brass
 Plating: Contact Area—Tin
 Solder Tail Area—Tin
 Underplating: Copper
 PCB Thickness: 1.6mm (.062")

Circuits	Order No.	Color	Lead-free
8	68145-0821	Black	Yes
	68145-0825	Gray	
12	68145-1221	Black	
	68145-1225	Gray	
16	68145-1625		
20	68151-2025		
28	68145-2825		
	68145-2821		
36	53874-3615		

2.30mm (.090") Tab Terminal

35421
Female

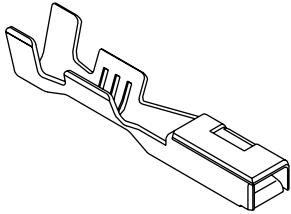

Order No.	Wire Range (mm ²)	Lead-free
35421-6702	AVS (CAVS) 0.30 to 0.50 (.012 to .020)	Yes
35421-6802	AVS (CAVS) 0.50 to 1.25 (.020 to .050)	
35421-6902	AVSS 2f	

Features and Benefits

- Housing-locking feature avoids deformation of terminal
- Accepts wide wire range (0.3 to 2.0mm²)

Reference Information

Product Specification: PS-35282
 Packaging: Reel
 Mates With: 35420-9702/9802/9902
 Use With: 35284 housing
 Designed In: Millimeters

Electrical

Voltage: 13V
 Current:

Wire Size	Current
0.3	6A
0.5	8A
0.85	10A
1.25	14A
2.0	18A

Contact Resistance: 3 milliohms max.
 Dielectric Withstanding Voltage: 1000V AC
 Insulation Resistance: 500V DC 100 Megohms min.

Mechanical

Contact Insertion Force: 1.5 kgf max.
 Contact Retention to Housing: 10 kgf min.
 Durability: 50 cycles

Physical

Contact: Copper Alloy
 Plating: Tin

www.molex.com/customer.html?seriesNumber=35421

2.30mm (.090") Tab Terminal

57919
Male

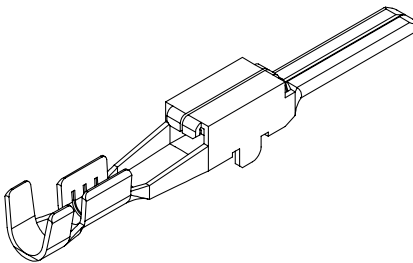

Order No.	Wire Range (mm ²)	Insulation Diameter	Lead-free
57919-6702	0.3-0.5	2.60mm (.102") max.	Yes
57919-6802	0.85-1.25	2.90mm (.115") max.	
57919-6902	2.0		

Features and Benefits

- Locking tab secures terminal to housing

Reference Information

Product Specification: PS-35896-2090
 Packaging: Reel
 Mates With: 35421 Terminal
 Use With: 35897 and 49016 housings
 Designed In: Millimeters

Electrical

Voltage: 13V
 Current:

Wire Size	Current
0.3	6A
0.5	8A
0.85	10A
1.25	14A
2.0	18A

Contact Resistance: 3 milliohms max.
 Contact Resistance: 10 milliohms max.
 Dielectric Withstanding Voltage: 1000V AC
 Insulation Resistance: 500V DC 100 Megohms min.

Mechanical

Contact Insertion Force: 1.5 kgf max.
 Contact Retention to Housing: 10 kgf min.
 Durability: 50 cycles

Physical

Contact: Brass
 Plating: Pre-Tin

1.00/2.30mm (.040/.090") Tab Wire-to-Wire 0409 Hybrid Housing 49014/35898/35896 Female

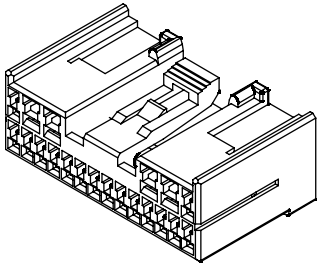

Features and Benefits

- Meets industry-standard requirements for 040/090 automotive interface
- Side Terminal Position Assurance (TPA) feature virtually eliminates terminal backout
- Rugged contact design offers increased life cycle durability, and mechanical and electrical reliability
- Side flange provides panel mounting retention
- Fully shrouded to protect contacts
- Hybrid structure:
1.00mm (.040") terminals for signal circuits
2.30mm (.090") terminals for normal circuits

Circuits	Signal	Normal
20	16	4
22	18	
24	20	

Reference Information

Product Specification: PS-35896-001 and PS-68507-003
 Packaging: Bag
 Mates With: 35897, 35899 and 49016
 Use With: 35421 and 50654
 Designed In: Millimeters

Electrical

Voltage: 13V
 Current: 5.0A max. (.040")
 10.0A max. (.090")
 Contact Resistance: 3 milliohms max. (090)
 5 milliohms max. (040)
 Dielectric Withstanding Voltage: 1000V AC
 Insulation Resistance: 500V DC 100 Megohms min.

Mechanical

Contact Insertion Force: 1.5 kgf max.
 Contact Retention to Housing: 8 kgf min. (040)
 10 kgf min (090)

Circuits	Mating Force (kgf. max.)	Unmating Force (kgf. max.)
10	14	14
14	18	18
20		
22		
24		

Durability: 50 cycles

Physical

Housing: White Polyester, UL 94-HB

Circuits	Order No.
14	35898-1410
20	35896-2010
22	35896-2210
24	35896-2410

www.molex.com/customer.html?seriesNumber=49014

1.00/2.30mm (.040/.090") Tab Wire-to-Wire 0409 Hybrid Housing 35897 Male

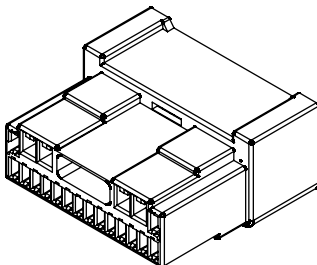

Features and Benefits

- Meets industry-standard requirements for 040/090 automotive interface
- Side Terminal Position Assurance (TPA) feature virtually eliminates terminal backout
- Rugged contact design offers increased life cycle durability, and mechanical and electrical reliability
- Side flange provides panel mounting retention
- Fully shrouded to protect contacts

Reference Information

Product Specification: PS-35896-2090
 Packaging: Bag
 Mates With: 35896
 Use With: 50660 and 57919
 Designed In: Millimeters

Electrical

Voltage: 13V
 Current: 5.0A max. (.040")
 10.0A max. (.090")
 Contact Resistance: 3 milliohms max. (090)
 5 milliohms max. (040)
 Dielectric Withstanding Voltage: 1000V AC
 Insulation Resistance: 500V DC 100 Megohms min.

Mechanical

Contact Insertion Force: 1.5 kgf min.
 Contact Retention to Housing: 8 kgf min. (040)
 10 kgf min (090)

Mating Force: 18 kgf max.
 Unmating Force: 18 kgf max.
 Durability: 50 cycles

Physical

Housing: Polyester, UL 94-HB

Circuits	Order No.
20	35897-2010
22	35897-2210
24	35897-2410

2.00mm (.079") Pitch DuraClik™ Wire-to-Board Receptacle Housing

502351
Single Row, Right Angle
SMT, Positive Lock

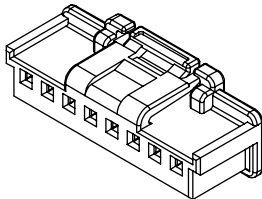

Circuits	Order No.	Lead-free
2	502351-0200	Yes
4	502351-0400	
6	502351-0600	
8	502351-0800	

Features and Benefits

The Molex DuraClik™ 2.00mm (.079") wire-to-board interconnect system provides reliable secure mating and PCB retention for high tolerance vibration applications. It is an ideal fit for wiper/blinker levers, air conditioner, navigation meters and other instrumentation applications.

- Positive lock
- Inner lock system
- Big end fitting nails
- Tail protector
- Polarization features

Reference Information

Product Specification: PS-502351-001
Packaging: Embossed tape
Mates With: 502351-**-00
Designed In: Millimeters

Electrical

Voltage: 125V
Current: 3.0A
Contact Resistance: 10 milliohms max.
Dielectric Withstanding Voltage: 500V AC
Insulation Resistance: 1000 Megohms min.

Mechanical

Contact Insertion Force: 9.8N max.
Contact Retention to Housing: 9.8N min.
Wire Pull-Out Force: 9.8N min

Physical

Housing: 502352—PA9T
Plating: Contact Area—Tin
Solder Tail Area—Tin
Underplating—Nickel
Insulation Diameter: 0.8-1.4mm
Strip Length: 1.3-1.8mm (ref.)
Wire Gauge: AWG#22-30

2.00mm (.079") Pitch DuraClik™ Wire-to-Board Header

502352
Single Row, Right Angle
SMT, Positive Lock

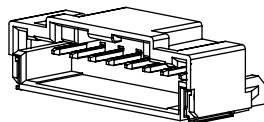

Circuits	Order No.	Lead-free
2	502352-0200	Yes
4	502352-0400	
6	502352-0600	
8	502352-0800	

Features and Benefits

The Molex DuraClik™ 2.00mm (.079") wire-to-board interconnect system provides reliable secure mating and PCB retention for high tolerance vibration applications. It is an ideal fit for wiper/blinker levers, air conditioner, navigation meters and other instrumentation applications.

- Positive lock
- Inner lock system
- Big end fitting nails
- Tail protector
- Polarization features

Reference Information

Product Specification: PS-502351-001
Packaging: Embossed tape
Mates With: 502351-**-00
Designed In: Millimeters

Electrical

Voltage: 125V
Current: 3.0A
Contact Resistance: 10 milliohms max.
Dielectric Withstanding Voltage: 500V AC
Insulation Resistance: 1000 Megohms min.

Mechanical

Contact Insertion Force: 9.8N max.
Contact Retention to Housing: 9.8N min.
Wire Pull-Out Force: 9.8N min

Physical

Housing: PA9T
Plating: Contact Area—Tin
Solder Tail Area—Tin
Underplating—Nickel
Insulation Diameter: 0.8-1.4mm
Strip Length: 1.3-1.8mm (ref.)
Wire Gauge: AWG#22-30

2.54mm (.100") Pitch Stac64™ Header

34695
Vertical
Single-Bay Hybrid

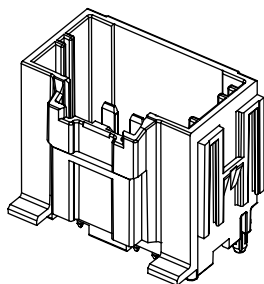

Features and Benefits

- PCB alignment posts ensure all terminals are properly aligned into PCB through-holes during assembly and retain header to PCB during assembly and solder processing
- PCB stand-offs molded into housings provide additional trace-routing real estate under the headers
- High temperature thermoplastic housings withstand infra red (IR) and wave lead-free solder processing per ES-40000-5013 Molex specification
- Stackable connection system of readily available PCB headers ensure reduced time-to-market: engineering and validation times reduced significantly, no tooling necessary to produce custom multi-bay headers
- Pre-assembled, linear Mylar PC tail alignment strip for right-angle headers reduces PCB packaging complexity and provides space savings
- The header housings are molded in standard USCAR color schemes for additional polarizations to match harness connector color-coding scheme for visual aid in assembly
- Modular-housing design with standard dovetail features molded into the housings allows headers to be ganged together in large assemblies to meet growing terminal quantity requirements

Reference Information

Packaging: Male Headers—Tray
Mates With: Series 31372 female connectors
Designed In: Millimeters

Electrical

Voltage: 500V max.
Current: 2.80mm (.110")—30.0A max.
1.50mm (.059")—18.0A max.
Dielectric Withstanding Voltage: 500V DC
Isolation Resistance: 20 Megohms min.
Durability: 10 milliohms max.—10 cycles
Header Pin retention Force:
2.80mm (.110")—70N (15.7 lb) min.
1.50mm (.059")—70N (15.7 lb) min.

Physical

Header Housings: Glass filled SPS
Contact:
2.80mm (.110") blades—Copper Alloy
1.50mm (.059") blades—Copper Alloy
Plating:
1.50mm (.059") blades: Overplating—Tin
Underplating—Nickel
2.80mm (.110") blades: Overplating—Tin
Underplating—Nickel

Circuit Size	Order No.	Polarization Option	Color	Packaging	Assembly Features	Headers
10	34695-0100	A	Black	Tray	Housing and Blades Assembly	Power
	34695-0101	B	Grey			

2.54mm (.100") Pitch Stac64™ Header

34690
Vertical
Single-Bay

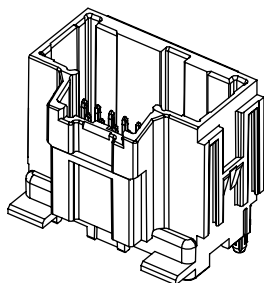

Features and Benefits

- PCB alignment posts ensure all terminals are properly aligned into PCB through-holes during assembly and solder processing
- PCB stand-offs molded into housings provide additional trace-routing real estate under the headers
- High temperature thermoplastic housings withstand infra red (IR) and wave lead-free solder processing per ES-40000-5013 Molex specification
- Stackable connection system of readily available PCB headers ensure reduced time-to-market: engineering and validation times reduced significantly, no tooling necessary to produce custom multi-bay headers
- The header housings are molded in standard USCAR color schemes for additional polarizations to match harness connector color-coding scheme for visual aid in assembly
- Modular-housing design with standard dovetail features molded into the housings allows headers to be ganged together in large assemblies to meet growing terminal quantity requirements

Reference Information

Packaging: Male Vertical Headers—Tray or Tube
Mates With: Series 34729 female connectors
Designed In: Millimeters

Electrical

Voltage: 500V max.
Current: 0.64mm (.025")—8.0A max.
Dielectric Withstanding Voltage: 500V DC
Isolation Resistance: 20 Megohms min.

Mechanical

Durability: 10 milliohms max.—10 cycles
Header Pin Retention Force:
0.64mm (.025")—15N (3.4 lb) min.

Physical

Header Housings: Glass filled SPS
Contact: 0.64mm (.025") pins—Copper Alloy
Plating:
0.64mm (.110") signal pins: Overplating—Tin
Underplating—Nickel

Circuit Size	Order No.	Polarization Option	Color
8	34690-0080	A	Black
	34690-0081	B	Grey
	34690-0082	C	Brown
12	34690-0120	A	Black
	34690-0121	B	Grey
	34690-0122	C	Brown
16	34690-0160	A	Black
	34690-0161	B	Grey
	34690-0162	C	Brown
20	34690-0200	A	Black
	34690-0201	B	Grey
	34690-0202	C	Brown
	34690-0203	D	Green

0.64mm (.025")

CTX64

Crimp Terminal

34803

Female

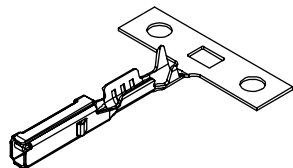
**Features and Benefits**

- Excellent stress-relaxation properties
- One-piece design to keep cost low
- Clean-body design to insert through matte seal
- Accommodates ISO/JASO and SAE wires
- Lead free
- Compatible to competitor's RH-terminal cavity
- Single polarization

Reference Information

Product Specification: PS-502306-001

Packaging: Reel

Mates With: 0.64mm wide by 0.64mm thick blade

Use With: 34729, 98833 and 502725

Designed In: Millimeters

Electrical

Voltage: 250V

Current: 7.0A

Contact Resistance: 5 milliohms max.

MechanicalWire Pull-Out Force: 0.85mm²—130N min.
0.22mm²—40N min

Mating Force: 4N max.

Unmating Force: 4N max.

Durability: 10 mates max.

Physical

Contact: Copper alloy

Plating: Contact Area—Tin

Solder Tail Area—Tin

Underplating—Nickel

Insulation Diameter: 1.9mm max.

Wire Gauge: 0.22 to 0.85mm²

Order No.		Polarization Option See Inset	Grip Code	Wire Gauge			Plating
D-Wind (Left Payoff)	B-Wind (Right Payoff)			ISO (mm ²)	JASO (mm ²)	SAE (gauge)	
34803-0211	34803-0213	Dual	S	0.22-0.35	0.3	22	Tin
34803-0212	34803-0214		L	0.50-0.75	0.50-0.85	20	

2.54mm (.100") Pitch

Stac64™

Signal Receptacle

34729

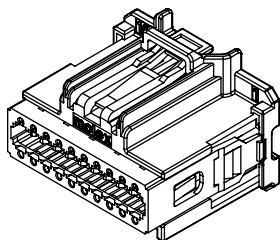
**Features and Benefits**

- Pre-assembled TPA to receptacle housing shipped as single assembly provide applied labor and cost savings

Reference Information

Packaging: Female Receptacle Connectors—Bulk Pack

Mates With: Series 34690, 34691 male unsealed headers

Use With Terminals:

0.64mm (.059") female—Series 502306

Designed In: Millimeters

Electrical

Voltage: 500V max.

Current: 0.64mm (.025")—8.0A max.

Contact Resistance: 0.64mm (.025")—20 milliohms max.

Dielectric Withstanding Voltage: 500V DC

Isolation Resistance: 20 Megohms min.

Mechanical

Connector Retention (Primary latch): 110N (24.7 lb) min.

Contact Retention to Housing:

0.64mm (.025")—75N (16.9 lb) min. with TPA,

30N (6.7 lb) without TPA

Contact Insertion Force Into Housing: 30N (6.7 lb) max.

Connector Audible Feedback: 7dB over ambient

Durability: 10 milliohms max.—10 cycles

TPA Insertion Force: 60N (13.5 lb) max.

TPA Extraction Force: 60N (13.5 lb) max.

Thermal Shock (Class 2, 100 cycles):

0.64mm (.025")—20 milliohms max.

Vibration/Mechanical Shock (electrical):

0.64mm (.025")—20 milliohms max.

Temperature/Humidity (electrical):

0.64mm (.025")—20 milliohms max.

High Temperature Exposure (electrical):

0.64mm (.025")—20 milliohms max.

Physical

Harness Housings: Glass filled SPS/nylon blend

TPA: 15% glass filled polyester

Circuit Size	Order No.	Polarization Option	Color	Assembly Features	Comment
8	34729-0080	A	Black	Housing and TPA Assembly	0.64mm (.025") terminal size USCAR receptacle connectors
	34729-0081	B	Grey		
	34729-0082	C	Brown		
12	34729-0120	A	Black		
	34729-0121	B	Grey		
	34729-0122	C	Brown		
16	34729-0160	A	Black		
	34729-0161	B	Grey		
	34729-0162	C	Brown		
20	34729-0200	A	Black		
	34729-0201	B	Grey		
	34729-0202	C	Brown		
	34729-0203	D	Green		

Power Stac Stac64™ Header

34696 Right Angle Single-Bay Hybrid

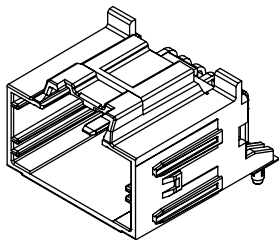

Features and Benefits

- PCB alignment posts ensure all terminals are properly aligned into PCB through-holes during assembly and retain header to PCB during assembly and solder processing
- PCB stand-offs molded into housings provide additional trace-routing real estate under the headers
- High temperature thermoplastic housings withstand infra red (IR) and wave lead-free solder processing per ES-40000-5013 Molex specification
- Stackable connection system of readily available PCB headers ensure reduced time-to-market: engineering and validation times reduced significantly, no tooling necessary to produce custom multi-bay headers
- The header housings are molded in standard USCAR color schemes for additional polarizations to match harness connector color-coding scheme for visual aid in assembly
- Modular-housing design with standard dovetail features molded into the housings allows headers to be ganged together in large assemblies to meet growing terminal quantity requirements

Reference Information

Packaging: Male Headers—Tray or Tube
Mates With: Series 31372 female connectors
Designed In: Millimeters

Electrical

Voltage: 500V max.
Current: 2.80mm (.110")—30.0A max.
1.50mm (.059")—18.0A max.
Dielectric Withstanding Voltage: 500V DC
Isolation Resistance: 20 Megohms min.
Polarization Feature Effectiveness: 220N (49.5 lb) min.
Durability: 10 millionohms max.—10 cycles
Header Pin retention Force:
2.80mm (.110")—70N (15.7 lb) min.
1.50mm (.059")—70N (15.7 lb) min.

Physical

Header Housings: Glass filled SPS
Contact:
2.80mm (.110") blades—Copper Alloy
1.50mm (.059") blades—Copper Alloy
Plating: 1.50mm (.059") blades:
Overplating—Tin
Underplating—Nickel
2.80mm (.110") blades: Overplating—Tin
Underplating—Nickel

Circuit Size	Order No.	Polarization Option	Color	Packaging	Assembly Features	Headers
10	34695-0100	A	Black	Tray	Housing and Blades Assembly	Power
	34695-0101	B	Grey			
	34695-9100	A	Black	Tube		
	34695-9101	B	Grey			

2.54mm (.100") Pitch Stac64™ Header

34691 Right Angle Single-Bay

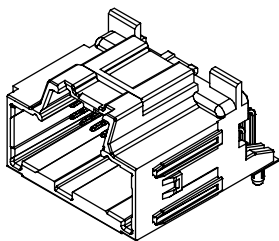

Features and Benefits

- PCB alignment posts ensure all terminals are properly aligned into PCB through-holes during assembly and retain header to PCB during assembly and solder processing
- PCB stand-offs molded into housings provide additional trace-routing real estate under the headers
- High temperature thermoplastic housings withstand infra red (IR) and wave lead-free solder processing per ES-40000-5013 Molex specification
- Stackable connection system of readily available PCB headers ensure reduced time-to-market: engineering and validation times reduced significantly, no tooling necessary to produce custom multi-bay headers
- The header housings are molded in standard USCAR color schemes for additional polarizations to match harness connector color-coding scheme for visual aid in assembly
- Modular-housing design with standard dovetail features molded into the housings allows headers to be ganged together in large assemblies to meet growing terminal quantity requirements

Reference Information

Packaging: Male Vertical Headers—Tray
Mates With: Series 34729 female connectors
Designed In: Millimeters

Electrical

Voltage: 500V max.
Current: 0.64mm (.025")—8.0A max.
Dielectric Withstanding Voltage: 500V DC
Isolation Resistance: 20 Megohms min.

Mechanical

Durability: 10 millionohms max.—10 cycles
Header Pin retention Force:
0.64mm (.025")—15N (3.4 lb) min.

Physical

Header Housings: Glass filled SPS
Contact: 0.64mm (.025") pins—Copper Alloy
Plating: 0.64mm (.110") signal pins:
Overplating—Tin
Underplating—Nickel

Circuit Size	Order No.	Polarization Option	Color
8	34691-0080	A	Black
	34691-0081	B	Grey
	34691-0082	C	Brown
12	34691-0120	A	Black
	34691-0121	B	Grey
	34691-0122	C	Brown
16	34691-0160	A	Black
	34691-0161	B	Grey
	34691-0162	C	Brown
20	34691-0200	A	Black
	34691-0201	B	Grey
	34691-0202	C	Brown
	34691-0203	D	Green

Power Stac Stac64™ Hybrid Receptacle 31372

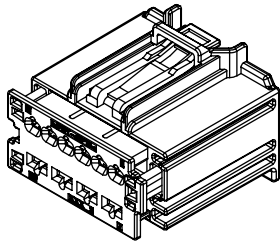

Features and Benefits

- Pre-assembled TPA to receptacle housing shipped as single assembly provide applied labor and cost savings

Reference Information

Packaging: Female Receptacle Connectors—Bulk Pack

Male Vertical Headers—Tray

Mates With: Series 34695, 34696 male unsealed headers

Use With Terminals:

1.50mm (.059") female—Molex 33012-2001, -2002, -2003

2.80mm (.110") female—Tyco and Yazaki

Tooling: Molex and Tyco Electronics

Designed In: Millimeters

Electrical

Voltage: 500V max.

Current: 2.80mm (.110")—30.0A max.

1.50mm (.059")—18.0A max.

Contact Resistance: 2.80mm (.110")—5 milliohms max.

1.50mm (.059")—10 milliohms max.

Dielectric Withstanding Voltage: 500V DC

Isolation Resistance: 20 Megohms min.

Mechanical

Mating Force: Less than 75N (16.9 lb)

Unmating Force: Less than 75N (19.1 lb)

Connector Retention (Primary latch): 110N (24.7 lb) min.

Contact Retention to Housing: 2.80mm (.110")—90N

(20.2 lb) min. with TPA, 60N (13.5 lb) without TPA

1.50mm (.059")—85N (19.1 lb) min. with TPA,

45N (10.1 lb) without TPA

Contact Insertion Force Into Housing: 30N (6.7 lb) max.

Connector Audible Feedback: 7dB over ambient

Durability: 10 milliohms max.—10 cycles

TPA Insertion Force: 60N (13.5 lb) max.

TPA Extraction Force: 60N (13.5 lb) max.

Thermal Shock (Class 2, 100 cycles):

2.80mm (.110")—5 milliohms max.

1.50mm (.059")—10 milliohms max.

Vibration/Mechanical Shock (electrical):

2.80mm (.110")—5 milliohms max.

1.50mm (.059")—10 milliohms max.

Temperature/Humidity (electrical):

2.80mm (.110")—5 milliohms max.

1.50mm (.059")—10 milliohms max.

High Temperature Exposure (electrical):

2.80mm (.110")—5 milliohms max.

1.50mm (.059")—10 milliohms max.

Physical

Harness Housings: glass filled SPS/nylon blend

TPA: 15% glass filled polyester

Contact:

2.80mm (.110") blades—Copper Alloy

1.50mm (.059") blades—Copper Alloy

Plating: 1.50mm (.059") blades:

Overplating—Tin

Underplating—Nickel 1.50mm (.059")

Receptacle Terminals: Overplating—Tin

Underplating—Nickel

2.80mm (.110") blades: Overplating—Tin

Underplating—Nickel

Circuit Size	Order No.	Polarization Option	Color	Comment
10	31372-1000	A	Black	1.50 and 2.80mm (.059 and .110") terminal size hybrid receptacle connectors
	31372-1001	B	Grey	

Stac64™ Header

34707 Vertical Ganged Multi-Bay

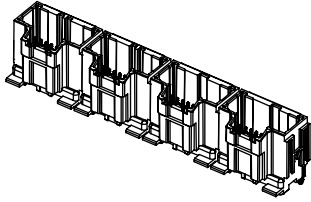

Features and Benefits

- PCB alignment posts ensure all terminals are properly aligned into PCB through-holes during assembly and retain header to PCB during assembly and solder processing
- High temperature thermoplastic housings withstand infra red (IR) and wave lead-free solder processing per ES-40000-5013 Molex specification
- Stackable connection system of readily available PCB headers ensure reduced time-to-market: engineering and validation times reduced significantly, no tooling necessary to produce custom multi-bay headers
- The header housings are molded in standard USCAR color schemes for additional polarizations to match harness connector color-coding scheme for visual aid in assembly
- Modular-housing design with standard dovetail features molded into the housings allows headers to be ganged together in large assemblies to meet growing terminal quantity requirements

Reference Information

Packaging: Male Headers—Tray or Tube
Mates With: Series 34729 and 31372 female connectors
Designed In: Millimeters

Electrical

Voltage: 500V max.
Current: 2.80mm (.110")—30.0A max.
1.50mm (.059")—18.0A max.
0.64mm (.025")—8.0A max.
Dielectric Withstanding Voltage: 500V DC
Isolation Resistance: 20 Megohms min.

Mechanical

Durability: 10 milliohms max.—10 cycles
Header Pin retention Force:
2.80mm (.110")—70N (15.7 lb) min.
1.50mm (.059")—70N (15.7 lb) min.
0.64mm (.025")—15N (3.4 lb) min.

Physical

Header Housings: Glass filled SPS
Contact:
2.80mm (.110") blades—Copper Alloy
1.50mm (.059") blades—Copper Alloy
0.64mm (.025") pins—Copper Alloy
Plating: 0.64mm (.110") signal pins:
Overplating—Tin
Underplating—Nickel
1.50mm (.059") blades: Overplating—Tin
Underplating—Nickel
2.80mm (.110") blades: Overplating—Tin
Underplating—Nickel

Order No.	No. of Bays	Circuit Sizes by Bay	Assembly Features	Headers
34707-2000	2	20 by 20	Housing and Pins Assembly	Signal
34707-2002		10 by 20	Housing, Pins and Blades Assembly	Signal and Power
34707-2012		20 by 10	Housing and Blades Assembly	
34707-2022		10 by 10	Housing, Pins and Blades Assembly	Power
34707-2030	4	20 by 20 by 20 by 20	Housing and Pins Assembly	Dense Signal
34707-4000				

Note: Other configurations available, contact Molex

Stac64™ Header

34708 Right Angle Ganged Multi-Bay

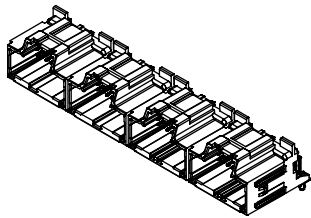

Features and Benefits

- PCB alignment posts ensure all terminals are properly aligned into PCB through-holes during assembly and retain header to PCB during assembly and solder processing
- High temperature thermoplastic housings withstand infra red (IR) and wave lead-free solder processing per ES-40000-5013 Molex specification
- Stackable connection system of readily available PCB headers ensure reduced time-to-market: engineering and validation times reduced significantly, no tooling necessary to produce custom multi-bay headers
- The header housings are molded in standard USCAR color schemes for additional polarizations to match harness connector color-coding scheme for visual aid in assembly
- Modular-housing design with standard dovetail features molded into the housings allows headers to be ganged together in large assemblies to meet growing terminal quantity requirements

Reference Information

Packaging: Male Headers—Tray or Tube
 Mates With: Series 34729 and 31372 female connectors
 Designed In: Millimeters

Electrical

Voltage: 500V max.
 Current: 2.80mm (.110")—30.0A max.
 1.50mm (.059")—18.0A max.
 0.64mm (.025")—8.0A max.
 Dielectric Withstanding Voltage: 500V DC
 Isolation Resistance: 20 Megohms min.

Mechanical

Durability: 10 milliohms max.—10 cycles
 Header Pin Retention Force:
 2.80mm (.110")—70N (15.7 lb) min.
 1.50mm (.059")—70N (15.7 lb) min.
 0.64mm (.025")—15N (3.4 lb) min.

Physical

Header Housings: Glass filled SPS
 Contact:
 2.80mm (.110") blades—Copper Alloy
 1.50mm (.059") blades—Copper Alloy
 0.64mm (.025") pins—Copper Alloy
 Plating: 0.64mm (.110") signal pins:
 Overplating—Tin
 Underplating—Nickel
 1.50mm (.059") blades: Overplating—Tin
 Underplating—Nickel
 2.80mm (.110") blades: Overplating—Tin
 Underplating—Nickel

Order No.	No. of Bays	Circuit Sizes by Bay	Assembly Features	Headers
34708-2000	2	20 by 20	Housing, Blades and Mylar Assembly	Signal
34708-2012		10 by 20	Housing, Pins, Blades and Mylar Assembly	Signal and Power
34708-2022		20 by 10		
34708-2030		10 by 10	Housing, Blades and Mylar Assembly	Power
34708-4000	4	20 by 20 by 20 by 20	Housing, Pins and Mylar Assembly	Dense Signal

Note: Other configurations available, contact Molex

2.54mm (.100") Pitch H-DAC 64™ Male Plug

31067/31068/31072/ 31073 Single Row

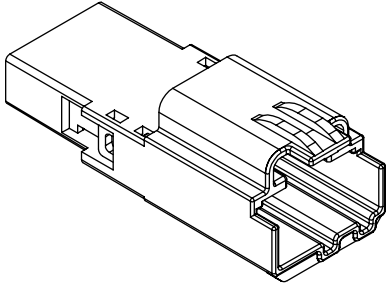

Features and Benefits

- Versatile product selection
- Scoop-proof housing
- Three standard polarizations
- TPA feature
- Positive-lock provides audible click
- Optional clip slot feature

Reference Information

Product Specifications: PS-31067-0001 (single row)
PS-31101-0001 (headers)

Packaging: Bulk

Mates With:

Male and Female

Single Row—31067, 31068, 31072 and 31073

Headers—31100 and 31101

Use With: Industry approved male and female terminals

Designed In: Millimeters

Electrical

Voltage: 500V

Current: 10A

Contact Resistance: 20 milliohms max.

Dielectric Withstanding Voltage: 500V DC

Insulation Resistance: 20 Megohms min.

Mechanical

Contact Insertion Force: 30N (6.7 lb)

Contact Retention to Housing: 30N (6.7 lb)

Mating Force: 45N (10.1 lb)

Unmating Force: 45N (10.1 lb)

Durability: 10 cycles

Physical

Housing: Glass filled SPS

Contact: Copper Alloy

Plating: Overplating—Tin

Underplating—Nickel

Circuits	Order No.	Polarization	Options	Lead-free
3	31067-1040	A	christmas tree attachment	Yes
	31067-1041	B		
	31067-1042	C		
	31067-1070	A		
	31067-1071	B		
	31067-1072	C		
4	31068-1040	A	christmas tree attachment	Yes
	31068-1041	B		
	31068-1042	C		
	31068-1070	A		
	31068-1071	B		
	31068-1072	C		

Circuits	Order No.	Polarization	Options	Lead-free
5	31072-1040	A	christmas tree attachment	Yes
	31072-1041	B		
	31072-1042	C		
	31072-1070	A		
	31072-1071	B		
	31072-1072	C		
6	31073-1040	A	christmas tree attachment	Yes
	31073-1041	B		
	31073-1042	C		
	31073-1070	A		
	31073-1071	B		
	31073-1072	C		

2.54mm (.100") Pitch H-DAC 64™ Female Receptacle

31067/31068/31072/31073 Single Row

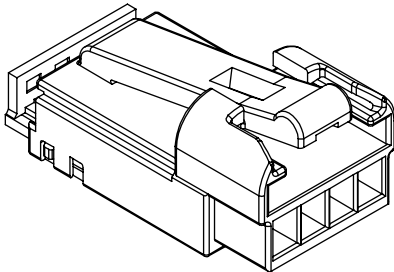

Features and Benefits

- Versatile product selection
- Scoop-proof housing
- Three standard polarizations
- TPA feature
- Positive-lock provides audible click
- Optional clip slot feature

Reference Information

Product Specifications: PS-31067-0001 (single row)
PS-31101-0001 (headers)

Packaging: Bulk

Mates With:

Male and Female

Single Row—31067, 31068, 31072 and 31073

Headers—31100 and 31101

Use With: Industry approved male and female terminals

Designed In: Millimeters

Electrical

Voltage: 500V

Current: 10A

Contact Resistance: 20 milliohms max.

Dielectric Withstanding Voltage: 500V DC

Insulation Resistance: 20 Megohms min.

Mechanical

Contact Insertion Force: 30N (6.7 lb)

Contact Retention to Housing: 30N (6.7 lb)

Mating Force: 45N (10.1 lb)

Unmating Force: 45N (10.1 lb)

Durability: 10 cycles

Physical

Housing: Glass filled SPS

Contact: Copper Alloy

Plating: Overplating—Tin

Underplating—Nickel

Circuits	Order No.	Polarization	Lead-free
3	31067-1010	A	Yes
	31067-1011	B	
	31067-1012	C	
4	31068-1010	A	Yes
	31068-1011	B	
	31068-1012	C	

Circuits	Order No.	Polarization	Lead-free
5	31072-1010	A	Yes
	31072-1011	B	
	31072-1012	C	
6	31073-1010	A	Yes
	31073-1011	B	
	31073-1012	C	

2.54mm (.100") Pitch H-DAC 64™ Header

31101 Vertical Single Row

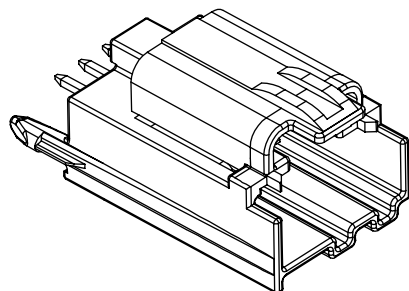

Features and Benefits

- Versatile product selection
- Scoop-proof housing
- Three standard polarizations in 3 colors
- TPA feature
- Positive-lock provides audible click
- Optional clip slot feature

Reference Information

Product Specifications: PS-31067-0001 (single row)
PS-31101-0001 (headers)

Packaging: Bag

Mates With:

Male and Female

Single Row—31067, 31068, 31072 and 31073

Headers—31100 and 31101

Use With: Industry approved male and female terminals

Designed In: Millimeters

Electrical

Voltage: 500V

Current: 10A

Contact Resistance: 20 milliohms max.

Dielectric Withstanding Voltage: 500V DC

Insulation Resistance: 20 Megohms min.

Mechanical

Contact Insertion Force: 30N (6.7 lb)

Contact Retention to Housing: 30N (6.7 lb)

Mating Force: 45N (10.1 lb)

Unmating Force: 45N (10.1 lb)

Durability: 10 cycles

Physical

Housing: Glass filled SPS

Contact: Copper Alloy

Plating: Overplating—Tin

Underplating—Nickel

Circuits	Order No.	Polarization	Options	Lead-free
4	31101-0040	A	PCB Retention Pegs	Yes
	31101-0041	B		
	31101-0042	C		
	31101-1140	A	Wings	
	31101-1240	B		
	31101-1340	C		

2.54mm (.100") Pitch H-DAC 64™ Header

31100 Right Angle Single Row

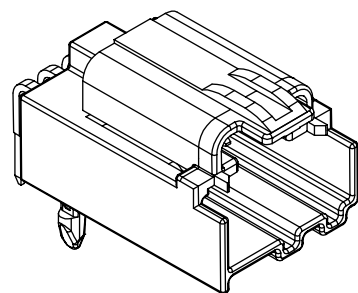

Features and Benefits

- Versatile product selection
- Scoop-proof housing
- Three standard polarizations in three colors
- TPA feature
- Positive-lock provides audible click
- Optional clip slot feature

Reference Information

Product Specifications: PS-31067-0001 (single row)
PS-31101-0001 (headers)

Packaging: Bag

Mates With:

Male and Female

Single Row—31067, 31068, 31072 and 31073

Headers—31100 and 31101

Use With: Industry approved male and female terminals

Designed In: Millimeters

Electrical

Voltage: 500V

Current: 10A

Contact Resistance: 20 milliohms max.

Dielectric Withstanding Voltage: 500V DC

Insulation Resistance: 20 Megohms min.

Mechanical

Contact Insertion Force: 30N (6.7 lb)

Contact Retention to Housing: 30N (6.7 lb)

Mating Force: 45N (10.1 lb)

Unmating Force: 45N (10.1 lb)

Durability: 10 cycles

Physical

Housing: Glass filled SPS

Contact: Copper Alloy

Plating: Overplating—Tin

Underplating—Nickel

Circuits	Order No.	Polarization	Lead-free
4	31100-0040	A	Yes
	31100-0041	B	
	31100-0042	C	

H-DAC 64™ Female Receptacle

30700
Hybrid

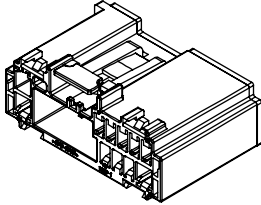

Features and Benefits

- Versatile product selection
- Scoop-proof housing
- Two standard polarizations in two colors
- TPA feature
- Positive-lock provides audible click

Reference Information

Product Specifications: PS-30968-0240
 Packaging: Bulk
 Mates With:
 Male In-line Connectors—30968
 Vertical and Right Angle Headers—30700
 Use With: Industry approved female 0.64, 1.50, 2.80 crimp terminals
 Designed In: Millimeters

Electrical

Voltage: 500V
 Current: 0.64 = 11.0A max., 1.50 = 18.0A max.,
 2.80 = 21.0A max.
 Contact Resistance: 20 milliohms max.
 Dielectric Withstanding Voltage: 500V DC
 Isolation Resistance: 20 Megohms min.

Physical

Housing: Glass filled SPS
 TPA: Glass filled PBT

Circuits	Order No.	Polarization	Lead-free
24	30700-1244	A	Yes
	30700-1245	B	

H-DAC 64™ Male In-line Connector

30968
Hybrid

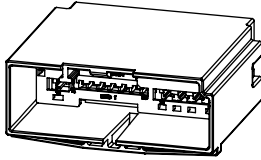

Features and Benefits

- Versatile product selection
- Scoop-proof housing
- Two standard polarizations in two colors
- TPA feature
- Positive-lock provides audible click
- Clip slot feature

Reference Information

Product Specifications: PS-30968-0240
 Packaging: Bulk
 Mates With: Female Receptacle—30700
 Use With: Industry approved male 0.64, 1.50, 2.80 crimp terminals
 Designed In: Millimeters

Electrical

Voltage: 500V
 Current: 0.64 = 11.0A max., 1.50 = 18.0A max.,
 2.80 = 21.0A max.
 Contact Resistance: 20 milliohms max.
 Dielectric Withstanding Voltage: 500V DC
 Isolation Resistance: 20 Megohms min.

Physical

Housing: Glass filled SPS
 TPA: Glass filled PBT

Circuits	Order No.	Polarization	Options	Lead-free
24	30968-1247	A	Clip slot attachment	Yes
	30968-1248	B		

H-DAC 64™

Header

30700

Vertical Hybrid

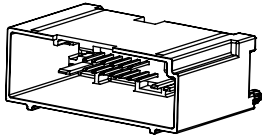

Features and Benefits

- Versatile product selection
- Scoop-proof housing
- Two standard polarizations in two colors

Reference Information

Product Specifications: PS-30700-0240
 Mates With: Female Receptacle—30700
 Use With: Industry approved 0.64, 1.50, 2.80 female crimp terminals
 Designed In: Millimeters

Electrical

Voltage: 500V
 Current: 0.64 = 11.0A max., 1.50 = 18.0A max.,
 2.80 = 21.0A max.
 Contact Resistance: 20 milliohms max.
 Dielectric Withstanding Voltage: 500V DC
 Isolation Resistance: 20 Megohms min.

Physical

Housing: Glass filled SPS
 Lead-free reflow compatible up to 260°C
 Contact: Copper Alloy
 Plating: Overplating—Tin
 Underplating—Nickel

Circuits	Order No.	Polarization	Packaging	Lead-free
24	30700-4240	A	Tray	Yes
	30700-4241	B		
	30700-4244	A	Tube	
	30700-4245	B		

H-DAC 64™

Header

30700

Right Angle Hybrid

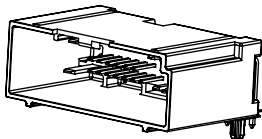

Features and Benefits

- Versatile product selection
- Scoop-proof housing
- Two standard polarizations in two colors

Reference Information

Product Specifications: PS-30700-0240
 Mates With: Female Receptacle—30700
 Use With: Industry approved 0.64, 1.50, 2.80 female crimp terminals
 Designed In: Millimeters

Electrical

Voltage: 500V
 Current: 0.64 = 11.0A max., 1.50 = 18.0A max.,
 2.80 = 21.0A max.
 Contact Resistance: 20 milliohms max.
 Dielectric Withstanding Voltage: 500V DC
 Isolation Resistance: 20 Megohms min.

Physical

Housing: Glass filled SPS
 Lead-free reflow compatible up to 260°C
 Contact: Copper Alloy
 Plating: Overplating—Tin
 Underplating—Nickel

Circuits	Order No.	Polarization	Packaging	Lead-free
24	30700-5240	A	Tray	Yes
	30700-5241	B		
	30700-5244	A	Tube	
	30700-5245	B		

2.54mm (.100") Pitch MOX Crimp Terminal

98658
Female

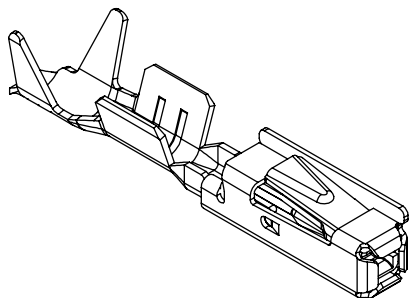

Features and Benefits

- Two-piece laser-welded terminal
- Two points of contact
- For wire termination
- Two-piece terminal with sleeve design
- Steel sleeve protects mating area
- Polarization rib for terminal orientation during assembly
- Long contact area provides secure electrical connection

Reference Information

Product Specification: PS-98658-005

Packaging: Reel

Mates With: 0.635mm (.025") square pin terminals

Use With: MOX housings and various other connectors

Designed In: Millimeters

Electrical

Voltage: 14V DC

Current: 6.5A

Contact Resistance: 8 milliohms max.

Dielectric Withstanding Voltage: 1000V AC

Insulation Resistance: 100 Megohms min.

Mechanical

Contact Insertion Force: 3.0N max.

Contact Retention to Housing: 40.0N min.

Wire Pull-Out Force: 50N min. on 0.22mm² wire

Insertion Force to Housing: 5.0N max. (for unsealed);

10.0N max. (for sealed connector)

Durability: 20 cycles

Physical

Contact: High Conductive Copper Alloy, 0.635mm (.025"), square

Plating: Pre-plated

Contact Area: Tin—1 to 3μm min.; Gold—0.4μm min.

Underplating: Nickel (for Gold-plated version only)

Order No.	Plating	Wire Size (AWG)	Wire size (mm ²)	Wire Insulation Diameter	Wire Strip Length	Lead-free
98658-1211	Tin	20-24	0.22-0.60	1.20-1.80mm (.047-.071")	3.00mm	Yes
98658-1212		18-22	0.75	1.70mm (.067") max	3.50mm	
98658-1213		20-24	0.22-0.50	1.20-1.50mm (.047-.060")	3.00mm	
98658-1221	Select Gold	20-24	0.22-0.60	1.20-1.80mm (.047-.071")	3.00mm	
98658-1222		18-22	0.75	1.70mm (.067") max	3.50mm	
98658-1223		20-24	0.22-0.50	1.20-1.50mm (.047-.060")	3.00mm	
98658-1231	2 points Select Gold	20-24	0.22-0.60	1.20-1.80mm (.047-.071")	3.00mm	
98658-1232		18-22	0.75	1.70mm (.067") max	3.50mm	
98658-1233		20-24	0.22-0.50	1.20-1.50mm (.047-.060")	3.00mm	

2.54mm (.100") Pitch MOX Receptacle Housing

98193
Single Row, Vertical
With TPA

Features and Benefits

- Reusable one-piece secondary locking
- Inertial locking feature
- One-piece design with integrated secondary lock for easy use

Reference Information

Packaging: Bag

Use With: 98658

Designed In: Millimeters

Electrical

Voltage: 14V DC

Current: 6.0A

Contact Resistance: 8 milliohms max.

Dielectric Withstanding Voltage: 1000V AC

Insulation Resistance: 100 Megohms min.

Mechanical

Contact Insertion Force: 5.0N (1.12 lb) max.

Contact Retention to Housing: 40.0N (9 lb) min.

Wire Pull-Out Force: 100.0N (22.5 lb) min.

Mating Force: 60.0N (13.5 lb) max.

Unmating Force: 60.0N (13.5 lb) max.

Durability: 20 cycles (with Tin-plated terminal)

Physical

Housing: Black PA Polyamide (nylon) 6, UL 94V-2

Circuits	Order No.	Lead-free
6	98193-0001	Yes

2.54mm (.100") Pitch MOX Receptacle Housing

98298

**2 by 3 Circuits
Dual Row, Vertical
Breakable**

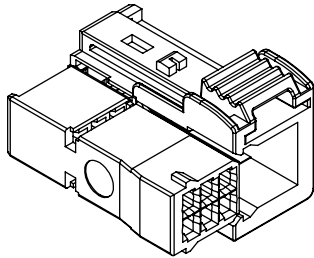

Features and Benefits

- Reusable two-piece secondary locking feature
- Inertial locking feature
- Six color and mechanical codings
- One-piece design with integrated secondary lock for easy use

Reference Information

Packaging: Bag
Mates With: Industry-standard interface
Use With: 98658
Designed In: Millimeters

Electrical

Voltage: 14V DC
Current: 6.0A
Contact Resistance: 8 milliohms max.
Dielectric Withstanding Voltage: 1000V AC
Insulation Resistance: 100 Megohms min.

Mechanical

Contact Insertion Force: 5.0N (1.12 lb) max.
Contact Retention to Housing: 40.0N (9 lb) min.
Wire Pull-Out Force: 100N (22.5 lb) min.
Mating Force: 65.0N (14.6 lb) max.
Unmating Force: 60.0N (13.5 lb) max.
Durability: 20 cycles (with Tin-plated terminals)

Physical

Housing: Glass-filled PBT Polyester, HB, UL 94-HB

Circuits	Order No.	Color	Lead-free
6	98298-0001	Black	Yes
	98298-0002	White	
	98298-0003	Green	
	98298-0004	Brown	
	98298-0005	Gray	
	98298-0006	Blue	

www.molex.com/product/mox.html

2.54x2.54mm (.100"x.100") Pitch MOX Receptacle Housing

94552

**Dual Row, Breakable
8/12 Circuits**

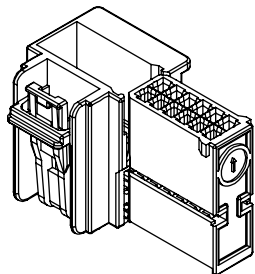

Features and Benefits

- One-piece housing and secondary locking
- Breakable configuration
- Ease of use
- MQS compatible
- According to USCAR standard

Reference Information

Packaging: PK-94552-001
Mates With: 31341 series
Use With: 98658 series terminals
Designed In: Millimeters

Electrical

Voltage: 125 V RMS
Current: 7.5A max.
Contact Resistance: 7 milliohms max.
Dielectric Withstanding Voltage: 1000 V max.
Insulation Resistance: 10 Megohms min.

Mechanical

Contact Insertion Force into Housing: 15N (3.4 lb) max.
Contact Retention to Housing: 60N (13.5 lb) max.
Wire Pull-Out Force: 50N min.
Mating Force: 75N min.
Unmating Force: 75N min.
Durability: 20 cycles

Physical

Housing: PBT 20% G.F.

Circuits	Order No.	Polarization	Lead-Free
8	94552-9008	B	Yes
12	94552-9012	A	

2.54mm (.100") Pitch MOX Receptacle Housing

98615 Dual Row, 64 Circuits

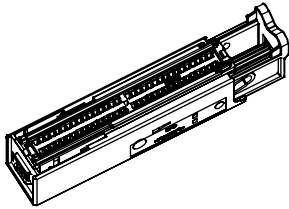

Order No.	Version	Lead-Free
98615-1001	Flex	Yes
98615-1002	Wire	

Features and Benefits

- Slide locking assistance
- Design compatible with wire version (0986151002) or FFC version (0986151001)
- Wire cap available
- Secondary locking

Reference Information

Packaging: Tray
 Mates With: 98317, 98599 and 98580
 Use With: 98658 (wire terminal) or 98194 (FFC terminal)
 Designed In: Millimeters

Electrical

Voltage: 14V DC
 Current: 6.0A max.
 Contact Resistance: 8 milliohms max.
 Dielectric Withstanding Voltage: 1000V AC
 Insulation Resistance: 100 Megohms min.

Mechanical

Contact Insertion Force: 5.0N (1.12 lb) max.
 Contact Retention to Housing (TPA inactive):
 40.0N (9 lb) min.
 Wire Pull-Out Force: 100N (22.5 lb) min.
 Mating Force: 80.0N (18.0 lb) max.
 Unmating Force: 80.0N (18.0 lb) max.
 Durability: 20 cycles (with Gold/Tin plated terminals)

Physical

Housing: PBT Polyester, Glass-filled, UL 94-HB

www.molex.com/mox.html

2.54mm (.100") Pitch MOX Header

98599 Dual Row, 64 Circuits

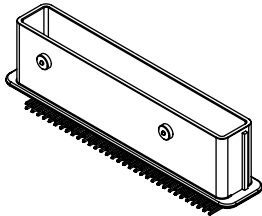

Order No.	Product Attribute	Color
98599-1002	60 way	Black
98599-1003	44 way	
98599-1004	64 way	

Features and Benefits

- Wire-to-board connector in a right-angle configuration
- Suitable for all body, safety and comfort-and-convenience applications

Reference Information

Packaging: Tray
 Mates With: 98615
 Designed In: Millimeters

Electrical

Voltage: 14V DC max.
 Current: 6.0A max.
 Contact Resistance: 8 milliohms max.
 Dielectric Withstanding Voltage: 1000V AC
 Insulation Resistance: 100 Megaohms min.

Mechanical

Contact Retention to Housing: 25.0N min.
 Mating Force: 80.0N (18.0 lb) max. in use with 98615
 Unmating Force: 80.0N (18.0 lb) max. in use with 98615
 Durability: 20 cycles min.

Physical

Housing: PBT glass-filled Polyester
 Contact: C 51900
 Plating: Contact Area—0.3µm gold
 Solder Tail Area—3 to 5µm Tin
 Underplating—1µm nickel min.
 PCB Thickness: 1.60mm
 Insulation Diameter: 1.90mm max.

2.54mm (.100") Pitch MOST Receptacle Housing

98684

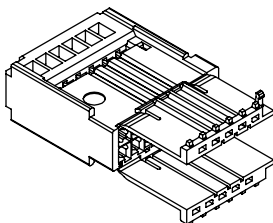

Circuits	Order No.	Color Coding	Key	Lead-free
12	98684-0001	Black	Key A	Yes
	98684-0002	Natural	Key B	

Features and Benefits

- TPA integrated by filme hinge function
- Fits into 98681-1001 and 98681-1002
- Keying prevents wrong insertion into housing frame
- Terminal cavities designed for Molex MOX 0.64mm (.025") terminals
- Conforms to USCAR-2 Rev. 3

Reference Information

Product Specification: PS-98681-001
 Packaging: Box
 Mates With: 91500, 91547, 98681
 Use With: 98658

Electrical

Voltage: 9 to 16V DC (operating normal)
 Current: 7.5A max.
 Contact Resistance: 100 milliohms max.

Mechanical

Contact Insertion Force: 30.00N (6.74 lb)
 Contact Retention to Housing: 60.00N (13.49 lb)
 Mating Force: 75.00N (16.86 lb)
 Unmating Force: 75.00N (16.86 lb)
 Durability: 11 mating cycles

Physical

Housing: PBT Polyester, UL 94-HB

2.54mm (.100") Pitch MOST Junction Box

91616
Vertical, without 10.0A Fuse

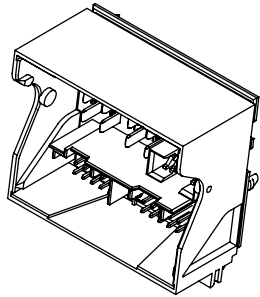

Circuits	Order No.	Lead-free
40	91616-0001	Yes

Features and Benefits

- Complies with MOST specifications and is therefore a drop-in replacement part
- Fuse options available
- Mini-PCB assembly available
- Lead-free

Reference Information

Product Specification: PS-91616-001
Packaging: Tray
Designed In: Millimeters

Electrical

Voltage: 16V
Current: 6.0A
Contact Resistance: 10 milliohms max.
Dielectric Withstanding Voltage: 500V AC
Insulation Resistance: 500 Megohms min.

Mechanical

Insertion Force to PCB: 70.0N (15.74 lb)
Durability: 30 cycles

Physical

Housing: Glass-filled PA Polyamide (nylon), UL 94V-0
Contact: Copper Alloy
Plating: Contact Area—Tin
PCB Thickness: 1.6mm (0.62")

5.08mm (.200") Pitch MOST Frame Receptacle Housing

98681
With Lever,
40 Electrical and 4 Optical Circuits
(Optional)

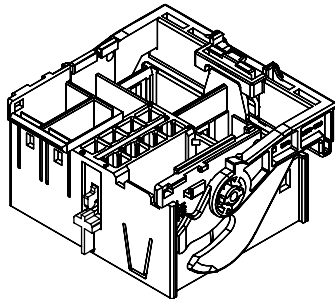

Order No.		Lead-free
With Cable Cover	Without Cable Cover	
98681-1001	98681-1002	Yes

Features and Benefits

- MOST corporation interface
- Plastic optical fiber option integrated
- Version with feature to receive wire cap/strain relief 98660-0001
- Conforms to USCAR-2 Rev. 3 and Ford SDS Rev. 10

Reference Information

Product Specification: PS-98681-001
Packaging: Box
Mates With: 91616, 91574
Use With: 98660, 98684, 98685
Designed In: Millimeters

Electrical

Voltage: 9 to 16V DC (operating normal)
Current: 24.0A max.
Contact Resistance: 5 milliohms max.

Mechanical

Contact Insertion Force: <30.00N (6.74 lb)
Contact Retention to Housing: >60.00N (13.49 lb)
Mating Force: 75.00N (16.86 lb)
Unmating Force: 75.00N (16.86 lb)
Durability: 11 mating cycles

Physical

Housing: Black glass-filled SPS/PA 6/6, UL 94-HB

5.08mm (.200") Pitch MOST Receptacle Power Connector 98685 With TPA Lock

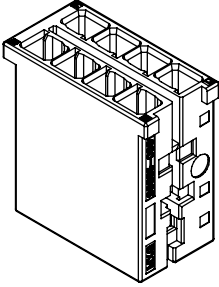

Features and Benefits

- Fits to MOST frame receptacle housing 98681-1001 and 98681-1002
- Delivered with Terminal Position Assurances (TPA) in pre-lock position
- Conforms to USCAR-2 Rev. 3 and Ford SDS Rev. 10

Reference Information

Product Specification: PS-98681-001
 Packaging: Box
 Mates With: 91500, 91547 and 98681
 Use With: 2.80mm (.110") MPQ terminals

Electrical

Voltage: 9 to 16V DC (operating normal)
 Current: 24.0A max.
 Contact Resistance: 5 milliohms max.

Mechanical

Contact Insertion Force: 30.00N (6.74 lb) min.
 Contact Retention to Housing: 60.00N (13.49 lb) max.
 Mating Force: 75.00N (16.86 lb)
 Unmating Force: 75.00N (16.86 lb)

Physical

Housing: Black glass-filled SPS Crystalline Polymer, UL 94-HB

Circuits	Order No.	Lead-free
8	98685-1001	Yes

5.08mm (.200") Pitch MOST Strain Relief Cable Cover 98660

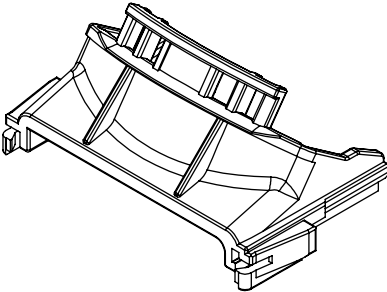

Features and Benefits

- Provides 45° wire
- Positive clip
- Conforms to USCAR-2 Rev. 3 and Ford SDS Rev. 10

Reference Information

Product Specification: PS-98681-001
 Packaging: Bag
 Use With: 98681-1001

Physical

Housing: Black PBT Polyester

Order No.	Lead-free
98660-0001	Yes

3.33mm (.131")/ 6.00mm (.236") Pitch NSCC Hybrid Inline Receptacle Housing

98273
Dual Row, Vertical with Slide

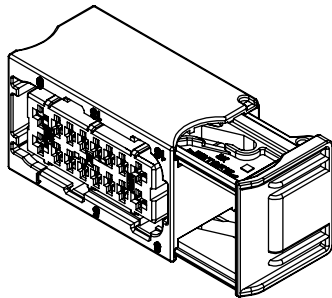

Features and Benefits

- Secondary locking for 1.54 and 2.8mm (.060 and .110") terminals
- Slide to reduce mating force
- Right slide orientation
- Hole feature to seal the slide in locked position
- Six mechanical codings correlating with 6 housing colors

Reference Information

Packaging: Box
Mates With: 98276
Use With: 98897 and 98898
Designed In: Millimeters

Electrical

Voltage: 13.5V
Current:
1. 50mm—7.0A max. at 85°C crimped on 2.0mm² wire
2. 80mm—15.0A max. at 85°C crimped on 4.0mm² wire
Dielectric Withstanding Voltage: 1000V min.
Insulation Resistance: 200 Megohms min.

Mechanical

Contact Insertion Force: 1.5mm (.060")—5.0N max.
2.8mm (.110")—8.0N max.
Contact Retention to Housing: 1.5mm (.060")—100.0N min.
2.8mm (.110")—100.0N min.
Mating Force: 60.0N max.
Unmating Force: 20.0N min.
Normal Force: 150.0N min.
Durability: 20 cycles

Physical

Housing: Glass-filled PBT Polyester, UL 94-HB

Circuits	Order No.	Color	Lead-free
16	98273-1001	Black	Yes
	98273-1002	Green	
	98273-1003	Blue	
	98273-1004	White	
	98273-1005	Brown	
	98273-1006	Gray	

3.33mm (.131")/ 6.00mm (.236") Pitch NSCC Hybrid Inline Plug Housing

98276
Dual Row, Vertical

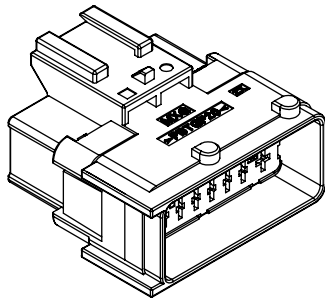

Features and Benefits

- Secondary locking for 1.5 and 2.8mm (.060 and .110") terminals
- Six mechanical codings correlating with 6 housing colors
- Clip feature for standard fir tree clip

Reference Information

Packaging: Box
Mates With: 98273
Use With: 1.5 and 2.8mm blade terminals
Designed In: Millimeters

Electrical

Voltage: 13.5V
Dielectric Withstanding Voltage: 1000V min.
Insulation Resistance: 200 Megohms min.

Mechanical

Contact Insertion Force: 1.5mm (.060")—5.0N max.
2.8mm (.110")—8.0N max.
Contact Retention to Housing: 1.5mm (.060")—100.0N min.
2.8mm (.110")—100.0N min.
Mating Force: 60.0N max.
Unmating Force: 20.0N min.
Normal Force: 150N min.
Durability: 20 cycles

Physical

Housing: Glass-filled PBT Polyester, UL 94-HB

Circuits	Order No.	Color	Lead-free
16	98276-1001	Black	Yes
	98276-1002	Green	
	98276-1003	Blue	
	98276-1004	White	
	98276-1005	Brown	
	98276-1006	Gray	

5.00mm (.197") Pitch NSCC Wire-to-Board Receptacle Housing

98438

**Vertical, with Bridges
For 2.80mm (.110") Tab**

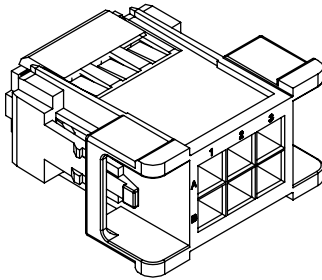

Features and Benefits

- Designed for 2.80mm (.110") terminals from Molex
- Secondary locking
- Six mechanical codings available
- Two bridges to avoid damaging of latches
- Unsealed connector system

Reference Information

Packaging: Box
Mates With: Any 2.80mm (.110") header
Use With: 98898 2.80mm (.110") UCC terminals
Designed In: Millimeters

Electrical

Current: 15.0A max. @ 85°C
Dielectric Withstanding Voltage: 1000V AC or 1400V DC
Insulation Resistance: 100 Megohms min.

Mechanical

Contact Insertion Force: 10.0N (2.25 lb) max.
Contact Retention to Housing: 80.0N (17.98 lb) min.
Mating Force: 60.0N (13.49 lb) max.
Unmating Force: 150.0N (33.72 lb) max.

Physical

Housing: PBT Polyester, UL 94-HB

Circuits	Order No.	Color	Lead-free
6	98438-1001	Natural	Yes
	98438-1002	Black	
	98438-1003	Gray	
	98438-1004	Blue	
	98438-1005	Brown	
	98438-1006	Red	

www.molex.com

4.00mm (.157") Pitch OBD-II Wire-to-Wire Terminal

50420

Female

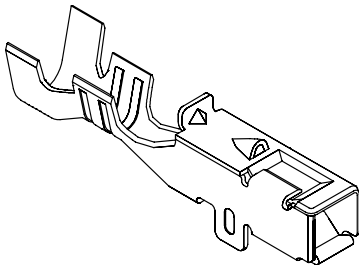

Features and Benefits

- Two-point contact design provides a redundant electrical interface
- Accepts retainer for additional terminal retention

Reference Information

Product Specification: PS-51115-001
Packaging: Reel
Mates With: 57964
Use With: 51115 and 51116
Designed In: Millimeters

Electrical

Voltage: 30V

Current:

Wire Size	Current
AVS.AVSS 0.3	4A
AVS.AVSS.CAVS 0.5	5A
AVS.AVSS.CAVS 0.85	6A

Contact Resistance: 100 milliohms max.
Dielectric Withstanding Voltage: 1000V AC
Insulation Resistance: 500V DC 100 Megohms min.

Physical

Contact: Phosphor Bronze
Plating: Tin
Insulation Diameter: 1.60 to 2.30mm (.024 to .091")

Order No.	Wire Range (mm ²)	Lead-free
50420-8000	AVS 0.3-0.5	Yes
	AVS 0.30f-0.75f	
	AVSS 0.50-0.85	
	AVSS 0.50f-0.75f	
	CAVS 0.50-0.85	

4.00mm (.157") Pitch OBD-II Wire-to-Wire Housing

51115 Female, Panel Mount Type

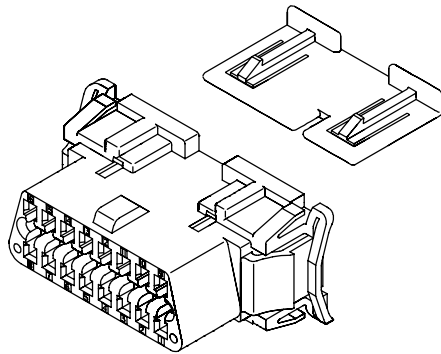

Circuits	Order No.
16	51115-1601
	51115-1611

Features and Benefits

- Size 16 circuits only
- SAE J1962 standard for no board diagnostic
- Panel mount type

Reference Information

Product Specification: PS-51115-001
 Packaging: Bag
 Mates With: 51117 TPA, 68503 (Housing, Cover, CPA),
 68154 (Dummy Plug)
 Use With: 50420
 Designed In: Millimeters

Electrical

Voltage: 30V
 Current: 6.0A max.
 Contact Resistance: 100 milliohms max.
 Dielectric Withstanding Voltage: 1000V AC
 Insulation Resistance: 500V DC 100 Megohms min.

Mechanical

Contact Insertion Force: 9.8N (2.2 lb)
 Contact Retention to Housing: 80.0N min. (with 51117)
 Wire Pull-Out Force:

AVS 0.3	58.8N
AVS 0.5	88.2N
AVS 0.75F	107.8N
AVS 0.85	117.6N

Mating Force: 142N max.
 Unmating Force: 88.0N max.
 Durability: 200 cycles

Physical

Housing: Polyester, UL 94V-0
 TPA: Polyester

www.molex.com/customer.html?seriesNumber=51115

4.00mm (.157") Pitch OBD-II Wire-to-Wire Housing

51116 Female, Screw Mount Type

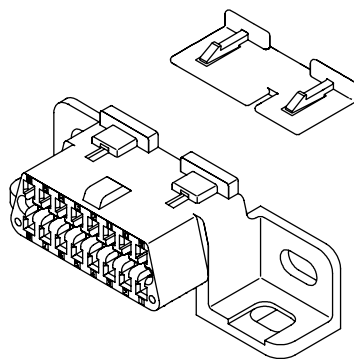

Circuits	Order No.
16	51116-1601
	51116-1611

Features and Benefits

- Size 16 circuits only
- SAE J1962 standard for no board diagnostic
- Screw mount type

Reference Information

Product Specification: PS-51115-001
 Packaging: Bag
 Mates With: 51118 TPA, 68503 (Housing, Cover, CPA),
 68154 (Dummy Plug)
 Use With: 50420
 Designed In: Millimeters

Electrical

Voltage: 30V
 Current: 6.0A max.
 Contact Resistance: 100 milliohms max.
 Dielectric Withstanding Voltage: 1000V AC
 Insulation Resistance: 500V DC 100 Megohms min.

Mechanical

Contact Insertion Force: 9.8N (2.2 lb)
 Contact Retention to Housing: 80.0N min. (with 51117)
 Wire Pull-Out Force:

AVS 0.3	58.8N
AVS 0.5	88.2N
AVS 0.75F	107.8N
AVS 0.85	117.6N

Mating Force: 142N max.
 Unmating Force: 88.0N max.
 Durability: 200 cycles

Physical

Housing: Polyester, UL 94V-0
 TPA: Polyester

1.50mm (.060")
MX150™
Terminals
33001/33012
Female
Mat Sealed

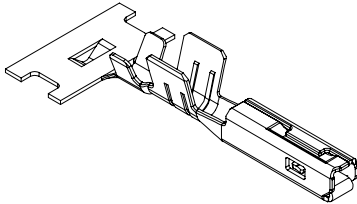

Features and Benefits

- Meets USCAR performance testing
- Low insertion force
- Multiple plating options
- Strong crimps
- Accommodates SAE and metric wires
- Sealed and unsealed versions
- Lead free

Reference Information

Packaging: Reel
Use With: MX150 plastic series 33471, 33472 and 33476
Mates With: 33012 and 33001
Designed In: Millimeters

Electrical

Voltage: 250V
Current: 22.0A
Contact Resistance: 10 milliohms max.
Dielectric Withstanding Voltage: 500V DC
Insulation Resistance: 20 Megohms min.

Mechanical

Contact Insertion Force: 3.0N average
Wire Pull-Out Force: 14 AWG—180N min.
22 AWG—70N
Mating Force: 3.0N average
Unmating Force: 3.0N average
Normal Force: 6.0N average

Physical

Contact: Copper Alloy
Plating: Tin, Gold or Silver
Wire Gauge: 14 to 22 AWG (max. O.D. = 2.49mm)

Order No.		Plating	Wire Gauge
Right Payoff, B Wound	Left Payoff, D Wound		
33012-2001	33012-3001	Tin	14 to 16 AWG
33012-2002	33012-3002		18 to 20 AWG
33012-2003	33012-3003		22 AWG
33001-2003	33001-3003	Gold	14 to 16 AWG
33001-2004	33001-3004		18 to 20 AWG
33001-2005	33001-3005		22 AWG
33001-4001	33001-5001	Silver	14 to 16 AWG
33001-4002	33001-5002		18 to 20 AWG
33001-4003	33001-5003		22 AWG

1.50mm (.060")
MX150™
Terminals
34081/34083
Female
Cable Sealed

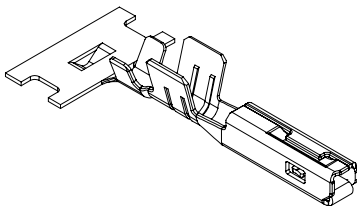

Features and Benefits

- Meets USCAR performance testing
- Low insertion force
- Multiple plating options
- Strong crimps
- Accommodates SAE and metric wires
- Sealed and unsealed versions
- Lead free

Reference Information

Packaging: Reel
Use With: MX150 plastic series 34250 and 34062
Mates With: 34080
Designed In: Millimeters

Electrical

Voltage: 250V
Current: 22.0A
Contact Resistance: 10 milliohms max.
Dielectric Withstanding Voltage: 500V DC
Insulation Resistance: 20 Megohms min.

Mechanical

Contact Insertion Force: 3.0N average
Wire Pull-Out Force: 14 AWG—180N min.
22 AWG—70N
Mating Force: 3.0N average
Unmating Force: 3.0N average
Normal Force: 6.0N average

Physical

Contact: Copper Alloy
Plating: Tin, Gold or Silver
Wire Gauge: 14 to 22 AWG (max. O.D. = 2.49mm)

Order No.		Plating	Wire Gauge
Right Payoff, B Wound	Left Payoff, D Wound		
34083-2001	34083-3001	Tin	14 to 16 AWG
34083-2002	34083-3002		18 to 20 AWG
34083-2003	34083-3003		22 AWG
34081-2003	34081-3003	Gold	14 to 16 AWG
34081-2004	34081-3004		18 to 20 AWG
34081-2005	34081-3005		22 AWG
34081-4001	34081-5001	Silver	14 to 16 AWG
34081-4002	34081-5002		18 to 20 AWG
34081-4003	34081-5003		22 AWG

1.50mm (.060")

**MX150™
Terminals**

33000/33011

**Male
Mat Sealed**

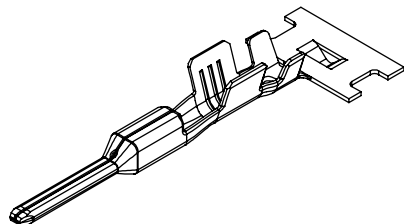

Features and Benefits

- Meets USCAR performance testing
- Low insertion force
- Multiple plating options
- Strong crimps
- Accommodates SAE and metric wires
- Lead free

Reference Information

Packaging: Reel
 Use With: MX150 plastic series 33471, 33472 and 33476
 Mates With: 33012 and 33001
 Designed In: Millimeters

Electrical

Voltage: 250V
 Current: 22.0A
 Contact Resistance: 10 milliohms max.
 Dielectric Withstanding Voltage: 500V DC
 Insulation Resistance: 20 Megohms min.

Mechanical

Contact Insertion Force: 3.0N average
 Wire Pull-Out Force: 14 AWG—180N min.
 22 AWG—70N
 Mating Force: 3.0N average
 Unmating Force: 3.0N average
 Normal Force: 6.0N average

Physical

Contact: Copper Alloy
 Plating: Tin, Gold or Silver
 Wire Gauge: 14 to 22 AWG (max. O.D. = 2.49mm)

Order No.		Plating	Wire Gauge
Right Payoff, B Wound	Left Payoff, D Wound		
33000-0001	33000-1001	Tin	14 AWG
33000-0002	33000-1002		16 to 20 AWG
33000-0003	33000-1003		22 AWG
33011-1002	33011-0002	Gold	14 AWG
33011-1004	33011-0004		16 to 20 AWG
33011-1006	33011-0006		22 AWG
33011-2001	33011-3001	Silver	14 AWG
33011-2002	33011-3002		16 to 20 AWG
33011-2003	33011-3003		22 AWG

1.50mm (.060")

**MX150™
Terminals**

34080

**Male
Cable Sealed**

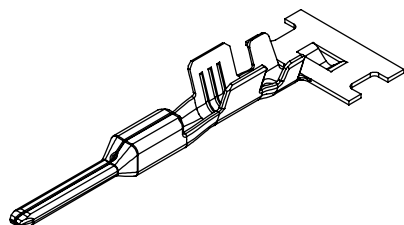

Features and Benefits

- Meets USCAR performance testing
- Low insertion force
- Multiple plating options
- Strong crimps
- Accommodates SAE and metric wires
- Lead free

Reference Information

Packaging: Reel
 Use With: MX150 plastic series 34091 and 34615
 Mates With: 34083
 Designed In: Millimeters

Electrical

Voltage: 250V
 Current: 22.0A
 Contact Resistance: 10 milliohms max.
 Dielectric Withstanding Voltage: 500V DC
 Insulation Resistance: 20 Megohms min.

Mechanical

Contact Insertion Force: 3.0N average
 Wire Pull-Out Force: 14 AWG—180N min.
 22 AWG—70N
 Mating Force: 3.0N average
 Unmating Force: 3.0N average
 Normal Force: 6.0N average

Physical

Contact: Copper Alloy
 Plating: Tin
 Wire Gauge: 14 to 22 AWG (max. O.D. = 2.49mm)

Order No.		Plating	Wire Gauge
Right Payoff, B Wound	Left Payoff, D Wound		
34080-0001	34080-1001	Tin	14 to 16 AWG
34080-0002	34080-1002		18 to 20 AWG
34080-0003	34080-1003		22 AWG

3.50mm (.138") Pitch MX150™ Sealed Connectors

33471 Female
33481 Male
Single Row

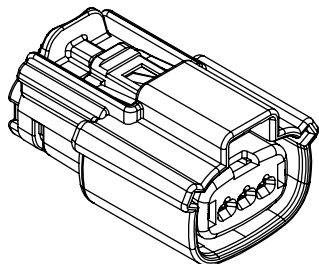

Features and Benefits

- Meets USCAR performance requirements
- Smallest 1.50mm (.059") sealed connector in the market
- Terminal retention is 2x industry standard
- Matte seal design
- Polarization options available
- Available with or without CPA
- Clip slot standard on male side

Reference Information

Packaging: Bulk
Mates With: 33471 and 33481
Use With: MX150 terminals
Designed In: Millimeters

Electrical

Voltage: 250V
Current: 22.0A
Contact Resistance: 20 milliohms max.
Dielectric Withstanding Voltage: 500V DC
Insulation Resistance: 20 Megohms min.

Mechanical

Contact Insertion Force: Less than 15N
Contact Retention to Housing: 110N min.
Wire Pull-Out Force: 90N min.
Mating Force: 75N max.
Unmating Force: 75N max.
Normal Force: Terminal dependent

Physical

Housing: 30% glass filled nylon, UL 94-HB
Contact: Will accommodate Tin, Silver or Gold
Insulation Diameter: 14 AWG UTX 2.49mm O.D. to
22 AWG TXL
Wire Gauge: 14 to 22 AWG and Metric

Circuits	Order No.	Description	Color	CPA Option
2	33471-0201	1x2 Female Polarization A	Black	No
	33471-0202	1x2 Female Polarization B	Gray	
	33471-0206	1x2 Female Polarization A	Black	Yes
	33471-0207	1x2 Female Polarization B	Gray	
	33481-0201	1x3 Male Polarization A	Black	No
	33481-0202	1x3 Male Polarization B	Gray	
3	33471-0301	1x3 Female Polarization A	Black	No
	33471-0302	1x3 Female Polarization B	Gray	
	33471-0306	1x3 Female Polarization A	Black	Yes
	33471-0307	1x3 Female Polarization B	Gray	
	33481-0301	1x3 Male Polarization A	Black	No
	33481-0302	1x3 Male Polarization B	Gray	

Circuits	Order No.	Description	Color	CPA Option
4	33471-0401	1x4 Female Polarization A	Black	No
	33471-0402	1x4 Female Polarization B	Gray	
	33471-0406	1x4 Female Polarization A	Black	Yes
	33471-0407	1x4 Female Polarization B	Gray	
	33481-0401	1x4 Male Polarization A	Black	No
	33481-0402	1x4 Male Polarization B	Gray	
6	33471-0601	1x6 Female Polarization A	Black	No
	33471-0602	1x6 Female Polarization B	Gray	
	33471-0606	1x6 Female Polarization A	Black	Yes
	33471-0607	1x6 Female Polarization B	Gray	
	33481-0601	1x6 Male Polarization A	Black	No
	33481-0602	1x6 Male Polarization B	Gray	

3.50mm (.138") Pitch MX150™ Hybrid Sealed Connectors

33476 Female
33486 Male
Dual Row

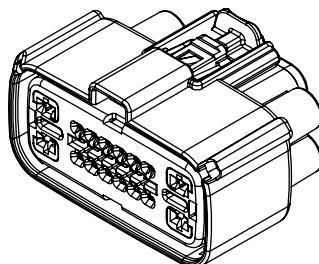

Features and Benefits

- Combines 1.50 and 2.80mm (.059 and .110") terminals in same connector
- Terminal retention is 2x industry standard
- Polarization options available
- Available with or without CPA
- Clip slot standard on male side

Reference Information

Packaging: Bag
Mates with: 33471 and 33481
Use With: MX150 terminals
Designed In: Millimeters

Electrical

Voltage: 250V
Current: 22.0A for 1.5mm terminals and 25.0A for
2.8mm terminals
Contact Resistance: 20 milliohms max.
Dielectric Withstanding Voltage: 500V DC
Insulation Resistance: 20 Megohms min.

Mechanical

Contact Insertion Force: Less than 15N
Contact Retention to Housing: 110N min.
Wire Pull-Out Force: 90N min.
Mating Force: 75N max.
Unmating Force: 75N max.
Normal Force: Terminal dependent

Physical

Housing: 30% glass filled nylon, UL 94-HB
1.5mm terminals
Contact: Tin, Silver or Gold
Insulation Diameter: 14 AWG UTX 2.49mm O.D. to
22 AWG TXL
Wire Gauge: 14 to 22 AWG and Metric
2.8mm terminals
Contacts: Tin
Wire Gauge: 12 to 22 AWG

Order No.	Description	Color	CPA Option
33476-1601	2x8 Female Polarization A	Black	No
33476-1602	2x8 Female Polarization B	Gray	
33476-1606	2x8 Female Polarization A	Black	Yes
33476-1607	2x8 Female Polarization B	Gray	
33486-1601	2x8 Male Polarization A	Black	No
33486-1602	2x8 Male Polarization B	Gray	

3.50mm (.138") Pitch MX150™ Sealed Connectors

33472 Female
33482 Male
Dual Row

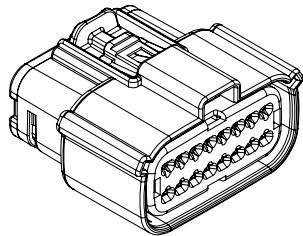

Features and Benefits

- Meets USCAR footprint and performance requirements
- Smallest 1.50mm (.059") sealed connector in the market
- Terminal retention is 2x industry standard
- Matte seal design
- Polarization options available
- Available with or without CPA
- Clip slot standard on male side

Reference Information

Packaging: Bag
Mates With: 33471 and 33481
Use With: MX150 terminals
Designed In: Millimeters

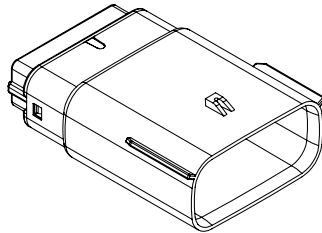

Electrical

Voltage: 250V
Current: 22.0A
Contact Resistance: 20 milliohms max.
Dielectric Withstanding Voltage: 500V DC
Insulation Resistance: 20 Megohms min.

Mechanical

Contact Insertion Force: Less than 15N
Contact Retention to Housing: 110N min.
Wire Pull-Out Force: 90N min.
Mating Force: 75N max.
Unmating Force: 75N max.
Normal Force: Terminal dependent

Physical

Housing: 30% glass filled nylon, UL 94-HB
Contact: Will accommodate Tin, Silver or Gold
Insulation Diameter: 14 AWG UTX 2.49mm O.D. to 22 AWG TXL
Wire Gauge: 14 to 22 AWG and Metric

Circuits	Order No.	Description	Color	CPA Option
4	33472-0401	2x2 Female Polarization A	Black	No
	33472-0402	2x2 Female Polarization B	Gray	
	33472-0406	2x2 Female Polarization A	Black	Yes
	33472-0407	2x2 Female Polarization B	Gray	
	33482-0401	2x2 Male Polarization A	Black	No
	33482-0402	2x2 Male Polarization B	Gray	
6	33472-0601	2x3 Female Polarization A	Black	No
	33472-0602	2x3 Female Polarization B	Gray	
	33472-0606	2x3 Female Polarization A	Black	Yes
	33472-0607	2x3 Female Polarization B	Gray	
	33482-0601	2x3 Male Polarization A	Black	No
	33482-0602	2x3 Male Polarization B	Gray	
8	33472-0801	2x4 Female Polarization A	Black	No
	33472-0802	2x4 Female Polarization B	Gray	
	33472-0806	2x4 Female Polarization A	Black	Yes
	33472-0807	2x4 Female Polarization B	Gray	
	33482-0801	2x4 Male Polarization A	Black	No
	33482-0802	2x4 Male Polarization B	Gray	

Circuits	Order No.	Description	Color	CPA Option
12	33472-1201	2x6 Female Polarization A	Black	No
	33472-1202	2x6 Female Polarization B	Gray	
	33472-1206	2x6 Female Polarization A	Black	Yes
	33472-1207	2x6 Female Polarization B	Gray	
	33482-1201	2x6 Male Polarization A	Black	No
	33482-1202	2x6 Male Polarization B	Gray	
16	33472-1601	2x8 Female Polarization A	Black	No
	33472-1602	2x8 Female Polarization B	Gray	
	33472-1606	2x8 Female Polarization A	Black	Yes
	33472-1607	2x8 Female Polarization B	Gray	
	33482-1601	2x8 Male Polarization A	Black	No
	33482-1602	2x8 Male Polarization B	Gray	
20	33472-2001	2x10 Female Polarization A	Black	No
	33472-2002	2x10 Female Polarization B	Gray	
	33472-2006	2x10 Female Polarization A	Black	Yes
	33472-2007	2x10 Female Polarization B	Gray	
	33482-2001	2x10 Male Polarization A	Black	No
	33482-2002	2x10 Male Polarization B	Gray	

5.00mm (.197") Pitch MX150™ Cable Sealed Connectors

34675
Male
Single Row

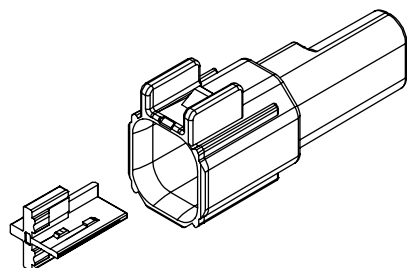

Features and Benefits

- Compact 1.50mm (.059") terminal connector
- Glass-filled thermoplastic housing and pre-loaded terminal position assurance (TPA)
- Optional clip slot
- Audible and tactile clicks on insertion, extraction and mating
- Accommodates up to 14AWG wire

Reference Information

Product Specification: PS-34062-000
Packaging: Bag
Mates With: 34062 female receptacle
Use With: 34080 male terminals
Designed In: Millimeters

Electrical

Voltage: 500V
Current: 22.0A
Contact Resistance: 10 milliohms max.
Dielectric Withstanding Voltage: 1500V AC
Insulation Resistance: 20 Megohms min.

Mechanical

Contact Insertion Force: 30N (6.7 lb) max.
Contact Retention to Housing: 90N (20.2 lb) min.
Mating Force: 45N (10.1 lb)
Unmating Force: 45N (10.1 lb)
Durability: 10 cycles

Physical

Housing: Nylon 6, 30% glass filled

Circuits	Order No.	Clip Slot	Lead-free
2	34675-0001	No	Yes
	34675-0002		
	34675-0003	Yes	
	34675-0004		

4.50mm (.177") Pitch MX150™ Cable Sealed Connector

34250
Single Row

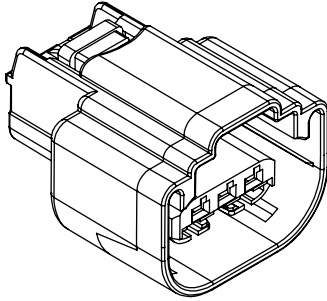

Features and Benefits

- Compact 1.50mm (.059") terminal connector
- Meets USCAR footprints
- Uses cable sealed terminals
- Available with or without CPA
- Polarization options available
- Single and dual key options

Reference Information

Packaging: Bag
Mates With: Direct connect only
Designed In: Millimeters

Electrical

Voltage: 250V
Current: 15.0A
Contact Resistance: 20 milliohms max.
Dielectric Withstanding Voltage: 500V DC
Insulation Resistance: 20 Megohms min.

Mechanical

Contact Insertion Force: Less than 15N
Contact Retention to Housing: 100N min.
Wire Pull-Out Force: 90N min.
Mating Force: Less than 45N
Unmating Force: Less than 45N
Normal Force: Terminal dependent

Physical

Housing: PBT + 10% glass filled, UL 94-HB
Contact: Tin or Gold
Wire Gauge: 16 to 22 AWG

Order No.	Description	Color	CPA
34250-0001	1x3 Dual Key Polarization A	Black	Yes
34250-0002	1x3 Dual Key Polarization B	Gray	
34250-0003	1x3 Dual Key Polarization C	Brown	
34250-0004	1x3 Dual Key Polarization D	Green	No
34250-0017	1x3 Dual Key Polarization A	Black	
34250-0018	1x3 Dual Key Polarization B	Gray	
34250-0019	1x3 Dual Key Polarization C	Brown	Yes
34250-0020	1x3 Dual Key Polarization D	Green	
34250-0033	1x3 Single Key Polarization A	Black	
34250-0034	1x3 Single Key Polarization B	Gray	No
34250-0035	1x3 Single Key Polarization C	Brown	
34250-0036	1x3 Single Key Polarization D	Green	
34250-0049	1x3 Single Key Polarization A	Black	No
34250-0050	1x3 Single Key Polarization B	Gray	
34250-0051	1x3 Single Key Polarization C	Brown	
34250-0052	1x3 Single Key Polarization D	Green	

5.00mm (.197") Pitch MX150™ Cable Sealed Connector

34062
Single Row

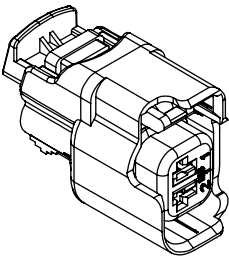

Features and Benefits

- Compact 1.50mm (.059") terminal connector
- Meets USCAR footprints
- Uses cable sealed terminals
- Available with or without CPA
- Polarization options available

Reference Information

Packaging: Bag
Mates With: Direct connect only
Designed In: Millimeters

Electrical

Voltage: 250V
Current: 15.0A
Contact Resistance: 20 milliohms max.
Dielectric Withstanding Voltage: 500V DC
Insulation Resistance: 20 Megohms min.

Mechanical

Contact Insertion Force: Less than 15N
Contact Retention to Housing: 100N min.
Wire Pull-Out Force: 90N min.
Mating Force: Less than 45N
Unmating Force: Less than 45N
Normal Force: Terminal dependent

Physical

Housing: PBT + 10% glass filled, UL 94-HB
Contact: Tin or Gold
Wire Gauge: 16 to 22AWG

Order No.	Description	Color	CPA
34062-0001	1x2 Polarization A	Black	No
34062-0002	1x2 Polarization B	Gray	
34062-0003	1x2 Polarization C	Black	
34062-0004	1x2 Polarization D		
34062-0005	1x2 Polarization A	Black	Yes
34062-0006	1x2 Polarization B	Gray	
34062-0007	1x2 Polarization C	Black	
34062-0008	1x2 Polarization D		
34062-0009	1x2 Polarization D	Gray	No
34062-0010	1x2 Polarization D	Gray	Yes

2.50mm (.098") Pitch Splash Proof Wire-to-Wire Crimp Terminal

50148

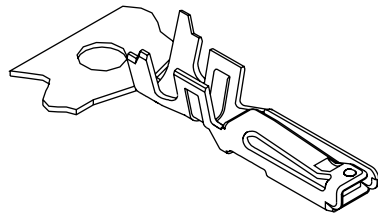

Order No.	Packaging	Lead-free
50148-8000	Reel	Yes
50148-8100	Bag	

Features and Benefits

- Unique spring-beam design provides high pressure and small deflection for high vibration applications
- Stabilizing bump at tip keeps terminal in place during mating

Reference Information

Packaging: Reel or bag
Use With: 52213
Designed In: Millimeters

Electrical

Voltage: 18V max. (2 circuits)
25V max. (3-4 circuits)
Current: AVSS/CAVS 0.50 sq. (20 AWG)—4.0A
AVSS/CAVS 0.30 sq. (22 AWG)—3.0A

Physical

Contact: Phosphor Bronze
Plating: Tin
Wire Range: AVSS/CAVS 0.30 sq., 0.50 sq. (20 to 22 AWG)
Insulation Range: 1.40 to 1.70mm
Strip Length: 2.00 to 2.50mm

2.50mm (.098") Pitch Splash Proof Wire-to-Wire Crimp Terminal

50147

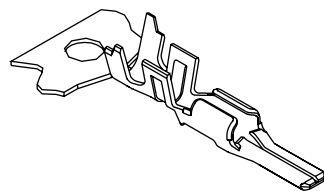

Order No.	Packaging	Lead-free
50147-8000	Reel	Yes
50147-8100	Bag	

Features and Benefits

- Seal is in housing to simplify crimping process
- Raised split-beam design provides polarization

Reference Information

Packaging: Reel or bag
Use With: 52266
Designed In: Millimeters

Electrical

Voltage: 18V max. (2 circuits)
25V max. (3-4 circuits)
Current: AVSS/CAVS 0.50 sq. (20 AWG)—4.0A
AVSS/CAVS 0.30 sq. (22 AWG)—3.0A

Physical

Contact: Phosphor Bronze
Plating: Tin
Wire Range: AVSS/CAVS 0.30 sq., 0.50 sq. (20 to 22 AWG)
Insulation Range: 1.40 to 1.70mm
Strip Length: 2.00 to 2.50mm

2.50mm (.098") Pitch Splash Proof Wire-to-Wire Receptacle

52213
2-Circuit Version

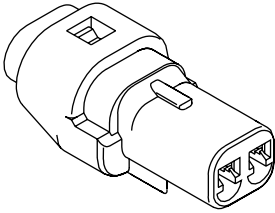

Circuits	Order No.
2	52213-0211

Features and Benefits

- Size 2 circuits
- JIS D0203 S2 waterproof compliant
- Unique seal stopper design provides low insertion force
- For tight packaging applications
- User-friendly friction lock saves space and protects locking latch area
- Polarizing rib to ensure proper mating

Reference Information

Product Specification: PS-52213-001
 Packaging: Tray
 Mates With: 52266
 Use With: 50148
 Designed In: Millimeters

Electrical

Voltage: 18V max.
 Current: 4.0A max.
 Contact Resistance: 10 milliohms max.
 Dielectric Withstanding Voltage: 500V AC/1 min.
 Insulation Resistance: 250 Megohms min.

Physical

Housing: Black glass-filled PBT
 Cap: Glass-filled PBT
 Wire End Seal: Silicone

2.50mm (.098") Pitch Splash Proof Wire-to-Wire Receptacle

52213
3 and 4-Circuit Version

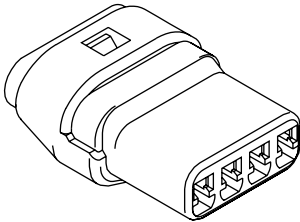

Circuits	Order No.	Housing/Cap Color
3	52213-0311	Black
4	52213-0417	Brown

Features and Benefits

- Sizes 3 and 4 circuits
- JIS D0203 S2 waterproof compliant
- Unique seal stopper design provides low insertion force
- For tight packaging applications
- User-friendly friction lock saves space and protects locking latch area
- One-body wire and seal enables tighter spacing between terminals

Reference Information

Product Specification: PS-52213-002
 Packaging: Tray
 Mates With: 52266
 Use With: 50148
 Designed In: Millimeters

Electrical

Voltage: 25V max.
 Current: 4.0A max.
 Contact Resistance: 10 milliohms max.
 Dielectric Withstanding Voltage: 500V AC/1 min.
 Insulation Resistance: 250 Megohms min.

Physical

Housing/Cap: Glass-filled PBT
 Wire End Seal: Silicone

2.50mm (.098") Pitch Splash Proof Wire-to-Wire Plug

52266
2-Circuit Version

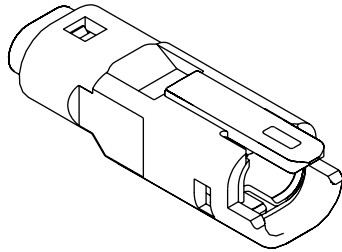

Circuits	Order No.
2	52266-0211

Features and Benefits

- Size 2 circuits
- JIS D0203 S2 waterproof compliant
- Unique seal stopper design provides low insertion force
- For tight packaging applications
- User-friendly friction lock saves space and protects locking latch area
- One-body wire and seal enables tighter spacing between terminals

Reference Information

Product Specification: PS-52213-001
Packaging: Tray
Mates With: 52213
Use With: 50147
Designed In: Millimeters

Electrical

Voltage: 18V max.
Current: 4.0A max.
Contact Resistance: 10 milliohms max.
Dielectric Withstanding Voltage: 500V AC/1 min.
Insulation Resistance: 250 Megohms min.

Physical

Housing: Black glass-filled PBT
Cap: Glass-filled PBT
Wire End Seal: Silicone
Seal Stopper: Glass-filled PBT
Seal: Silicone

2.50mm (.098") Pitch Splash Proof Wire-to-Wire Plug

52266
3 and 4-Circuit Version

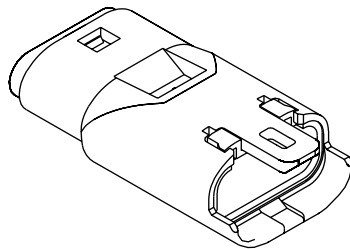

Circuits	Order No.	Housing/ Cap Color
3	52266-0311	Black
4	52266-0417	Brown

Features and Benefits

- Sizes 3 and 4 circuits
- JIS D0203 S2 waterproof compliant
- Unique seal stopper design provides low insertion force
- For tight packaging applications
- User-friendly friction lock saves space and protects locking latch area
- One-body wire and seal enables tighter spacing between terminals

Reference Information

Product Specification: PS-52213-002
Packaging: Tray
Mates With: 52213
Use With: 50147
Designed In: Millimeters

Electrical

Voltage: 25V max.
Current: 4.0A max.
Contact Resistance: 10 milliohms max.
Dielectric Withstanding Voltage: 500V AC/1 min.
Insulation Resistance: 250 Megohms min.

Physical

Housing/Cap: Glass-filled PBT
Wire End Seal: Silicone
Seal Stopper: Glass-filled PBT
Seal: Silicone

2.50mm (.098") Pitch Splash Proof Wire-to-Wire Crimp Terminal

50039

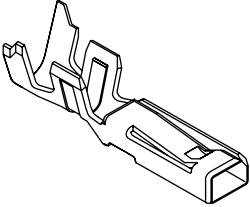

Features and Benefits

- Unique spring-beam design provides high pressure and small deflection for high vibration applications

Reference Information

Packaging: Reel or Bag
Use With: 52117
Designed In: Millimeters

Electrical

Voltage: 250V
Current: 3.0A

Physical

Contact: Phosphor Bronze
Plating: Tin
Wire Range: AVS 0.30 sq., CAVS 0.50 sq. (20 to 22 AWG)
Insulation Range: 1.80 to 1.90mm
Strip Length: 2.00 to 2.50mm

Order No.	Packaging	Lead-free
50039-8000	Reel	Yes
50039-8100	Bag	

2.50mm (.098") Pitch Splash Proof Wire-to-Wire Crimp Terminal

50038

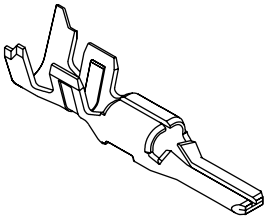

Features and Benefits

- Seal is in housing to simplify crimping process
- Raised body design provides polarization

Reference Information

Packaging: Reel or Bag
Use With: 52116
Designed In: Millimeters

Electrical

Voltage: 250V max.
Current: 3.0A max.

Physical

Contact: Phosphor Bronze
Plating: Tin
Wire Range: AVS 0.30 sq., CAVS 0.50 sq. (20 to 22 AWG)
Insulation Range: 1.80 to 1.90mm
Strip Length: 2.00 to 2.50mm

Order No.	Packaging	Lead-free
50038-8000	Reel	Yes
50038-8100	Bag	

2.50mm (.098") Pitch Splash Proof Wire-to-Wire Receptacle Housing

52117

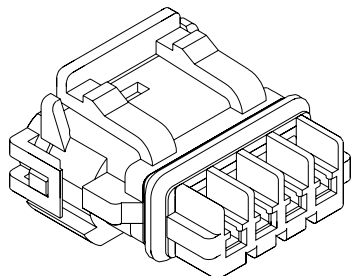

Circuits	Order No.
2	52117-024X
3	52117-034X
4	52117-041X

Note: Replace X with
 0 = White color
 1 = Black color
 2 = Red color (available in 2 and 3 circuits only)

Features and Benefits

- Sizes 2 to 4 circuits
- JIS D0203 S2 compliant
- User friendly friction lock provides secure connection

Reference Information

Product Specification: PS-52117-001 (2 circuits)
 PS-52117-003 (3 circuits)
 PS-52117-005 (4 circuits)

Packaging: Tray
 Mates With: 52116 housing
 Use With: 50039 terminal
 Designed In: Millimeters

Electrical

Voltage: 250V max.
 Current: 3.0A max.
 Contact Resistance: 10 milliohms max.
 Dielectric Withstanding Voltage: 500V AC/1 min.
 Insulation Resistance: 250 Megohms min.

Physical

Housing: Glass-filled PBT
 Cap: Glass-filled PBT
 Seal: Silicon

2.50mm (.098") Pitch Splash Proof Wire-to-Wire Plug Housing

52116

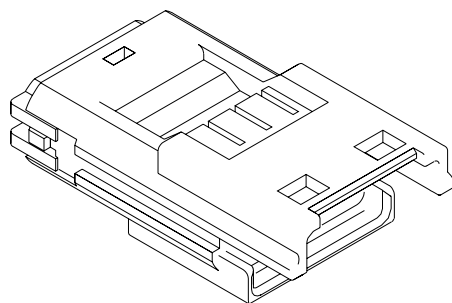

Circuits	Order No.
2	52116-024X
3	52116-034X
4	52116-041X

Note: Replace X with
 0 = White color
 1 = Black color
 2 = Red color (available in 2 and 3 circuits only)

Features and Benefits

- Sizes 2 to 4 circuits
- JIS D0203 S2 compliant
- User friendly friction lock provides secure connection

Reference Information

Product Specification: PS-52117-001 (2 circuits)
 PS-52117-003 (3 circuits)
 PS-52117-005 (4 circuits)

Packaging: Tray
 Mates With: 52117 housing
 Use With: 50038 terminal
 Designed In: Millimeters

Electrical

Voltage: 250V max.
 Current: 3.0A max.
 Contact Resistance: 10 milliohms max.
 Dielectric Withstanding Voltage: 500V AC/1 min.
 Insulation Resistance: 250 Megohms min.

Physical

Housing: Glass-filled PBT
 Cap: Glass-filled PBT
 Seal: Silicon

4.20mm (.165") Pitch Mini-Fit® Family Terminal

5556 Crimp, Female

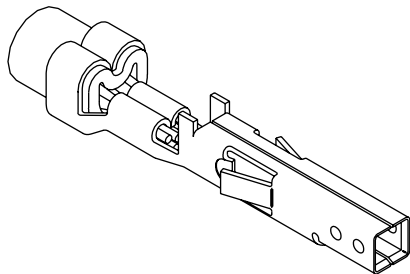

Features and Benefits

- Four gas-tight points of contact

Reference Information

Product Specification: PS-5556-001

Application Specifications: ATS-639002600
ATS-639002800

UL File No: E29179

CSA File No: LR19980

TUV License No: R75142

Use With: 5557, 30067, 42474 and 44516 receptacles

Electrical

Current: 9.0 max. (See applicable product specification.)

Voltage: 600V

Contact Resistance: 10 milliohms max.

Mechanical

Mating Force: 14.7N max. per contact

Unmating Force: 1.0N min. per contact

Normal Force: 0.49N min. per contact

Mating Cycles: 30 cycles

Physical

Contact Material: Brass or Phosphor Bronze

Wire Size: 16-24 AWG (See Product and Application Tooling specifications for complete crimping guidelines.)

Contact Material	Wire Size (AWG)	Plating	Order No. 5556		Lead-free
			Reel	Bag	
Brass	16	Tin	39-00-0077	39-00-0078	Yes
	18-24		39-00-0038	39-00-0039	
Phosphor Bronze	16		39-00-0079	39-00-0080	
	18-24		39-00-0059	39-00-0060	

4.20mm (.165") Pitch Mini-Fit® Family Terminal

5558 Crimp, Male

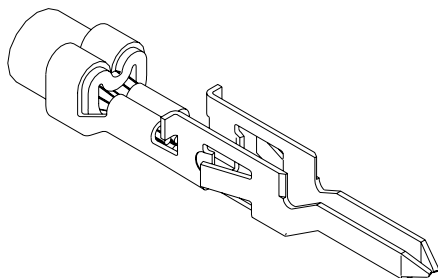

Features and Benefits

- Crimp terminal for use in all Mini-Fit, Jr., BMI and TPA plug housings

Reference Information

Product Specification: PS-5556-001

Application Specifications: ATS-639002600
ATS-639002800

UL File No: E29179

CSA File No: LR19980

TUV License No: R75142

Use With: 5559, 42475 and 30068 plug housings

Electrical

Voltage: 600V

Current: 9.0A max.

Contact Resistance: 10 milliohms max.

Mechanical

Mating Force: 14.7N max. per contact

Unmating Force: 1.0N max. per contact

Normal Force: 0.49N min. per contact

Mating Cycles: 30 cycles

Physical

Contact Material: Brass or Phosphor Bronze (See applicable product specification.)

Wire Size: 16-24 AWG (See Product and Application Tooling specifications for complete crimping guidelines.)

Contact Material	Wire Size (AWG)	Plating	Order No.		Lead-free
			Reel	Bag	
Brass	16	Tin	39-00-0081	39-00-0082	Yes
	18-24		39-00-0040	39-00-0041	
Phosphor Bronze	16		39-00-0083	39-00-0084	
	18-24		39-00-0061	39-00-0062	

4.20mm (.165") Pitch Mini-Fit Jr.™ Crimp Terminal Receptacle

5557
Single Row

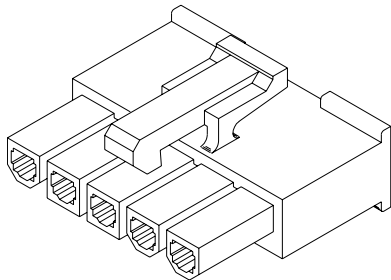

Circuits	Order No.	
	94V-2	94V-0
3*	39-01-4030	39-01-4031
4	39-01-4040	39-01-4041
5	39-01-4050	39-01-4051

*3-circuit receptacle designed for first-mate/last-break applications

Features and Benefits

- Low profile design to accommodate height constraints
- Fully isolated terminals to protect contacts from damage
- For wire-to-wire or wire-to-board applications

Reference Information

Product Specification: PS-5556-001
 UL File No: E29179
 CSA File No: LR19980
 TUV License No: R75142
 Mates With: 5559, 5566 and 5569 single row connectors
 Use With: 5556, 46083 or 45750 terminals

Electrical

See Crimp Terminal page.

Mechanical

Locking: Positive

Physical

Housing: 6/6 nylon, UL 94V-2 or 94V-0

4.20mm (.165") Pitch Mini-Fit Jr.™ Crimp Terminal Housing Plug

5559
Single Row, with and
Without Panel Mount Ears

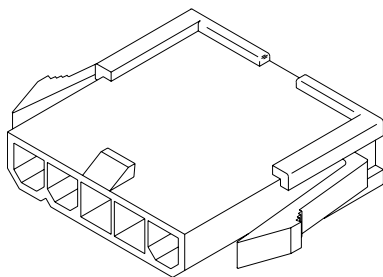

Features and Benefits

- Wire-to-wire plug for panel-mounted or free-hanging applications
- Available with and without panel mounting ears
- Positive housing locks to mate with Mini-Fit Jr. receptacle
- Fully isolated terminals to protect contacts from damage

Reference Information

Product Specification: PS-5556-001
 UL File No.: E29179
 CSA File No.: LR19980
 TUV License No.: R75142
 Mates With: 5557 single row receptacles
 Use With: 5558, 30490, 46134 or 46012 terminals
 Panel Thickness: .079 to 2.00mm (.031 to 0.80")

Electrical

See Crimp Terminal page.

Mechanical

Locking: Positive

Physical

Housing: 6/6 nylon, UL 94V-2 or 94V-0

Circuits	Order No.			
	Panel Mount		Free Hanging	
	94V-2	94V-0	94V-2	94V-0
3*	39-01-4032	39-01-4033	39-01-4036	39-01-4037
4			39-01-4046	39-01-4047
5	39-01-4052	39-01-4053	39-01-4056	39-01-4057

*3-circuit plug designed for first-mate/last-break applications

4.20mm (.165") Pitch Mini-Fit Jr.™ Header

5566
Vertical, Single Row
With Pegs

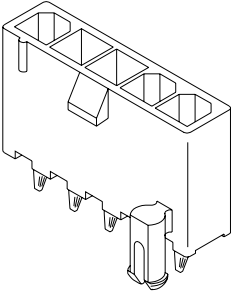

Features and Benefits

- Positive housing locks to mate with Mini-Fit Jr. single row receptacle
- Fully isolated terminals to protect contacts from damage
- Peg-mounted vertical headers for increased board retention
- Drain holes are standard to allow washing of PCB after processing (contact Molex for headers without drain holes)

Reference Information

Product Specification: PS-5556-001
 UL File No: E29179
 CSA File No: LR19980
 TUV License No: R75142
 Mates With: 5557 Single row receptacles
 Use With: 5556 and 46083 terminals

Electrical

Current: 9.0A max. (See applicable product specification.)
 Voltage: 600V
 Contact Resistance: 10 milliohms max.

Mechanical

Mating Cycles: 30 cycles

Physical

Housing: 6/6 nylon, UL 94V-2 or 94V-0
 Contact Material: Brass

Circuits	Order No.				Tail Length	Lead-free
	Tin Plated		Select Gold Plated (30µ")			
	94V-2	94V-0	94V-2	94V-0		
3	39-30-5039	39-30-6030	39-30-2037	39-30-2038	3.5mm (0.14")	Yes
4	39-30-5049	50-30-4466	39-30-2047	39-30-2048		
5		50-30-4467		39-30-2058		

4.20mm (.165") Pitch Mini-Fit Jr.™ Header

5569
Right Angle, Single Row
With Flanges

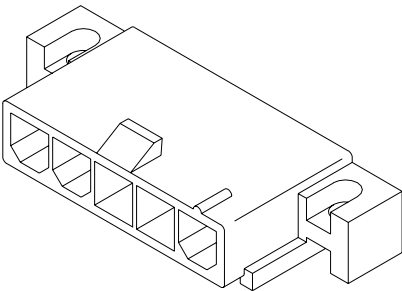

Features and Benefits

- Flanges allow for screw-in retention to board-mounted headers
- Low profile is ideal for power applications with space constraints

Reference Information

Product Specification: PS-5556-001
 UL File No.: E29179
 CSA File No.: LR19980
 TUV License No.: R75142
 Mates With: 5557 single row receptacle
 Use With: 5556, 46083 and 45750 terminals

Electrical

Current: 12.0A max. (See applicable product specification.)
 Voltage: 600V
 Contact Resistance: 10 milliohms max.

Mechanical

Mating cycles: 30 cycles

Physical

Housing: 6/6 nylon, UL 94V-2 or 94V-0
 Contact Material: Brass

Circuits	Order No.				Tail Length	Lead-free
	Tin Plated		Select Gold Plated			
	94V-2	94V-0	94V-2	94V-0		
3	39-30-6039	39-30-7030	39-30-4037	39-30-4038	3.6mm	Yes
4	39-30-6049		50-30-4443			

4.20mm (.165") Pitch Mini-Fit Jr.™ Header

5569 Right Angle, Single Row With Pegs

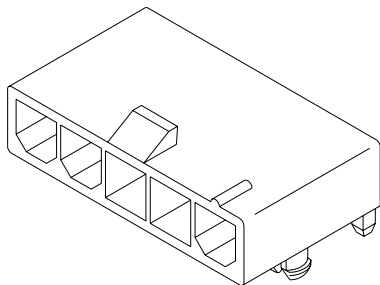

Features and Benefits

- Pegs provide increased board retention
- Ideal for low profile power applications
- Positive housing locks to mate with Mini-Fit Jr. single row receptacles
- Fully isolated terminals to protect contacts from damage

Reference Information

Product Specification: PS-5556-001
 UL File No.: E29179
 CSA File No.: LR19980
 TUV License No.: R75142
 Mates With: 5557 single row receptacles
 Use With: 5556, 46083 and 45750 terminals

Electrical

Current: 12.0A max. (See applicable product specification.)
 Voltage: 600V
 Contact Resistance: 10 milliohms max.

Mechanical

Mating cycles: 30 cycles

Physical

Housing: 6/6 nylon, UL 94V-2 or 94V-0
 Contact Material: Brass

Circuits	Order No.				Tail Length	Lead-free
	Tin Plated		Select Gold Plated			
	94V-2	94V-0	94V-2	94V-0		
3	39-30-7031	39-30-7032	39-30-4031	39-30-4032	3.6mm	Yes
4	39-30-7041	39-30-7042	50-30-4438	50-30-4441		
5	39-30-7051	39-30-7052	50-30-4439	50-30-4442		

4.20mm (.165") Pitch Mini-Fit Jr.™ Crimp Terminal Housing Receptacle

5557 Dual Row

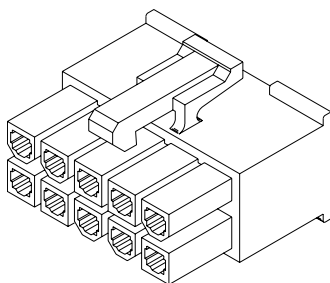

Features and Benefits

- Positive housing lock for secure mating retention
- Fully isolated terminals to protect contacts from damage
- Thumbblatch for easy unmating

Reference Information

Product Specification: PS-5556-001
 UL File No.: E29179
 CSA File No.: LR19980
 TUV License No.: R75142
 Mates With: 5559, 5566, 5569, 42404, 42440, 42475, 43810, 43879 and 44068 dual row connectors
 Use With: 5556, 46083 or 45750 terminals

Electrical

See Crimp Terminal page.

Mechanical

Locking: Positive

Physical

Housing: 6/6 nylon, UL 94V-2 or 94V-0

Circuits	Order No.		Circuits	Order No.	
	94V-2	94V-0		94V-2	94V-0
2	39-01-2020	39-01-2025	14	39-01-2140	39-01-2145
4	39-01-2040	39-01-2045	16	39-01-2160	39-01-2165
6	39-01-2060	39-01-2065	18	39-01-2180	39-01-2185
8	39-01-2080	39-01-2085	20	39-01-2200	39-01-2205
10	39-01-2100	39-01-2105	22	39-01-2220	39-01-2225
12	39-01-2120	39-01-2125	24	39-01-2240	39-01-2245

4.20mm (.165") Pitch Mini-Fit Jr.™ Crimp Terminal Housing Plug

5559
Dual Row
With and without Panel Mount Ears

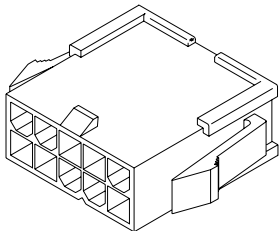

Features and Benefits

- Wire-to-wire plug for panel-mounted or free-hanging applications
- Positive housing locks to mate with Mini-Fit Jr. receptacle
- Fully isolated terminals to protect contacts from damage

Reference Information

Product Specification: PS-5556-001
UL File No.: E29179
CSA File No.: LR19980
TUV License No.: R75142
Mates With: 5557 dual row receptacle
Use With: 5558, 30490, 46134 or 46012 terminals
Panel Thickness: .079 to 2.00mm (.031 to 0.80")

Electrical

See Crimp Terminal page.

Mechanical

Locking: Positive

Physical

Housing: 6/6 nylon, UL 94V-2 or 94V-0

Circuits	Order No.			
	Panel Mount		Free Hanging	
	94V-2	94V-0	94V-2	94V-0
2	39-01-2021	39-01-2026	39-01-3023	39-01-3029
4	39-01-2041	39-01-2046	39-01-3043	39-01-3049
6	39-01-2061	39-01-2066	39-01-3063	39-01-3069
8	39-01-2081	39-01-2086	39-01-3083	39-01-3089
10	39-01-2101	39-01-2106	39-01-3103	39-01-3109
12	39-01-2121	39-01-2126	39-01-3123	39-01-3129
14	39-01-2141	39-01-2146	39-01-3143	39-01-3149
16	39-01-2161	39-01-2166	39-01-3163	39-01-3169
18	39-01-2181		39-01-3183	
20	39-01-2201			
22	39-01-2221			
24	39-01-2241	39-01-2246		

4.20mm (.165") Pitch Mini-Fit Jr.™ Header

5566
Vertical, Dual Row
With Pegs, with Drain Holes

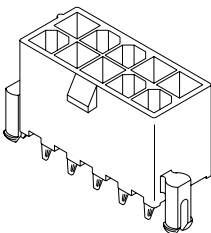

Features and Benefits

- Board-mounting pegs provide polarization during placement on the PCB and increased retention during soldering process
- Positive housing locks to mate with Mini-Fit Jr. receptacle
- Fully isolated terminals to protect contacts from damage
- Drain holes are standard to allow washing of PCB after processing (contact Molex for headers without drain holes)

Reference Information

Product Specification: PS-5556-001
UL File No.: E29179
CSA File No.: LR19980
TUV License No.: R75142
Mates With: 5557 dual row receptacle
Use With: 5556 and 46083 terminals

Electrical

Current: 19.0A max. (See applicable product specification.)
Voltage: 600V
Contact Resistance: 10 milliohms max.

Mechanical

Mating Cycles: 30 cycles

Physical

Housing: 6/6 nylon, UL 94V-2 or 94V-0
Contact Material: Brass

Circuits	Order No.				Tail Length	Lead-free
	Tin Plated		Gold Plated (30µt")			
	94V-2	94V-0	94V-2	94V-0		
2	39-30-6027	39-30-6028	39-29-9024	39-28-9028	3.5mm	Yes
4	39-30-6047	39-30-6048	39-29-9044	39-28-9048		
6	39-30-6067	39-30-6068	39-29-9064	39-28-9068		
8	39-30-6087	39-30-6088	39-29-9084	39-28-9088		
10	39-30-6107	39-30-6108	39-29-9104	39-28-9108		
12	39-30-6127	39-30-6128	39-29-9124	39-28-9128		
14	39-30-6147	39-30-6148	39-29-9144	39-28-9148		
16	39-30-6167	39-30-6168	39-29-9164	39-28-9168		
18	39-30-6187	39-30-6188	39-29-9184	39-28-9188		
20	39-30-6207	39-30-6208	39-29-9204	39-28-9208		
22	39-30-6227	39-30-6228	39-29-9224			
24	39-30-6247	39-30-6248	39-29-9244	39-28-9248		

4.20mm (.165") Pitch

Mini-Fit Jr.™

Header

5566

Vertical, Dual Row

Without Pegs, without Drain Holes

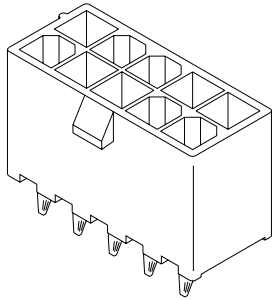

Features and Benefits

- Positive housing locks to mate with Mini-Fit Jr. receptacle
- Fully isolated terminals to protect contacts from damage
- Drain hole option available, contact Molex

Reference Information

Product Specification: PS-5556-001
 UL File No.: E29179
 CSA File No.: LR19980
 TUV License No.: R75142
 Mates With: 5557 dual row receptacle
 Use With: 5556 and 46083 terminals

Electrical

Current: 19.0A max. (See applicable product specification.)
 Voltage: 600V
 Contact Resistance: 10 milliohms max.

Mechanical

Mating Cycles: 30 cycles

Physical

Housing: 6/6 nylon, UL 94V-2 or 94V-0
 Contact Material: Brass

Circuits	Order No.		Plating	Tail Length	Lead-free
	94V-2	94V-0			
2	39-28-1023	39-28-8020	Tin	3.5mm	Yes
4	39-28-1043	39-28-8040			
6	39-28-1063	39-28-8060			
8	39-28-1083	39-28-8080			
10	39-28-1103	39-28-8100			
12	39-28-1123	39-28-8120			

Circuits	Order No.		Plating	Tail Length	Lead-free
	94V-2	94V-0			
14	39-28-1143	39-28-8140	Tin	3.5mm	Yes
16	39-28-1163	39-28-8160			
18	39-28-1183	39-28-8180			
20	39-28-1203	39-28-8200			
22	39-28-1223	39-28-8220			
24	39-28-1243	39-28-8240			

4.20mm (.165") Pitch

Mini-Fit Jr.™

Header

5569

Right Angle, Dual Row with Pegs

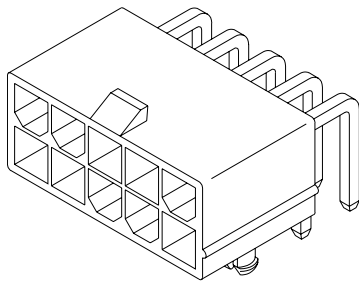

Features and Benefits

- Board mounting pegs provide polarization during placement on PCB and increased board retention during solder processing
- Low profile for space constraints
- Positive housing locks
- Fully isolated terminals to protect contacts from damage

Reference Information

Product Specification: PS-5556-001
 UL File No.: E29179
 CSA File No.: LR19980
 TUV License No.: R75142
 Mates With: 5557 dual row receptacles
 Use With: 5556, 46083 and 45750 terminals

Electrical

Current: 12.0A max. (See applicable product specification.)
 Voltage: 600V
 Contact Resistance: 10 milliohms max.

Mechanical

Mating Cycles: 30 cycles

Physical

Housing: 6/6 nylon, UL 94V-2 or 94V-0
 Contact Material: Brass

Circuits	Order No.				Tail Length	Lead-free
	Tin Plated		Select Gold Plated (30µ")			
	94V-2	94V-0	94V-2	94V-0		
2	39-30-7025	39-30-7026	39-30-0023	39-30-0024	3.6mm	Yes
4	39-30-7045	39-30-7046	39-30-0043	39-30-0044		
6	39-30-7065	39-30-7066	39-30-0063	39-30-0064		
8	39-30-7085	39-30-7086	39-30-0083	39-30-0084		
10	39-30-7105	39-30-7106	39-30-0103	39-30-0104		
12	39-30-7125	39-30-7126	39-30-0123	39-30-0124		
14	39-30-7145	39-30-7146	39-30-0143	39-30-0144		
16	39-30-7165	39-30-7166	39-30-0163	39-30-0164		
18	39-30-7185		39-30-0183			
20	39-30-7205	39-30-7206	39-30-0203	39-30-0204		
22	39-30-7225					
24	39-30-7245	39-30-7246	39-30-0243	39-30-0244		

4.20mm (.165") Pitch Mini-Fit Jr.™ Header

5569
Right Angle, Dual Row
With Flanges

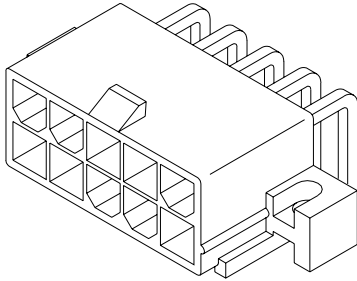

Features and Benefits

- Flanges allow for screw-in retention to board-mounted header
- Low profile for space constraints
- Positive housing locks

Reference Information

Product Specification: PS-5556-001
UL File No.: E29179
CSA File No.: LR19980
TUV License No.: R75142
Mates With: 5557 dual row receptacles
Use With: 5556, 46083 and 45750 terminals

Electrical

Current: 12.0A max. (See applicable product specification.)
Voltage: 600V
Contact Resistance: 10 milliohms max.

Mechanical

Mating Cycles: 30 cycles

Physical

Housing: 6/6 nylon, UL 94V-2 or 94V-0
Contact Material: Brass

Circuits	Order No.		Plating	Tail Length	Lead-free
	94V-2	94V-0			
2	39-29-1028	39-29-1027	Tin	3.5mm	Yes
4	39-29-1048	39-29-1047			
6	39-29-1068	39-29-1067			
8	39-29-1088	39-29-1087			
10	39-29-1108	39-29-1107			
12	39-29-1128	39-29-1127			

Circuits	Order No.		Plating	Tail Length	Lead-free
	94V-2	94V-0			
14	39-29-1148	39-29-1147	Tin	3.5mm	Yes
16	39-29-1168	39-29-1167			
18	39-29-1188	39-29-1187			
20	39-29-1208	39-29-1207			
22	39-29-1228	39-29-1227			
24	39-29-1248	39-29-1247			

4.20mm (.165") Pitch Mini-Fit Jr.™ Wire-to-Board Header

87427
Vertical without Flanges
High Temperature Material

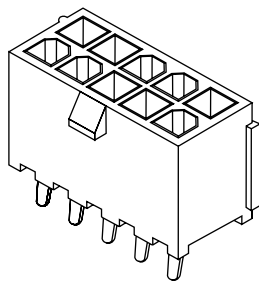

Features and Benefits

- Molded in high temperature, surface mount compatible material
- Fully isolated terminals to protect contacts from damage

Reference Information

Product Specification: PS-87427-0001
UL File No.: E29179
CSA File No.: LR19980
Mates With: 5557 dual row receptacles
Use With: 5556, 46083 and 45750 terminals

Electrical

Current: 12.0A max. (See applicable product specification.)
Voltage: 600V
Contact Resistance: 10 milliohms max.

Mechanical

Mating Cycles: 30 cycles

Physical

Housing: 4/6 Nylon, UL 94V-0
Contact Material: Brass

Circuits	Order No.		Tail Length	Lead-free
	Tin Over Nickel Plating	Tin Over Copper Plating		
2	87427-0242	87427-0243	3.3mm	Yes
4	87427-0442	87427-0443		
6	87427-0642	87427-0643		
8	87427-0842	87427-0843		
10	87427-1042	87427-1043		
12	87427-1242	87427-1243		

Circuits	Order No.		Tail Length	Lead-free
	Tin Over Nickel Plating	Tin Over Copper Plating		
14	87427-1442	87427-1443	3.3mm	Yes
16	87427-1642	87427-1643		
18	87427-1842	87427-1843		
20	87427-2042	87427-2043		
22	87427-2242	87427-2243		
24	87427-2442	87427-2443		

4.20mm (.165") Pitch Mini-Fit Jr.™ Wire-to-Board Header

87427
Right Angle without Flanges
High Temperature Material

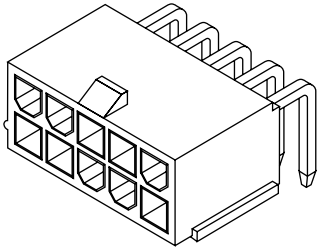

Features and Benefits

- Molded in high temperature, surface mount compatible material
- Fully isolated terminals to protect contacts from damage

Reference Information

Product Specification: PS-87427-0001
UL File No.: E29179
CSA File No.: LR19980
Mates With: 5557 dual row receptacle
Use With: 5556, 46083 and 45750 terminals

Electrical

Current: 12.0A max. (See applicable product specification.)
Voltage: 600V
Contact Resistance: 10 milliohms max.

Mechanical

Mating Cycles: 30 cycles

Physical

Housing: Nylon 4/6, UL 94V-0
Contact Material: Brass

Circuits	Order No.		Tail Length	Lead-free
	Tin Over Nickel Plating	Tin Over Copper Plating		
2	87427-0202	87427-0203	3.3mm	Yes
4	87427-0402	87427-0403		
6	87427-0602	87427-0603		
8	87427-0802	87427-0803		
10	87427-1002	87427-1003		
12	87427-1202	87427-1203		

Circuits	Order No.		Tail Length	Lead-free
	Tin Over Nickel Plating	Tin Over Copper Plating		
14	87427-1402	87427-1403	3.3mm	Yes
16	87427-1602	87427-1603		
18	87427-1802	87427-1803		
20	87427-2002	87427-2003		
22	87427-2202	87427-2203		
24	87427-2402	87427-2403		

4.20mm (.165") Pitch Mini-Fit Jr.™ Wire-to-Board Header

87427
Right Angle with Flange
High Temperature Material

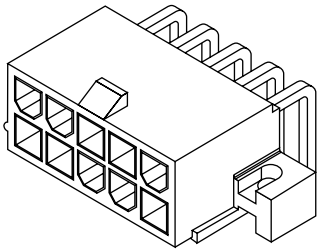

Features and Benefits

- Molded in high temperature, surface mount compatible material
- Fully isolated terminals to protect contacts from damage

Reference Information

Product Specification: PS-87427-0001
UL File No.: E29179
CSA File No.: LR19980
Mates With: 5557 dual row receptacle
Use With: 5556, 46083 and 45750 terminals

Electrical

Current: 12.0A max. (See applicable product specification.)
Voltage: 600V
Contact Resistance: 10 milliohms max.

Mechanical

Mating Cycles: 30 cycles

Physical

Housing: 4/6 Nylon, UL 94V-0
Contact Material: Brass

Circuits	Order No.		Tail Length	Lead-free
	Tin Over Nickel Plating	Tin Over Copper Plating		
2	87427-0212	87427-0213	3.3mm	Yes
4	87427-0412	87427-0413		
6	87427-0612	87427-0613		
8	87427-0812	87427-0813		
10	87427-1012	87427-1013		
12	87427-1212	87427-1213		

Circuits	Order No.		Tail Length	Lead-free
	Tin Over Nickel Plating	Tin Over Copper Plating		
14	87427-1412	87427-1413	3.3mm	Yes
16	87427-1612	87427-1613		
18	87427-1812	87427-1813		
20	87427-2012	87427-2013		
22	87427-2212	87427-2213		
24	87427-2412	87427-2413		

10.00mm (.393") Pitch Mini-Fit Sr.™

- Wire-to-Wire (free hanging and panel mount)
- Wire-to-Board
- Mandatory Terminal Position Assurance (TPA) Piece

- Voltage: 600V
- Current: 50.0A max.*

A

Transportation Products

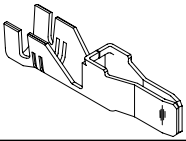
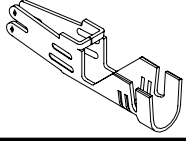
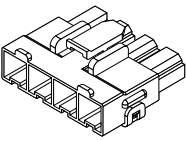
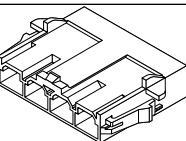
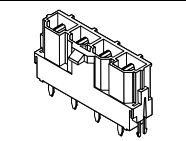
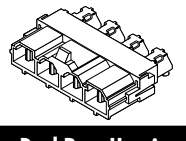
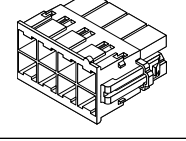
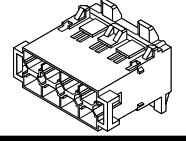
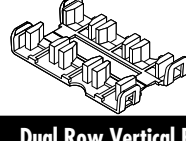
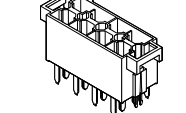
	Series	Description	Mates With/ Use With	Material	Circuits/ Wire Gauge	Features and Benefits
Terminals						
	42817	Male Terminal	Mates with 42815 Terminal Used in 42818 and 43938 Housings	Tin or Select Gold-plated Copper Alloy	8 to 16 AWG	<ul style="list-style-type: none"> • Mating Cycles—Tin: 30/Gold: 100 • Four points of electrical contact provide high reliability • Low insertion force design for greater ease in assembly
	42815	Female Terminal	Mates with 42817 Terminal and PCB Header Terminal Used in 42816 and 43914 Housings			
Single Row Housings						
	42816	Receptacle Housing	Mates with 42818, 42819, 42820	Black Polyester, UL 94V-0	2, 3, 4, 5 and 6 Circuits	<ul style="list-style-type: none"> • TPA (Terminal Position Assurance) piece attached to housing to prevent terminal backouts • Positive latch guards against accidental disengagement of housings • Polarized housing helps prevent improper mating • Used in wire-to-wire and wire-to-board applications
	42818	Plug Housing	Mates with 42816			
Single Row PC Board Headers						
	42819	Vertical Header	Mates with 42816	Housings: Black Glass-filled 4/6 Nylon, UL 94V-0 Terminals: Tin or Select Gold-plated Copper Alloy	2, 3, 4, 5 and 6 Circuits	<ul style="list-style-type: none"> • Metal forklocks for secure retention to PC board • Accommodates 1.57, 2.36, 3.18 and 6.35mm (.062, .093, .125 and .250") thick PC Boards
	42820	Right Angle Header				
Dual Row Housings						
	43914	Receptacle Housing	Mates with 43938, 43915 Use with 43980	Black Polyester, UL 94V-0	6, 8, 10, 12 and 14 Circuits	<ul style="list-style-type: none"> • Mandatory TPA (Terminal Position Assurance) piece (43980 series) sold separately • Positive latch guards against accidental disengagement of housings • Polarized housing helps prevent improper mating • Used in wire-to-wire or wire-to-board applications
	43938	Plug Housing	Mates with 43914 Use with 43980			
Dual Row TPA (Terminal Position Assurance Piece)						
	43980	TPA	Must Use With 43914, 43938	White Polyester, UL 94V-0	6, 8, 10, 12 and 14 Circuits	<ul style="list-style-type: none"> • Virtually eliminates terminal back out • White color for easy activation identification
Dual Row Vertical PC Board Header						
	43915	Vertical Header	Mates with 43914	Housing: Black Glass-filled 4/6 Nylon, UL 94V-0 Terminals: Tin or Select Gold-plated Copper Alloy	6, 8, 10, 12 and 14 Circuits	<ul style="list-style-type: none"> • Metal forklocks for secure retention to PC board • Accommodates 1.57, 2.36, 3.18 and 6.35mm (.062, .093, .125 and .250")

*Maximum current is dependent on wire gauge and circuit size. See Mini-Fit, Sr. product specification PS-42815-001.

10.00mm (.393") Pitch Mini-Fit Sr.™ Terminal

42815 Female

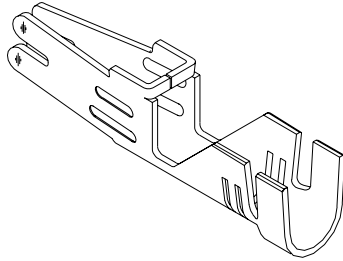

Features and Benefits

- High current
- Low engagement force
- Wire-to-wire, wire-to-board
- Four points of electrical contact

Reference Information

Product Specification: PS-42815-0001
 Packaging: Reel
 UL File No.: E29179
 CSA File No.: LR19980
 TUV License No.: R9751144
 Use With: 42816 and 43914 receptacle housings
 Designed In: Millimeters

Electrical

Voltage: 600V
 Current: 50.0A max.*
 Contact Resistance: 1.5 milliohms max.
 Dielectric Withstanding Voltage: 2200V
 Insulation Resistance: 1000 Megohms min.

Mechanical

Contact Insertion Force: 29.4N max.
 Contact Retention to Housing: 98.1N min.
 Mating Force: 29.4N max.
 Unmating Force: 4.9N min.
 Normal Force: 1.96N min.
 Durability: Tin—30 cycles; Gold—100 cycles

Physical

Contact: Copper Alloy
 Plating: Tin or Select Gold
 Wire gauge: 8, 10, 12, 14, 16 AWG

* Depending on circuit size, wire gauge and PCB. Please refer to product specification.

Order No.	Plating*	Wire Size (AWG)	Lead-free
42815-0041	Tin	14-16	Yes
42815-0042	Select Gold		
42815-0011	Tin	10-12	
42815-0012	Select Gold		
42815-0031	Tin	8	
42815-0032	Select Gold		

* Select Gold plated terminals recommended. See product specification for additional information.

10.00mm (.393") Pitch Mini-Fit Sr.™ Terminal

42817 Male

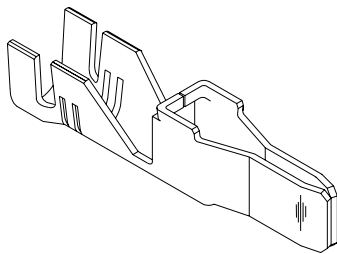

Features and Benefits

- High current
- Four points of electrical contact
- Low engagement force
- Wire-to-wire
- Grounding contacts available

Reference Information

Product Specification: PS-42815-0001
 Packaging: Reel
 UL File No.: E29179
 CSA File No.: LR19980
 TUV License No.: R9751144
 Use With: 42818 and 43938 plug housings
 Designed In: Millimeters

Electrical

Voltage: 600V
 Current: 50.0A max.*
 Contact Resistance: 1.5 milliohms max.
 Dielectric Withstanding Voltage: 2200V
 Insulation Resistance: 1000 Megohms min.

Mechanical

Contact Insertion Force: 29.4N max.
 Contact Retention to Housing: 98.1N min.
 Mating Force: 29.4N max.
 Unmating Force: 4.9N min.
 Normal Force: 1.96N min.
 Durability: Tin—30 cycles; Select Gold—100 cycles

Physical

Contact: Copper Alloy
 Plating: Tin or Select Gold
 Wire gauge: 8, 10, 12, 14 and 16 AWG

* Depending on circuit size and wire gauge. Please refer to product specification.

Standard Contacts			
Order No.	Plating*	Wire Gauge	Lead-free
42817-0041	Tin	14-16	Yes
42817-0042	Select Gold		
42817-0011	Tin	10-12	
42817-0012	Select Gold		
42817-0031	Tin	8	
42817-0032	Select Gold		

* Select Gold plated terminals recommended. See product specification for additional information.

Grounding Contacts			
Order No.	Plating*	Wire Gauge	Lead-free
42817-0141	Tin	14-16	Yes
42817-0142	Select Gold		
42817-0111	Tin	10-12	
42817-0112	Select Gold		
42817-0131	Tin	8	
42817-0132	Select Gold		

10.00mm (.393") Pitch Mini-Fit Sr.™ Receptacle Housing

42816
Single Row

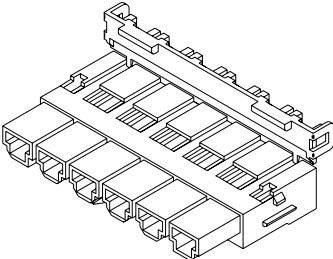

Circuits	Order No.
2	42816-0212
3	42816-0312
4	42816-0412
5	42816-0512
6	42816-0612

Features and Benefits

- High current
- Fully polarized
- Positive locks
- Low engagement force
- Wire-to-wire, wire-to-board
- Includes mandatory Terminal Position Assurance (TPA) clip

Reference Information

Product Specification: PS-42815-0001
 Packaging: Bag
 UL File No.: E29179
 CSA File No.: LR19980
 TUV License No.: R9751144
 Mates With: 42818 plug housing, 42819 and 42820 headers
 Use With: 42815 female terminal
 Designed In: Millimeters

Electrical

Voltage: 600V
 Current: 50.0A max.*
 Insulation Resistance: 1000 Megohms min.

Mechanical

Contact Insertion Force: 29.4N max.
 Contact Retention to Housing: 98.1N min.

Physical

Housing: Polyester, UL 94V-0
 * Depending on circuit size, wire gauge and PCB. Please refer to product specification.

10.00mm (.393") Pitch Mini-Fit Sr.™ Plug Housing

42818
Panel Mount
Single Row

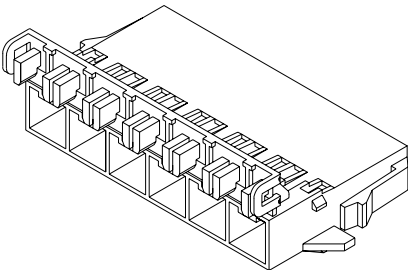

Circuits	Order No.
2	42818-0212
3	42818-0312
4	42818-0412
5	42818-0512
6	42818-0612

Features and Benefits

- High current
- Fully polarized
- Positive locks
- Low engagement force
- Wire-to-wire
- Panel Mountable
- Includes mandatory Terminal Position Assurance (TPA) clip

Reference Information

Product Specification: PS-42815-001
 Packaging: Bag
 UL File No.: E29179
 CSA File No.: LR19980
 TUV License No.: R9751144
 Mates With: 42816 receptacle housing
 Use With: 42817 male terminal
 Designed In: Millimeters

Electrical

Voltage: 600V
 Current: 50.0A max.*
 Insulation Resistance: 1000 Megohms min.

Mechanical

Contact Insertion Force: 29.4N max.
 Contact Retention to Housing: 98.1N min.

Physical

Housing: Polyester, UL 94V-0
 * Depending on circuit size and wire gauge. Please refer to product specification.

10.00mm (.393") Pitch Mini-Fit Sr.™ Header

42819

**Vertical, Single Row
Metal Clip Mount**

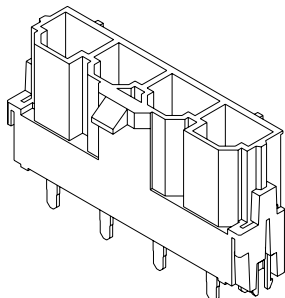

Features and Benefits

- High current
- Fully polarized
- Positive locks
- Low engagement force
- Wire-to-board
- Metal board retention clip

Reference Information

Product Specification: PS-42815-0001
 Packaging: Tray
 UL File No.: E29179
 CSA File No.: LR19980
 TUV License No.: R9751144
 Mates With: 42816 receptacle housing
 Designed In: Millimeters

Electrical

Voltage: 600V
 Current: 48.0A max.*
 Contact Resistance: 1.5 milliohms max.
 Dielectric Withstanding Voltage: 2200V
 Insulation Resistance: 1000 Megohms min.

Mechanical

Insertion Force to PCB: 19.6N max.
 Normal Force: 1.96N min.
 Durability: Tin—30 cycles; Gold—100 cycles

Physical

Housing: Glass-filled, 4/6 nylon, UL 94V-0
 Contact: Copper Alloy
 Plating: Tin or Select Gold
 PCB Thickness: 1.57, 2.36, 3.17, or 6.35mm
 (.062, .093, .125, or .250")

* Depending on circuit size, wire gauge and PCB. Please refer to product specification.

Circuits	Order No.		PCB Thickness	Retention Clip Length	PC Tail Length	Lead-free
	Tin*	Select Gold				
2	42819-2212	42819-2213	1.57 (.062)	1.80 (.070)	3.50 (.137)	Yes
	42819-2222	42819-2223	2.36 (.093)	2.60 (.102)	5.10 (.200)	
	42819-2232	42819-2233	3.18 (.125)	3.40 (.133)	8.30 (.327)	
	42819-2242	42819-2243	6.35 (.250)	6.58 (.259)	3.50 (.137)	
3	42819-3212	42819-3213	1.57 (.062)	1.80 (.070)	3.50 (.137)	
	42819-3222	42819-3223	2.36 (.093)	2.60 (.102)	5.10 (.200)	
	42819-3232	42819-3233	3.18 (.125)	3.40 (.133)	8.30 (.327)	
	42819-3242	42819-3243	6.35 (.250)	6.58 (.259)	3.50 (.137)	
4	42819-4212	42819-4213	1.57 (.062)	1.80 (.070)	3.50 (.137)	
	42819-4222	42819-4223	2.36 (.093)	2.60 (.102)	5.10 (.200)	
	42819-4232	42819-4233	3.18 (.125)	3.40 (.133)	8.30 (.327)	
	42819-4242	42819-4243	6.35 (.250)	6.58 (.259)	3.50 (.137)	
5	42819-5212	42819-5213	1.57 (.062)	1.80 (.070)	3.50 (.137)	
	42819-5222	42819-5223	2.36 (.093)	2.60 (.102)	5.10 (.200)	
	42819-5232	42819-5233	3.18 (.125)	3.40 (.133)	8.30 (.327)	
	42819-5242	42819-5243	6.35 (.250)	6.58 (.259)	3.50 (.137)	
6	42819-6212	42819-6213	1.57 (.062)	1.80 (.070)	3.50 (.137)	
	42819-6222	42819-6223	2.36 (.093)	2.60 (.102)	5.10 (.200)	
	42819-6232	42819-6233	3.18 (.125)	3.40 (.133)	8.30 (.327)	
	42819-6242	42819-6243	6.35 (.250)	6.58 (.259)	3.50 (.137)	

* Select Gold headers recommended. See product specification for additional information.

10.00mm (.393") Pitch Mini-Fit Sr.™ Header

42820

**Right Angle, Single Row
Metal Clip Mount**

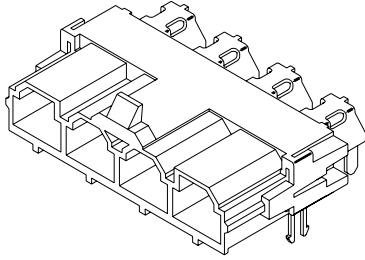

Features and Benefits

- High current
- Fully polarized
- Positive locks
- Low engagement force
- Wire-to-board
- Metal board retention clip

Reference Information

Product Specification: PS-42815-0001
 Packaging: Tray
 UL File No.: E29179
 CSA File No.: LR19980
 TUV License No.: R9751144
 Mates With: 42816 receptacle housing
 Designed In: Millimeters

Electrical

Voltage: 600V
 Current: 48.0A max.*
 Contact Resistance: 1.5 milliohms max.
 Dielectric Withstanding Voltage: 2200V
 Insulation Resistance: 1000 Megohms min.

Mechanical

Insertion Force to PCB: 19.6N max.
 Normal Force: 1.96N min.
 Durability: 30 cycles

Physical

Housing: Glass-filled, 4/6 nylon, UL 94V-0
 Contact: Copper Alloy
 Plating: Tin or Select Gold
 PCB Thickness: 1.57, 2.36, 3.18, or 6.35mm
 (.062, .093, .125, or .250")

* Depending on circuit size, wire gauge and PCB. Please refer to product specification.

Circuits	Order No.		PCB Thickness	Retention Clip Length	PC Tail Length	Lead-free
	Tin*	Select Gold				
2	42820-2212	42820-2213	1.57 (.062)	1.80 (.070)	3.50 (.137)	Yes
	42820-2222	42820-2223	2.36 (.093)	2.60 (.102)	5.10 (.200)	
	42820-2232	42820-2233	3.18 (.125)	3.40 (.133)		
	42820-2242	42820-2243	6.35 (.250)	6.58 (.259)	8.30 (.327)	
3	42820-3212	42820-3213	1.57 (.062)	1.80 (.070)	3.50 (.137)	
	42820-3222	42820-3223	2.36 (.093)	2.60 (.102)	5.10 (.200)	
	42820-3232	42820-3233	3.18 (.125)	3.40 (.133)		
	42820-3242	42820-3243	6.35 (.250)	6.58 (.259)	8.30 (.327)	
4	42820-4212	42820-4213	1.57 (.062)	1.80 (.070)	3.50 (.137)	
	42820-4222	42820-4223	2.36 (.093)	2.60 (.102)	5.10 (.200)	
	42820-4232	42820-4233	3.18 (.125)	3.40 (.133)		
	42820-4242	42820-4243	6.35 (.250)	6.58 (.259)	8.30 (.327)	
5	42820-5212	42820-5213	1.57 (.062)	1.80 (.070)	3.50 (.137)	
	42820-5222	42820-5223	2.36 (.093)	2.60 (.102)	5.10 (.200)	
	42820-5232	42820-5233	3.18 (.125)	3.40 (.133)		
	42820-5242	42820-5243	6.35 (.250)	6.58 (.259)	8.30 (.327)	
6	42820-6212	42820-6213	1.57 (.062)	1.80 (.070)	3.50 (.137)	
	42820-6222	42820-6223	2.36 (.093)	2.60 (.102)	5.10 (.200)	
	42820-6232	42820-6233	3.18 (.125)	3.40 (.133)		
	42820-6242	42820-6243	6.35 (.250)	6.58 (.259)	8.30 (.327)	

* Select Gold headers recommended. See product specification for additional information.

10.00mm (.393") Pitch Mini-Fit Sr.™ Receptacle and TPA Clip

43914/43980 Dual Row

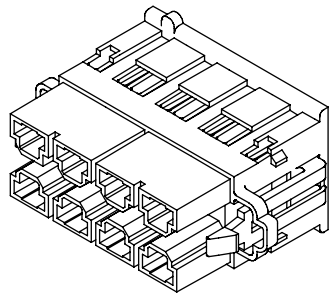

Features and Benefits

- High current
- Fully polarized
- Positive locks
- Low engagement force
- Wire-to-wire, wire-to-board (vertical only)
- Mandatory 43980 Series Terminal Position Assurance (TPA) clip, order separately

Reference Information

Product Specification: PS-42815-001
 Packaging: Bag
 UL File No.: E29179
 CSA File No.: LR19980
 TUV License No: R9751144
 Mates With: 43938 plug housing and 43915 header
 Use With: 42815 female terminal and 43980 Terminal Position Assurance (TPA) clip
 Designed In: Millimeters

Electrical

Voltage: 600V
 Current: 43.0A max*
 Insulation Resistance: 1000 Megohms min.
 Dielectric withstanding voltage: 2200V

Mechanical

Contact Insertion Force: 29.4N max.
 Contact Retention to Housing: 98.1N min.

Physical

Housing: Polyester, UL 94V-0
 *Depending on circuit size, wire gauge and PCB. Please refer to product specification.

Dual Row Receptacles		TPA Clip	
Circuits	Order No.	Circuits	Order No.
6	43914-1101	6	43980-1001
8	43914-1102	8	43980-1002
10	43914-1103	10	43980-1003
12	43914-1104	12	43980-1004
14	43914-1105	14	43980-1005

10.00mm (.393") Pitch Mini-Fit Sr.™ Plug and TPA Clip

43938/43980 Dual Row Panel Mount

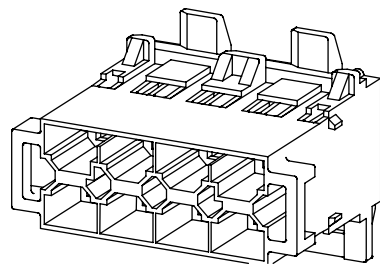

Features and Benefits

- High current
- Fully polarized
- Positive locks
- Low engagement force
- Wire-to-wire
- Mandatory 43980 Series Terminal Position Assurance (TPA) clip, order separately

Reference Information

Product Specification: PS-42815-001
 Packaging: Bag
 UL File No.: E29179
 CSA File No.: LR19980
 TUV License No: R9751144
 Mates With: 43914 Receptacle housing
 Use With: 42817 male terminal and 43980 Terminal Position Assurance (TPA) clip
 Designed In: Millimeters

Electrical

Voltage: 600V
 Current: 43.0A max*
 Insulation Resistance: 1000 Megohms min.
 Dielectric withstanding voltage: 2200V

Mechanical

Contact Insertion Force: 29.4N max.
 Contact Retention to Housing: 98.1N min.

Physical

Housing: Polyester, UL 94V-0
 *Depending on circuit size and wire gauge. Please refer to product specification.

Dual Row Plug		TPA Clip	
Circuits	Order No.	Circuits	Order No.
6	43938-2101	6	43980-1001
8	43938-2102	8	43980-1002
10	43938-2103	10	43980-1003
12	43938-2104	12	43980-1004
14	43938-2105	14	43980-1005

10.00mm (.393") Pitch Mini-Fit Sr.™ Header

43915

Vertical, Dual Row Metal Clip Mount

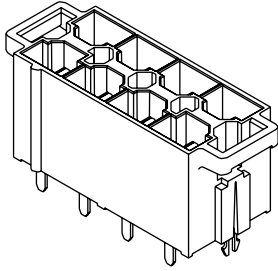

Features and Benefits

- High current
- Fully polarized
- Positive locks
- Low engagement force
- Metal board retention clips
- Wire-to-board

Reference Information

Product Specification: PS-42815-0001
Packaging: Tray
UL File No.: E29179
CSA File No.: LR19980
TUV License No: R9751144
Mates With: 43914 receptacle housing
Designed In: Millimeters

Electrical

Voltage: 600V
Current: 37.0A max.*
Contact Resistance: 1.5 milliohms max.
Dielectric Withstanding Voltage: 2200V
Insulation Resistance: 1000 Megohms min.

Mechanical

Insertion Force to PCB: 19.6kg max.
Normal Force: 1.96N min.
Durability: Tin—30 cycles; Gold—100 cycles

Physical

Housing: Glass-filled, 4/6 nylon, UL 94V-0
Contact: Copper Alloy
Plating: Tin or Select Gold
PCB Thickness: 1.57, 2.36, 3.18 or 6.35mm
(.062, .093, .125 or .250")

* Depending on circuit size, wire gauge and PCB. Please refer to product specification.

Circuits	Order No.		PCB Thickness	Lead-free
	Tin*	Select Gold		
6	43915-1101	43915-1201	1.57 (.062)	Yes
	43915-1106	43915-1206	2.36 (.093)	
	43915-1111	43915-1211	3.18 (.125)	
	43915-1116	43915-1216	6.35 (.250)	
8	43915-1102	43915-1202	1.57 (.062)	
	43915-1107	43915-1207	2.36 (.093)	
	43915-1112	43915-1212	3.18 (.125)	
	43915-1117	43915-1217	6.35 (.250)	
10	43915-1103	43915-1203	1.57 (.062)	
	43915-1108	43915-1208	2.36 (.093)	
	43915-1113	43915-1213	3.18 (.125)	
	43915-1118	43915-1218	6.35 (.250)	

* Select Gold headers recommended. See product specification for additional information.

Circuits	Order No.		PCB Thickness	Lead-free
	Tin*	Select Gold		
12	43915-1104	43915-1204	1.57 (.062)	Yes
	43915-1109	43915-1209	2.36 (.093)	
	43915-1114	43915-1214	3.18 (.125)	
	43915-1119	43915-1219	6.35 (.250)	
14	43915-1105	43915-1205	1.57 (.062)	
	43915-1110	43915-1210	2.36 (.093)	
	43915-1115	43915-1215	3.18 (.125)	
	43915-1120	43915-1220	6.35 (.250)	

4.20mm (.165") Pitch Mini-Fit H20™ IP67 Sealed Interconnect System Terminal

46055
Female

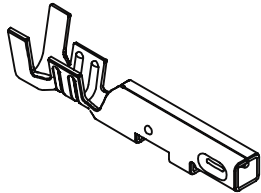

Order No.	Plating	Packaging
46055-0005	Tin	Reel
46055-0007		Bag
46055-0006	30µ" Select Gold	Reel
46055-0008		Bag

Features and Benefits

- Accepts 18 or 20 AWG wire
- Tin and gold plating options
- Post-plated contacts for superior performance

Reference Information

Packaging:
Terminals—Reel and Bag
Assemblies—Bag
UL File No.: E29179
CSA File No.: 1068385
For Use With: 46064 Receptacle

Electrical

Voltage: 600V max.
Current: 9.0A per circuit max.

Mechanical

Contact Insertion Force: 15N (3.372 lb)
Contact Retention to Housing: 20N (4.496 lb)
Mating Force: Tin—11.1N (2.495 lb) max.
Gold—4.4N (.989 lb) max.
Unmating Force: Tin—2.2N (.495 lb) min.
Gold—1.0N (.225) min.
Durability: Tin—75 cycles min.
Gold—100 cycles min.

Physical

Housing: Polyester, UL 94V-0
Contact: Copper Alloy
Plating: Contact Area—Tin or 30µ" Select Gold

4.20mm (.165") Pitch Mini-Fit H20™ IP67 Sealed Interconnect System Terminal

46056
Male

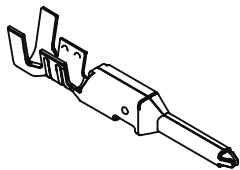

Order No.	Plating	Packaging
46056-0002	Tin	Reel
46056-0004		Bag
46056-0003	30µ" Select Gold	Reel
46056-0005		Bag

Features and Benefits

- Accepts 18 or 20 AWG wire
- Tin and gold plating options
- Post-plated contacts for superior performance

Reference Information

Packaging: Reel and Bag
UL File No.: E29179
CSA File No.: 1068385
For Use With: 46065 Plug

Electrical

Voltage: 600V max.
Current: 9.0A per circuit max.

Mechanical

Contact Insertion Force: 15N (3.372 lb)
Contact Retention to Housing: 20N (4.496 lb)
Mating Force: Tin—11.1N (2.495 lb) max.
Gold—4.4N (.989 lb) max.
Unmating Force: Tin—2.2N (.495 lb) min.
Gold—1.0N (.225) min.
Durability: Tin—75 cycles min.
Gold—100 cycles min.

Physical

Contact: Copper Alloy
Plating: Contact Area—Tin or 30µ" Select Gold

4.20mm (.165") Pitch Mini-Fit H20™ IP67 Sealed Interconnect System Plug

46065

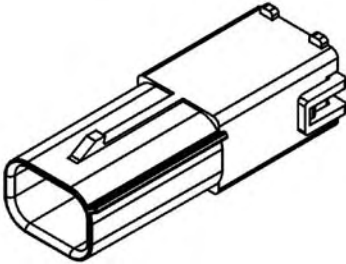

Circuits	Order No.
2	46065-0032

Features and Benefits

- IP67 rated
- Seals are pre-installed, lowering appreciation costs
- Made from UV-stabilized material that can be used in direct sunlight applications
- Positive lock prevents accidental unmating

Reference Information

Packaging: Bag
UL File No.: E29179
CSA File No.: 1068385

Electrical

Voltage: 600V max.
Current: 9.0A per circuit max.

Mechanical

Contact Insertion Force: 15N (3.372 lb)
Contact Retention to Housing: 20N (4.496 lb)
Mating Force: Tin—11.1N (2.495 lb) max.
Gold—4.4N (.989 lb) max.
Unmating Force: Tin—2.2N (.495 lb) min.
Gold—1.0N (.225) min.
Durability: Tin—75 cycles min.
Gold—100 cycles min.

Physical

Housing: UV Stabilized Polyester, UL 94V-0

4.20mm (.165") Pitch Mini-Fit H20™ IP67 Sealed Interconnect System Receptacle

46064

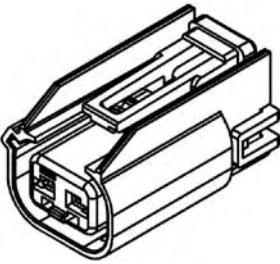

Circuits	Order No.
2	46064-0032

Features and Benefits

- IP67 rated
- Seals are pre-installed, lowering appreciation costs
- Made from UV-stabilized material that can be used in direct sunlight applications
- Positive lock prevents accidental unmating

Reference Information

Packaging: Bag
UL File No.: E29179
CSA File No.: 1068385

Electrical

Voltage: 600V max.
Current: 9.0A per circuit max.

Mechanical

Contact Insertion Force: 15N (3.372 lb)
Contact Retention to Housing: 20N (4.496 lb)
Mating Force: Tin—11.1N (2.495 lb) max.
Gold—4.4N (.989 lb) max.
Unmating Force: Tin—2.2N (.495 lb) min.
Gold—1.0N (.225) min.
Durability: Tin—75 cycles min.
Gold—100 cycles min.

Physical

Housing: UV Stabilized Polyester, UL 94V-0

3.00mm (.118") Pitch Micro-Fit 3.0™ Terminal

43030
Female

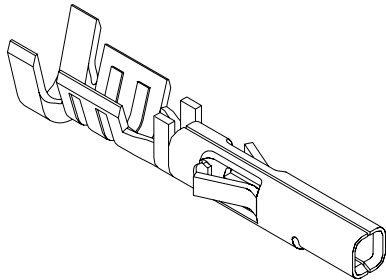

Features and Benefits

- 4 points of contact for optimum reliability
- Box-type spring contact for high normal force
- Locking tang secures terminal in housing

Reference Information

Product Specification: PS-43045/PS-43650
 Packaging: Bag or reel
 UL File No.: E29179
 CSA File No.: LR19980
 TUV License No.: R72040445
 Use With: 43025, 43645 and 44133 receptacles
 Designed In: Millimeters

Electrical

Voltage: 250V
 Current: 5.0A max.
 Contact Resistance: 30 milliohms max.

Mechanical

Contact Insertion Force: 1.5kgf max. (3.30 lb)
 Contact Retention to Housing: 2.5kgf min. (5.50 lb)
 Crimping Pull-Out Force:

Wire Gauge (AWG)	Kgf min. (lb)
20	5.8 (13.0)
22	3.6 (8.0)
24	2.2 (5.0)
26	1.3 (3.0)
28	0.9 (2.0)
30	0.7 (1.5)

Mating Force: 0.8kgf max. (1.8 lb) per contact
 Normal Force: 275gf max. (0.6 lb)

Physical

Contact: Phosphor Bronze
 Plating: Tin or Gold

Wire Size AWG	Plating	Order No.		Lead-free
		Reel	Bag	
20-24	Tin	43030-0001	43030-0007	Yes
26-30		43030-0004	43030-0010	
20-24	15µ" Gold	43030-0002	43030-0008	
26-30		43030-0005	43030-0011	
20-24	30µ" Gold	43030-0003	43030-0009	
26-30		43030-0006	43030-0012	

3.00mm (.118") Pitch Micro-Fit 3.0™ Terminal

43031
Male

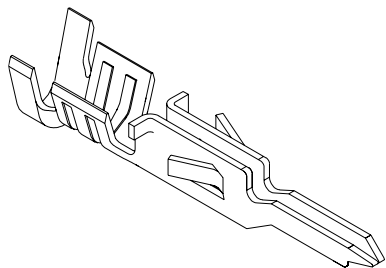

Features and Benefits

- Box-type spring contact for high normal force
- Locking tang secures terminal in housing

Reference Information

Product Specification: PS-43045/PS-43650
 Packaging: Bag or reel
 UL File No.: E29179
 CSA File No.: LR19980
 TUV License No.: R72040445
 Use With: 43020, 43640 and 44300 plugs
 Designed In: Millimeters

Electrical

Voltage: 250V
 Current: 5.0A max.
 Contact Resistance: 30 milliohms max.

Mechanical

Contact Insertion Force: 1.5kgf max. (3.30 lb)
 Contact Retention to Housing: 2.5kgf min. (5.50 lb)
 Crimping Pull-Out Force:

Wire Gauge	Kgf min. (lb)
20	5.8 (13.0)
22	3.6 (8.0)
24	2.2 (5.0)
26	1.3 (3.0)
28	0.9 (2.0)
30	0.7 (1.5)

Physical

Contact: Phosphor Bronze
 Plating: Tin or Gold

Wire Size AWG	Plating	Order No.		Lead-free
		Reel	Bag	
20-24	Tin	43031-0001	43031-0007	Yes
26-30		43031-0004	43031-0010	
20-24	15µ" Gold	43031-0002	43031-0008	
26-30		43031-0005	43031-0011	
20-24	30µ" Gold	43031-0003	43031-0009	
26-30		43031-0006	43031-0012	

3.00mm (.118") Pitch Micro-Fit 3.0™ Wire-to-Wire Receptacle

43645
Single Row

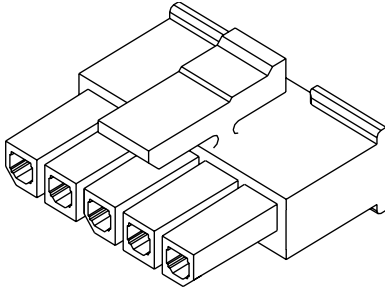

Features and Benefits

- Positive latching to mating headers or plugs
- Fully isolated contacts
- Fully polarized to mating headers and plugs
- Integral pull tabs for ease in unmating

Reference Information

Product Specification: PS-43650
 Packaging: Bag
 UL File No.: E29179
 CSA File No.: LR19980
 TUV License No.: R72040445
 Mates With: 43640 and 43650
 Use With: 43030
 Designed In: Millimeters

Physical

Housing: Polyester, UL 94V-0

Circuits	Order No.
2	43645-0200
3	43645-0300
4	43645-0400
5	43645-0500
6	43645-0600
7	43645-0700

Circuits	Order No.
8	43645-0800
9	43645-0900
10	43645-1000
11	43645-1100
12	43645-1200

3.00mm (.118") Pitch Micro-Fit 3.0™ Wire-to-Wire Plug

43640
Single Row, with or without
Panel Mount Ears

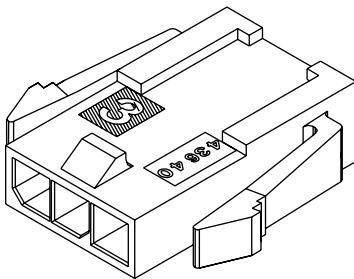

Features and Benefits

- Fully isolated contacts
- Fully polarized to mating receptacle
- Integral pull tabs for ease in unmating
- Optional panel mount ears

Reference Information

Product Specification: PS-43650
 Packaging: Bag
 UL File No.: E29179
 CSA File No.: LR19980
 TUV License No.: R72040445
 Mates With: 43645
 Use With: 43031
 Designed In: Millimeters

Physical

Housing: Polyester, UL 94V-0

Circuits	Order No.	
	Panel Mount	Free Hanging
2	43640-0200	43640-0201
3	43640-0300	43640-0301
4	43640-0400	43640-0401
5	43640-0500	43640-0501
6	43640-0600	43640-0601
7	43640-0700	43640-0701

Circuits	Order No.	
	Panel Mount	Free Hanging
8	43640-0800	43640-0801
9	43640-0900	43640-0901
10	43640-1000	43640-1001
11	43640-1100	43640-1101
12	43640-1200	43640-1201

3.00mm (.118") Pitch Micro-Fit 3.0™ Wire-to-Board Header

43650
Single Row, Vertical
With Solderable Retention Clip

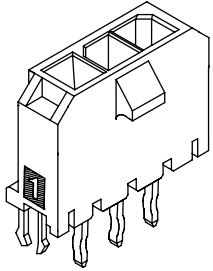

Features and Benefits

- Offset terminal retention for optimum retention to PC board during wave soldering
- Fully polarized to mating receptacle
- Solderable retention clip provides optimum retention to PCB
- Surface Mount Compatible

Reference Information

Product Specification: PS-43650
Packaging: Tray
UL File No.: E29179
CSA File No.: LR19980A
TUV License No.: R72040445
Mates With: 43645
Designed In: Millimeters

Electrical

Voltage: 250V
Current: 5.0A max.
Contact Resistance: 30 milliohms max.
Dielectric Withstanding Voltage: 1500V AC
Insulation Resistance: 1000 Megohms min.

Physical

Housing: LCP, UL 94V-0
Contact: Brass
Plating: Tin or Gold

Circuits	Order No.			Lead-free
	Tin	15µm Gold	30µm Gold	
2	43650-0218	43650-0219	43650-0220	Yes
3	43650-0318	43650-0319	43650-0320	
4	43650-0418	43650-0419	43650-0420	
5	43650-0518	43650-0519	43650-0520	
6	43650-0618	43650-0619	43650-0620	
7	43650-0718	43650-0719	43650-0720	
8	43650-0818	43650-0819	43650-0820	
9	43650-0918	43650-0919	43650-0920	
10	43650-1018	43650-1019	43650-1020	
11	43650-1118	43650-1119	43650-1120	
12	43650-1218	43650-1219	43650-1220	

3.00mm (.118") Pitch Micro-Fit 3.0™ Wire-to-Board Header

43650
Single Row, Vertical, SMT
With Solderable Retention Clip

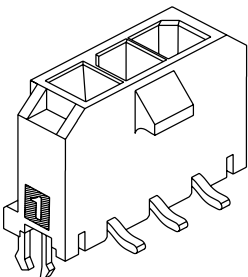

Features and Benefits

- Solderable retention clip provides optimum retention to PCB
- Fully polarized to mating receptacle
- Tape and reel packaging eliminates handling and provides for higher insertion speeds compared to tray packing or hand assembly

Reference Information

Product Specification: PS-43650
Packaging: Tape and reel
UL File No.: E29179
CSA File No.: LR19980A
TUV License No.: R72040445
Mates With: 43645
Designed In: Millimeters

Electrical

Voltage: 250V
Current: 5.0A max.
Contact Resistance: 30 milliohms max.
Dielectric Withstanding Voltage: 1500V AC
Insulation Resistance: 1000 Megohms min.

Physical

Housing: High temperature LCP, UL 94V-0
Contact: Brass
Plating: Tin or Gold

Circuits	Order No.			Lead-free
	Tin	15µm Gold	30µm Gold	
2	43650-0221	43650-0222	43650-0223	Yes
3	43650-0321	43650-0322	43650-0323	
4	43650-0421	43650-0422	43650-0423	
5	43650-0521	43650-0522	43650-0523	
6	43650-0621	43650-0622	43650-0623	
7	43650-0721	43650-0722	43650-0723	

Circuits	Order No.			Lead-free
	Tin	15µm Gold	30µm Gold	
8	43650-0821	43650-0822	43650-0823	Yes
9	43650-0921	43650-0922	43650-0923	
10	43650-1021	43650-1022	43650-1023	
11	43650-1121	43650-1122	43650-1123	
12	43650-1221	43650-1222	43650-1223	

3.00mm (.118") Pitch Micro-Fit 3.0™ Wire-to-Board Header

43650
Single Row, Vertical, SMT
With Solderable Fitting Nail

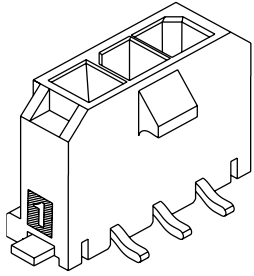

Features and Benefits

- Solder tabs provide retention to PCB
- Fully polarized to mating receptacle
- Tape and reel packaging eliminates handling and provides for higher insertion speeds compared to tray packing or hand assembly

Reference Information

Product Specification: PS-43650
Packaging: Tape and reel
UL File No.: E29179
CSA File No.: LR19980A
TUV License No.: R72040445
Mates With: 43645
Designed In: Millimeters

Electrical

Voltage: 250V
Current: 5.0A max.
Contact Resistance: 30 milliohms max.
Dielectric Withstanding Voltage: 1500V AC
Insulation Resistance: 1000 Megohms min.

Physical

Housing: High temperature LCP, UL 94V-0
Contact: Brass
Plating: Tin or Gold

Circuits	Order No.			Lead-free
	Tin	15" Gold	30" Gold	
2	43650-0224	43650-0225	43650-0226	Yes
3	43650-0324	43650-0325	43650-0326	
4	43650-0424	43650-0425	43650-0426	
5	43650-0524	43650-0525	43650-0526	
6	43650-0624	43650-0625	43650-0626	
7	43650-0724	43650-0725	43650-0726	

Circuits	Order No.			Lead-free
	Tin	15" Gold	30" Gold	
8	43650-0824	43650-0825	43650-0826	Yes
9	43650-0924	43650-0925	43650-0926	
10	43650-1024	43650-1025	43650-1026	
11	43650-1124	43650-1125	43650-1126	
12	43650-1224	43650-1225	43650-1226	

3.00mm (.118") Pitch Micro-Fit 3.0™ Wire-to-Board Header

43650
Single Row
Right Angle

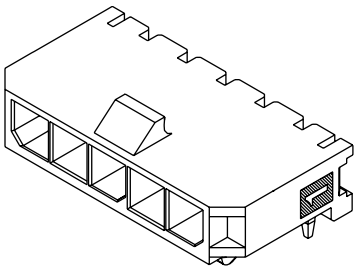

Features and Benefits

- Snap-in peg locks header to PCB for optimum retention
- Fully polarized to mating receptacle
- Surface Mount Compatible

Reference Information

Product Specification: PS-43650
Packaging: Tray
UL File No.: E29179
CSA File No.: LR19980
TUV License No.: R72040445
Mates With: 43645
Designed In: Millimeters

Electrical

Voltage: 250V
Current: 5.0A max.
Contact Resistance: 30 milliohms max.
Dielectric Withstanding Voltage: 1500V AC
Insulation Resistance: 1000 Megohms min.

Physical

Housing: High temperature LCP, UL 94V-0
Contact: Brass
Plating: Tin or Gold

Circuits	Order No.			Lead-free
	Tin	15µ" Gold	30µ" Gold	
2	43650-0200	43650-0201	43650-0202	Yes
3	43650-0300	43650-0301	43650-0302	
4	43650-0400	43650-0401	43650-0402	
5	43650-0500	43650-0501	43650-0502	
6	43650-0600	43650-0601	43650-0602	
7	43650-0700	43650-0701	43650-0702	

Circuits	Order No.			Lead-free
	Tin	15µ" Gold	30µ" Gold	
8	43650-0800	43650-0801	43650-0802	Yes
9	43650-0900	43650-0901	43650-0902	
10	43650-1000	43650-1001	43650-1002	
11	43650-1100	43650-1101	43650-1102	
12	43650-1200	43650-1201	43650-1202	

3.00mm (.118") Pitch Micro-Fit 3.0™ Wire-to-Board Header

43650
Single Row
Right Angle

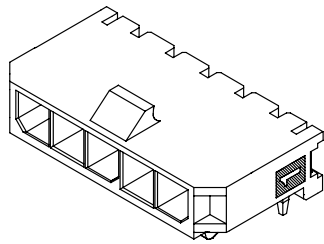

Features and Benefits

- "Offset Terminal Retention" for optimum retention to PC board during wave soldering
- Fully polarized to mating receptacle
- Peg feature provides polarization to PCB
- Surface Mount Compatible

Reference Information

Product Specification: PS-43650
Packaging: Tray
UL File No.: E29179
CSA File No.: LR19980
TUV License No.: R72040445
Mates With: 43645
Designed In: Millimeters

Electrical

Voltage: 250V
Current: 5.0A max.
Contact Resistance: 30 milliohms max.
Dielectric Withstanding Voltage: 1500V AC
Insulation Resistance: 1000 Megohms min.

Mechanical

Insertion Force to PCB: 7.5kgf max. (16.5 lb)

Physical

Housing: High temperature LCP, UL 94V-0
Contact: Brass
Plating: Tin or Gold

Circuits	Order No.						Lead-free
	Standard "OTR" Version			Straight Tail Version			
	Tin	15µ" Gold	30µ" Gold	Tin	15µ" Gold	30µ" Gold	
2	43650-0215	43650-0216	43650-0217	43650-0227	43650-0228	43650-0229	Yes
3	43650-0315	43650-0316	43650-0317	43650-0327	43650-0328	43650-0329	
4	43650-0415	43650-0416	43650-0417	43650-0427	43650-0428	43650-0429	
5	43650-0515	43650-0516	43650-0517	43650-0527	43650-0528	43650-0529	
6	43650-0615	43650-0616	43650-0617	43650-0627	43650-0628	43650-0629	
7	43650-0715	43650-0716	43650-0717	43650-0727	43650-0728	43650-0729	
8	43650-0815	43650-0816	43650-0817	43650-0827	43650-0828	43650-0829	
9	43650-0915	43650-0916	43650-0917	43650-0927	43650-0928	43650-0929	
10	43650-1015	43650-1016	43650-1017	43650-1027	43650-1028	43650-1029	
11	43650-1115	43650-1116	43650-1117	43650-1127	43650-1128	43650-1129	
12	43650-1215	43650-1216	43650-1217	43650-1227	43650-1228	43650-1229	

3.00mm (.103") Pitch Micro-Fit 3.0™ Wire-to-Board Header

43650
Single Row, Right Angle
With Solderable Retention Clip

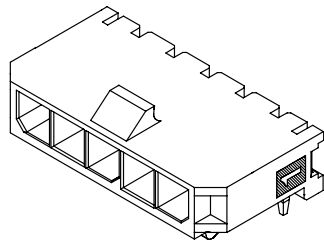

Features and Benefits

- Solderable clip provides optimum retention to PCB
- Fully polarized to mating receptacle
- Surface Mount Compatible

Reference Information

Product Specification: PS-43650
Packaging: Tray
UL File No.: E29179
CSA File No.: LR04980A
TUV License No.: R72040445
Mates With: 43645
Designed In: Millimeters

Electrical

Voltage: 250V
Current: 5.0A max.
Contact Resistance: 30 milliohms max.
Dielectric Withstanding Voltage: 1500V AC
Insulation Resistance: 1000 Megohms min.

Mechanical

Insertion Force to PCB: 7.5kgf max. (16.5 lb)

Physical

Housing: High temperature LCP, UL 94V-0
Contact: Brass
Plating: Tin or Gold

Circuits	Order No.			Lead-free
	Tin	15µ" Gold	30µ" Gold	
2	43650-0203	43650-0204	43650-0205	Yes
3	43650-0303	43650-0304	43650-0305	
4	43650-0403	43650-0404	43650-0405	
5	43650-0503	43650-0504	43650-0505	
6	43650-0603	43650-0604	43650-0605	
7	43650-0703	43650-0704	43650-0705	
8	43650-0803	43650-0804	43650-0805	
9	43650-0903	43650-0904	43650-0905	
10	43650-1003	43650-1004	43650-1005	
11	43650-1103	43650-1104	43650-1105	
12	43650-1203	43650-1204	43650-1205	

3.00mm (.118") Pitch Micro-Fit 3.0™ Wire-to-Board Header

43650
Single Row, Right Angle, SMT
With Solderable Retention Clip

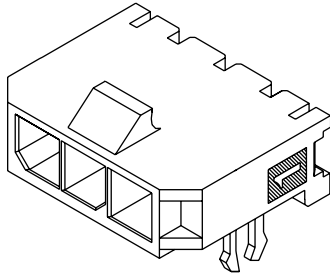

Features and Benefits

- Solderable retention clip provides optimum retention to PCB
- Fully polarized to mating receptacle
- Tape and reel packaging eliminates handling and provides higher insertion speed compared to tray packing or hand assembly

Reference Information

Product Specification: PS-43650
Packaging: Tape and reel
UL File No.: E29179
CSA File No.: LR19980A
TUV License No.: R72040445
Mates With: 43645
Designed In: Millimeters

Electrical

Voltage: 250V
Current: 5.0A max.
Contact Resistance: 30 milliohms max.
Dielectric Withstanding Voltage: 1500V AC
Insulation Resistance: 1000 Megohms min.

Mechanical

Insertion Force to PCB: 7.5kgf max. (16.5 lb)

Physical

Housing: High temperature LCP, UL 94V-0
Contact: Brass
Plating: Tin or Gold

Circuits	Order No.			Lead-free
	Tin	15µm Gold	30µm Gold	
2	43650-0209	43650-0210	43650-0211	Yes
3	43650-0309	43650-0310	43650-0311	
4	43650-0409	43650-0410	43650-0411	
5	43650-0509	43650-0510	43650-0511	
6	43650-0609	43650-0610	43650-0611	
7	43650-0709	43650-0710	43650-0711	

Circuits	Order No.			Lead-free
	Tin	15µm Gold	30µm Gold	
8	43650-0809	43650-0810	43650-0811	Yes
9	43650-0909	43650-0910	43650-0911	
10	43650-1009	43650-1010	43650-1011	
11	43650-1109	43650-1110	43650-1111	
12	43650-1209	43650-1210	43650-1211	

3.00mm (.118") Pitch Micro-Fit 3.0™ Wire-to-Board Header

43650
Single Row, Right Angle, SMT
With Solderable Fitting Nail

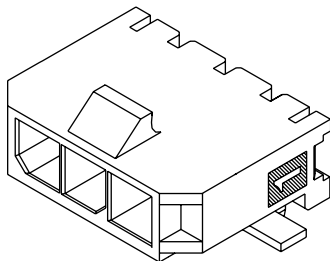

Features and Benefits

- Solder tabs provide retention to PCB
- Fully polarized to mating receptacle
- Tape and reel packaging eliminates handling and provides higher insertion speeds compared to tray packing or hand assembly

Reference Information

Product Specification: PS-43650
Packaging: Tape and reel for robotic placement
UL File No.: E29179
CSA File No.: LR19980A
TUV License No.: R72040445
Mates With: 43645
Designed In: Millimeters

Electrical

Voltage: 250V
Current: 5.0A max.
Contact Resistance: 30 milliohms max.
Dielectric Withstanding Voltage: 1500V AC
Insulation Resistance: 1000 Megohms min.

Physical

Housing: High temperature LCP, UL 94V-0
Contact: Brass
Plating: Tin or Gold

Circuits	Order No.			Lead-free
	Tin	15µm Gold	30µm Gold	
2	43650-0212	43650-0213	43650-0214	Yes
3	43650-0312	43650-0313	43650-0314	
4	43650-0412	43650-0413	43650-0414	
5	43650-0512	43650-0513	43650-0514	
6	43650-0612	43650-0613	43650-0614	
7	43650-0712	43650-0713	43650-0714	

Circuits	Order No.			Lead-free
	Tin	15µm Gold	30µm Gold	
8	43650-0812	43650-0813	43650-0814	Yes
9	43650-0912	43650-0913	43650-0914	
10	43650-1012	43650-1013	43650-1014	
11	43650-1112	43650-1113	43650-1114	
12	43650-1212	43650-1213	43650-1214	

3.00mm (.118") Pitch Micro-Fit 3.0™ Wire-to-Wire Receptacle

43025
Dual Row

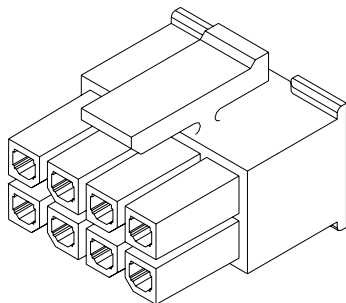

Features and Benefits

- Positive latching to mating headers or plugs
- Fully isolated contacts
- Fully polarized to mating headers and plugs
- Integral pull tabs for ease in unmating

Reference Information

Product Specification: PS-43045
 Packaging: Bag
 UL File No.: E29179
 CSA File No.: LR19980
 TUV License No.: R72040445
 Mates With: 43020, 43045 and 44914
 Use With: 43030
 Designed In: Millimeters

Physical

Housing: Polyester, UL 94V-0

Circuits	Order No.
2	43025-0200
4	43025-0400
6	43025-0600
8	43025-0800
10	43025-1000
12	43025-1200

Circuits	Order No.
14	43025-1400
16	43025-1600
18	43025-1800
20	43025-2000
22	43025-2200
24	43025-2400

3.00mm (.118") Pitch Micro-Fit 3.0™ Wire-to-Wire Plug

43020
Dual Row, with or without
Panel Mount Ears

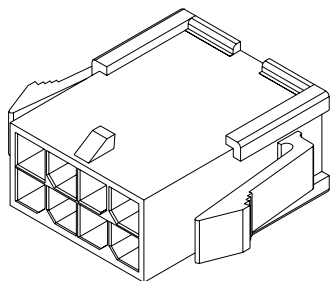

Features and Benefits

- Fully isolated contacts
- Fully polarized to mating receptacle
- Integral pull tabs for ease in unmating
- Optional panel mount ears

Reference Information

Product Specification: PS-43045
 Packaging: Bag
 UL File No.: E29179
 CSA File No.: LR19980
 TUV License No.: R72040445
 Mates With: 43025
 Use With: 43031
 Designed In: Millimeters

Physical

Housing: Polyester, UL 94V-0

Circuits	Order No.	
	Panel Mount	Free Hanging
2	43020-0201	43020-0201
4	43020-0401	43020-0401
6	43020-0601	43020-0601
8	43020-0801	43020-0801
10	43020-1001	43020-1001
12	43020-1201	43020-1201

Circuits	Order No.	
	Panel Mount	Free Hanging
14	43020-1401	43020-1401
16	43020-1601	43020-1601
18	43020-1801	43020-1801
20	43020-2001	43020-2001
22	43020-2201	43020-2201
24	43020-2401	43020-2401

3.00mm (.118") Pitch Micro-Fit 3.0™ Wire-to-Board Header

43045
Dual Row
Vertical

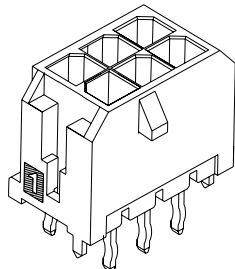

Features and Benefits

- "Offset Terminal Retention" for optimum retention to PC board during wave soldering
- Fully polarized to mating receptacle
- Peg feature provides polarization to PCB
- Surface Mount Compatible

Reference Information

Product Specification: PS-43045
Packaging: Tray
UL File No.: E29179
CSA File No.: LR19980
TUV License No.: R72040445
Mates With: 43025
Designed In: Millimeters

Electrical

Voltage: 250V
Current: 5.0A max.
Contact Resistance: 30 milliohms max.
Dielectric Withstanding Voltage: 1500V AC
Insulation Resistance: 1000 Megohms min.

Mechanical

Insertion Force to PCB: 7.5kgf max. (16.5 lb)

Physical

Housing: High temperature LCP, UL 94V-0
Contact: Brass
Plating: Tin or Gold

Circuits	Order No.						Lead-free
	Standard "OTR" Version			Straight Tail Version			
	Tin	15µ" Gold	30µ" Gold	Tin	15µ" Gold	30µ" Gold	
2	43045-0212	43045-0213	43045-0214	43045-0227	43045-0228	43045-0229	Yes
4	43045-0412	43045-0413	43045-0414	43045-0427	43045-0428	43045-0429	
6	43045-0612	43045-0613	43045-0614	43045-0627	43045-0628	43045-0629	
8	43045-0812	43045-0813	43045-0814	43045-0827	43045-0828	43045-0829	
10	43045-1012	43045-1013	43045-1014	43045-1027	43045-1028	43045-1029	
12	43045-1212	43045-1213	43045-1214	43045-1227	43045-1228	43045-1229	
14	43045-1412	43045-1413	43045-1414	43045-1427	43045-1428	43045-1429	
16	43045-1612	43045-1613	43045-1614	43045-1627	43045-1628	43045-1629	
18	43045-1812	43045-1813	43045-1814	43045-1827	43045-1828	43045-1829	
20	43045-2012	43045-2013	43045-2014	43045-2027	43045-2028	43045-2029	
22	43045-2212	43045-2213	43045-2214	43045-2227	43045-2228	43045-2229	
24	43045-2412	43045-2413	43045-2414	43045-2427	43045-2428	43045-2429	

3.00mm (.118") Micro-Fit 3.0™ Wire-to-Board Header

43045
Dual Row, Vertical, SMT
With Solderable Retention Clip

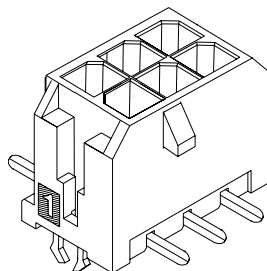

Features and Benefits

- Solderable retention clip provides optimum retention to PCB
- Fully polarized to mating receptacle
- Tape and reel packaging eliminates handling and provides for higher insertion speeds compared to tray packing or hand assembly

Reference Information

Product Specification: PS-43045
Packaging: Tape and reel
UL File No.: E29179
CSA File No.: LR19980
TUV License No.: R72040445
Mates With: 43025
Designed In: Millimeters

Electrical

Voltage: 250V
Current: 5.0A max.
Contact Resistance: 30 milliohms max.
Dielectric Withstanding Voltage: 1500V AC
Insulation Resistance: 1000 Megohms min.

Mechanical

Insertion Force to PCB: 7.5kgf max. (16.5 lb)

Physical

Housing: High temperature LCP, UL 94V-0
Contact: Brass
Plating: Tin or Gold

Circuits	Order No.			Lead-free	Circuits	Order No.			Lead-free
	Tin	15µ" Gold	30µ" Gold			Tin	15µ" Gold	30µ" Gold	
2	43045-0215	43045-0216	43045-0217	Yes	14	43045-1415	43045-1416	43045-1417	Yes
4	43045-0415	43045-0416	43045-0417		16	43045-1615	43045-1616	43045-1617	
6	43045-0615	43045-0616	43045-0617		18	43045-1815	43045-1816	43045-1817	
8	43045-0815	43045-0816	43045-0817		20	43045-2015	43045-2016	43045-2017	
10	43045-1015	43045-1016	43045-1017		22	43045-2215	43045-2216	43045-2217	
12	43045-1215	43045-1216	43045-1217		24	43045-2415	43045-2416	43045-2417	

3.00mm (.118") Pitch Micro-Fit 3.0™ Wire-to-Board Header

43045
Dual Row, Vertical, SMT
With Solderable Fitting Nail

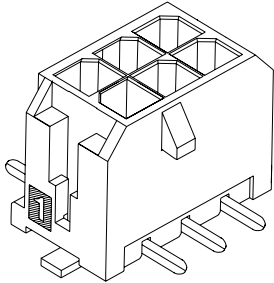

Features and Benefits

- Solder tabs provide retention to PCB
- Fully polarized to mating receptacle
- Tape and reel packaging eliminates handling and provides for higher PCB board placement speeds compared to tray packing or hand assembly

Reference Information

Product Specification: PS-43045
Packaging: Tape and reel
UL File No.: E29179
CSA File No.: LR19980
TUV License No.: R72040445
Mates With: 43025
Designed In: Millimeters

Electrical

Voltage: 250V
Current: 5.0A max.
Contact Resistance: 30 milliohms max.
Dielectric Withstanding Voltage: 1500V AC
Insulation Resistance: 1000 Megohms min.

Physical

Housing: High temperature LCP, UL 94V-0
Contact: Brass
Plating: Tin or Gold

Circuits	Order No.			Lead-free
	Tin	15µm Gold	30µm Gold	
2	43045-0218	43045-0219	43045-0220	Yes
4	43045-0418	43045-0419	43045-0420	
6	43045-0618	43045-0619	43045-0620	
8	43045-0818	43045-0819	43045-0820	
10	43045-1018	43045-1019	43045-1020	
12	43045-1218	43045-1219	43045-1220	

Circuits	Order No.			Lead-free
	Tin	15µm Gold	30µm Gold	
14	43045-1418	43045-1419	43045-1420	Yes
16	43045-1618	43045-1619	43045-1620	
18	43045-1818	43045-1819	43045-1820	
20	43045-2018	43045-2019	43045-2020	
22	43045-2218	43045-2219	43045-2220	
24	43045-2418	43045-2419	43045-2420	

3.00mm (.118") Pitch Micro-Fit 3.0™ Wire-to-Board Header

43045
Dual Row
Right Angle

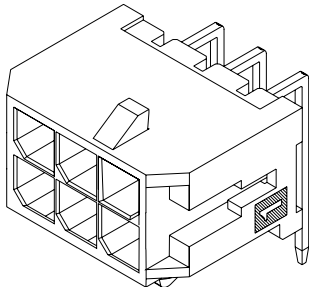

Features and Benefits

- Snap-in peg locks header to PCB for optimum retention
- Fully polarized to mating receptacle
- Surface Mount Compatible

Reference Information

Product Specification: PS-43045
Packaging: Tray
UL File No.: E29179
CSA File No.: LR19980
TUV License No.: R72040445
Mates With: 43025
Designed In: Millimeters

Electrical

Voltage: 250V
Current: 5.0A max.
Contact Resistance: 30 milliohms max.
Dielectric Withstanding Voltage: 1500V AC
Insulation Resistance: 1000 Megohms min.

Mechanical

Insertion Force to PCB: 7.5kgf max. (16.5 lb)

Physical

Housing: High temperature LCP, UL 94V-0
Contact: Brass
Plating: Tin or Gold

Circuits	Order No.			Lead-free
	Tin	15µm Gold	30µm Gold	
2	43045-0200	43045-0201	43045-0202	Yes
4	43045-0400	43045-0401	43045-0402	
6	43045-0600	43045-0601	43045-0602	
8	43045-0800	43045-0801	43045-0802	
10	43045-1000	43045-1001	43045-1002	
12	43045-1200	43045-1201	43045-1202	

Circuits	Order No.			Lead-free
	Tin	15µm Gold	30µm Gold	
14	43045-1400	43045-1401	43045-1402	Yes
16	43045-1600	43045-1601	43045-1602	
18	43045-1800	43045-1801	43045-1802	
20	43045-2000	43045-2001	43045-2002	
22	43045-2200	43045-2201	43045-2202	
24	43045-2400	43045-2401	43045-2402	

3.00mm (.118") Pitch Micro-Fit 3.0™ Wire-to-Board Header

43045
Dual Row, Right Angle, SMT
With Solderable Retention Clip

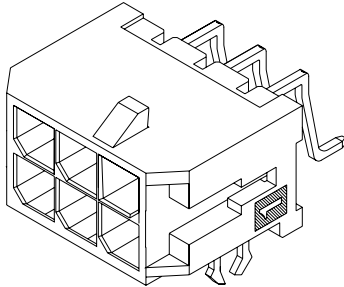

Features and Benefits

- Solderable retention clip provides optimum retention to PCB
- Fully polarized to mating receptacle
- Tape and reel packaging eliminates handling and provides higher insertion speed compared to tray packing or hand assembly

Reference Information

Product Specification: PS-43045
Packaging: Tape and reel
UL File No.: E29179
CSA File No.: LR19980
TUV License No.: R72040445
Mates With: 43025
Designed In: Millimeters

Electrical

Voltage: 250V
Current: 5.0A max.
Contact Resistance: 30 milliohms max.
Dielectric Withstanding Voltage: 1500V AC
Insulation Resistance: 1000 Megohms min.

Mechanical

Insertion Force to PCB: 7.5kgf max. (16.5 lb)

Physical

Housing: High temperature LCP, UL 94V-0
Contact: Brass
Plating: Tin or Gold

Circuits	Order No.			Lead-free
	Tin	15µm Gold	30µm Gold	
2	43045-0206	43045-0207	43045-0208	Yes
4	43045-0406	43045-0407	43045-0408	
6	43045-0606	43045-0607	43045-0608	
8	43045-0806	43045-0807	43045-0808	
10	43045-1006	43045-1007	43045-1008	
12	43045-1206	43045-1207	43045-1208	

Circuits	Order No.			Lead-free
	Tin	15µm Gold	30µm Gold	
14	43045-1406	43045-1407	43045-1408	Yes
16	43045-1606	43045-1607	43045-1608	
18	43045-1806	43045-1807	43045-1808	
20	43045-2006	43045-2007	43045-2008	
22	43045-2206	43045-2207	43045-2208	
24	43045-2406	43045-2407	43045-2408	

3.00mm (.118") Pitch Micro-Fit 3.0™ Wire-to-Board Header

43045
Dual Row, Right Angle, SMT
With Solderable Fitting Nail

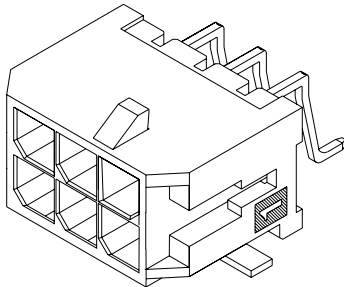

Features and Benefits

- Solder tabs provide retention to PCB
- Fully polarized to mating receptacle
- Tape and reel packaging eliminates handling and provides higher insertion speeds compared to tray packing or hand assembly

Reference Information

Product Specification: PS-43045
Packaging: Tape and reel
UL File No.: E29179
CSA File No.: LR19980
TUV License No.: R72040445
Mates With: 43025
Designed In: Millimeters

Electrical

Voltage: 250V
Current: 5.0A max.
Contact Resistance: 30 milliohms max.
Dielectric Withstanding Voltage: 1500V AC
Insulation Resistance: 1000 Megohms min.

Physical

Housing: High temperature LCP, UL 94V-0
Contact: Brass
Plating: Tin or Gold

Circuits	Order No.			Lead-free
	Tin	15µm Gold	30µm Gold	
2	43045-0209	43045-0210	43045-0211	Yes
4	43045-0409	43045-0410	43045-0411	
6	43045-0609	43045-0610	43045-0611	
8	43045-0809	43045-0810	43045-0811	
10	43045-1009	43045-1010	43045-1011	
12	43045-1209	43045-1210	43045-1211	

Circuits	Order No.			Lead-free
	Tin	15µm Gold	30µm Gold	
14	43045-1409	43045-1410	43045-1411	Yes
16	43045-1609	43045-1610	43045-1611	
18	43045-1809	43045-1810	43045-1811	
20	43045-2009	43045-2010	43045-2011	
22	43045-2209	43045-2210	43045-2211	
24	43045-2409	43045-2410	43045-2411	

3.00mm (.118") Pitch Micro-Fit 3.0™ Test Plug

44242
Dual Row

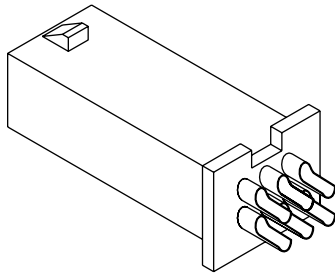

Features and Benefits

- Rated for 10,000 mating cycles
- Minimal expense and downtime for test plug replacement
- Gold-plated, beryllium copper contacts are precision made for long life
- To be used for continuity testing only*
- Micro-Fit dual row sizes available for every application: 4 to 24 circuits**
- Mismatching prevented because plug is fully polarized to mating receptacle

Reference Information

Product Specification: PS-43045
Packaging: Box
Mates With: 43025, 43645 and 44133
Designed In: Inches

Electrical

Current: 2.5A max.
Contact Resistance: 35 milliohms max.

Mechanical

Contact Retention to Housing: 5.0kgf
Durability: 10,000 cycles

Physical

Housing: Black LCP, UL 94V-0
Contact: Heat-treated Beryllium Copper
Plating: Gold over hard Nickel

Circuits	Order No.	Lead-free
4	44242-0001	Yes
6	44242-0002	
8	44242-0003	
10	44242-0004	
12	44242-0005	
14	44242-0006	

Circuits	Order No.	Lead-free
16	44242-0007	Yes
18	44242-0008	
20	44242-0009	
22	44242-0010	
24	44242-0011	

* Important: Micro-Fit test headers cannot be mated or unmated under load. All current must be shut off prior to mating or unmating.

**To test single row receptacles (43645), use test plugs which have twice as many circuits as the receptacles to be tested.

3.00mm (.118") Pitch Micro-Fit 3.0 BMI™ Board-to-Board and Wire-to-Board Receptacle Header

44769
Dual Row, Vertical

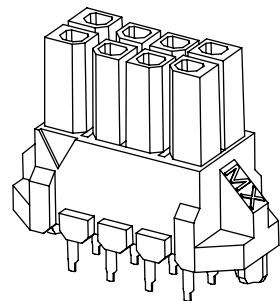

Features and Benefits

- 4 to 24 circuits for design flexibility
- Fully isolated contacts prevent terminal damage
- Fully polarized to prevent mismatching

Reference Information

Product Specification: PS-44300
Packaging: Tray
UL File No.: E29179
CSA File No.: LR19980A
TUV File No.: R72040445
Mates With: 44300, 44428, 44432 and 45280
Designed In: Millimeters

Electrical

Voltage: 250V
Current: 5.0A max.
Contact Resistance: 30 milliohms max.
Dielectric Withstanding Voltage: 1500V AC

Mechanical

Insertion Force to PCB: 7.5kgf max. (16.5 lb)
Durability: 30 cycles

Physical

Housing: Glass-filled nylon, UL 94V-0
Contact: Brass
Plating: Contact Area—Tin or Gold
Solder Tail Area—Tin
Underplating—Nickel
PCB Thickness: 1.57mm (.062")

Circuits	Order No.			Lead-free
	Tin	15" Gold	30" Gold	
4	44769-0401	44769-0402	44769-0403	Yes
6	44769-0601	44769-0602	44769-0603	
8	44769-0801	44769-0802	44769-0803	
10	44769-1001	44769-1002	44769-1003	
12	44769-1201	44769-1202	44769-1203	
14	44769-1401	44769-1402	44769-1403	
16	44769-1601	44769-1602	44769-1603	
18	44769-1801	44769-1802	44769-1803	
20	44769-2001	44769-2002	44769-2003	
22	44769-2201	44769-2202	44769-2203	
24	44769-2401	44769-2402	44769-2403	

3.00mm (.118") Pitch Micro-Fit 3.0 BMI™ Board-to-Board and Wire-to-Board Receptacle Header

44764

Dual Row, Right Angle

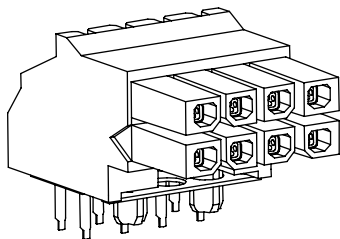

Features and Benefits

- 4 to 24 circuits for design flexibility
- Fully isolated contacts prevent terminal damage
- Fully polarized to prevent mismatching

Reference Information

Product Specification: PS-44300
Packaging: Tray
UL File No.: E29179
CSA File No.: LR19980A
TUV File No.: R72040445
Mates With: 44300, 44428, 44432 and 45280
Designed In: Millimeters

Electrical

Voltage: 250V
Current: 5.0A max.
Contact Resistance: 30 milliohms max.
Dielectric Withstanding Voltage: 1500V AC

Mechanical

Insertion Force to PCB: 7.5kgf max. (16.5 lb)
Durability: 30 cycles

Physical

Housing: Glass-filled nylon, UL 94V-0
Contact: Brass
Plating: Contact Area—Tin or Gold
Solder Tail Area—Tin
Underplating—Nickel
PCB Thickness: 1.57mm (.062")

Circuits	Order No.			Lead-free
	Tin	15 μ " Gold	30 μ " Gold	
4	44764-0401	44764-0402	44764-0403	Yes
6	44764-0601	44764-0602	44764-0603	
8	44764-0801	44764-0802	44764-0803	
10	44764-1001	44764-1002	44764-1003	
12	44764-1201	44764-1202	44764-1203	
14	44764-1401	44764-1402	44764-1403	
16	44764-1601	44764-1602	44764-1603	
18	44764-1801	44764-1802	44764-1803	
20	44764-2001	44764-2002	44764-2003	
22	44764-2201	44764-2202	44764-2203	
24	44764-2401	44764-2402	44764-2403	

3.00mm (.118") Pitch Micro-Fit 3.0 BMI™ Board-to-Board and Wire-to-Board Header

44432

Dual Row, Vertical

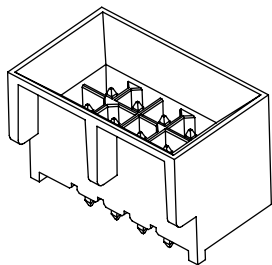

Features and Benefits

- 4 to 24 circuits for design flexibility
- Fully isolated contacts prevent terminal damage
- Fully polarized to prevent mismatching

Reference Information

Product Specification: PS-44300
Packaging: Tray
UL File No.: E29179
CSA File No.: LR19980A
TUV File No.: R72040445
Mates With: 44133, 44764 and 44769
Designed In: Millimeters

Electrical

Voltage: 250V
Current: 5.0A max.
Contact Resistance: 30 milliohms max.
Dielectric Withstanding Voltage: 1500V AC

Mechanical

Insertion Force to PCB: 7.5kgf max. (16.5 lb)
Durability: 30 cycles

Physical

Housing: Glass-filled nylon, UL 94V-0
Contact: Brass
Plating: Contact Area—Tin or Gold
Solder Tail Area—Tin
Underplating—Nickel
PCB Thickness: 1.57mm (.062")

Circuits	Order No.			Lead-free
	Tin	15 μ " Gold	30 μ " Gold	
4	44432-0401	44432-0402	44432-0403	Yes
6	44432-0601	44432-0602	44432-0603	
8	44432-0801	44432-0802	44432-0803	
10	44432-1001	44432-1002	44432-1003	
12	44432-1201	44432-1202	44432-1203	
14	44432-1401	44432-1402	44432-1403	
16	44432-1601	44432-1602	44432-1603	
18	44432-1801	44432-1802	44432-1803	
20	44432-2001	44432-2002	44432-2003	
22	44432-2201	44432-2202	44432-2203	
24	44432-2401	44432-2402	44432-2403	

3.00mm (.118") Pitch Micro-Fit 3.0 BMI™ Board-to-Board and Wire-to-Board Header

44428
Dual Row, Right Angle

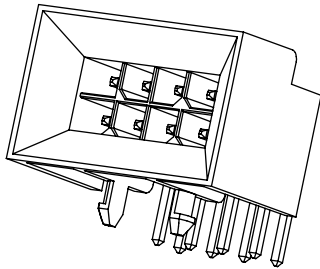

Features and Benefits

- 4 to 24 circuits for design flexibility
- Fully isolated contacts prevent terminal damage
- Fully polarized to prevent mismatching

Reference Information

Product Specification: PS-44300
Packaging: Tray
UL File No.: E29179
CSA File No.: LR19980A
TUV File No.: R72040445
Mates With: 44133, 44764 and 44769
Designed In: Millimeters

Electrical

Voltage: 250V
Current: 5.0A max.
Contact Resistance: 30 milliohms max.
Dielectric Withstanding Voltage: 1500V AC

Mechanical

Insertion Force to PCB: 7.5kgf max. (16.5 lb)
Durability: 30 cycles

Physical

Housing: Glass-filled nylon, UL 94V-0
Contact: Brass
Plating: Contact Area—Tin or Gold
Solder Tail Area—Tin
Underplating—Nickel
PCB Thickness: 1.57mm (.062")

Circuits	Order No.			Lead-free
	Tin	15µ" Gold	30µ" Gold	
4	44428-0401	44428-0402	44428-0403	Yes
6	44428-0601	44428-0602	44428-0603	
8	44428-0801	44428-0802	44428-0803	
10	44428-1001	44428-1002	44428-1003	
12	44428-1201	44428-1202	44428-1203	
14	44428-1401	44428-1402	44428-1403	
16	44428-1601	44428-1602	44428-1603	
18	44428-1801	44428-1802	44428-1803	
20	44428-2001	44428-2002	44428-2003	
22	44428-2201	44428-2202	44428-2203	
24	44428-2401	44428-2402	44428-2403	

3.00mm (.118") Micro-Fit 3.0 BMI™ Panel-to-Panel Receptacle

44133
Dual Row

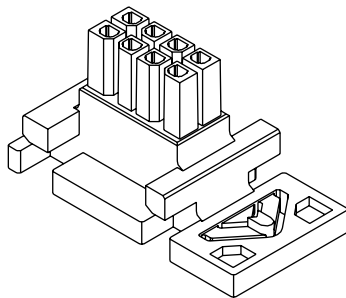

Features and Benefits

- Receptacle floats in panel cutout up to 1.27mm (.050") in any direction
- 4 to 24 circuits for design flexibility
- Use standard Micro-Fit 3.0 terminals to reduce inventory
- Innovative panel mounting design holds connectors firmly in place
- Fully isolated contacts prevent terminal damage
- Fully polarized to completely prevent mismatching

Reference Information

Product Specification: PS-44300
Packaging: Tray
UL File No.: E29179
CSA File No.: LR19980
TUV License No.: R72040445
Mates With: 44300, 44428, 44432 and 45280
Use With: 43030
Designed In: Millimeters

Electrical

Dielectric Withstanding Voltage: 1500V AC
Insulation Resistance: 1000 Megohms min.

Mechanical

Contact Insertion Force: 14.7N (3.30 lb)
Contact Retention to Housing: 24.5N (5.50 lb)

Physical

Housing: Polyester, UL 94V-0

Circuits	Order No.
4	44133-0400
6	44133-0600
8	44133-0800
10	44133-1000
12	44133-1200
14	44133-1400

Circuits	Order No.
16	44133-1600
18	44133-1800
20	44133-2000
22	44133-2200
24	44133-2400

3.00mm (.118") Micro-Fit 3.0 BMI™ Panel-to-Panel Plug

44300
Dual Row

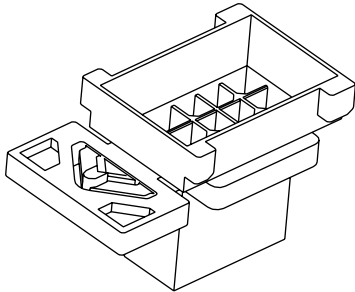

Features and Benefits

- 4 to 24 circuits for design flexibility
- Use standard Micro-Fit terminals to reduce inventory
- Innovative panel mounting design holds connectors firmly in place
- Fully isolated contacts prevent terminal damage
- Fully polarized to completely prevent mismatching

Reference Information

Product Specification: PS-44300
 Packaging: Bag
 UL File No.: E29179
 CSA File No.: LR19980
 TUV License No.: R72040445
 Mates With: 44133, 44764 and 44769
 Use With: 43031
 Designed In: Millimeters

Electrical

Dielectric Withstanding Voltage: 1500V AC
 Insulation Resistance: 1000 Megohms min.

Mechanical

Contact Insertion Force: 14.7N (3.30 lb)
 Contact Retention to Housing: 24.5N (5.50 lb)

Physical

Housing: Polyester, UL 94V-0

Circuits	Order No.
4	44300-0400
6	44300-0600
8	44300-0800
10	44300-1000
12	44300-1200
14	44300-1400

Circuits	Order No.
16	44300-1600
18	44300-1800
20	44300-2000
22	44300-2200
24	44300-2400

3.00mm (.118") Pitch Micro-Fit BMI CPI™ Board-to-Board and Wire-to-Board Header

45280
Dual Row, Vertical

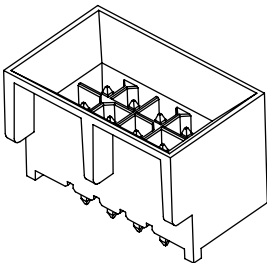

Features and Benefits

- Solderless board connection
- 4 to 24 circuits for design flexibility
- Fully isolated contacts prevent terminal damage
- Fully polarized to prevent mismatching

Reference Information

Product Specification: PS-44300
 Packaging: Tray
 UL File No.: E29179
 CSA File No.: LR19980A
 TUV File No.: R72040445
 Mates With: 44133, 44764 and 44769
 Designed In: Millimeters

Electrical

Voltage: 250V
 Current: 5.0A max.
 Contact Resistance: 30 milliohms max.
 Dielectric Withstanding Voltage: 1500V AC

Mechanical

Insertion Force to PCB: 10.9kgf max. (24 lbf) per terminal
 Retention Force to PCB: 3.6kgf max. (8lbf) per terminal
 Durability: 30 cycles

Physical

Housing: Glass-filled nylon, UL 94V-0
 Contact: Brass
 Plating: Contact Area—Tin or Gold
 Solder Tail Area—Tin or Tin/Lead
 Underplating—Nickel
 PCB Thickness: 2.34mm (.092") min.

Circuits	Order No.			Lead-free
	Tin	15µm Gold	30µm Gold	
4	45280-0401	45280-0452	45280-0453	Yes
6	45280-0601	45280-0652	45280-0653	
8	45280-0801	45280-0852	45280-0853	
10	45280-1001	45280-1052	45280-1053	
12	45280-1201	45280-1252	45280-1253	
14	45280-1401	45280-1452	45280-1453	
16	45280-1601	45280-1652	45280-1653	
18	45280-1801	45280-1852	45280-1853	
20	45280-2001	45280-2052	45280-2053	
22	45280-2201	45280-2252	45280-2253	
24	45280-2401	45280-2452	45280-2453	

Circuits	Order No.		Lead-free
	15µm Gold	30µm Gold	
4	45280-0402	45280-0403	No
6	45280-0602	45280-0603	
8	45280-0802	45280-0803	
10	45280-1002	45280-1003	
12	45280-1202	45280-1203	
14	45280-1402	45280-1403	
16	45280-1602	45280-1603	
18	45280-1802	45280-1803	
20	45280-2002	45280-2003	
22	45280-2202	45280-2203	
24	45280-2402	45280-2403	

3.00mm (.118") Pitch Micro-Fit CPI™ Wire-to-Board Header 44914 Dual Row, Vertical

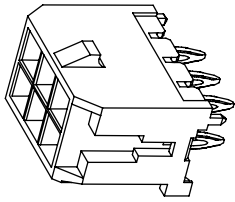

Features and Benefits

- Solderless board connection
- 2 to 24 circuits for design flexibility
- Fully isolated contacts prevent terminal damage
- Fully polarized to prevent mismatching

Reference Information

Product Specification: PS-43045
 Packaging: Tray
 UL File No.: E29179
 CSA File No.: LR19980A
 TUV File No.: R72040445
 Mates With: 43025
 Designed In: Millimeters

Electrical

Voltage: 250V
 Current: 5.0A max.
 Contact Resistance: 30 milliohms max.
 Dielectric Withstanding Voltage: 1500V AC

Mechanical

Insertion Force to PCB: 10.7kgf max. (24 lbf) per terminal
 Retention Force to PCB: 3.6kgf max. (8lbf) per terminal
 Durability: 30 cycles

Physical

Housing: High-temperature LCP, UL 94V-0
 Contact: Brass
 Plating: Contact Area—Tin or Gold
 Solder Tail Area—Tin or Tin/Lead
 Underplating—Nickel
 PCB Thickness: 2.34mm (.092") min.

Circuits	Order No.			Lead-free
	Tin	15µ" Gold	30µ" Gold	
2	44914-0201	44914-5202	44914-5203	Yes
4	44914-0401	44914-5402	44914-5403	
6	44914-0601	44914-5602	44914-5603	
8	44914-0801	44914-5802	44914-5803	
10	44914-1001	44914-6002	44914-6003	
12	44914-1201	44914-6202	44914-6203	
14	44914-1401	44914-6402	44914-6403	
16	44914-1601	44914-6602	44914-6603	
18	44914-1801	44914-6802	44914-6803	
20	44914-2001	44914-7002	44914-7003	
22	44914-2201	44914-7202	44914-7203	
24	44914-2401	44914-7402	44914-7403	

Circuits	Order No.		Lead-free
	15µ" Gold	30µ" Gold	
2	44914-0202	44914-0203	No
4	44914-0402	44914-0403	
6	44914-0602	44914-0603	
8	44914-0802	44914-0803	
10	44914-1002	44914-1003	
12	44914-1202	44914-1203	
14	44914-1402	44914-1403	
16	44914-1602	44914-1603	
18	44914-1802	44914-1803	
20	44914-2002	44914-2003	
22	44914-2202	44914-2203	
24	44914-2402	44914-2403	

**2.54mm (.100") Pitch
MX123™
Sealed Connection System
0.64mm Terminal
33467/33468**

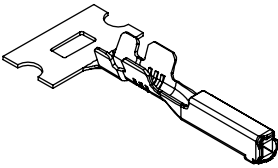

Features and Benefits

- Precious plating ensures stable contact resistance under extreme temperature and vibration conditions

Reference Information

Packaging: Reel
Mates With: 73- and 80-Circuit Receptacle (Series 34566)
56 Receptacle (Series 34576)

Electrical

Voltage: 500V max.
Current: 0.64mm (.025")—11.0A max.
Contact Resistance: 0.64mm (.025")—20 milliohms max.
Dielectric Withstanding Voltage: 1500V AC
Isolation Resistance: 20 Megohms min.

Mechanical

Durability—10 Cycles:
0.64mm (.025")—20 milliohms max.
FCLT (Class 3): 20 milliohms max.
Thermal Shock (Class 3, 100 cycles):
0.64mm (.025")—20 milliohms max.
Mechanical Shock and Vibration Sequence (GMW3191, Electrical):
0.64mm (.025")—20 milliohms max.

Physical

Contact: Copper Alloy
Terminal Plating:
Contact Area: 0.64mm (.025")—Gold
Underplating: 0.64mm (.025")—Nickel

Order No.	Size (mm)	Plating	Wire Size (AWG)	Payoff Direction
33467-0004	0.64	Gold	22	D
33467-0003				B
33467-0006			18 to 20	D
33467-0005				B
33468-0002		Tin	22	D
33468-0001				B
33468-0004			18 to 20	D
33468-0003				B

**2.54mm (.100") Pitch
MX123™
Sealed Connection System
Cavity Plug
34586**

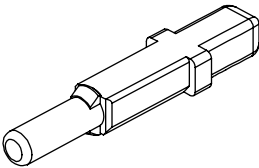

Reference Information

Packaging: Bulk
Use With: 73- and 80-Circuit Receptacle (Series 34566)
56 Circuit Receptacle (Series 34576)

Mechanical

Insertion Force: Less than 40N (9 lb)

Physical

Material: 30% glass-filled SPS/Nylon Blend

Order No.	Assembly Features	Size (mm)
34586-0001	Lock Tab and Forward Stop	0.64mm terminal

2.54mm (.100") Pitch MX123™ Sealed Connection System Lever Receptacle

34566/34576
Mate-Assist

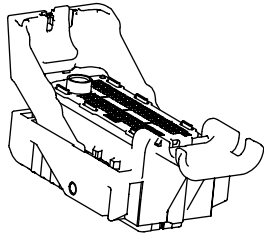

Features and Benefits

- MX123 was originally designed for on-engine, high-vibration applications in under-hood environments
- Receptacle and header housings with unique mechanical polarization options and unique color coding offer the ability to use multiple connectors on one module without the risk of cross-mating incorrect harness connectors
- Wire dress available in 2 options: 0 and 180° orientation which allows for wire-routing design flexibility
- Anti-scooping feature is friendly to “blind-mate” conditions
- Integrated PLR and CPA components reduce assembly complexity
- Lever retention lock on harness connector retains lever in pre-lock position for ease of installation

Reference Information

Packaging: Lever Receptacles: Cell-Pack Partition
Mates With: 73- and 80-Circuit: Headers (Series 31387)
56- Circuit: Header (Series 31386)
Use With: MX64—0.64mm (.025") (Series 33467)

Electrical

Voltage: 500V max.
Current: 2.80mm (.110")—25.0A max.
0.64mm (.025")—11.0A max.
Contact Resistance: 2.80mm (.110")—5 milliohms max.
0.64mm (.025")—20 milliohms max.
Dielectric Withstanding Voltage: 1500V AC
Isolation Resistance: 20 Megohms min.

Mechanical

Mating Force: Less than 75N (16.9 lb)
Unmating Force: Less than 75N (16.9 lb)
Connector Retention (Primary Latch): 110N (24.7 lb) min.
Contact Retention to Housing:
2.80mm (.110")—90N (20.2 lb) min.
0.64mm (.025")—75N (16.9 lb) min.
Contact Insertion Force Into Housing: 30N (6.7 lb) max.
Polarization Feature Effectiveness: 220N (49.5 lb) min.
Durability—10 Cycles:
2.80mm (.110")—5 milliohms max.
0.64mm (.025")—20 milliohms max.
PLR Insertion Force: 75N (16.9 lb) max.
PLR Extraction Force: 120N (27.0 lb) max.
CPA Insertion Force: 60N (13.5 lb) max. (unmated),
22N (5.0 lb) max. (fully mated)
CPA Extraction Force: 22N (5.0 lb) max.
FCLT (Class 3): 20 milliohms max.
Thermal Shock (Class 3, 100 cycles):
2.80mm (.110")—5 milliohms max.
0.64mm (.025")—20 milliohms max.
High-Temperature Exposure (Sealing): 48kPa for 15 seconds
and submersion for 30 minutes and isolation resistance
of 20 Megohms at 500V DC min.
Temperature/Humidity (Sealing): 48kPa for 15 seconds and
submersion for 30 minutes and isolation resistance of
20 Megohms at 500V DC min.
Fluid Resistance (Sealing): submersion for 30 minutes and
isolation resistance of 100 Megohms at 500V DC min.
Mechanical Shock and Vibration Sequence
(GMW3191, Electrical):
2.80mm (.110")—5 milliohms max.
0.64mm (.025")—20 milliohms max.
Ingress Protection (IP-code) Rating: -IP6K7
-IP6K9K

Physical

Housing: 30% glass-filled SPS/Nylon Blend
PLR: 30% Glass Filled SPS/Nylon Blend
Contact: Copper Alloy
Terminal Plating:
Contact Area: 2.80mm (.110")—Tin
0.64mm (.025")—Gold
Underplating: 2.80mm (.110")—Nickel
0.64mm (.025")—Nickel

Order No.	Circuit Size	Key Option	PLR Color
34566-0703	80	G	Blue
34566-0803		H	Gray
34566-0103		A	Black
34566-0203	73	B	Gray
34566-0303		C	Blue
34576-0703		G	
34576-0803	56	H	Gray

2.54mm (.100") Pitch MX123™ Sealed Connection System Wire Dress Cover

34565/34575

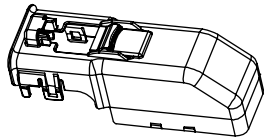

Order No.	Assembly Features	Cover for Circuit Sizes
34565-0003	Lever Retention Lock	73 and 80
34575-0003		56

Features and Benefits

- Wire dress available in 2 options: 0 and 180° orientation which allows for wire-routing design flexibility

Reference Information

Packaging: Bulk
Use With: 73- and 80-Circuit Receptacle (Series 34566)
56 Circuit Receptacle (Series 34576)

Mechanical

Engage Force: Less than 75N (16.9 lb)
Disengage Force: Less than 110N (16.9 lb)

Physical

Material: 30% glass-filled SPS/Nylon Blend

2.54mm (.100") Pitch MX123™ Sealed Connection System Header

31386/31387

Vertical, Top-Load, Solder-tail

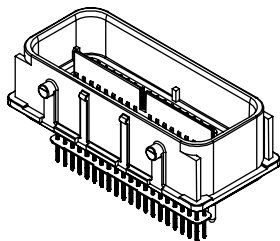

Features and Benefits

- MX123 was originally designed for on-engine, high-vibration applications in under-hood environments
- Receptacle and header housings with unique mechanical polarization options and unique color coding offer the ability to use multiple connectors on one module without the risk of cross-mating incorrect harness connectors
- Anti-scooping feature is friendly to "blind-mate" conditions
- PCB tail customization: available with solder-tail or compliant-pin technology allows for PCB design flexibility
- Header placement flexibility allows top or bottom header loading to streamline module manufacturing process
- Precious plating ensures stable contact resistance under extreme temperature and vibration conditions

Reference Information

Vertical Headers: Tray
Mates With: 73- and 80-Circuit Receptacle (Series 34566)
56 Receptacle (Series 34576)
Use With: MX64—0.64mm (.025") (Series 33467)

Electrical

Voltage: 500V max.
Current: 2.80mm (.110")—25.0A max.
0.64mm (.025")—11.0A max.
Contact Resistance: 2.80mm (.110")—5 milliohms max.
0.64mm (.025")—20 milliohms max.
Dielectric Withstanding Voltage: 1500V AC
Isolation Resistance: 20 Megohms min.

Mechanical

Mating Force: Less than 75N (16.9 lb)
Unmating Force: Less than 75N (16.9 lb)
Connector Retention (Primary Latch): 110N (24.7 lb) min.
Polarization Feature Effectiveness: 220N (49.5 lb) min.
Durability—10 Cycles:
2.80mm (.110")—5 milliohms max.
0.64mm (.025")—20 milliohms max.
FCLT (Class 3): 20 milliohms max.
Thermal Shock (Class 3, 100 cycles):
2.80mm (.110")—5 milliohms max.
0.64mm (.025")—20 milliohms max.
High-Temperature Exposure (Sealing): 48kPa for 15 seconds and submersion for 30 minutes and isolation resistance of 20 Megohms at 500V DC min.
Temperature/Humidity (Sealing): 48kPa for 15 seconds and submersion for 30 minutes and isolation resistance of 20 Megohms at 500V DC min.
Fluid Resistance (Sealing): submersion for 30 minutes and isolation resistance of 100 Megohms at 500V DC min.
Mechanical Shock and Vibration Sequence (GMW3191, Electrical): 2.80mm (.110")—5 milliohms max.
0.64mm (.025")—20 milliohms max.

Physical

Housing: 30% glass-filled PBT
Contact: Copper Alloy
Terminal Plating:
Contact Area: 2.80mm (.110")—Tin
0.64mm (.025")—Gold
Underplating: 2.80mm (.110")—Nickel
0.64mm (.025")—Nickel

Order No.	Plating	Circuit Size	Key Option	Colors
31387-4001	Select Gold	80	G	Blue
31387-4009			H	Gray
31387-2014			A	Black
31387-2002			B	Gray
31387-2003		C		
31386-2001		G	Blue	
31386-2002		H	Gray	
		56		

2.54mm (.100") Pitch MX64™ Sealed Connectors

31403 Single Row Female

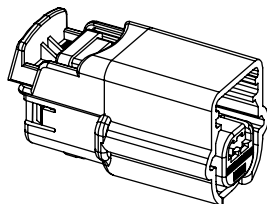

Features and Benefits

- Meets all USCAR footprints and testing requirements
- Matte seal design
- Available with or without CPA
- Polarization options available

Reference Information

Packaging: Bag
Mates With: Direct connect only
Designed In: Millimeters

Electrical

Voltage: 250V
Current: 11.0A max.
Contact Resistance: 20 milliohms max.
Dielectric Withstanding Voltage: 500V DC
Insulation Resistance: 20 Megohms min.

Mechanical

Contact Insertion Force: 30N max.
Contact Retention to Housing: 90N min.
Mating Force: Less than 75N
Unmating Force: Less than 75N

Physical

Housing: Glass-filled PBT
Contact: Tin or Gold
Wire Gauge: 18 to 22 AWG

Order No.		Rows/Circuits	Polarization	Color
Without CPA	With CPA			
31403-2100	31403-2110	1x2	A	Black
31403-2200	31403-2210		B	Gray
31403-2300	31403-2310		C	Brown
31403-2400	31403-2410		D	Green
31403-2500	31403-2510		B	Black
31403-2600	31403-2610		C	
31403-2700	31403-2710		D	
31403-3100	31403-3110		A	
31403-3200	31403-3210	1x3	B	Gray
31403-3300	31403-3310		C	Brown
31403-3400	31403-3410		D	Green
31403-3500	31403-3510		B	Black
31403-3600	31403-3610		C	
31403-3700	31403-3710		D	
31403-6100	31403-6110		A	
31403-6200	31403-6210		1x6	B
31403-6300	31403-6310	C		Brown
31403-6400	31403-6410	D		Green
31403-6500	31403-6510	B		Black
31403-6600	31403-6610	C		
31403-6700	31403-6710	D		

CMC Hybrid Connectors Standard and Power Versions

The CMC connector family from Molex is a sealed, high-density connection system developed for the transportation industry. It is a cost-effective, modular, hybrid system that fits with various headers.

Standard version CMC hybrid connectors hold two different terminal sizes, 0.635mm (.025") and 1.5mm (.059"). Power version CMC hybrid connectors hold three different terminal sizes, 0.635mm (.025"), 1.50mm (.059") and 2.80mm (.110"). Both connector versions run at operating temperatures between -40 and +125°C.

Market and Applications

CMC can be used in the following markets: cars, trucks, buses, agricultural equipment, motorcycle or marine.

This wire-to-board application can run on Powertrain applications such as Engine Control Units, Gear Boxes and Suspension Controllers but also on Body Electronics like Junction Box, Lightning Control System or Electrical Doors.

Features

- The CMC modular system offers various color codings associated with mechanical keying for easy mating with the header.
- With an audible click, the integrated locking lever locks the connector to the header.
- A wire cap guides the wires away from the connector either to the right or to the left.
- Robust CP terminals are specially designed to perform in high-conductivity applications and in harsh environments.

Sealing

High performing matte seal technology is used for CP 0.635mm (.025") and CP 1.50mm (.059") terminals. Single wire-seal technology is used for CP 2.8mm (.110") terminals to secure reliable sealing for 2.8mm (.110") CP terminals.

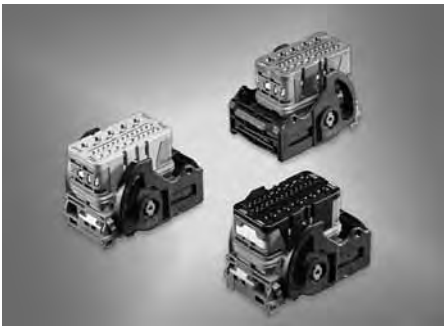
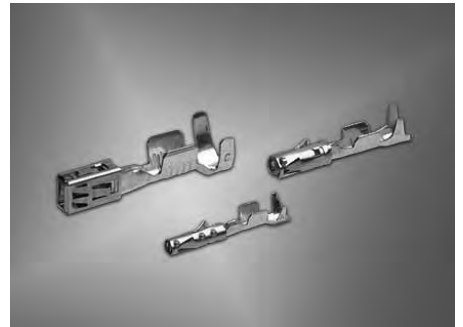

CMC Product Family Part Number Overview

Circuits	Order No.			Description	Color	Sealing	Mates With	Terminal Loading	
	Left Wire Output	Right Wire Output	Wire Cap						
24	64319-2211			CMC Receptacle	black	mat	N/A	18 x CP 0.6 terminal 6 x CP 1.5 terminal	
	64319-2218				grey				
		64319-4211			black				
		64319-4218			grey				
			64319-1201	For CMC Receptacle	N/A		N/A		
28	64318-1011	64318-3011		Power CMC Receptacle	black	mat	Contact Molex	18 x CP 0.6 terminal 5 x CP 1.5 terminal 5 x CP 2.8 terminal	
	64318-1018	64318-3018			grey				
	64318-1019	64318-3019			brown				
			64320-1301		For CMC Receptacle				N/A
32	64319-1211	64319-3211		CMC Receptacle	black	mat	Contact Molex	24 x CP 0.6 terminal 8 x CP 1.5 terminal	
	64319-1216	64319-3216			blue				
	64319-1218	64319-3218			grey				
	64319-1219	64319-3219			brown				
			64319-1201		For CMC Receptacle				N/A
						80 circuit CMC header 502225-0801	N/A		
36	64320-2311			CMC Receptacle	black	mat	48 circuit header with 36 circuit loaded 36638-0006/36638-0008	30 x CP 0.6 terminal 6 x CP 1.5 terminal	
	64320-2319				brown				
		64320-4311			black				
		64320-4319			brown				
			64320-1301		For CMC Receptacle				N/A
						48 circuit header with 36 circuit loaded 36638-0007/36638-0009	N/A		
48	64320-1311			CMC Receptacle	black	mat	48 circuit CMC header/98 circuit CMC header 36638-0001 up to 36638-0012 48 circuit CMC header 500762-0481	40 x CP 0.6 terminal 8 x CP 1.5 terminal	
	64320-1315				green				
	64320-1318				grey				
					brown				
		64320-3311			black				
		64320-3315			green				
		64320-3318			grey				
		64320-3319			brown				
			64320-1301		For CMC Receptacle				N/A
						48 circuit CMC header/98 circuit CMC header 36638-0001 up to 36638-0012 48 circuit CMC header 500762-0481	N/A		
						48 circuit CMC header/98 circuit CMC header 36638-0001 up to 36638-0012	N/A		
53	64321-1011	64321-2011		Power CMC Receptacle	black	mat	53 circuit CMC header 98997-1002	40 x CP 0.6 terminal 8 x CP 1.5 terminal 5 x CP 2.8 terminal	
	64321-1018	64321-2018			grey				
	64321-1019	64321-2019			brown				
			64321-1101		For CMC Receptacle				N/A
						N/A	N/A		

For more details please refer to www.molex.com

CMC Product Family Part Number Overview

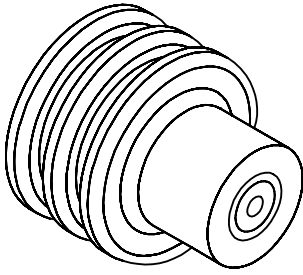

CMC CP Terminal

Order No.	Pitch	Plating	Wire Size	Mates With
64322-1019	0.635mm (.025")	Tin	0.35mm ²	32 circuit CMC Receptacle 48 circuit CMC Receptacle 28 circuit CMC Receptacle 53 circuit CMC Receptacle
64322-1029			0.75mm ²	
64322-1039			0.5mm ²	
64322-1219		Gold 1.27µm	0.75mm ²	
64322-1229			0.35mm ²	
64322-1239			0.5 mm ²	
64322-1339			0.75mm ²	
64322-1349			0.35mm ²	
64322-1359			0.5 mm ²	
64323-1029			1.50mm (.059")	
64323-1039	Gold 1.27µm	>1 to 2mm ²		
64323-1219		>1 to 2mm ²		
64323-1319	2.80mm (.110")	Tin	0.5 to 1mm ²	28 circuit CMC Receptacle 53 circuit CMC Receptacle
64324-1019			>3 to 5mm ²	
64324-1029			>2 to 3mm ²	
64324-1039			>1 to 2mm ²	
64324-1049			0.5 to 1mm ²	
64324-1119		Gold 1.27µm	>3 to 5mm ²	
64324-1129			>2 to 3mm ²	
64324-1139			>1 to 2mm ²	
64324-1149			>1 to 2mm ²	
			0.5 to 1mm ²	

For more details please refer to www.molex.com

CMC Blind Plugs

Order No.	Wire Size	Mates With
64325-1010	0.635mm (.025")	32 circuit CMC Receptacle
64325-1023	1.50mm (.059")	48 circuit CMC Receptacle
64325-1091	2.80mm (.110")	28 circuit CMC Receptacle 53 circuit CMC Receptacle

CMC Single Wire Seals

Order No.	Color	Cable Size	Mates With
64325-1162	Red	1.29 to 2.06mm	CMC CP 2.80 (.110") terminal
64325-1175	Green	2.03 to 2.8mm	
64325-1188	Grey	2.8 to 3.5mm	
64325-1196	Blue	3.5 to 4.21mm	

2.54mm (.100")/ 3.50mm (.138")/ 6.75mm (.266") Pitch CMC Wire-to-Board Power Hybrid Connector Receptacle, Plug and Wire Cap

64318
28 Circuit
Left and Right Wire Output

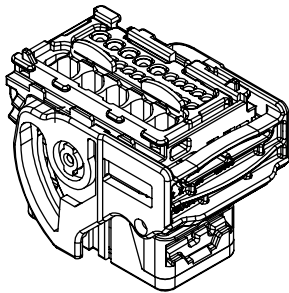

Features and Benefits

- CMC is a sealed, standard and modular connecting system
- Available in several circuit sizes
- Sealed by using high performing matte seal technology
- High density connector
- Hybrid system carrying low, medium and high current
- Used with CMC CP Terminals
- Using CMC CP 2.80 mm terminals for power connecting applications

Reference Information

Product Specification: PS-64318-001

Mates With: 28 circuit CMC header coming soon, please contact Molex for details

Use With:

- Terminal: 64322 CMC CP 0.635mm (.025")
- 64323 CMC CP 1.50mm (.059")
- 64324 CMC CP 2.80mm (.110")

- Plug: 64325-1010 Plug 0.635mm (.025") cavity
- 64325-1023 Plug 1.50mm (.059") cavity
- 64325-1091 Plug 2.80mm (.110") cavity

Wire Cap: 64320-1301 CMC Wire Cap for 48 circuit and 28 circuit CMC Receptacle

Designed In: Millimeters

Electrical

Voltage: 250V AC

Current: *

- 2.5A for CMC CP 0.635mm (.025") terminal (0.75mm² wire)
- 12.0A for CMC CP 1.50mm (.059") terminal (2.0mm² wire)
- 21.0A for CMC CP 2.80mm (.110") terminals (5.0mm²)

Contact Resistance:

- CMC CP 0.635mm (.025")—8 milliohms max.
- CMC CP 1.50mm (.059")—4 milliohms max.
- CMC CP 2.80mm (.110")—3 milliohms max.

Dielectric Withstanding Voltage: 1000V AC for 1 minute

Insulation Resistance: 100 Megohms min.

Mechanical

Contact Insertion Force:

- CMC CP 0.635mm (.025")—12.00N max.
- CMC CP 1.50mm (.059")—20.00N max.
- CMC CP 2.80mm (.110")—25.00N max.

Contact Retention to Housing:

- CMC CP 0.635mm (.025")—60.00N min.
- CMC CP 1.50mm (.059")—100.00N min.
- CMC CP 2.80mm (.110")—100.00N min.

Wire Pull-Out Force: 100.00N min.

Mating Force: 70.00N max.

Unmating Force: 70.00N max.

Durability: 20 mating cycles

Physical

Housing: Glass-filled PBT

* Current tested on a fully loaded connector, current for temperature increase of 40°C

CMC Power Receptacle				
Circuits	Order No.	Coding	Wire output	Lead-Free
28	64318-1011	Black	Left	Yes
	64318-1018	Grey		
	64318-1019	Brown		
	64318-3011	Black	Right	
	64318-3018	Grey		
	64318-3019	Brown		

CMC Wire Cap			
Circuits	Order No.	Housing Color	Lead-Free
For 28 circuit (same wire cap as for 48 circuit CMC Receptacle)	64320-1301	Black	Yes

CMC Plug			
Circuits	Order No.	Housing Color	Lead-Free
0.635mm (.025")	64325-1010	White	Yes
1.50mm (.059")	64325-1023	Orange	
2.80mm (.110")	64325-1091	Black	

2.54mm (.100")/ 3.70mm (.146") Pitch CMC Wire-to-Board Hybrid Connector Receptacle, Plug and Wire Cap

64319
32 Circuit
Left and Right Wire Output

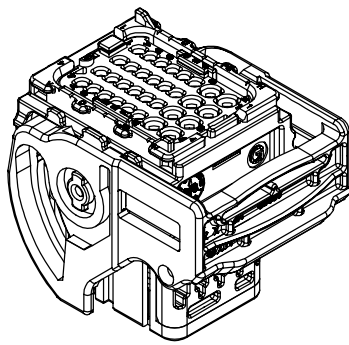

Features and Benefits

- CMC is a sealed, standard and modular connecting system
- Available in several circuit sizes
- Sealed by using high performing matte seal technology
- High density connector
- Hybrid system carrying low and medium current
- Used with CMC CP Terminals

Reference Information

Product Specification: PS-64319-001
 Mates With:
 Single 32 circuit CMC header—please contact Molex
 80 circuit CMC header 502225-0801 (32 + 48 circuit)
 Use With:
 Terminal: 64322 CMC CP 0.635mm (.025")
 64323 CMC CP 1.50mm (.059")
 Plug: 64325-1010 Plug 0.635mm (.025") cavity
 64325-1023 Plug 1.50mm (.059") cavity
 Wire Cap: 64319-1201 CMC Wire Cap for 32 circuit
 CMC Receptacle
 Header: 80 circuit CMC header 502225-0801 (32 + 48 circuit)
 Designed In: Millimeters

Electrical

Voltage: 250V AC
 Current: *
 6.0A for CMC CP 0.635mm (.025") terminal (0.75mm² wire)
 12.0A for CMC CP 1.50mm (.059") terminal (2.0mm² wire)
 Contact Resistance:
 CMC CP 0.635mm (.025")—8 milliohms max.
 CMC CP 1.50mm (.059")—4 milliohms max.
 Dielectric Withstanding Voltage: 1000V AC for 1 minute
 Insulation Resistance: 100 Megohms min.

Mechanical

Contact Insertion Force:
 CMC CP 0.635mm (.025")—12.00N max.
 CMC CP 1.50mm (.059")—20.00N max.
 Contact Retention to Housing:
 CMC CP 0.635mm (.025")—60.00N min.
 CMC CP 1.50mm (.059")—100.00N min.
 Wire Pull-Out Force: 100.00N min.
 Mating Force: 70.00N max.
 Unmating Force: 70.00N max.
 Durability: 20 mating cycles

Physical

Housing: Glass-filled PBT

* Current tested on a 5 terminals loaded connector, current for temperature increase of 40°C

CMC Receptacle					
Circuits	Order No.	Coding	Wire Output	Option	Lead-Free
32	64319-1211	Black	Left		Yes
	64319-1216	Blue			
	64319-1218	Grey			
	64319-1219	Brown			
24	64319-2211	Black		Row 1 closed	
	64319-2218	Grey		Row 4 closed	
32	64319-3211	Black	Right		
	64319-3216	Blue			
	64319-3218	Grey			
	64319-3219	Brown			
24	64319-4211	Black		Row 1 closed	
	64319-4218	Grey		Row 4 closed	

CMC Wire Cap			
Circuits	Order No.	Housing Color	Lead-Free
For 32 circuit	64319-1201	Black	Yes

CMC Plug			
Circuits	Order No.	Housing Color	Lead-Free
0.635mm (.025")	64325-1010	White	Yes
1.50mm (.059")	64325-1023	Orange	



2.54mm (.100")/ 3.70mm (.146") Pitch CMC Wire-to-Board Hybrid Connector Receptacle, Plug and Wire Cap

64320
48 Circuit
Left and Right Wire Output

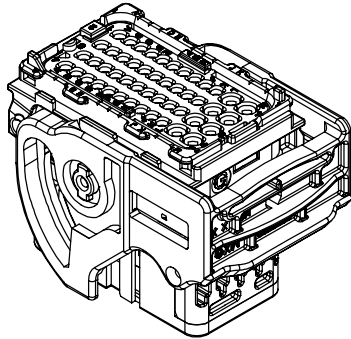

Features and Benefits

- CMC is a sealed, standard and modular connecting system
- Several circuit sizes available
- Sealed by using high performing matte seal technology
- High density connector
- Hybrid system carrying low and medium current
- Used with CMC CP Terminals

Reference Information

Product Specification: PS-64319-001

Mates With:

48 circuit CMC header 500762-0481 and 36638 series
and 80 circuit CMC header 502225-0801 (32 + 48 circuit)

Use With:

Terminal: 64322 CMC CP 0.635mm (.025")

64323 CMC CP 1.50mm (.059")

Plug: 64325-1010 Plug 0.635mm (.025") cavity

64325-1023 Plug 1.50mm (.059") cavity

Wire Cap: 64320-1301 CMC Wire Cap for 48 circuit and
28 circuit CMC Receptacle

Header: 500762-0481 48 circuit CMC header

36638 48 circuit CMC header

502225-0801 80 circuit CMC header (32 + 48
circuit)

Designed In: Millimeters

Electrical

Voltage: 250 V AC

Current: *

6.0A for CMC CP 0.635mm (.025") terminal (0.75mm² wire)

12.0A for CMC CP 1.50mm (.059") terminal (2.0mm² wire)

Contact Resistance:

CMC CP 0.635mm (.025")—8 milliohms max.

CMC CP 1.50mm (.059")—4 milliohms max.

Dielectric Withstanding Voltage: 1000V AC for 1 minute

Insulation Resistance: 100 Megohms min.

Mechanical

Contact Insertion Force:

CMC CP 0.635mm (.025")—12.00N max.

CMC CP 1.50mm (.059")—20.00N max.

Contact Retention to Housing:

CMC CP 0.635mm (.025")—60.00N min.

CMC CP 1.50mm (.059")—100.00N min.

Wire Pull-Out Force: 100.00N min.

Mating Force: 70.00N max.

Unmating Force: 70.00N max.

Durability: 20 mating cycles

Physical

Housing: Glass-filled PBT

* Current tested on a 5 terminals loaded connector, current for temperature increase of 40° C

CMC Receptacle					
Circuits	Order No.	Coding	Wire Output	Option	Lead-Free
48	64320-1311	Black	Left		Yes
	64320-1315	Green			
	64320-1318	Grey			
	64320-1319	Brown			
36	64320-2311	Black		Row 1 closed	
	64320-2319	Brown		Row 1 closed	
48	64320-3311	Black	Right		
	64320-3315	Green			
	64320-3318	Grey			
	64320-3319	Brown			
36	64320-4311	Black		Row 1 closed	
	64320-4319	Brown		Row 1 closed	

CMC Wire Cap			
Circuits	Order No.	Housing Color	Lead-Free
For 48 circuit	64320-1301	Black	Yes

CMC Plug			
Circuits	Order No.	Housing Color	Lead-Free
0.635mm (.025")	64325-1010	White	Yes
1.50mm (.059")	64325-1023	Orange	

2.54mm (.100")/ 3.50mm (.138")/ 7.00mm (.276") Pitch CMC Wire-to-Board Power Hybrid Connector Receptacle, Plug and Wire Cap

64321
53 Circuit
Left and Right Wire Output

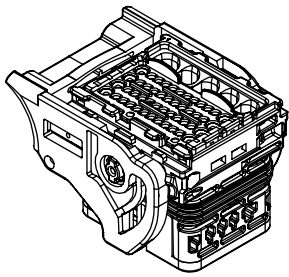

Features and Benefits

- CMC is a sealed, standard and modular connecting system
- Available in several circuit sizes
- Sealed by using high performing matte seal technology
- High density connector
- Hybrid system carrying low, medium and high current
- Used with CMC CP Terminals
- Using CMC CP 2.80mm terminals for power connecting applications

Reference Information

Product Specification: PS-64321-001
Mates With: 53 circuit CMC header 98997-1002,
please contact Molex for details
Use With:
Terminal: 64322 CMC CP 0.635mm (.025")
64323 CMC CP 1.50mm (.059")
64324 CMC CP 2.80mm (.110")
Plug: 64325-1010 Plug 0.635mm (.025") cavity
64325-1023 Plug 1.50mm (.059") cavity
64325-1091 Plug 2.80mm (.110") cavity
Wire Cap: 64321-1101 CMC Wire Cap for 53 circuit
CMC Receptacle
Designed In: Millimeters

Electrical

Voltage: 250V AC
Current: *
2.5A for CMC CP 0.635mm (.025") terminal (0.75mm² wire)
12.0A for CMC CP 1.50mm (.059") terminal (2.0mm² wire)
21.0A for CMC CP 2.80mm (.110") terminals (5.0mm²)
Contact Resistance:
CMC CP 0.635mm (.025")—8 milliohms max.
CMC CP 1.50mm (.059")—4 milliohms max.
CMC CP 2.80mm (.110")—3 milliohms max.
Dielectric Withstanding Voltage: 1000V AC for 1 minute
Insulation Resistance: 100 Megohms min.

Mechanical

Contact Insertion Force:
CMC CP 0.635mm (.025")—12.00N max.
CMC CP 1.50mm (.059")—20.00N max.
CMC CP 2.80mm (.110")—25.00N max.
Contact Retention to Housing:
CMC CP 0.635mm (.025")—60.00N min.
CMC CP 1.50mm (.059")—100.00N min.
CMC CP 2.80mm (.110")—100.00N min.
Wire Pull-Out Force: 100.00N min.
Mating Force: 80.00N max.
Unmating Force: 80.00N max.
Durability: 20 mating cycles

Physical

Housing: Glass-filled PBT

* Current tested on a fully loaded connector, current for temperature increase of 40°C

CMC Power Receptacle				
Circuits	Order No.	Coding	Wire Output	Lead-Free
53	64321-1011	Black	Left	Yes
53	64321-1018	Grey	Left	
53	64321-1019	Brown	Left	
53	64321-2011	Black	Right	
53	64321-2018	Grey	Right	
53	64320-2019	Brown	Right	

CMC Wire Cap			
Circuits	Order No.	Housing Color	Lead-Free
For 53 circuit	64321-1101	Black	Yes

CMC Plug			
Circuits	Order No.	Housing Color	Lead-Free
0.635mm (.025")	64325-1010	White	Yes
1.50mm (.059")	64325-1023	Orange	
2.80mm (.110")	64325-1091	Black	

2.54mm (.100")/ 3.50mm (.138") Pitch Wire-to-Board CMC Hybrid Crimp Housing

98944
32 Circuits

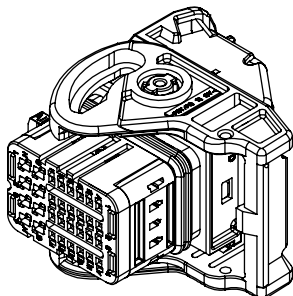

Features and Benefits

- Secondary locking
- Gel grommet seal to facilitate harness assembly (no cavity plug necessary for unplugged cavities)
- Two wire sizes: hybrid 0.635 and 1.50mm (.025 and .060") connector

Reference Information

Packaging: Tray
 Mates With: Various other CMC headers
 Use With: 98658, 98915-10x9 terminals
 and 98649-1003 (wire cap)
 Designed In: Millimeters

Electrical

Voltage: 14V
 Current:
 0.635mm (.025") terminal—6.0A max.
 1.50mm (.060") terminal—11.0A max.
 Contact Resistance:
 0.635mm (.025") terminal—8 milliohms max.
 1.50mm (.060") terminal—4 milliohms max.
 Dielectric Withstanding Voltage: 1000V AC min.
 Insulation Resistance: 100 Megohms min.

Mechanical

Contact Insertion Force:
 0.635mm (.025") terminal—10.00N (2.25 lb)
 1.50mm (.060") terminal—15.00N (3.37 lb)
 Contact Retention to Housing:
 0.635mm (.025") terminal—60.00N (13.49 lb)
 1.50mm (.060") terminal—100.00N (22.48 lb)
 Wire Pull-Out Force: 100.00N (22.48 lb)
 Mating Force: 80.00N (17.98 lb) max.
 Unmating Force: 80.00N (17.98 lb) max.
 Durability: 20 mating cycles

Physical

Housing: Glass-filled PBT Polyester
 Sealing Performance: IP67

Circuits	Order No.		Color
	Assembled Right Wire Output	Assembled Left Wire Output	
32	98944-2001	98944-3001	Black
	98944-2002	98944-3002	Gray
	98944-2003	98944-3003	Brown
	98944-2004	98944-3004	Green
	98944-2005	98944-3005	Blue

2.54mm (.100")/ 3.50mm (.138") Pitch CMC Wire Cap

98649

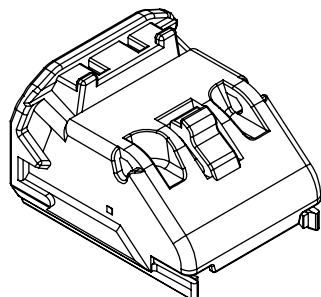

Features and Benefits

- Fixture for strain relief
- Enable right angle wire output in two directions

Reference Information

Packaging: Box
 Use With: 98944-200X or 98944-300X
 Designed In: Millimeters

Physical

Material: Black PA6—Polyamide

Circuits	Order No.
32	98649-1003

2.54mm (.100")/ 3.50mm (.138") Pitch Wire-to-Board CMC Hybrid Crimp Housing

98950
48 Circuits

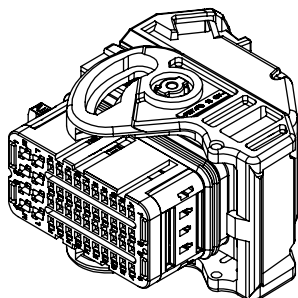

Features and Benefits

- Secondary locking
- Gel grommet seal to facilitate harness assembly (no cavity plug necessary for unplugged cavities)
- Two wire sizes: hybrid 0.635 (.025 and .060") and 1.50mm connector

Reference Information

Packaging: Tray
Mates With: Various other CMC headers
Use With: 98658, 98915-10x9 terminals
and 98649-1003 (wire cap)
Designed In: Millimeters

Electrical

Voltage: 14V
Current: 0.635mm (.025") terminal—6A max.
1.50mm (.060") terminal—11A max.
Contact Resistance:
0.635mm (.025") terminal—8 milliohms max.
1.50mm (.060") terminal—4 milliohms max.
Dielectric Withstanding Voltage: 1000V AC min.
Insulation Resistance: 100 Megohms min.

Mechanical

Contact Insertion Force:
0.635mm (.025") terminal—10.00N (2.25 lb)
1.50mm (.060") terminal—15.00N (3.37 lb)
Contact Retention to Housing:
0.635mm (.025") terminal: 60.00N (13.49 lb)
1.50mm (.060") terminal: 100.00N (22.48 lb)
Wire Pull-Out Force: 100.00N (22.48 lb)
Mating Force: 80.00N (17.98 lb) max.
Unmating Force: 80.00N (17.98 lb) max.
Durability: 20 mating cycles

Physical

Housing: Glass-filled PBT Polyester
Sealing Performance: IP67

Circuits	Order No.		Color
	Assembled Right Wire Output	Assembled Left Wire Output	
48	98950-2001	98950-3001	Black
	98950-2002	98950-3002	Gray
	98950-2003	98950-3003	Brown
	98950-2004	98950-3004	Green
	98950-2005	98950-3005	Blue

2.54mm (.100")/ 3.50mm (.138") Pitch CMC Wire Cap

98655

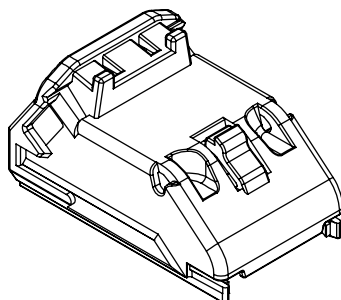

Features and Benefits

- Fixture for strain relief
- Enable right angle wire output in two directions

Reference Information

Packaging: Box
Use With: 98950-200X or 98950-300X
Designed In: Millimeters

Physical

Material: Black PA6—Polyamide

Circuits	Order No.
48	98655-1003

**0.635mm (.025")/
1.50mm (.059")/
2.80mm (.110") Terminal
Cavity
CMC
Hybrid Connector
Blind Plug**

64325

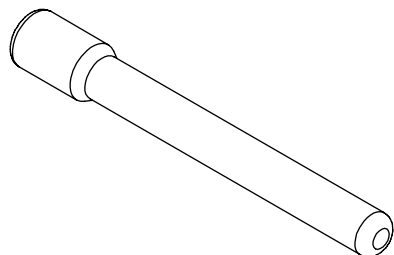

Features and Benefits

- CMC is a sealed, standard and modular connecting system
- Several circuit sizes available
- Sealed by using high performing matte seal technology
- CMC CP blind plugs for unused circuits
- CMC CP blind plugs secure sealing system when flexibility is required for unused cavities with standard backplate

Reference Information

Product Specification:

Please refer to Product Specification of the relevant CMC connector

Mates With:

CMC Plug 0.635mm (.025") and CMC Plug 1.50mm (.059")—CMC connector series 64318, 64319, 64320, and 64321

CMC Plug 2.80mm (.110")—CMC connector series 64318 and 64321

Use With: See under Mates With

Designed In: Millimeters

Physical

CMC CP Plug 0.635mm (.025"): White Polyamid

CMC CP Plug 1.50mm (.059"): Orange Polyamid

CMC CP Plug 2.80mm (.110"): Black Rubber

For CMC CP terminal cavity	Order No.	Color	Material
0.635mm (.025")	64325-1010	White	Polyamid
1.50mm (.059")	64325-1023	Orange	Polyamid
2.80mm (.110")	64325-1091	Black	Rubber

0.635mm (.025") Width CMC CP Female Crimp Terminal

64322

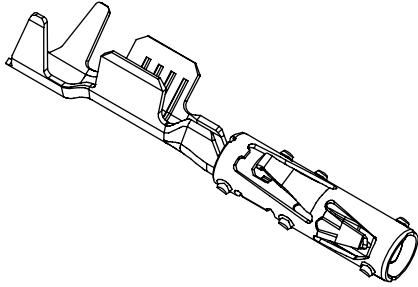

Features and Benefits

- Two piece terminal design
- Tang locking system
- Robust design with fully protected beam
- Various wire size compatibility
- Available in tin and gold plating

Reference Information

Product Specification: Please refer to Product Specification of the relevant CMC connector

Mates With: CMC connector series 64318, 64319, 64320 and 64321

Designed In: Millimeters

Electrical

Voltage: 250V AC

Current: *

6.0A for CMC CP 0.635mm (.025") terminal (0.75mm² wire)

Contact Resistance: CMC CP 0.635mm (.025") 8 milliohms max.

Dielectric Withstanding Voltage: 1000V AC for 1 min.

Insulation Resistance: 100 Megohms min.

Mechanical

Contact Insertion Force into Housing (Sealed Connector):

CMC CP 0.635mm (.025")—12.00N min.

Wire Pull-Out Force: 100.00N min. for wire size of 0.50mm²

Mating/Unmating Force:

Please refer to Product Specification of the relevant

CMC connector the terminal is used with

Durability: 20 mating cycles

Physical

Contact: Phosphor Bronze

Plating: Tin and Gold

Insulation Diameter: See table

* Current tested on a 5 terminals loaded connector, current for temperature increase of 40°C

Order No.	Wire Size (mm ²)	Wire Insulation Diameter (mm)	Wire Size (AWG)	Plating	Lead-Free
64322-1019	0.35	1.25 to 1.40	22, 24	Tin	Yes
64322-1029	0.75	1.60 to 1.90		Tin	
64322-1039	0.50	1.40 to 1.70		Tin	
64322-1219	0.75	1.60 to 1.90		1.27µm Gold	
64322-1229	0.35	1.25 to 1.40	22, 24	1.27µm Gold	
64322-1239	0.50	1.40 to 1.70		1.27µm Gold	
64322-1339	0.75	1.60 to 1.90		High Performing version 1.27µm Gold	
64322-1349	0.35	1.25 to 1.40	22, 24	High Performing version 1.27µm Gold	
64322-1359	0.50	1.40 to 1.70		High Performing version 1.27µm Gold	

1.50mm (.059") Width CMC CP Female Crimp Terminal

64323

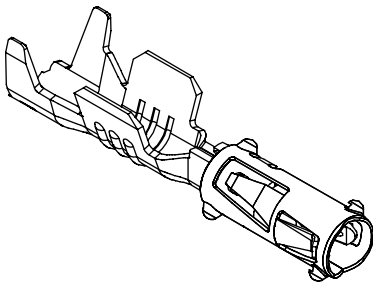

Features and Benefits

- Two piece terminal design
- Tang locking system
- Robust design with fully protected beam
- Various wire size compatibility
- Available in tin and gold plating

Reference Information

Product Specification:

Please refer to Product Specification of the relevant CMC connector

Mates With: CMC connector series 64318, 64319, 64320 and 64321

Designed In: Millimeters

Electrical

Voltage: 250 V AC

Current: *

12.0A for CMC CP 1.50mm (.059") terminal (2.0mm² wire)

Contact Resistance: CMC CP 1.50mm (.059")—4 milliohms max.

Dielectric Withstanding Voltage: 1000V AC for 1 min.

Insulation Resistance: 100 Megohms min.

Mechanical

Contact Insertion Force into Housing (Sealed Connector):

CMC CP 1.50mm (.059")—20.00N min.

Wire Pull-Out Force: 100.00N min. for wire size of 0.50mm²

Mating/Unmating Force:

Please refer to Product Specification of the relevant

CMC connector the terminal is used with

Durability: 20 mating cycles

Physical

Contact: Phosphor Bronze

Plating: Tin and Gold

Insulation Diameter: See table

* Current tested on a 5 terminals loaded connector, current for temperature increase of 40°C

Order No.	Wire Size (mm ²)	Wire Insulation Diameter (mm)	Wire Size (AWG)	Plating	Lead-Free
64323-1029	0.50 to 1.00	1.40 to 2.15	18, 20	Tin	Yes
64323-1039	> 1.00 to 2.00	2.10 to 2.80	14, 16	Tin	
64323-1219	> 1.00 to 2.00	2.10 to 2.80	14, 16	1.27µm Gold	
64323-1319	0.50 to 1.00	1.40 to 2.15	18, 20	1.27µm Gold	

2.80mm (.110") Width CMC CP Female Crimp Terminal

64324
With Linked Wire Seal

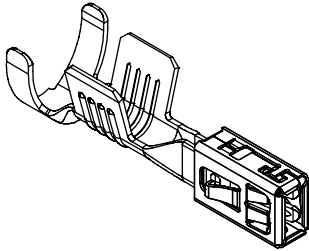

Features and Benefits

- Two piece terminal design
- Tang locking system
- Robust design with fully protected beam
- Various wire size compatibility
- Available in tin and gold plating

Reference Information

Product Specification:
Please refer to Product Specification of the relevant CMC connector
Mates With: CMC connector series 64318, 64321 and CMC wire seal series 64325
Designed In: Millimeters

Electrical

Voltage: 250V AC
Current: *21.0A for CMC CP 2.80mm (.110") terminals (5.0mm²)
Contact Resistance: CMC CP 2.80mm (.110")—3 milliohms max.
Dielectric Withstanding Voltage: 1000V AC for 1 min.
Insulation Resistance: 100 Megohms min.

* Current tested on a fully loaded connector, current for temperature increase of 40°C

Mechanical

Contact Insertion Force into Housing (Sealed Connector):
CMC CP 2.80mm (.110")—25.00N min
Wire Pull-Out Force: 100.00N min. for wire size of 0.50mm²
Mating/Unmating Force:
Please refer to Product Specification of the relevant CMC connector the terminal is used with
Durability: 20 mating cycles

Physical

Contact: Phosphor Bronze
Plating: Tin and Gold
Insulation Diameter: See table

Order No.	Wire Size (mm ²)	Wire Insulation Diameter (mm)	Plating	Lead-Free
64324-1019	> 3.0 to 5.0	3.40 to 4.00	Tin	Yes
64324-1029	> 2.0 to 3.0	2.65 to 3.45	Tin	
64324-1039	> 1.0 to 2.0	2.10 to 2.80	Tin	
64324-1049	0.5 to 1.0	1.40 to 2.15	Tin	
64324-1119	> 3.0 to 5.0	3.40 to 4.00	1.27µm Gold	
64324-1129	> 2.0 to 3.0	2.65 to 3.45	1.27µm Gold	
64324-1139	> 1.0 to 2.0	2.10 to 2.80	1.27µm Gold	
64324-1149	0.5 to 1.0	1.40 to 2.15	1.27µm Gold	

www.molex.com/product/cmc.html

3.33mm (.131")/ 4.20mm (.165") Pitch NSSC Wire-to-Wire Hybrid Receptacle Housing

98122
Triple Rows
Sealed

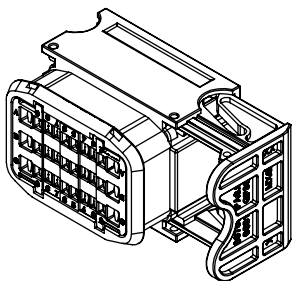

Features and Benefits

- Secondary locking
- Slide to reduce mating force
- Slide orientation right or left
- Grommet seal and perimeter seal
- Color keying
- Two wire sizes: hybrid 1.5 and 2.8mm (.060 and .110") connector

Reference Information

Packaging: Box
Mates With: 98761
Use With: NSSC 1.5 terminal
Designed In: Millimeters

Electrical

Voltage: 13V
Current: 1.5mm (.060")—13.0A
2.8mm (.110")—22.0A
(see Sicma terminal specification for 1.5 and 2.8mm terminals)
Contact Resistance: 1.5mm (.060")—5 milliohms max.
2.8mm (.110")—4 milliohms max.
Dielectric Withstanding Voltage: 1000 VAC or 1400 VDC
Insulation Resistance: 100 Megohms min.

Mechanical

Contact Insertion Force:
1.5mm (.060")—25.0N (5.62 lb) max.
2.8mm (.110")—30.0N (6.74 lb) max.
Contact Retention to Housing: 120.0N (26.98 lb) min.
Wire Pull-Out Force: 120.0N (26.98 lb)
Mating Force: 85.0N (19.11 lb) max. (fully loaded)
Unmating Force: 85.0N (19.11 lb) max. (fully loaded)
Durability: 10 mating cycles

Physical

Housing: Glass-filled PBT Polyester, UL 94V-HB
Sealing Class: 500 mbars (7.25 psi)

Circuits	Order No.	Color	Slide Orientation
30	98122-1001	Black	Right
	98122-1002	Brown	
	98122-1003	Gray	
	98122-1005	Black	Left
	98122-1006	Brown	
	98122-1007	Gray	

3.33mm (.131")/ 4.20mm (.165") Pitch NSSC Wire-to-Wire Hybrid Plug Housing

98761
Triple Rows
Sealed

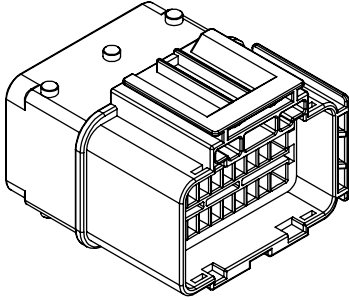

Circuits	Order No.	Color
30	98761-1001	Black
	98761-1002	Brown
	98761-1003	Gray

Features and Benefits

- Secondary locking feature
- Slide to reduce mating force
- Slide orientation right or left possible
- Grommet seal and perimeter seal
- Color keying
- Two wire sizes: hybrid 1.50 and 2.80mm (.060 and .110") connector

Reference Information

Packaging: Box
Mates With: 98122
Use With: Sicma 1.5 and 2.8mm (.060 and .110") male terminals
Designed In: Millimeters

Electrical

Voltage: 13V
Current: 1.5mm (.060")—13.0A
2.8mm (.110")—22.0A
(see FCI Sicma terminal specification for 1.5 and 2.8mm terminals)
Contact Resistance: 1.5mm (.060")—5 milliohms max.
2.8mm (.110")—4 milliohms max.
Dielectric Withstanding Voltage: 1000V AC or 1400V DC
Insulation Resistance: 100 Megohms min.

Mechanical

Contact Insertion Force:
1.5mm (.060")—15.0N (3.37 lb) max.
2.8mm (.110")—20.0 N (4.50 lb) max.
Contact Retention to Housing: 120.0 N (26.98 lb) min.
Wire Pull-Out Force: 120.0N (26.98 lb)
Mating Force: 85.0N (19.11 lb) max. (fully loaded)
Unmating Force: 85.0N (19.11 lb) max. (fully loaded)
Durability: 10 mating cycles

Physical

Housing: Glass-filled PBT Polyester, UL 94-HB
Sealing Class: 500 mbars (7.25 psi)

Bulb Socket Signal Terminals

35464/35438

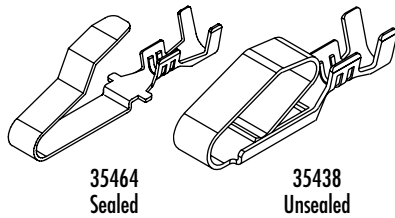

Features and Benefits

- Positive locking type (35464)
- Locking tang type (35438)

Reference Information

Product Specification: 35464—PS-35842-001
35438—PS-35532-001

Packaging: Reel

Use With: 35464—35842 and 35843 sockets and
35903-0096 wire seal

35438—35532 and 35533 sockets

Designed In: Millimeters

Electrical

Voltage: 12V

Current:

Wire Size	Current
0.50 mm ²	5A
0.85 mm ²	7A

Contact Resistance: 10 milliohms max.

Dielectric Withstanding Voltage: 1000V AC

Insulation Resistance: 100 Megohms min.

Mechanical

Contact Insertion Force: 3.0 kgf max.

Contact Retention to Housing: 35464—6.0 kgf min.

35438—5.0 kgf min.

Physical

Contact: Phosphor Bronze

Plating: Contact Area—Unplated

Insulation Diameter: 35464—1.60 to 2.30mm

(.063 to .091") max.

35438—3.00 to 3.60mm

(.118 to .142") max.

Strip Length: 35464—4.80 to 5.20mm (.189 to .205") max.

35438—3.00 to 3.60mm (.118 to .142") max.

Order No.	Description	Wire Range (mm ²)	Lead-free
35464-8000	Sealed	AVS (AVSS) 0.50-0.85	Yes
35438-8000	Unsealed		

www.molex.com/customer.html?seriesNumber=35464

Bulb Socket Earth Terminals

35465/35439

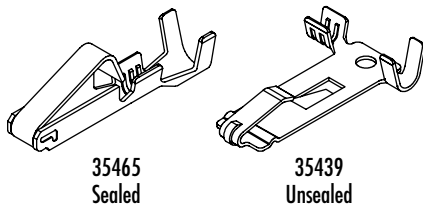

Features and Benefits

- Locking tang types
- 35439 is right angle for easier affixing to ground shell on bulb

Reference Information

Product Specification: 35465—PS-35842-001
35439—PS-35532-001

Packaging: Reel

Use With: 35465—35842 and 35843 sockets and
35903-0106 wire seal

35439—35532 and 35533 sockets

Designed In: Millimeters

Electrical

Voltage: 12V

Current:

Wire Size	Current
0.50mm ²	5A
0.85mm ²	7A

Contact Resistance: 10 milliohms max.

Dielectric Withstanding Voltage: 1000V AC

Insulation Resistance: 100 Megohms min.

Mechanical

Contact Insertion Force: 3.0 kgf max.

Contact Retention to Housing: 35465—6.0 kgf min.

35439—5.0 kgf min.

Physical

Contact: Phosphor Bronze

Plating: Unplated

Insulation Diameter: 35465—1.60 to 1.90mm

(.063 to .075") max.

35439—1.80 to 2.80mm

(.071 to .110") max.

Strip Length: 35465—4.80 to 5.20mm (.189 to .205") max.

35439—3.00 to 3.60mm (.118 to .142") max.

Order No.	Description	Wire Range (mm ²)	Lead-free
35465-8000	Sealed	AVS (AVSS) 0.50-0.85	Yes
35439-8000	Unsealed		

Bulb Socket

35843

Sealed, Single

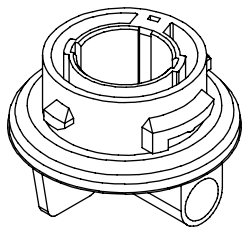

Features and Benefits

- Used with: 21/5W for double bulb 21W for single bulb
- High temperature material
- Compact size provides space saving
- Easy insertion "push-to-seat" terminal design provides cost savings
- Bottom flange enables easy assembly with lamp
- Simplified lamp design by standardization of light center length
- Silicone wire seal provides good sealing

Reference Information

Product Specification: PS-35842-001
 Packaging: Bag
 Mates With: Lamp
 Use With: 35464 and 35465
 Designed In: Millimeters

Electrical

Voltage: 12V
 Current: 7.0A max.
 Contact Resistance: 10 milliohms max.
 Dielectric Withstanding Voltage: 1000V AC
 Insulation Resistance: 500V DC 100 Megohms min.

Mechanical

Contact Insertion Force: 3.0 kgf max.
 Contact Retention Force: 6.0 kgf min.
 Wire Pull-Out Force: 58.3N (13.23 lb) min.
 Durability: 50 cycles

Physical

Housing: High-temperature Polyamide, UL 94V-2

Order No.	Type	Color
35843-1205	A	Gray
35843-1206		White
35843-1210	B	Natural
35843-1211		Black
35843-1215		Gray
35843-1216		White
35843-1217	C	Brown
35843-1221		Black
35843-1225		Gray
35843-1226		White
35843-1227		Brown

Order No.	Type	Color
35843-1240	D	Natural
35843-1245		Gray
35843-1246		White
35843-1247		Brown
35843-1230	EC	Natural
35843-1235		Gray
35843-1236		White
35843-1237		Brown

www.molex.com/customer.html?seriesNumber=35843

Bulb Socket

35842

Sealed, Double

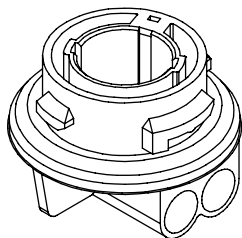

Features and Benefits

- Used with: 21/5W for double bulb 21W for double bulb
- High temperature material
- Compact size provides space saving
- Easy insertion "push-to-seat" terminal design provides cost savings
- Bottom flange enables easy assembly with lamp
- Simplified lamp design by standardization of light center length
- Silicone wire seal provides good sealing

Reference Information

Product Specification: PS-35842-001
 Packaging: Bag
 Mates With: Lamp
 Use With: 35464 and 35465
 Designed In: Millimeters

Electrical

Voltage: 12V
 Current: 7.0A max.
 Contact Resistance: 10 milliohms max.
 Dielectric Withstanding Voltage: 1000V AC
 Insulation Resistance: 500V DC 100 Megohms min.

Mechanical

Contact Insertion Force: 3.0 kgf max.
 Contact Retention Force: 6.0 kgf min.
 Wire Pull-Out Force: 58.3N (13.23 lb) min.
 Durability: 50 cycles

Physical

Housing: High-temperature Polyamide, UL 94V-2

Order No.	Type	Color
35842-1301	A	Black
35842-1305		Gray
35842-1306		White
35842-1307		Brown
35842-1315	B	Gray
35842-1316		White
35842-1317		Brown

PT Bulb Sockets

35842

Double Filament Type Sealed

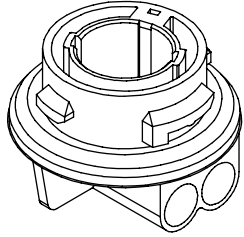

Features and Benefits

- Used with P21/5W lamp
- Durable mineral-filled material provides stable performance and helps prevent glass fogging
- Compact size provides space savings
- Easy insertion "push-to-seat" terminal design provides cost savings
- Bottom flange enables easy assembly with lamp
- Simplified lamp design by standardization of light center length

Reference Information

Product Specification: PS-35842-001

Packaging: Bag

Use With: 35464 and 35465 terminals and P21/5W type lamps

Designed In: Millimeters

Electrical

Voltage: 12V

Current: 7.0A max.

Dielectric Withstanding Voltage: 1000V AC

Insulation Resistance: 100 Megohms min.

Mechanical

Contact Insertion Force: 3.0 kgf max.

Contact Retention Force: 6.0 kgf min.

Wire Pull-Out Force: 0.50mm²—6.0 kgf
0.85mm²—10.0 kgf

Physical

Housing: Polyamide 66, mineral filled

Order No.	Type	Bulb	Bulb Cap (Base)	Light Center Length (mm)	Keying Type	Color*
35842-1305	Double, Sealed	P21/5W	BAY15d	31.8	A	Gray
35842-1315					B	

*Contact factory for other color options

PT Bulb Sockets

35532

Double Filament Type Unsealed

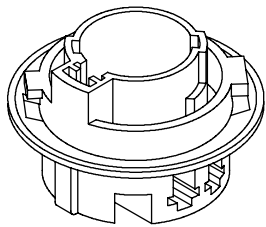

Features and Benefits

- Used with P21/5W lamp
- Durable mineral-filled material provides stable performance and helps prevent glass fogging
- Compact size provides space savings
- Easy insertion "push-to-seat" terminal design provides cost savings
- Bottom flange enables easy assembly with lamp
- Simplified lamp design by standardization of light center length

Reference Information

Product Specification: PS-35532-001

Packaging: Bag

Use With 35438 and 35439 terminals and P21/5W type lamps

Designed In: Millimeters

Electrical

Voltage: 300V

Current: 7.0A max.

Dielectric Withstanding Voltage: 1000V AC

Insulation Resistance: 100 Megohms min.

Mechanical

Contact Insertion Force: 3.0 kgf max.

Contact Retention Force: 5.0 kgf min.

Wire Pull-Out Force: 0.50mm²—6.0 kgf
0.85mm²—10.0 kgf

Physical

Housing: Polyamide 66, mineral filled

Order No.	Type	Bulb	Bulb Cap (Base)	Light Center Length (mm)	Keying Type	Color*
35532-0305	Double, Unsealed	P21/5W	BAY15d	31.8	A	Gray

*Contact factory for other color options

PT Bulb Sockets

35843

Single Filament Type Sealed

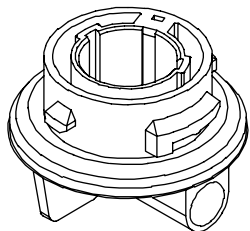

Features and Benefits

- Used with P21W lamp
- Durable mineral-filled material provides stable performance and helps prevent glass fogging
- Compact size provides space savings
- Easy insertion "push-to-seat" terminal design provides cost savings
- Bottom flange enables easy assembly with lamp
- Simplified lamp design by standardization of light center length

Reference Information

Product Specification: PS-35842-001
 Packaging: Bag
 Use With: 35464 and 35465 terminals and P21W type lamps
 Designed In: Millimeters

Electrical

Voltage: 12V
 Current: 7.0A max.
 Dielectric Withstanding Voltage: 1000V AC
 Insulation Resistance: 100 Megohms min.

Mechanical

Contact Insertion Force: 3.0 kgf max.
 Contact Retention Force: 6.0 kgf min.
 Wire Pull-Out Force: 0.50mm²—6.0 kgf
 0.85mm²—10.0 kgf

Physical

Housing: Polyamide 66, mineral filled

Order No.	Type	Bulb	Bulb Cap (Base)	Light Center Length (mm)	Keying Type	Color*
35843-1205	Single, Sealed	P21W	BA15s	31.8	A	Gray
35843-1215					B	
35843-1225					C	
35843-1245					D	
35843-1235					EC	
		PY21W	BAU15s			

*Contact factory for other color options

www.molex.com/customer.html?seriesNumber=35843

PT Bulb Sockets

35533

Single Filament Type Unsealed

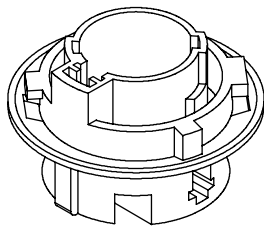

Features and Benefits

- Used with P21W lamp
- Durable mineral-filled material provides stable performance and helps prevent glass fogging
- Compact size provides space savings
- Easy insertion "push-to-seat" terminal design provides cost savings
- Bottom flange enables easy assembly with lamp
- Simplified lamp design by standardization of light center length

Reference Information

Product Specification: PS-35532-001
 Packaging: Bag
 Use With: 35438 and 35439 terminals and P21W type lamps
 Designed In: Millimeters

Electrical

Voltage: 300V
 Current: 7.0A max.
 Dielectric Withstanding Voltage: 1000V AC
 Insulation Resistance: 100 Megohms min.

Mechanical

Contact Insertion Force: 3.0 kgf max.
 Contact Retention Force: 5.0 kgf min.
 Wire Pull-Out Force: 0.50mm²—6.0 kgf
 0.85mm²—10.0 kgf

Physical

Housing: Polyamide 66, mineral filled

Order No.	Type	Bulb	Bulb Cap (Base)	Light Center Length (mm)	Keying Type	Color*
35533-0205	Single, Unsealed	P21W	BA15s	31.8	A	Gray
35533-0225					C	
35533-0215					B	
		PY21W	BAU15s			

*Contact factory for other color options

Wedge Bulb Socket Terminal

35477

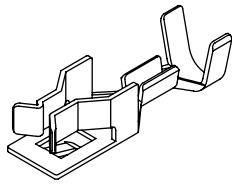

Features and Benefits

- Two-point contact design for secure electrical connection
- Locking tang type

Reference Information

Product Specification: 68147-001
 Packaging: Reel
 Use With: 68147 and 49505 sockets and 49505-9001 wire seal
 Designed In: Millimeters

Electrical

Voltage: 12V
 Current:

Wire Size	Current
0.5 mm ²	5.0A max.
0.85 mm ²	7.0A max.

Dielectric Withstanding Voltage: 1000V AC
 Insulation Resistance: 100 Megohms min.

Mechanical

Contact Retention to Housing: 6.0 kgf min.

Physical

Contact: Brass
 Plating: Contact Area—Pre-tin
 Insulation Diameter: 2.30mm (.091") max.
 Strip Length: 5.00 to 5.50mm (.197 to .217")

Order No.	Description	Wire Range (mm ²)	Lead-free
35477-9002	Sealed	AVS (AVSS) 0.3-0.85	Yes

Wedge Bulb Socket

68147

Single, Wire Type Sealed

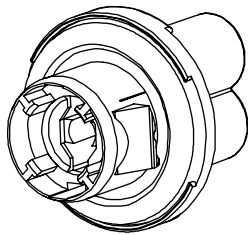

Features and Benefits

- Used with W5W/W16W lamps
- Durable mineral-filled material provides stable performance and helps prevent glass fogging
- Robust design provides rugged protection against harsh environments and vibration
- Silicone wire and gasket seals provide good sealing

Reference Information

Product Specification: PS-68147-001 and PS-48905-001
 Packaging: Bag
 Mates With: Lamp
 Use With: 35477 terminal
 Designed In: Millimeters

Electrical

Voltage: 12V
 Current: 7.0A max.
 Dielectric Withstanding Voltage: 1000V AC
 Insulation Resistance: 100 Megohms min.

Mechanical

Contact Retention Force: 6.0 kgf min.

Physical

Polyamide 66, mineral filled

Order No.	Type	Bulb	Bulb Cap (Base)	Light Center Length (mm)	Color*
49505-0215	Single, Sealed	W16W (T5)	W2.1 * 9.5d	26.5	Gray
68147-0215		WSW (T3 1/4)	W2.1 * 9.5d	13.8	

*Contact factory for other color options

HSAutoLink™ Cable Assembly

111015/111082/111083

USCAR USB Standard A Receptacle
to USCAR USB Plug

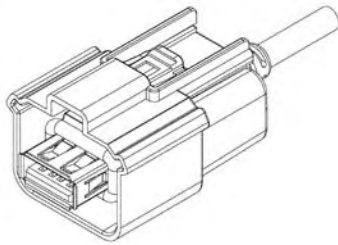

Latching Shroud

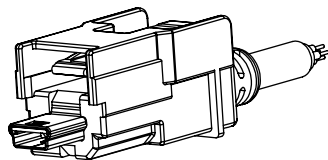

Plug

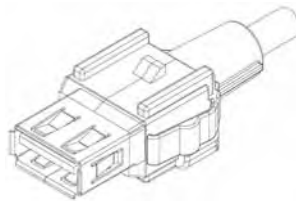

Unshrouded

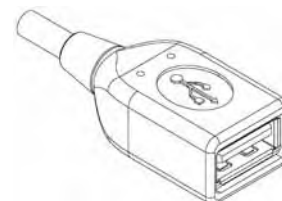

Overmolded

Features and Benefits

- Rugged connectors meet USCAR and other automotive OEM requirements
- Superior signal performance and reduced Electro Magnetic Interference (EMI)
- USCAR-30 compliant
- High durability Standard A receptacle
- Package size optimization of the consumer interface

Reference Information

Packaging: Bag
 Mates With: USCAR USB Keyed Headers—Right Angle (49616), Vertical (104004)
 Use With: In-Line Cable Assemblies 111005 for separating link applications
 Designed In: Millimeters

Electrical

Voltage: 30V
 Current: 1.5A
 Contact Resistance: 50 milliohms max.
 Insulation Resistance: 150 Megohms min.

Mechanical

USB Standard A
 Mating Force: 35N (7.87 lb) max.
 Unmating Force: 10N (2.25 lb) min.
 Durability: 5,000 cycles*
 *Durability results range from 5,000 cycles to as many as 20,000 cycles based on test methods used
 Plug: Shielded 5 Pin
 Mating Force: 45N (10.12 lb) max.
 Retention Force: 110N (24.73 lb) max.
 Durability: 25 cycles

Physical

Housing: PBT
 Interface Plating: Gold over Nickel

Order No.	Plug Polarization	Standard A	Length*
111015-0100	A	Latching Shroud	0.50m (1.64')
111015-0101	B		
111015-0200	A		1.00m (3.28')
111015-0201	B		
111015-0300	A		1.50m (4.92')
111015-0301	B		
111082-0001	A	Overmolded	0.50m (1.64')
111082-0002	B		
111083-0001	A	Unshrouded	
111083-0002	B		

*Other lengths available, contact Molex.

HSAutoLink™ Cable Assembly

111014 USCAR USB Plug to Plug

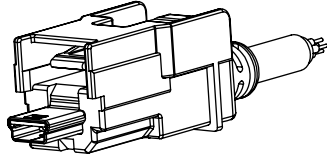

Features and Benefits

- Rugged connectors meet USCAR and other automotive OEM requirements
- Superior signal performance and reduced Electro Magnetic Interference (EMI)
- USCAR-30 compliant

Reference Information

Packaging: Bag
 Mates With: USCAR USB Keyed Headers—Right Angle (49616), Vertical (104004)
 Use With: Cable Assemblies 111005
 Designed In: Millimeters

Electrical

Voltage: 30V
 Current: 1.5A
 Contact Resistance: 50 milliohms max.
 Insulation Resistance: 150 Megohms min.

Mechanical

Plug: Shielded 5 Pin
 Mating Force: 45N (10.12 lb) max.
 Unmating Force: 45N (10.12 lb) max.
 Retention Force: 110N (24.73 lb) min.
 Durability: 25 cycles
 Inline Receptacle: Shielded 5 Pin
 Mating Force: 45N (10.12 lb) max.
 Unmating Force: 45N (10.12 lb) max.
 Retention Force: 110N (24.73 lb) min.
 Durability: 25 cycles

Physical

Housing: PBT
 Interface Plating: Gold over Nickel

Order No.	In-Line Receptacle	Plug Polarization	Length*
111014-5000	A	A	0.50m (1.64')
111014-5001		B	
111014-5003	B	A	
		B	

*Other lengths available, contact Molex.

HSAutoLink™ Cable Assembly

111005 USCAR USB Plug to In-line Receptacle

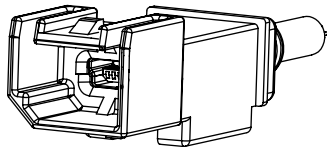

Features and Benefits

- Rugged connectors meet USCAR and other automotive OEM requirements
- Superior signal performance and reduced Electro Magnetic Interference (EMI)
- USCAR-30 compliant
- Integrated retainer slot for standard Christmas-tree clip

Reference Information

Packaging: Bag
 Mates With: USCAR USB Keyed Headers—Right Angle (49616), Vertical (104004)
 Use With: Cable Assemblies 111014, 111015
 Designed In: Millimeters

Electrical

Voltage: 30V
 Current: 1.5A
 Contact Resistance: 50 milliohms max.
 Insulation Resistance: 150 Megohms min.

Mechanical

Plug: Shielded 5 Pin
 Mating Force: 45N (10.12 lb) max.
 Unmating Force: 45N (10.12 lb) max.
 Retention Force: 110N (24.73 lb) min.
 Durability: 25 cycles
 Inline Receptacle: Shielded 5 Pin
 Mating Force: 45N (10.12 lb) max.
 Unmating Force: 45N (10.12 lb) max.
 Retention Force: 110N (24.73 lb) min.
 Durability: 25 cycles

Physical

Housing: PBT
 Interface Plating: Gold over Nickel

Order No.	In-Line Receptacle	Plug Polarization	Length*
111005-1010	A	A	0.50m (1.64')
111005-1020		B	
111005-1030	B	A	
111005-1040		B	

*Other lengths available, contact Molex.

HSAutoLink™ Header

104004 Vertical

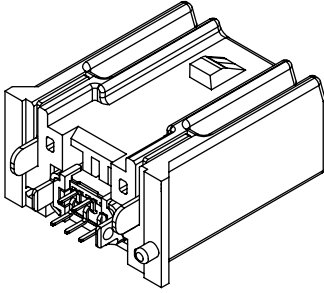

Order No.	Plug Polarization*
104004-0501	A
104004-0505	B

*For applications where additional plug polarizations are required, contact Molex.

Features and Benefits

- Provides a proven interface offering good mechanical performances
- USCAR-30 compliant
- Meets all USB 2.0 electrical and EMI requirements
- Compatible with Lead-free through-hole reflow process (Pin-in-Paste)

Reference Information

Packaging: Tray
 Mates With: Cable Assemblies (Series 111005, 111014, 111015, 111019, 111020 and 111041)
 Designed In: Millimeters

Electrical

Voltage: 16V AC min.
 Current: 1.0A max.
 Contact Resistance: 50 milliohms max.
 Insulation Resistance: 150 Megohms min.

Mechanical

Insertion Force to PCB: 20N (4.50 lb) max.
 Mating Force: 45N (10.12 lb) max.
 Unmating Force: 45N (10.12 lb) max.
 Durability: 25 cycles min.

Physical

Housing: LCP High-Temperature Plastic
 Contact: Copper Alloy
 Plating: Contact Area—0.75µm min. Gold
 Solder Tail Area—3.0µm min. Tin
 Underplating—1.25µm min. Nickel
 PCB Thickness: 1.60mm (.063")

HSAutoLink™ Header

49616 Right Angle

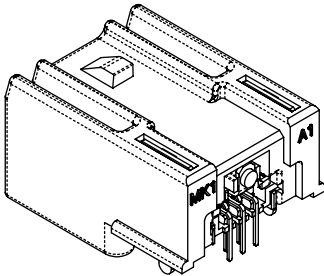

Order No.	Plug Polarization*
49616-0711	A
49616-0715	B

*For applications where additional plug polarizations are required, contact Molex.

Features and Benefits

- Provides a proven interface offering good mechanical performances
- USCAR-30 compliant
- Meets all USB 2.0 electrical and EMI requirements
- Compatible with Lead-free through-hole reflow process (Pin-in-Paste)

Reference Information

Packaging: Tray
 Mates With: Cable Assemblies (Series 111005, 111014, 111015, 111019, 111020 and 111041)
 Designed In: Millimeters

Electrical

Voltage: 16.0V AC min.
 Current: 1.0A max.
 Contact Resistance: 50 milliohms max.
 Insulation Resistance: 150 Megohms min.

Mechanical

Insertion Force to PCB: 20N (4.50 lb) max.
 Mating Force: 45N (10.12 lb) max.
 Unmating Force: 45N (10.12 lb) max.
 Durability: 25 cycles min.

Physical

Housing: LCP High-Temperature Plastic
 Contact: Copper Alloy
 Plating: Contact Area—0.75µm min. Gold
 Solder Tail Area—3.0µm min. Tin
 Underplating—1.25µm min. Nickel
 PCB Thickness: 1.60mm (.063")

HSAutoLink™ Cable Assembly

111019/111041 LVDS 2- and 4-Wire

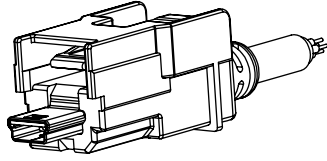

Plug

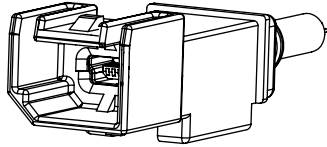

In-line Receptacle

Features and Benefits

- Rugged connectors meet USCAR and other automotive OEM requirements
- Support 2 or 4 wire LVDS technology
- Use of high electrical performance Shielded Twisted Pair cable construction
- Interconnect system already evaluated with most of major LVDS chip suppliers for automotive application

Reference Information

Packaging: Bag
 Mates With: USCAR USB Keyed Headers—Right Angle (Series 49616), Vertical (Series 104004)
 Designed In: Millimeters

Electrical

Voltage: 30V
 Current: 1.0A
 Contact Resistance: 50 milliohms max.
 Insulation Resistance: 150 Megohms min.

Mechanical

Plug: Shielded 5 Pin
 Mating Force: 45N (10.12 lb) max.
 Unmating Force: 45N (10.12 lb) max.
 Retention Force: 110N (24.73 lb) min.
 Durability: 25 cycles

Inline Receptacle: Shielded 5 Pin
 Mating Force: 45N (10.12 lb) max.
 Unmating Force: 45N (10.12 lb) max.
 Retention Force: 110N (24.73 lb) min.
 Durability: 25 cycles

Physical

Housing: PBT
 Interface Plating: Gold over Nickel

Plug to Plug Cable Assembly

Wires	Order No.	In-Line Receptacle	Plug Polarization	Length*
2	111041-5001	A	A	0.50m (1.64')
	111041-5000		B	
	111041-5002			
4	111019-5001	A	A	
	111019-5000		B	
	111019-5002			

In-Line Receptacle to Plug Cable Assembly

Wires	Order No.	In-Line Receptacle	Plug Polarization	Length*
2	111041-2010	A	A	0.50m (1.64')
	111041-2030		B	
	111041-2020	B	A	
	111041-2040		B	
4	111019-2010	A	A	
	111019-2030		B	
	111019-2020	B	A	
	111019-2040		B	

*Other lengths available, contact Molex.

HSAutoLink™ Interconnect System High-Speed In-Vehicle Databus

Markets and Applications

Markets

- Automotive
- Farm Equipment
- Motorcycle
- All-terrain Vehicles
- Watercraft
- Aircraft

Applications

- Infotainment
- Telematic Devices
- Safety and Collision Avoidance Cameras
- In-Vehicle Applications

Printed Circuit Assemblies

Molex offers a wide range of custom printed circuit board assemblies. With a full range of capability from complete design and manufacturing to higher levels of integration into packaged assemblies such as combined USB/Auxiliary Jack convenience ports.



Customer Convenience Port—Front View



Customer Convenience Port—Rear View



PCB—Front View



PCB—Rear View

Auxiliary Ports, Repeater Modules and Accessories

At the highest level of integration, Molex provides design services and manufactured solutions for active repeater modules. These modules are designed to customer defined specifications and provide convenience features such as USB hubs, repeater, auxiliary port, analog audio/video input, and SD card slots. Molex can also provide a simple, low-cost solution for cabled bezel mount convenience ports with USB and Aux Port. Each is provided by Molex technical development teams to meet specific requirements.



Repeater Modules—Right Angle,
Polarization A and B

Custom Cable Assemblies

In addition to the standard cabled configurations, Molex provides flexible solutions meeting the needs of our customers extreme packaging requirements by offering various cable exit options.



Auxiliary Port Connector



Latching Shroud

AK2 Squib Connectors

90° Ferrite AK2 Squib Pigtails



Features and Benefits

- Scoop proof(Kojiri) interface (AK2 interface)
- Mates to 2 way interface Code 1, 2 and 3 per ISO-TS 19072-4 (13 dec 08) and USCAR 999-U-002-1-Z03 (RevA00) specifications
- Blocked Active CPA Button to prevent actuation before connector is fully mated
- Easy connector mating, even in blind mate conditions; greater than 3mm CPA/Actuator travel and manually serviceable
- Welded interconnection
- Superior Performance in filtering EMI with optimized ferrite design
- Delivered in different wire lengths, types and colors; contact Molex for customization

Reference Information

Packaging: Plastic bags in cardbox
 Mates With: AK2 retainer
 Use With: In-line Cable Assemblies
 Designed In: Millimeters

Electrical

Current Rating: 6,7A (T° rise < 55°) max.
 Insulation Resistance: 100 Megohms min.
 Contact Resistance: 10 milliohms max. before and after environmental exposure

Mechanical

CPA Engagement Force from Pre-lock to Final Lock (Unmated Connector): >100N during 10 sec min.
 One Step Mating System Mating Force: 45N max.
 Unmating Force with Primary Lock and CPA Engaged: 135N min.
 Unmating Force with Primary Lock and CPA disengaged: 75N max.
 Cable Axial Retention Force on Both Wires: 100N min.
 Polarization Effect: 100N min.

Physical

Plastic Components: PBT
 Interface Plating: Gold over Nickel
 Wires: 0.5² mm
 ELV and RoHS compliant

Description	Type and Material	Color
Housing	Code 1, PBT, 20% Glass Filled	Black
	Code 2, PBT, 20% Glass Filled	Light-Green
	Code 3, PBT, 20% Glass Filled	Yellow
Cover	PBT, 20% Glass Filled	Yellow
CPA		Red
Actuator	PBT, 15% Glass Filled	Yellow
Rec. Terminal	Copper Alloy: Gold Plated, 0.5 μm min.	
Cable	FLRY, 2x0.5 mm ² , or FLRYV-A: 2x0.5 mm ²	
Ferrite	Circuit-2	Grey

Sensor Capabilities

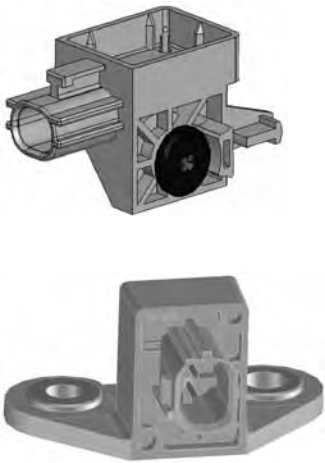

Features and Benefits

- Wide range of sensor types available for all applications
- Able to meet all Automotive industry requirements
- More than 10 years experience for development and production
- Molex HMLV (High Mix Low Volume) gives a competitive pricing for low and medium volumes
- Wide range of connectors available for all applications, ready to design-in
- Aluminum, brass or steel bushing in use
- Biscuit overmolding or stitched technologies available
- Pressfit pin (Eye-Of-Needle) already released at many customers
- If required: integration of custom specific parts like screws etc.
- If required: Welded interconnection
- If required: sealed and waterproof

Electrical

Derating [reduced value (20%)/Sn-Surface]*:
6A (T⁺ rise < 55°) at EON pin
Contact Resistance: < 0.5 milliohms before and after environmental exposure
Electrical Conductivity: 30 IACS

Mechanical

Mating Force: 100N min. avg. per EON pin
Unmating force: 20 N max. (after environmental testing)

Physical

Plastic Components: PBT/PA66/C42520
Interface plating: Tin, Gold or Silver
*This value is strongly limited by the conductor size of PCB.

Reference Information

Packaging: Tray or tube
Mates With: MOX connectors
Designed In: Millimeters

Automotive Sensors

Crash Sensors

Description	Features
ROSS—6-Way Roll Over Safety Sensor	PBT Housing 0.64mm compliant pins Gold plated pins (interface) Overmolded pin biscuit assembly Stainless steel bushings (3)
RSU—2-Way Remote Satellite Unit Sensor	PBT Housing Brass Bushing 0.64mm EON, Gold and Tin Pins Multiple anti-rotation tab offerings Internal ground pin attached to mounting Bushing Annealed Sealed
SSIS—2-Way Safety Side Impact Sensor	PBT Housing Brass Bushing 0.64mm EON Gold and Tin plating
	PBT Housing Aluminium Bushing and Screw 0.64mm EON Tin plating

Parking Sensors

Description	Features
RPA—3-Way Remote Parking Assistant	PA66 GF30% 0.64mm Brass, Soldering Tip PCB side, Tin plating Mating with Sealed Connector Insert Molding

Tire Pressure Sensors

Description	Features
TPMS—6-Way Tire Pressure Monitoring System	0.64mm EON compliant pins In-house high speed coil winding Tin plated pins Overmolded ferrite 100% in-house assembly Sealed

Typical Sensor Content

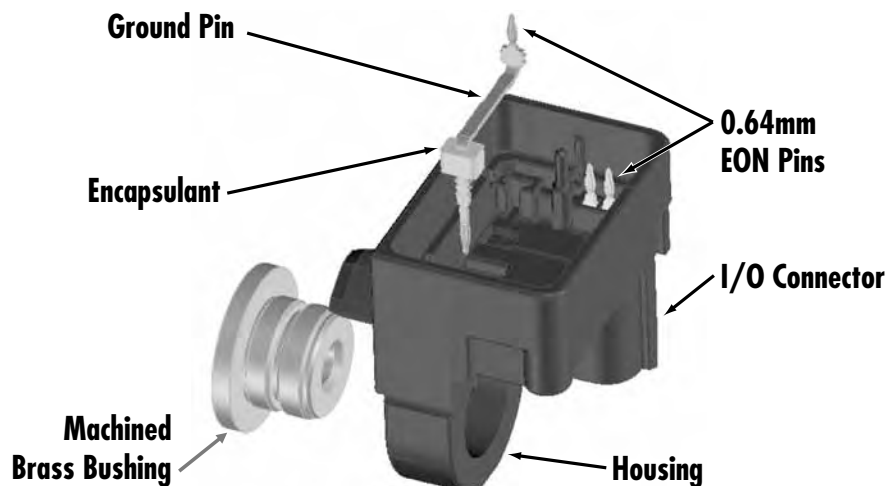

0.40 TO 1.60MM (.016 TO .063") PITCH
PCB and Wire Connectors

B

0.40mm (.016") Pitch

Product Matrix	B-2
Stacking Connectors	B-3 to B-12

0.50mm (.020") Pitch

Product Matrix	B-13
PCB Connectors	B-14
Stacking Connectors	B-15 to B-19

0.635mm (.025") Pitch

Product Matrix	B-20
Stacking Connectors	B-21 to B-23

0.80mm (.031") Pitch

Product Matrix	B-20
Stacking Connectors	B-24 to B-26

1.00mm (.039") Pitch

Product Matrix	B-27
Stacking Connectors	B-28 to B-29
Mezzanine	B-30 to B-32
Wire-to-Board	B-33 to B-35

1.25mm (.049") Pitch

Product Matrix	B-36, B-44
Wire-to-Board	
CLIK-Mate™	B-37 to B-38
PanelMate™	B-39 to B-40
Mini Mi II™	B-40 to B-42
Wire-to-Wire – Mini Mi II™	B-43
Wire-to-Board and Wire-to-Wire – PicoBlade™	B-45 to B-47
Board-In Connectors	B-48 to B-49
Board-to-Board ZIGZAG Connectors	B-48 to B-49

1.27mm (.050") Pitch

Product Matrix	B-54
Board-to-Board – SEARAY*	B-50

1.50mm (.059") Pitch

Product Matrix	B-51
Wire-to-Board – CLIK-Mate™	B-52 to B-53
High Speed Docking – Plateau HS Dock™	B-54 to B-55
High Speed Docking – Plateau HD Dock™ PG	B-56
Wire-to-Board – Pico-SPOX™	B-57 to B-58

1.60mm (.063") Pitch

Product Matrix	B-51
Detachable Board-to-Board Connector	B-59







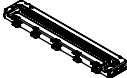

*SEARAY is a trademark of Samtec, Inc.

Visit www.molex.com to access more part numbers and product information, download sales drawings, product specifications, 3D models, place sample requests, and more.

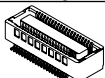
0.40mm (.016") Pitch

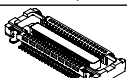
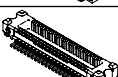
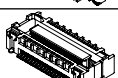
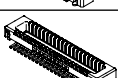
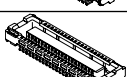
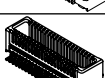
B

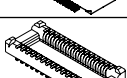
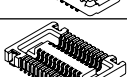
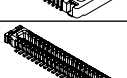
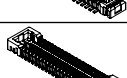
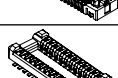
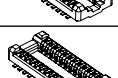
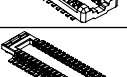
0.40 to 1.60mm (.016 to .063") Pitch PCB and Wire Connectors

Pitch	Series		Tradename	Description	Stacking Height
0.40mm (.016")	501083			PCB Receptacle, Vertical	
	501044			PCB Receptacle, Right Angle	
	501800			Cable Plug Assembly	
	54477		SlimStack™	Receptacle	4.00mm (.157")
	55339			Plug	4.00mm (.157")
	54765			Receptacle	1.50mm (.059")
	55604			Plug	1.50mm (.059")
	500913			Receptacle	1.80mm (.071")
	55909			Plug	1.50mm (.059")
	51338			Receptacle	1.50mm (.059")
	55526			Plug	3.50mm (.138")
	54684			Receptacle	3.50mm (.138")
	500027			Plug	0.95mm (.037")
	500024			Receptacle	0.95mm (.037")
	502430			Plug	1.00mm (.039")
	502426			Receptacle	1.00mm (.039")
	87820			Receptacle	0.95mm (.037")
	87819			Plug	0.95mm (.037")
	501594			Plug	0.90mm (.035")
	501591			Receptacle	0.90mm (.035")

0.40mm (.016") Pitch Wire-to-Board PCB Receptacle

501083
SMT, Vertical

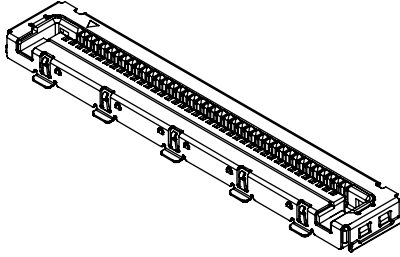

Circuits	Order No.	Lead-free
30	501083-3010	Yes
40	501083-4010	
50	501083-5010	

Features and Benefits

- Provides convenient top-side mating for hard-to-reach areas
- Polarization features help facilitate proper mating
- Grounding tabs provide shielding protection against ESD
- Friction lock provides secure mating retention
- Terminal design offers long wipe length

Reference Information

Product Specification: PS-501083-001
Packaging: Embossed tape
Mates With: 501800
Designed In: Millimeters

Electrical

Voltage: 30V max.
Current: 0.2A max.
Contact Resistance: 450 milliohms max.
Dielectric Withstanding Voltage: 125V AC/1 min.
Insulation Resistance: 100 Megohms min.

Physical

Housing: Black glass-filled heat resistant plastic, UL 94V-0
Contact: Copper Alloy
Plating: Gold over Nickel

0.40mm (.016") Pitch Wire-to-Board PCB Receptacle

501044
SMT, Right Angle

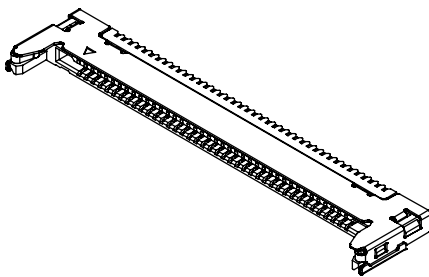

Circuits	Order No.	Lead-free
30	501044-3010	Yes
40	501044-4010	
50	501044-5010	

Features and Benefits

- Low profile of 1.15mm (0.45")
- Polarization features help facilitate proper mating
- Side grounding tabs provide shielding protection against ESD
- Friction lock provides secure mating retention
- Terminal design offers long wipe length

Reference Information

Product Specification: PS-501044-001
Packaging: Embossed tape
Mates With: 501800
Designed In: Millimeters

Electrical

Voltage: 30V max.
Current: 0.2A max.
Contact Resistance: 450 milliohms max.
Dielectric Withstanding Voltage: 125V AC/1 min.
Insulation Resistance: 100 Megohms min.

Physical

Housing: Black glass-filled heat resistant plastic, UL 94V-0
Contact: Copper Alloy
Plating: Gold over Nickel

0.40mm (.016") Pitch Wire-to-Board Plug Harness

501800

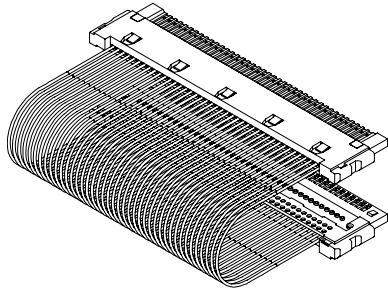

Order No.	Lead-free
501800-XXXX	Yes

Note: Contact Molex for ordering numbers and further details

Features and Benefits

- "Double-clamp" grounding method provides superior shielding and signal integrity
- IDT termination provides more reliable and efficient assembly versus solder methods
- UltrB-thin coaxial cable provides high speed and space savings

Reference Information

Product Specification: PS-501044-001/501083-001
 Packaging: Tray
 Mates With: 501044 and 501083
 Designed In: Millimeters

Electrical

Voltage: 30V max.
 Current: 0.2A max.
 Contact Resistance: 450 milliohms max.
 Dielectric Withstanding Voltage: 125V AC/1 min.
 Insulation Resistance: 100 Megohms min.

www.molex.com

0.40mm (.016") Pitch SlimStack™ Board-to-Board Plug

501594

**SMT, Dual Row
Vertical Stacking**

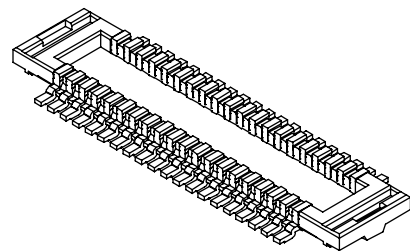

Features and Benefits

- Sizes 10 to 70 circuits
- Stacking Height: 0.90mm (.035")
- Fitting nails provide PCB hold-down and solder joint

Reference Information

Product Specification: PS-501591-002
 Packaging: Embossed tape
 Mates With: 501591
 Designed In: Millimeters

Electrical

Voltage: 50V max.
 Current: 0.3A max.
 Contact Resistance: 90 milliohms max.
 Dielectric Withstanding Voltage: 125V AC/1 min.
 Insulation Resistance: 100 Megohms min.

Physical

Housing: Glass-filled LCP, UL 94V-0
 Contact: Phosphor Bronze
 Plating: Gold over Nickel
 Fitting Nail: Phosphor Bronze, Tin over Nickel plating

Circuits	Order No.	Lead-free
10	501594-1011	Yes
12	501594-1211	
20	501594-2011	
22	501594-2211	
24	501594-2411	
26	501594-2611	
30	501594-3011	

Circuits	Order No.	Lead-free
34	501594-3411	Yes
40	501594-4011	
44	501594-4411	
50	501594-5011	
54	501594-5411	
70	501594-7011	

0.40mm (.016") Pitch SlimStack™ Board-to-Board Receptacle

501591
SMT, Dual Row
Vertical Stacking

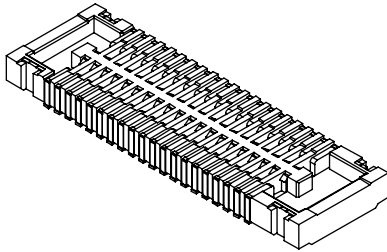

Features and Benefits

- Sizes 10 to 70 circuits
- Stacking Height: 0.90mm (.035")
- J-Lead SMT solder tails offer space savings
- Solder tabs provide PCB hold-down and solder joint

Reference Information

Product Specification: PS-501591-002
Packaging: Embossed tape
Mates With: 501594
Designed In: Millimeters

Electrical

Voltage: 50V max.
Current: 0.3A max.
Contact Resistance: 90 milliohms max.
Dielectric Withstanding Voltage: 125V AC/1 min.
Insulation Resistance: 100 Megohms min.

Physical

Housing: Glass-filled LCP, UL 94V-0
Contact: Phosphor Bronze
Plating: Gold over Nickel
Fitting Nail: Phosphor Bronze, Tin over Nickel plating

Circuits	Order No.	Lead-free
10	501591-1011	Yes
12	501591-1211	
20	501591-2011	
22	501591-2211	
24	501591-2411	
26	501591-2611	
30	501591-3011	

Circuits	Order No.	Lead-free
34	501591-3411	Yes
40	501591-4011	
44	501591-4411	
50	501591-5011	
54	501591-5411	
70	501591-7011	

0.40mm (.016") Pitch SlimStack™ Board-to-Board Plug

500027
SMT, Dual Row
Vertical Stacking

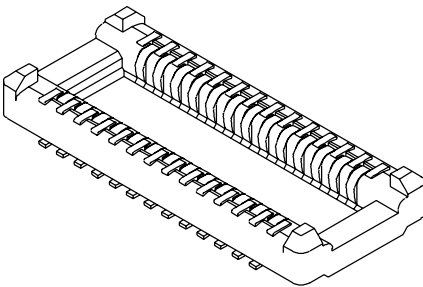

Features and Benefits

- Sizes 16 to 80 circuits
- Stacking Height: 0.95mm (.037")
- Fitting nails provide PCB hold-down and solder joint

Reference Information

Product Specification: PS-500024-011
Packaging: Embossed tape
Mates With: 500024
Designed In: Millimeters

Electrical

Voltage: 50V max.
Current: 0.1A max.
Contact Resistance: 90 milliohms max.
Dielectric Withstanding Voltage: 125V AC/1 min.
Insulation Resistance: 100 Megohms min.

Physical

Housing: LCP, UL 94V-0
Contact: Copper Alloy
Plating: Gold over Nickel
Fitting Nail: Copper Alloy, Tin over Nickel plating

Circuits	Order No.	Lead-free
16	500027-1641	Yes
20	500027-2041	
24	500027-2441	
30	500027-3041	
34	500027-3441	
40	500027-4041	

Circuits	Order No.	Lead-free
50	500027-5041	Yes
60	500027-6041	
64	500027-6441	
70	500027-7041	
80	500027-8041	

0.40mm (.016") Pitch SlimStack™ Board-to-Board Receptacle

500024
SMT, Dual Row
Vertical Stacking

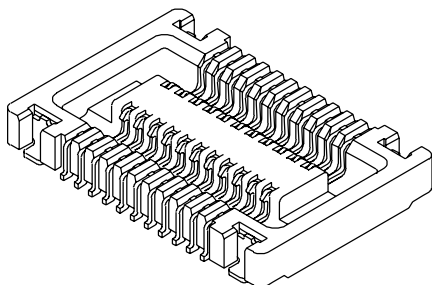

Features and Benefits

- Sizes 16 to 80 circuits
- Stacking Height: 0.95mm (.037")
- Fitting nails provide PCB hold-down and solder joint

Reference Information

Product Specification: PS-500024-011
Packaging: Embossed tape
Mates With: 500027
Designed In: Millimeters

Electrical

Voltage: 50V max.
Current: 0.1A max.
Contact Resistance: 90 milliohms max.
Dielectric Withstanding Voltage: 125V AC/1 min.
Insulation Resistance: 100 Megohms min.

Physical

Housing: LCP, UL 94V-0
Contact: Copper Alloy
Plating: Gold over Nickel
Fitting Nail: Copper Alloy, Tin over Nickel plating

Circuits	Order No.	Lead-free
16	500024-1681	Yes
20	500024-2081	
24	500024-2481	
30	500024-3071	
34	500024-3471	
40	500024-4071	

Circuits	Order No.	Lead-free
50	500024-5071	Yes
60	500024-6071	
64	500024-6471	
70	500024-7071	
80	500024-8071	

0.40mm (.016") Pitch SlimStack™ Board-to-Board Plug

502430
SMT, Dual Row
Vertical Stacking

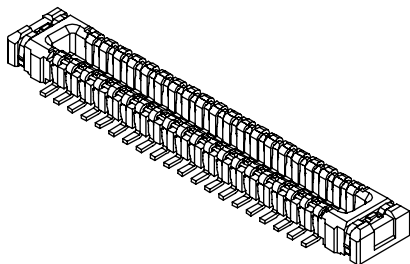

Features and Benefits

- Sizes 20 to 80 circuits
- Stacking Height: 1.00mm (.039")
- UltrB-narrow mated width of 2.60mm
- Fitting nails provide PCB hold-down and solder joint

Reference Information

Product Specification: PS-502426-001
Packaging: Embossed tape
Mates With: 502426
Designed In: Millimeters

Electrical

Voltage: 50V max.
Current: 0.3A max.
Contact Resistance: 80 milliohms max.
Dielectric Withstanding Voltage: 250V AC/1 min.
Insulation Resistance: 100 Megohms min.

Physical

Housing: Glass-filled LCP, UL 94V-0
Contact: Phosphor Bronze
Plating: Gold over Nickel
Fitting Nail: Phosphor Bronze, Gold over Nickel plating

Circuits	Order No.	Lead-free
20	502430-2010	Yes
26	502430-2610	
32	502430-3210	
40	502430-4010	

Circuits	Order No.	Lead-free
50	502430-5010	Yes
60	502430-6010	
64	502430-6410	
80	502430-8010	

0.40mm (.016") Pitch SlimStack™ Board-to-Board Receptacle

502426
SMT, Dual Row
Vertical Stacking

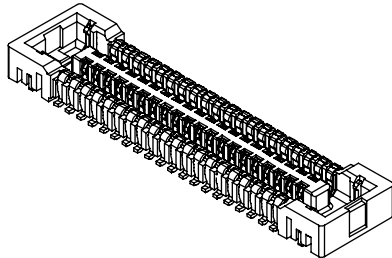

Features and Benefits

- Sizes 20 to 80 circuits
- Stacking Height: 1.00mm (.039")
- Ultra-narrow mated width of 2.60mm
- Fitting nails provide PCB hold-down and solder joint

Reference Information

Product Specification: PS-502426-001
Packaging: Embossed tape
Mates With: 502430
Designed In: Millimeters

Electrical

Voltage: 50V max.
Current: 0.3A max.
Contact Resistance: 80 milliohms max.
Dielectric Withstanding Voltage: 250V AC/1 min.
Insulation Resistance: 100 Megohms min.

Physical

Housing: Glass-filled LCP, UL 94V-0
Contact: Phosphor Bronze
Plating: Gold over Nickel
Fitting Nail: Phosphor Bronze, Gold over Nickel plating

Circuits	Order No.	Lead-free
20	502426-2010	Yes
26	502426-2610	
32	502426-3210	
40	502426-4010	

Circuits	Order No.	Lead-free
50	502426-5010	Yes
60	502426-6010	
64	502426-6410	
80	502426-8010	

0.40mm (.016") Pitch SlimStack™ Board-to-Board Plug

55339
SMT, Dual Row
Vertical Stacking

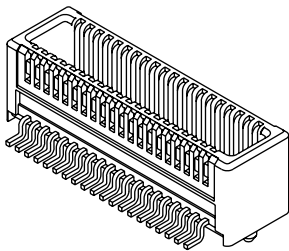

Features and Benefits

- Stacking height: 4.00mm (.157")
- Sizes 60 to 150 circuits
- SMT tail design provides strong solder joints and visible inspection
- Positioning pegs assist placement

Reference Information

Product Specification: PS-54477-008
Packaging: Embossed tape
Mates With: 54477
Designed In: Millimeters

Electrical

Voltage: 30V max.
Current: 0.3A max.
Contact Resistance: 60 milliohms max.
Dielectric Withstanding Voltage: 250V AC/1 min.
Insulation Resistance: 100 Megohms min.

Physical

Housing: Brown glass-filled LCP, UL 94V-0
Contact: Phosphor Bronze
Plating: Gold over Nickel

Circuits	Order No.	Lead-free
60	55339-0608	Yes
80	55339-0808	
100	55339-1008	
120	55339-1208	
150	55339-1508	

Note: Use only one connector per daughterboard in order to insure proper mating alignment

0.40mm (.016") Pitch SlimStack™ Board-to-Board Receptacle

54477
SMT, Dual Row
Vertical Stacking

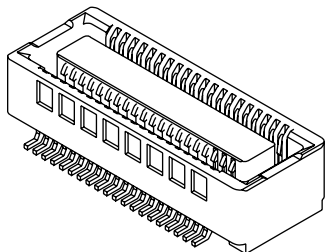

Circuits	Order No.	Lead-free
60	54477-0608	Yes
80	54477-0808	
100	54477-1008	
120	54477-1208	
150	54477-1508	

Note: Use only one connector per daughterboard in order to insure proper mating alignment

Features and Benefits

- Stacking height: 4.00mm (.157")
- Sizes 60 to 150 circuits
- Polarizing pegs assist placement
- Anti-flux design
- Durable blade-on-beam contact interface

Reference Information

Product Specification: PS-54477-008
Packaging: Embossed tape
Mates With: 55339
Designed In: Millimeters

Electrical

Voltage: 30V max.
Current: 0.3A max.
Contact Resistance: 60 milliohms max.
Dielectric Withstanding Voltage: 250V AC/1 min.
Insulation Resistance: 100 Megohms min.

Physical

Housing: Brown glass-filled LCP, UL 94V-0
Contact: Phosphor Bronze
Plating: Gold over Nickel

0.40mm (.016") Pitch SlimStack™ Board-to-Board Receptacle

54765
SMT, Dual Row, Vertical Stacking

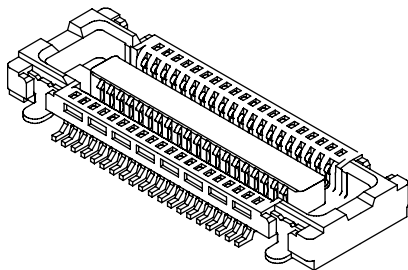

Circuits	Order No.	Lead-free
40	54765-4070	Yes
50	54765-5070	
70	54765-7070	
80	54765-8070	

Features and Benefits

- Stacking height: 1.50mm (.059")
- Housing guide provides mating alignment
- Metal friction lock provides secure mating retention
- High-temperature housing
- Durable blade-on-beam contact interface

Reference Information

Product Specification: PS-54765-012
Packaging: Embossed tape
Mates With: 55604
Designed In: Millimeters

Electrical

Voltage: 50V max.
Current: 0.3A max.
Contact Resistance: 40 milliohms max.
Dielectric Withstanding Voltage: 250V AC/1 min.
Insulation Resistance: 100 Megohms min.

Physical

Housing: Black glass-filled LCP, UL 94V-0
Contact: Phosphor Bronze
Plating: Gold over Nickel
Fitting Nail: Phosphor Bronze, Tin over Nickel plating

0.40mm (.016") Pitch SlimStack™ Board-to-Board Plug

55604
SMT, Dual Row, Vertical Stacking,

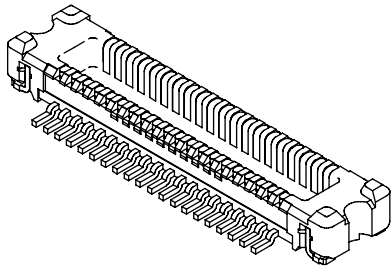

Circuits	Order No.	Lead-free
40	55604-4070	Yes
50	55604-5070	
70	55604-7070	
80	55604-8070	

Features and Benefits

- Stacking height: 1.50mm (.059")
- Housing guide provides mating alignment
- Metal friction lock provides secure mating retention
- High-temperature housing

Reference Information

Product Specification: PS-54765-012
Packaging: Embossed tape
Mates With: 54765
Designed In: Millimeters

Electrical

Voltage: 50V max.
Current: 0.3A max.
Contact Resistance: 40 milliohms max.
Dielectric Withstanding Voltage: 250V AC/1 min.
Insulation Resistance: 100 Megohms min.

Physical

Housing: Black glass-filled LCP, UL 94V-0
Contact: Brass
Plating: Gold over Nickel
Fitting Nail: Phosphor Bronze, Tin over Nickel plating

0.40mm (.016") Pitch SlimStack™ Board-to-Board Plug

55909
SMT, Dual Row, Vertical Stacking

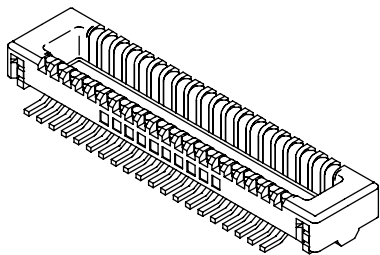

Circuits	Order No.	Lead-free
12	55909-9974	Yes
20	55909-0274	
22	55909-2274	
24	55909-2474	
26	55909-2674	
30	55909-3074	
34	55909-3474	

Features and Benefits

- Stacking Height: 1.50mm with 51338
1.80mm with 500913
- Sizes 12 to 100 circuits
- J-Lead SMT solder tails offer space savings
- Fitting nails provide PCB hold-down and solder joint protection

Reference Information

Product Specification: PS-51338-002 (with 51338)
PS-500913-001 (with 500913)
Packaging: Embossed tape
Mates With: 51338 and 500913
Designed In: Millimeters

Electrical

Voltage: 50V max.
Current: 0.3A max.
Contact Resistance: 40 milliohms max.
Dielectric Withstanding Voltage: 250V AC/1 min.
Insulation Resistance: 100 Megohms min.

Physical

Housing: Black glass-filled LCP, UL 94V-0
Contact: Brass
Plating: Gold over Nickel
Fitting Nail: Phosphor Bronze, Tin over Nickel plating

Circuits	Order No.	Lead-free
40	55909-4074	Yes
50	55909-5074	
60	55909-6074	
70	55909-7074	
80	55909-8074	
90	55909-9074	
100	55909-1074	

0.40mm (.016") Pitch SlimStack™ Board-to-Board Receptacle

51338
SMT, Dual Row
Vertical Stacking

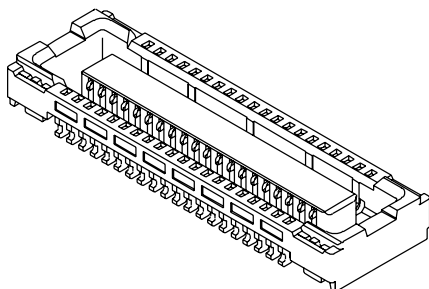

Features and Benefits

- Stacking Height: 1.50mm (.059")
- Sizes 12 to 100 circuits
- J-Lead SMT solder tails offer space savings
- Fitting nails provide PCB hold-down and solder joint

Reference Information

Product Specification: PS-51338-002
Packaging: Embossed tape
Mates With: 55909
Designed In: Millimeters

Electrical

Voltage: 50V max.
Current: 0.3A max.
Contact Resistance: 40 milliohms max.
Dielectric Withstanding Voltage: 250V AC/1 min.
Insulation Resistance: 100 Megohms min.

Physical

Housing: Glass-filled LCP, UL 94V-0
Contact: Phosphor Bronze
Plating: Gold over Nickel
Fitting Nail: Phosphor Bronze, Tin over Nickel plating

Circuits	Order No.	Lead-free
12	51338-9974	Yes
20	51338-0274	
22	51338-2274	
24	51338-2474	
26	51338-2674	
30	51338-0374	
34	51338-3474	

Circuits	Order No.	Lead-free
40	51338-0474	Yes
50	51338-0574	
60	51338-0674	
70	51338-0774	
80	51338-0874	
90	51338-0974	
100	51338-1074	

0.40mm (.016") Pitch SlimStack™ Board-to-Board Receptacle

500913
SMT, Dual Row
Vertical Stacking

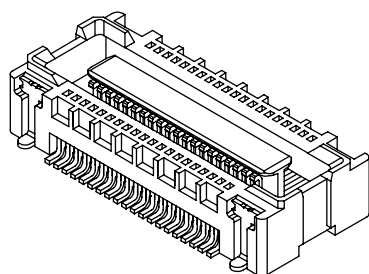

Features and Benefits

- Stacking height: 1.80mm
- Sizes 24 to 100 circuits
- Terminal friction lock provides secure mating retention
- Four fitting nails provide secure PCB hold-down
- Lead-free plating meets environmental requirements

Reference Information

Product Specification: PS-500913-001
Packaging: Embossed tape
Mates With: 55909
Designed In: Millimeters

Electrical

Voltage: 50V max.
Current: 0.3A max.
Contact Resistance: 40 milliohms max.
Dielectric Withstanding Voltage: 250V AC/1 min.
Insulation Resistance: 100 Megohms min.

Physical

Housing: Black glass-filled LCP, UL 94V-0
Contact: Phosphor Bronze
Plating: Gold over Nickel
Fitting Nail: Phosphor Bronze, Tin over Nickel plating

Circuits	Order No.	Lead-free
24	500913-0242	Yes
30	500913-0302	
40	500913-0402	
50	500913-0502	
60	500913-0602	
90	500913-0902	
100	500913-1002	

0.40mm (.016") Pitch Board-to-Board Receptacle

87820
SMT, Dual Row
0.95mm (.037") Height

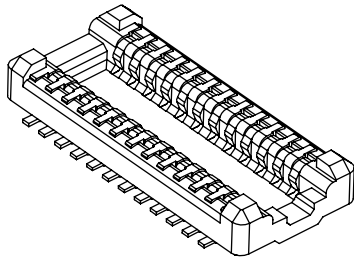

Features and Benefits

- Cantilever-type gold contacts able to withstand severe shock and vibration
- Flat housing area facilitates auto pick-and-place
- High-temperature LCP housing material allows high-temperature SMT soldering processes
- Embossed tape packaging enables pick-and-place assembly
- High-coating on housings provides anti-solder wicking
- Wide-angled mating surface minimizes risk of damage during mating
- Good SMT tail co-planarity assures good solder joints on PCB

Reference Information

Product Specification: PS-87820-028
UL File No.: E29179
CSA File No.: 1699280
Packaging: Embossed tape on reel
Mates With: 87819
Designed In: Millimeters

Electrical

Voltage: 30V
Current: 0.1A
Contact Resistance: 90 milliohms max.
Dielectric Withstanding Voltage: 125V AC
Insulation Resistance: 100 Megohms min.

Mechanical

Contact Retention: 0.5N
Durability: 10 cycles

Physical

Housing: Black LCP, UL 94V-0
Contact: Copper Alloy
Plating: Contact Area—0.1µm (0.4µ") Gold
Solder Tail Area—0.1µm (0.4µ") Gold
Underplating: Nickel

Circuits	Order No.		Lead-free
	Without Solder Tab	With Solder Tab	
14	87820-0014	87820-0514	Yes
24	87820-0024	87820-0524	
30	87820-0030	87820-0530	
40	87820-0040	87820-0540	
50	87820-0050	87820-0550	
60	87820-0060	87820-0560	

www.molex.com/customer.html?seriesNumber=87820

0.40mm (.016") Pitch SlimStack™ Board-to-Board Plug

55526
SMT, Dual Row
Vertical Stacking

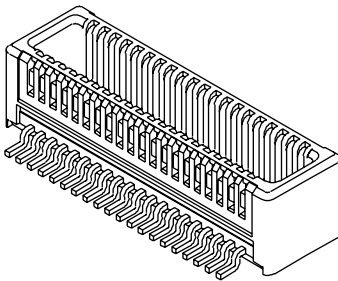

Features and Benefits

- Stacking Height: 3.50mm (.138")
- High-temperature housing
- Double blade-on-beam contact interface

Reference Information

Product Specification: PS-54634-006
Packaging: Embossed tape
Mates With: 54684
Designed In: Millimeters

Electrical

Voltage: 30V max.
Current: 0.3A max.
Contact Resistance: 60 milliohms max.
Dielectric Withstanding Voltage: 250V AC/1 min.
Insulation Resistance: 100 Megohms min.

Physical

Housing: Brown glass-filled LCP, UL 94V-0
Contact: Phosphor Bronze
Plating: Gold over Nickel

Circuits	Order No.	Lead-free
70	55526-0708	Yes
80	55526-0808	
90	55526-0908	
120	55526-1208	

0.40mm (.016") Pitch SlimStack™ Board-to-Board Receptacle

54684
SMT, Dual Row, Vertical Stacking

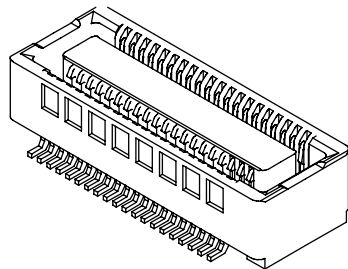

Circuits	Order No.	Lead-free
24	54684-0244	Yes
70	54684-0704	
80	54684-0804	
90	54684-0904	
100	54684-1004	
120	54684-1204	

Features and Benefits

- Stacking height: 3.50mm
- Locking feature provides secure mating
- High-temperature housing
- Durable blade-on-beam contact interface
- Anti-flux design

Reference Information

Product Specification: PS-54684-006
Packaging: Embossed tape
Mates With: 55526
Designed In: Millimeters

Electrical

Voltage: 30V max.
Current: 0.3A max.
Contact Resistance: 60 milliohms max.
Dielectric Withstanding Voltage: 250V AC/1 min.
Insulation Resistance: 100 Megohms min.

Physical

Housing: Brown glass-filled LCP, UL 94V-0
Contact: Phosphor Bronze
Plating: Gold over Nickel

www.molex.com/product/bb/slimstack.html

0.40mm (.016") Pitch Board-to-Board Plug

87819
SMT, Dual Row
0.95mm (.037") Height

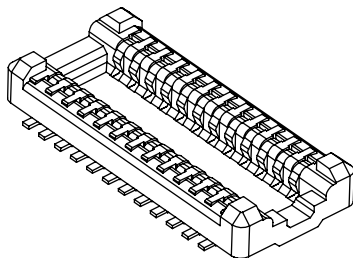

Features and Benefits

- Cantilever-type gold contacts able to withstand severe shock and vibration
- Flat housing area facilitates auto pick-and-place
- High-temperature LCP housing material allows high-temperature SMT soldering processes
- Embossed tape packaging enables pick-and-place assembly
- High-coating on housings provides anti-solder wicking
- Wide-angled mating surface minimizes risk of damage during mating
- Good SMT tail co-planarity assures good solder joints on PCB

Reference Information

Product Specification: PS-87820-028
UL File No.: E29179
CSA File No.: 1699280
Packaging: Embossed tape on reel
Mates With: 87820
Designed In: Millimeters

Electrical

Voltage: 30V
Current: 0.1A
Contact Resistance: 90 milliohms max.
Dielectric Withstanding Voltage: 125V AC
Insulation Resistance: 100 Megohms min.

Mechanical

Contact Retention: 0.5N
Durability: 10 cycles

Physical

Housing: Black LCP, UL 94V-0
Contact: Copper Alloy
Plating: Contact Area—0.1µm (0.4µ") Gold
Solder Tail Area—0.1µm (0.4µ") Gold
Underplating: Nickel

Circuits	Order No.		Lead-free
	Without Solder Tab	With Solder Tab	
14	87819-0014	87819-0514	Yes
24	87819-0024	87819-0524	
30	87819-0030	87819-0530	
40	87819-0040	87819-0540	
50	87819-0050	87819-0550	
60	87819-0060	87819-0560	

0.50mm (.020") Pitch

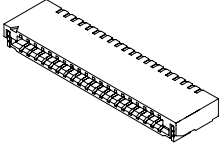
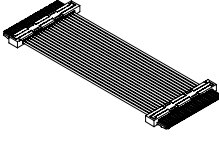
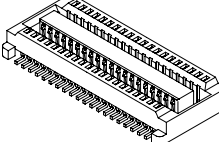
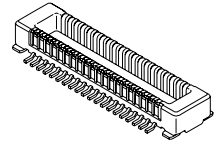
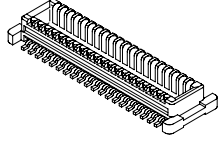
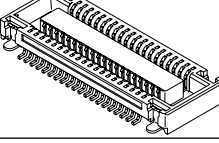
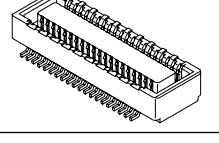
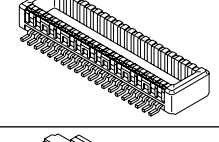
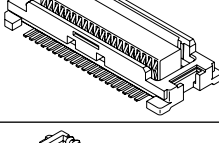
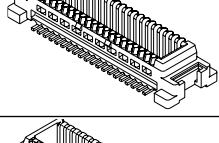
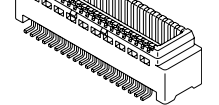
Pitch	Series		Tradename	Description	Stacking Height
0.50mm (.020")	500678			PCB Receptacle, Right Angle	1.20mm (.047")
	59205			Cable Plug Assembly	
	54729		SlimStack™	Receptacle	2.00mm (.079")
	55650			Plug	2.00mm (.079")
	55559			Plug	2.00mm (.079")
	54363			Receptacle	2.00 and 3.00mm (.079 and .118")
	54102			Receptacle	2.50mm (.098")
	53885/500334			Plug	2.50mm (.098")
	52991/54167			Receptacle	3.00 and 4.00mm (.118 and .157")
	53748			Plug	3.00mm (.118")
	53916			Plug	4.00mm (.157")

B
0.40 to 1.60mm (.016 to .063") Pitch PCB and Wire Connectors

0.50mm (.020") Pitch Wire-to-Board PCB Receptacle

500678

SMT, Right Angle

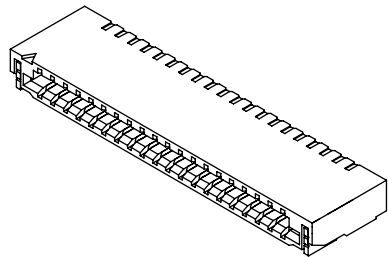

Circuits	Order No.	Lead-free
10	500678-1070	Yes
20	500678-2070	
30	500678-3070	

Features and Benefits

- Compact size provides space savings
- Solder tabs provide secure PCB retention
- Connector-to-connector polarization ensures proper mating
- Friction lock provides secure mating retention

Reference Information

Product Specification: PS-500678-002
 Packaging: Embossed tape
 Mates With: 59205
 Designed In: Millimeters

Electrical

Voltage: 30V max.
 Current: 0.4A max.
 Contact Resistance: 40 milliohms max.
 Dielectric Withstanding Voltage: 200V AC/1 min.
 Insulation Resistance: 100 Megohms min.

Physical

Housing: White heat resistant Polymer, UL 94V-0
 Contact: Copper Alloy
 Plating: Gold over Nickel
 Fitting Nail: Copper Alloy, Tin over Nickel

0.50mm (.020") Pitch Wire-to-Board Plug Harness

59205

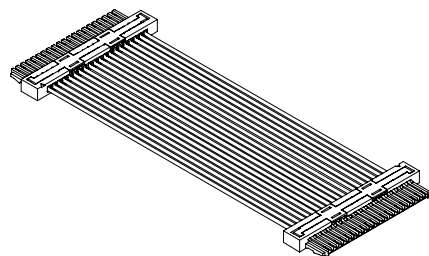

Order No.	Lead-free
59205-99XX	Yes

Note: Contact Molex for ordering numbers and further details.

Features and Benefits

- Friction lock ensures high retention force
- Retainer provides strain relief to solder termination areas

Reference Information

Product Specification: PS-500678-002
 Packaging: Bag
 Mates With: 500678
 Designed In: Millimeters

Electrical

Voltage: 30V max.
 Current: 0.4A max.
 Contact Resistance: 40 milliohms max.
 Dielectric Withstanding Voltage: 200V AC/1 min.
 Insulation Resistance: 100 Megohms min.

0.50mm (.020") Pitch SlimStack™ Board-to-Board Receptacle

54729
SMT, Dual Row, Vertical Stacking

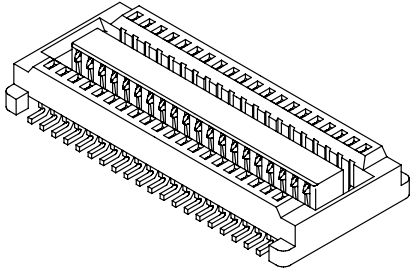

Circuits	Order No.	Lead-free
16	54729-0166	Yes
24	54729-0246	

Features and Benefits

- Stacking height: 2.00mm (.079")
- Locking feature provides secure mating
- Durable blade-on-beam contact interface
- Anti-flux design

Reference Information

Product Specification: PS-54729-013
 Packaging: Embossed tape
 Mates With: 55559
 Designed In: Millimeters

Electrical

Voltage: 50V max.
 Current: 0.5A max.
 Contact Resistance: 30 milliohms max.
 Dielectric Withstanding Voltage: 500V AC/1 min.
 Insulation Resistance: 500 Megohms min.

Physical

Housing: Black glass-filled LCP, UL 94V-0
 Contact: Phosphor Bronze
 Plating: Gold over Nickel

0.50mm (.020") Pitch SlimStack™ Board-to-Board Plug

55650
SMT, Dual Row
Vertical Stacking

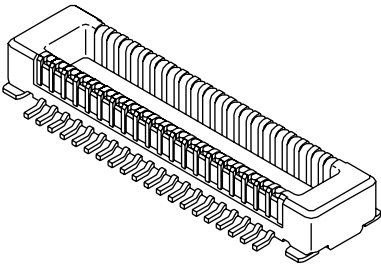

Circuits	Order No.	Lead-free
20	55650-0288	Yes
30	55650-0388	
40	55650-0488	
50	55650-0588	
60	55650-0688	
70	55650-0788	

Features and Benefits

- Stacking Height: 2.00mm (.079")
- Sizes 20 to 70 circuits
- Fitting nails provide PCB hold-down and solder joint
- Anti-flux design

Reference Information

Product Specification: PS-54363-046
 Packaging: Embossed tape
 Mates With: 54363
 Designed In: Millimeters

Electrical

Voltage: 50V max.
 Current: 0.5A max.
 Contact Resistance: 40 milliohms max.
 Dielectric Withstanding Voltage: 125V AC/1 min.
 Insulation Resistance: 100 Megohms min.

Physical

Housing: Black glass-filled LCP, UL 94V-0
 Contact: Copper Alloy
 Plating: Gold over Nickel
 Fitting Nail: Copper Alloy, Tin over Nickel plating

0.50mm (.020") Pitch SlimStack™ Board-to-Board Receptacle

54363
SMT, Dual Row
Vertical Stacking

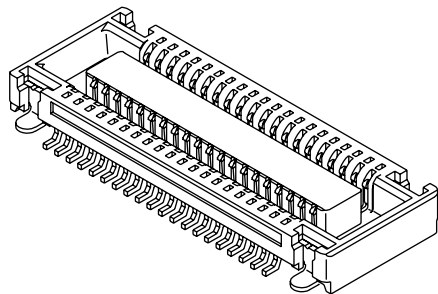

Circuits	Order No.	Lead-free
20	54363-0289	Yes
30	54363-0389	
40	54363-0489	
50	54363-0589	
60	54363-0689	
70	54363-0778	

Note: Use only one connector per daughterboard in order to insure proper mating alignment

Features and Benefits

- Stacking height: 2.00mm (.079")
- Sizes 20 to 70 circuits
- Locking feature provides secure mating
- Fitting nails provide PCB hold-down and strain relief for SMT tails
- Durable blade on beam contact interface
- Anti-flux design

Reference Information

Product Specification: PS-54363-046
Packaging: Embossed tape
Mates With: 55650
Designed In: Millimeters

Electrical

Voltage: 50V max.
Current: 0.5A* max.
Contact Resistance: 40 milliohms max.
Dielectric Withstanding Voltage: 125V AC/1 min.
Insulation Resistance: 100 Megohms min.

Physical

Housing: Black glass-filled LCP, UL 94V-0
Contact: Copper Alloy
Plating: Gold over Nickel
Fitting Nail: Copper Alloy, Tin over Nickel plating
* Total current must not exceed 10A max.

0.50mm (.020") Pitch SlimStack™ Board-to-Board Plug

55559
SMT, Dual Row, Vertical Stacking

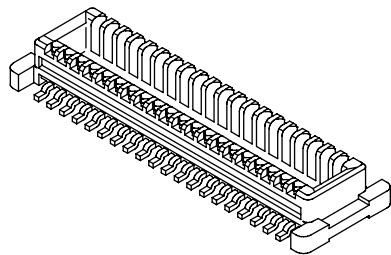

Circuits	Order No.	Lead-free
16	55559-0168	Yes
24	55559-0248	

Features and Benefits

- Stacking height: 2.00mm
- Metal friction lock provides secure mating
- Durable blade-on-beam contact interface
- Anti-flux design

Reference Information

Product Specification: PS-54729-013
Packaging: Embossed tape
Mates With: 54729
Designed In: Millimeters

Electrical

Voltage: 50V max.
Current: 0.5A max.
Contact Resistance: 30 milliohms max.
Dielectric Withstanding Voltage: 500V AC/1 min.
Insulation Resistance: 500 Megohms min.

Physical

Housing: Black glass-filled LCP, UL 94V-0
Contact: Brass
Plating: Gold over Nickel

0.50mm (.020") Pitch SlimStack™ Board-to-Board Plug

53885/500334
SMT, Dual Row
Vertical Stacking

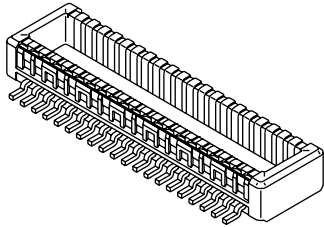

Features and Benefits

- Stacking height: 2.50mm (.098")
- Sizes 16 to 70 circuits
- Locking feature provides secure mating
- Durable blade on beam contact interface
- Anti-flux design

Reference Information

Product Specification: PS-54102-001 (53885)
PS-54102-010 (500334)

Packaging: Embossed tape
Mates With: 54102
Designed In: Millimeters

Electrical

Voltage: 50V max.
Current: 0.5A max.
Contact Resistance: 40 milliohms max.
Dielectric Withstanding Voltage: 500V AC/1 min.
Insulation Resistance: 100 Megohms min.

Physical

Housing: Black glass-filled LCP, UL 94V-0
Contact: Brass
Plating: Gold over Nickel

Circuits	Order No.	Lock Position	Lead-free
16	500334-0160	All	Yes
20	500334-0201		
30	500334-0300		
40	53885-0408	3, 6, 9, 12, 15, 18	
50	53885-0508	4, 10, 16, 22	
60	53885-0608	10, 21	
70	53885-0708	None	

Note: Use only one connector per daughterboard in order to insure proper mating alignment

0.50mm (.020") Pitch SlimStack™ Board-to-Board Receptacle

54102
SMT, Dual Row
Vertical Stacking

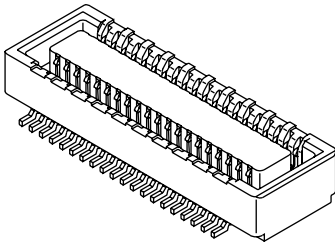

Features and Benefits

- Stacking height: 2.50mm (.098")
- Sizes 16 to 70 circuits
- Locking feature provides secure mating
- Durable blade on beam contact interface
- Anti-flux design

Reference Information

Product Specification: PS-54102-011 (with 53885)
PS-54102-010 (with 500334)

Packaging: Embossed tape
Mates With: 53885 and 500334
Designed In: Millimeters

Electrical

Voltage: 50V max.
Current: 0.5A max.
Contact Resistance: 40 milliohms max.
Dielectric Withstanding Voltage: 500V AC/1 min.
Insulation Resistance: 100 Megohms min.

Physical

Housing: Black glass-filled PPA, UL 94V-0
Contact: Phosphor Bronze
Plating: Gold over Nickel

Circuits	Order No.	Lead-free
16	54102-0164	Yes
20	54102-0204	
30	54102-0304	
40	54102-0404	
50	54102-0504	
70	54102-0704	

Note: Use only one connector per daughterboard in order to insure proper mating alignment

0.50mm (.020") Pitch SlimStack™ Board-to-Board Plug

53748
SMT, Dual Row
Vertical Stacking

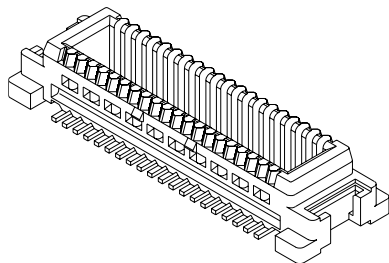

Circuits	Order No.	Lead-free
20	53748-0208	Yes
30	53748-0308	
40	53748-0408	
60	53748-0608	
70	53748-0708	
80	53748-0808	

Note: Use only one connector per daughterboard in order to insure proper mating alignment

Features and Benefits

- Stacking height: 3.0mm
- Sizes 20 to 80 circuits
- Locking feature provides secure mating
- High temperature housing
- Durable blade on beam contact interface
- Anti-flux design

Reference Information

Product Specification: PS-52991-003
Packaging: Embossed tape
Mates With: 52991/54167
Designed In: Millimeters

Electrical

Voltage: 50V max.
Current: 0.5A max.
Contact Resistance: 50 milliohms max.
Dielectric Withstanding Voltage: 500V AC/1 min.
Insulation Resistance: 100 Megohms min.

Physical

Housing: White glass-filled LCP, UL 94V-0
Contact: Brass
Plating: Gold over Nickel

0.50mm (.020") Pitch SlimStack™ Board-to-Board Receptacle

52991/54167
SMT, Dual Row
Vertical Stacking

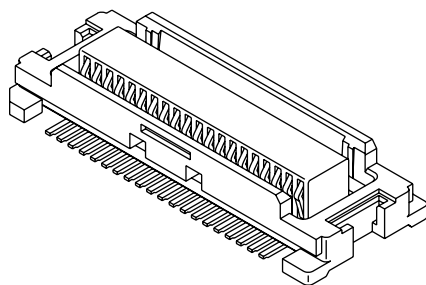

Features and Benefits

- Stacking Heights: 3.0 and 4.0mm
- Sizes 20 to 80 circuits
- Locking feature provides secure mating
- High temperature housing
- Durable blade on beam contact interface
- Anti-flux design

Reference Information

Product Specification: PS-52991-003 (with 53748)
PS-54167-002 (with 53916)
Packaging: Embossed tape
Mates With: 53748 (H = 3.0mm)
53916 (H = 4.0mm)
Designed In: Millimeters

Electrical

Voltage: 50V max.
Current: 0.5A max.
Contact Resistance: 53748—50 milliohms max.
53916—60 milliohms max.
Dielectric Withstanding Voltage: 500V AC/1 min.
Insulation Resistance: 100 Megohms min.

Physical

Housing: Glass-filled LCP, UL 94V-0
Contact: Phosphor Bronze
Plating: Gold over Nickel

Circuits	Order No.		Lead-free
	White	Black	
20	52991-0208	54167-0208	Yes
30	52991-0308	54167-0308	
40	52991-0408	54167-0408	
50	52991-0508	54167-0508	
60	52991-0608	54167-0608	
70	52991-0708		
80	52991-0808	54167-0808	

Note: Use only one connector per daughterboard in order to insure proper mating alignment

0.50mm (.020") Pitch SlimStack™ Board-to-Board Plug

53916
SMT, Dual Row
Vertical Stacking

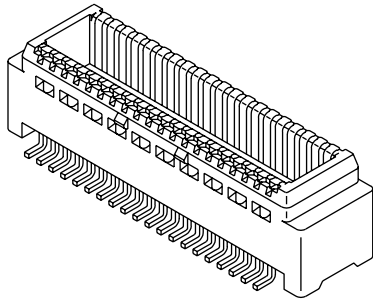

Features and Benefits

- Stacking height: 4.0mm
- Locking feature provides secure mating
- High temperature housing
- Durable blade on beam contact interface
- Anti-flux design

Reference Information

Product Specification: PS-54167-002
Packaging: Embossed tape
Mates With: 52991, 54167
Designed In: Millimeters

Electrical

Voltage: 50V max.
Current: 0.5A max.
Contact Resistance: 60 milliohms max.
Dielectric Withstanding Voltage: 500V AC/1 min.
Insulation Resistance: 100 Megohms min.

Physical

Housing: Black glass-filled LCP, UL 94V-0
Contact: Brass
Plating: Gold over Nickel

Circuits	Order No.	Lead-free
20	53916-0208	Yes

Note: Use only one connector per daughterboard in order to insure proper mating alignment

0.635mm (.025") and 0.80mm (.031") Pitch

B

0.40 to 1.60mm (.016 to .063") Pitch PCB and Wire Connectors

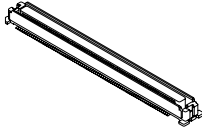
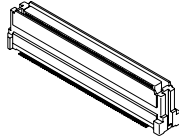
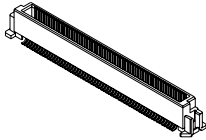
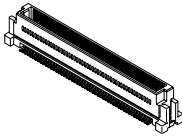
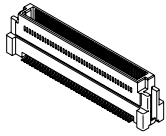
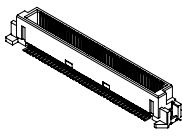
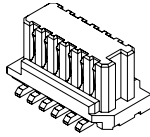
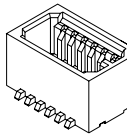
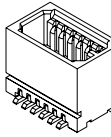
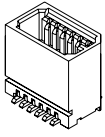
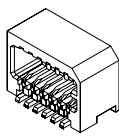
Pitch	Series		Tradename	Description	Stacking Height
0.635mm (.025")	52760/52885		SlimStack™	Receptacle	5.00 and 10.00mm (.197 and .394")
	52837/52901			Receptacle	11.00 and 16.00mm (.433 and .630")
	53481/53625			Plug	7.00 and 13.00mm (.276 and .512")
	53551/53647			Plug	8.00 and 14.00mm (.315 and .551")
	53553/53627			Plug	10.00 and 16.00mm (.394 and .630")
	55091			Header	6.00 and 12.00mm (.236 and .472")
0.80mm (.031")	52465			Receptacle	4.50, 6.00 and 7.00mm (.177, .236 and .276")
	53307			Header	4.50 and 5.50mm (.177 and .217")
	53364			Header	6.00 and 7.00mm (.236 and .276")
	53353			Header	7.00 and 8.00mm (.276 and .315")
	53309			Header, Right Angle	5.65 and 6.65mm (.222 and .262")

0.635mm (.025") Pitch SlimStack™ Board-to-Board Receptacle

52885
SMT, Dual Row
Vertical Stacking

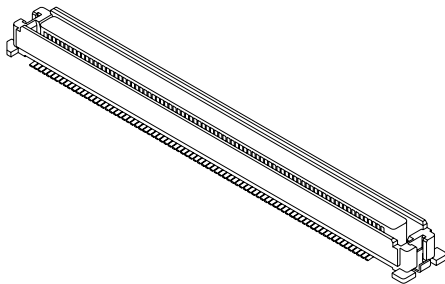

Features and Benefits

- Stacking height: 6.0 to 10mm
- Sizes 20 to 240 circuits
- Housing lock on 20 to 70 circuits
- Anti-flux design
- Fitting nails provide PCB hold down and strain relief for SMT tails
- Polarizing pegs assist placement

Reference Information

Product Specification: PS-52760-015
 Packaging: Embossed tape
 Mates With: 55091 (H = 6.0mm)
 53625 (H = 7.0mm)
 53647 (H = 8.0mm)
 53627 (H = 10.0mm)
 Designed In: Millimeters

Electrical

Voltage: 100V max.
 Current: 0.5A max.
 Contact Resistance:
 40 milliohms max. (H=6.0, 7.0mm)
 50 milliohms max. (H=8.0, 10.0mm)
 Dielectric Withstanding Voltage: 250V AC/1 min.
 Insulation Resistance: 1000 Megohms min.

Physical

Housing: White glass-filled LCP, UL 94V-0
 Contact: Copper Alloy
 Plating: Contact Area—Gold over Nickel
 Solder Tail Area—Tin over Nickel
 Fitting Nail: Copper Alloy, Tin over Nickel plating

Circuits	Order No.	Lead-free
20	52885-0274	Yes
30	52885-0374	
40	52885-0474	
50	52885-0574	
60	52885-0674	
70	52885-0774	
80	52885-0874	

Circuits	Order No.	Lead-free
90	52885-0974	Yes
100	52885-1074	
120	52885-1274	
140	52885-1474	
160	52885-1674	
240	52885-2474	

Note: Use only one connector per daughterboard in order to insure proper mating alignment

0.635mm (.025") Pitch SlimStack™ Board-to-Board Plug

53625
SMT, Dual Row
Vertical Stacking

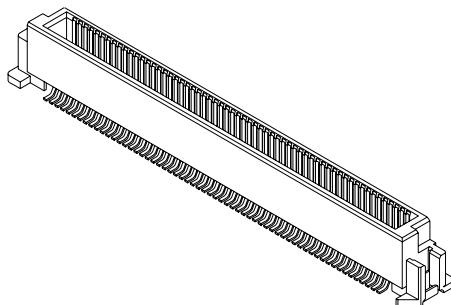

Features and Benefits

- Stacking height: 7.0 and 13.0mm
- Sizes 30 to 240 circuits
- Housing lock on 20 to 70 circuits
- Anti-flux design
- Fitting nails provide PCB hold down and strain relief for SMT tails
- Polarizing pegs assist placement

Reference Information

Product Specification: PS-52760-015
 Packaging: Embossed tape
 Mates With: 52885 (H = 7.0mm)
 52901 (H = 13.0mm)
 Designed In: Millimeters

Electrical

Voltage: 100V max.
 Current: 0.5A max.
 Contact Resistance: 40 milliohms max. (H=7.0mm)
 60 milliohms max. (H=13.0mm)
 Dielectric Withstanding Voltage: 250V AC/1 min.
 Insulation Resistance: 1000 Megohms min.

Physical

Housing: Brown glass-filled LCP, UL 94V-0
 Contact: Copper Alloy
 Plating: Contact Area—Gold over Nickel
 Solder Tail Area—Tin over Nickel
 Fitting Nail: Copper Alloy, Tin over Nickel plating

Circuits	Order No.	Lead-free
30	53625-0374	Yes
40	53625-0474	
50	53625-0574	
80	53625-0874	
90	53625-0974	

Circuits	Order No.	Lead-free
120	53625-1274	Yes
140	53625-1474	
160	53625-1674	
240	53625-2474	

Note: Use only one connector per daughterboard in order to insure proper mating alignment

0.635mm (.025") Pitch SlimStack™ Board-to-Board Receptacle

52901
SMT, Dual Row
Vertical Stacking

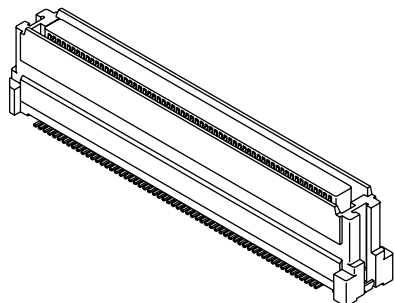

Features and Benefits

- Stacking height: 12.0 to 16.0mm
- Sizes 20 to 140 circuits
- Housing lock on 20 to 70 circuits
- Anti-flux design
- Fitting nails provide PCB hold down and strain relief for SMT tails
- Polarizing pegs assist placement

Reference Information

Product Specification: PS-52760-015
 Packaging: Embossed tape
 Mates With: 55091 (H = 12.0mm)
 53625 (H = 13.0mm)
 53647 (H = 14.0mm)
 53627 (H = 16.0mm)
 Designed In: Millimeters

Electrical

Voltage: 100V max.
 Current: 0.5A max.
 Contact Resistance:
 60 milliohms max. (H=12.0, 13.0mm)
 70 milliohms max. (H=14.0, 16.0mm)
 Dielectric Withstanding Voltage: 250V AC/1 min.
 Insulation Resistance: 1000 Megohms min.

Physical

Housing: White glass-filled LCP, UL 94V-0
 Contact: Copper Alloy
 Plating: Contact Area—Gold over Nickel
 Solder Tail Area—Tin over Nickel
 Fitting Nail: Copper Alloy, Tin over Nickel plating

Circuits	Order No.	Lead-free
20	52901-0274	Yes
30	52901-0374	
40	52901-0474	
60	52901-0674	
70	52901-0774	

Circuits	Order No.	Lead-free
80	52901-0874	Yes
90	52901-0974	
100	52901-1074	
120	52901-1274	
140	52901-1474	
140	52901-1474	

Note: Use only one connector per daughterboard in order to insure proper mating alignment

0.635mm (.025") Pitch SlimStack™ Board-to-Board Plug

53647
SMT, Dual Row
Vertical Stacking

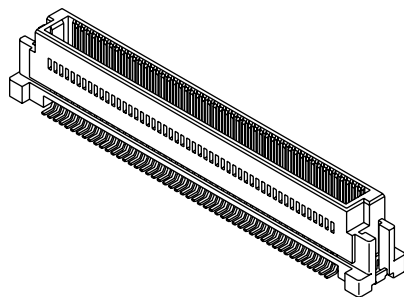

Features and Benefits

- Stacking height: 8.0 and 14.0mm
- Sizes 20 to 160 circuits
- Housing lock on 20 to 40 circuits
- Anti-flux design
- Fitting nails provide PCB hold down and strain relief for SMT tails
- Polarizing pegs assist placement

Reference Information

Product Specification: PS-52760-015
 Packaging: Embossed tape
 Mates With: 52885 (H = 8.0mm)
 52901 (H = 14.0mm)
 Designed In: Millimeters

Electrical

Voltage: 100V max.
 Current: 0.5A max.
 Contact Resistance: 50 milliohms max. (H=8.0mm)
 70 milliohms max. (H=14.0mm)
 Dielectric Withstanding Voltage: 250V AC/1 min.
 Insulation Resistance: 1000 Megohms min.

Physical

Housing: Brown glass-filled PPS, UL 94V-0
 Contact: Copper Alloy
 Plating: Contact Area—Gold over Nickel
 Solder Tail Area—Tin over Nickel

Circuits	Order No.	Lead-free
20	53647-0274	Yes
30	53647-0374	
40	53647-0474	
60	53647-0674	
80	53647-0874	
80	53647-0874	

Circuits	Order No.	Lead-free
100	53647-1074	Yes
120	53647-1274	
140	53647-1474	
140	53647-1674	
160	53647-1674	

Note: Use only one connector per daughterboard in order to insure proper mating alignment

0.635mm (.025") Pitch SlimStack™ Board-to-Board Plug

53627
SMT, Dual Row
Vertical Stacking

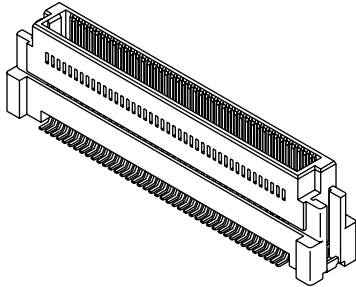

Features and Benefits

- Stacking height: 10.0 and 16.0mm
- Sizes 20 to 140 circuits
- Housing lock on 20 to 70 circuits
- Anti-flux design
- Fitting nails provide PCB hold down and strain relief for SMT tails
- Polarizing pegs assist placement

Reference Information

Product Specification: PS-52760-015
Packaging: Embossed tape
Mates With: 52885 (H = 10.0mm)
52901 (H = 16.0mm)
Designed In: Millimeters

Electrical

Voltage: 100V max.
Current: 0.5A max.
Contact Resistance: 50 milliohms max. (H=10.0mm)
70 milliohms max. (H=16.0mm)
Dielectric Withstanding Voltage: 250V AC/1 min.
Insulation Resistance: 1000 Megohms min.

Physical

Housing: Brown glass-filled PPS, UL 94V-0
Contact: Copper Alloy
Plating: Contact Area—Gold over Nickel
Solder Tail Area—Tin over Nickel
Fitting Nail: Phosphor Bronze, Tin over Nickel plating

Circuits	Order No.	Lead-free
20	53627-0274	Yes
30	53627-0374	
40	53627-0474	
50	53627-0574	
60	53627-0674	
70	53627-0774	

Circuits	Order No.	Lead-free
80	53627-0874	Yes
90	53627-0974	
100	53627-1074	
120	53627-1274	
140	53627-1474	

Note: Use only one connector per daughterboard in order to insure proper mating alignment

0.635mm (.025") Pitch SlimStack™ Board-to-Board Plug

55091
SMT, Dual Row, Vertical Stacking

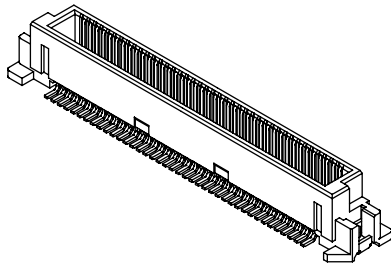

Features and Benefits

- Stacking heights of 6.00 and 12.00mm (.236 and .472")
- Sizes 20 to 160 circuits
- Housing lock on 20 to 70 circuits
- Anti-flux design
- Fitting nails provide PCB hold-down and strain relief for SMT tails
- Polarizing pegs assist placement onto PCB

Reference Information

Product Specification: PS-52760-015
Packaging: Embossed tape
Mates With: 52885 (H = 6.0mm)
52901 (H = 12.0mm)
Designed In: Millimeters

Electrical

Voltage: 100V max.
Current: 0.5A max.
Contact Resistance: 40 milliohms max., 60 milliohms max.
Dielectric Withstanding Voltage: 250V AC/1 min.
Insulation Resistance: 1000 Megohms min.

Physical

Housing: Black glass-filled LCP, UL 94V-0
Contact: Copper Alloy
Plating: Contact Area—Gold over Nickel
Solder Tail Area—Tin over Nickel
Fitting Nail: Copper Alloy, Tin over Nickel plating

Circuits	Order No.	Lead-free
20	55091-0274	Yes
30	55091-0374	
40	55091-0474	
50	55091-0574	
60	55091-0674	
70	55091-0774	

Circuits	Order No.	Lead-free
80	55091-0874	Yes
90	55091-0974	
100	55091-1074	
120	55091-1274	
140	55091-1474	
160	55091-1674	

0.80mm (.031") Pitch Board-to-Board Receptacle

52465 Dual Row SMT

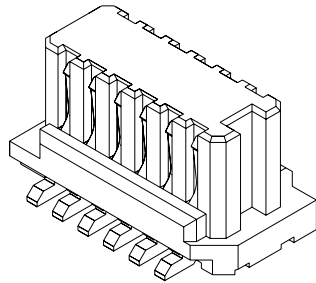

Features and Benefits

- Stacking Heights: 4.5 to 7.0mm (5.65mm right angle mated height)
- Sizes 10 to 40 circuits

Reference Information

Product Specification: PS-52465-015 (with 53307)
 PS-52465-010 (with 53364, 53353)
 PS-52465-014 (with 53309)

Packaging: Embossed tape
 Mates With: 53307 (H = 4.5mm)
 53309 (H = 5.65mm)
 53364 (H = 6.0mm)
 53353 (H = 7.0mm)

Designed In: Millimeters

Electrical

Voltage: 50V max.
 Current: 0.5A max.
 Contact Resistance: 20 milliohms max.
 Dielectric Withstanding Voltage: 500V AC/1 min.
 Insulation Resistance: 100 Megohms min.

Physical

Housing: PPA, UL 94V-0
 Contact: Phosphor Bronze
 Plating: Tin over Nickel

Circuits	Order No.	Lead-free
10	52465-1071	Yes
12	52465-1271	
14	52465-1471	
16	52465-1671	
18	52465-1871	
20	52465-2071	
22	52465-2271	
24	52465-2471	

Circuits	Order No.	Lead-free
26	52465-2671	Yes
28	52465-2871	
30	52465-3071	
32	52465-3271	
34	52465-3471	
36	52465-3671	
40	52465-4071	

www.molex.com/customer.html?seriesNumber=52465

0.80mm (.031") Pitch Board-to-Board Plug

53307 SMT, Dual Row Vertical Stacking

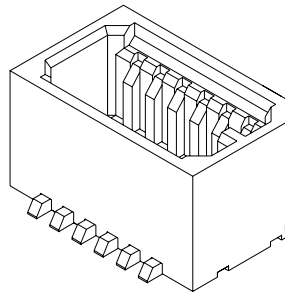

Features and Benefits

- Stacking height: 4.5mm
- Sizes 10 to 40 circuits

Reference Information

Product Specification: PS-52465-015
 Packaging: Embossed tape
 Mates With: 52465
 Designed In: Millimeters

Electrical

Voltage: 50V max.
 Current: 0.5A max.
 Contact Resistance: 20 milliohms max.
 Dielectric Withstanding Voltage: 500V AC/1 min.
 Insulation Resistance: 100 Megohms min.

Physical

Housing: PPS, UL 94V-0
 Contact: Phosphor Bronze
 Plating: Tin over Nickel

Circuits	Order No.	Lead-free
10	53307-1071	Yes
12	53307-1271	
14	53307-1471	
16	53307-1671	
18	53307-1871	
20	53307-2071	

Circuits	Order No.	Lead-free
24	53307-2471	Yes
26	53307-2671	
28	53307-2871	
30	53307-3071	
36	53307-3671	
40	53307-4071	

0.80mm (.031") Pitch Board-to-Board Plug

53364
SMT, Dual Row
Vertical Stacking

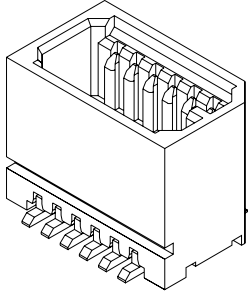

Features and Benefits

- Stacking height: 6.0mm
- Sizes 18 to 36 circuits

Reference Information

Product Specification: PS-52465-010
Packaging: Embossed tape
Mates With: 52465
Designed In: Millimeters

Electrical

Voltage: 50V max.
Current: 0.5A max.
Contact Resistance: 20 milliohms max.
Dielectric Withstanding Voltage: 500V AC/1 min.
Insulation Resistance: 100 Megohms min.

Physical

Housing: PPS, UL 94V-0
Contact: Phosphor Bronze
Plating: Tin over Nickel

Circuits	Order No.	Lead-free
18	53364-1871	Yes
20	53364-2071	
30	53364-3071	
36	53364-3671	

www.molex.com/customer.html?seriesNumber=53364

0.80mm (.031") Pitch Board-to-Board Plug

53309
SMT, Dual Row
Right Angle

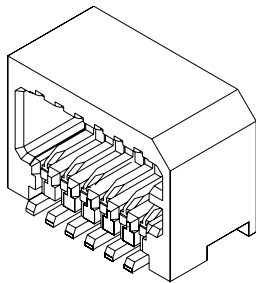

Features and Benefits

- Mated height: 5.65mm
- Sizes 10 to 40 circuits

Reference Information

Product Specification: PS-52465-014
Packaging: Embossed tape
Mates With: 52465
Designed In: Millimeters

Electrical

Voltage: 50V max.
Current: 0.5A max.
Contact Resistance: 20 milliohms max.
Dielectric Withstanding Voltage: 500V AC/1 min.
Insulation Resistance: 100 Megohms min.

Physical

Housing: PPS, UL 94V-0
Contact: Phosphor Bronze
Plating: Tin over Nickel

Circuits	Order No.	Lead-free
10	53309-1070	Yes
12	53309-1270	
14	53309-1470	
16	53309-1670	
18	53309-1870	
20	53309-2070	
22	53309-2270	
24	53309-2470	

Circuits	Order No.	Lead-free
26	53309-2670	Yes
28	53309-2870	
30	53309-3070	
32	53309-3270	
34	53309-3470	
36	53309-3670	
40	53309-4070	

0.80mm (.031") Pitch Board-to-Board Plug

53353

**SMT, Dual Row
Vertical Stacking**

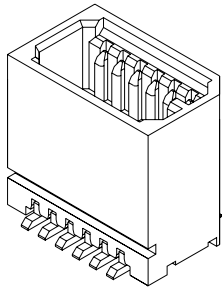

Circuits	Order No.	Lead-free
10	53353-1071	Yes
16	53353-1671	
18	53353-1871	
20	53353-2071	
28	53353-2871	
30	53353-3071	

Features and Benefits

- Stacking height: 7.0mm
- Sizes 10 to 30 circuits

Reference Information

Product Specification: PS-52465-010
 Packaging: Embossed tape
 Mates With: 52465
 Designed In: Millimeters

Electrical

Voltage: 50V max.
 Current: 0.5A max.
 Contact Resistance: 20 milliohms max.
 Dielectric Withstanding Voltage: 500V AC/1 min.
 Insulation Resistance: 100 Megohms min.

Physical

Housing: PPS, UL 94V-0
 Contact: Phosphor Bronze
 Plating: Tin

1.00mm (.039") Pitch

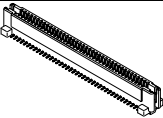
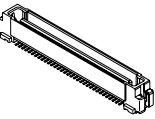
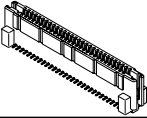
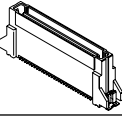
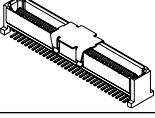
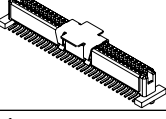
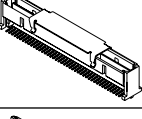
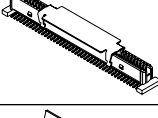
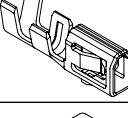
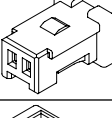
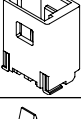
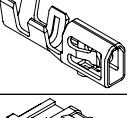
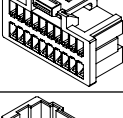
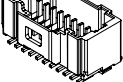
Pitch	Series		Tradename	Description
1.00mm (.039")	52584		SlimStack™	Receptacle
	53395			Plug
	52602			Receptacle
	53408			Plug
	71436		Mezzanine IEEE 1386	Plug
	71439			Receptacle
	71741		Mezzanine	Plug
	71742			Receptacle
	501334		Pico-Clasp™	Crimp Terminal
	501330			Housing
	501331			Header
	501193			Crimp Terminal
	501189			Housing
	501190			Header

B
0.40 to 1.60mm (.016 to .063") Pitch PCB and Wire Connectors

1.00mm (.039") Pitch SlimStack™ Board-to-Board Receptacle

52584
SMT, Dual Row
Vertical Stacking

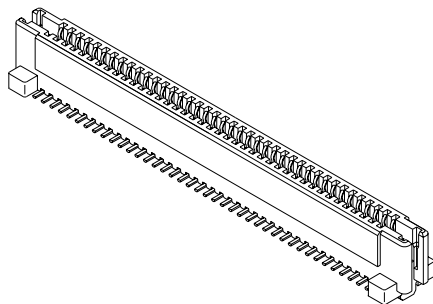

- Features and Benefits**
- Stacking heights: 8.0 and 18.0mm
 - Sizes 20 to 140 circuits
 - Leaf-style design protects pins
 - Anti-flux design
 - Low insertion force
 - Polarization pegs assist placement

Reference Information
Product Specification: PS-52584-003
Packaging: Tube
Mates With: 53395 (H = 8.0mm)
53408 (H = 18.0mm)
Designed In: Millimeters

Electrical
Voltage: 100V max.
Current: 0.5A max.
Contact Resistance:
40 milliohms max. (H=8.0mm)
70 milliohms max. (H=18.0mm)
Dielectric Withstanding Voltage: 200V AC/1 min.
Insulation Resistance: 1000 Megohms min.

Physical
Housing: White glass-filled LCP, UL 94V-0
Contact: Phosphor Bronze
Plating: Contact Area—Gold over Nickel
Solder Tail Area—Tin over Nickel

Circuits	Order No.	Lead-free
20	52584-0279	Yes
34	52584-3479	
50	52584-0579	
60	52584-0679	
66	52584-6679	

Circuits	Order No.	Lead-free
80	52584-0879	Yes
100	52584-1079	
120	52584-1279	
140	52584-1479	

Note: Use only one connector per daughterboard in order to insure proper mating alignment

1.00mm (.039") Pitch SlimStack™ Board-to-Board Receptacle

52602
SMT, Dual Row
Vertical Stacking

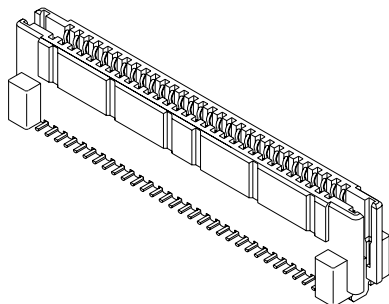

- Features and Benefits**
- Stacking heights: 20.0mm
 - Sizes 50 to 120 circuits
 - Leaf-style design protects pins
 - Anti-flux design
 - Low insertion force
 - Polarization pegs assist placement

Reference Information
Product Specification: PS-52584-003
Packaging: Tube
Mates With: 53408
Designed In: Millimeters

Electrical
Voltage: 100V max.
Current: 0.5A max.
Contact Resistance: 70 milliohms max.
Dielectric Withstanding Voltage: 200V AC/1 min.
Insulation Resistance: 1000 Megohms min.

Physical
Housing: White glass-filled LCP, UL 94V-0
Contact: Phosphor Bronze
Plating: Contact Area—Gold over Nickel
Solder Tail Area—Tin over Nickel

Circuits	Order No.	Lead-free
50	52602-0579	Yes
60	52602-0679	
120	52602-1279	

Note: Use only one connector per daughterboard in order to insure proper mating alignment

1.00mm (.039") Pitch SlimStack™ Board-to-Board Plug

53395
SMT, Dual Row
Vertical Stacking

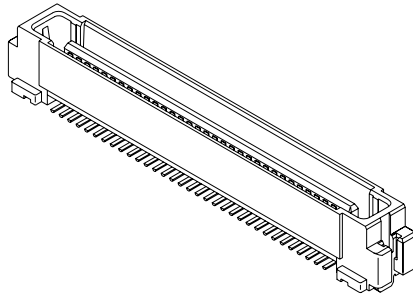

Features and Benefits

- Stacking heights: 8.0mm
- Sizes 20 to 140 circuits
- Leaf-style design protects pins
- Anti-flux design
- Low insertion force
- Polarization pegs assist placement

Reference Information

Product Specification: PS-52584-003
Packaging: Tube
Mates With: 52584
Designed In: Millimeters

Electrical

Voltage: 100V max.
Current: 0.5A max.
Contact Resistance: 40 milliohms max.
Dielectric Withstanding Voltage: 200V AC/1 min.
Insulation Resistance: 1000 Megohms min.

Physical

Housing: White glass-filled LCP, UL 94V-0
Contact: Phosphor Bronze
Plating: Contact Area—Gold over Nickel
Solder Tail Area—Tin over Nickel

Circuits	Order No.	Lead-free
20	53395-0279	Yes
34	53395-3479	
66	53395-6679	
100	53395-1079	
140	53395-1479	

Note: Contact Molex for embossed tape specifications
Note: Use only one connector per daughterboard in order to insure proper mating alignment

1.00mm (.039") Pitch SlimStack™ Board-to-Board Plug

53408
SMT, Dual Row
Vertical Stacking

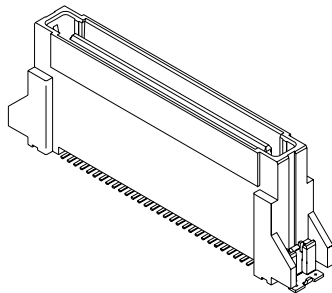

Features and Benefits

- Stacking heights: 18.0, 20.0mm
- Sizes 50 to 140 circuits
- Leaf-style design protects pins
- Antiflux design
- Low insertion force
- Polarization pegs assist placement

Reference Information

Product Specification: PS-52584-003
Packaging: Tube
Mates With: 52584 (H = 18.0mm)
52602 (H = 20.0mm)
Designed In: Millimeters

Electrical

Voltage: 100V max.
Current: 0.5A max.
Contact Resistance: 70 milliohms max.
Dielectric Withstanding Voltage: 200V AC/1 min.
Insulation Resistance: 1000 Megohms min.

Physical

Housing: White glass-filled LCP, UL 94V-0
Contact: Phosphor Bronze
Plating: Contact Area—Gold over Nickel
Solder Tail Area—Tin over Nickel

Circuits	Order No.	Lead-free
50	53408-0579	Yes
60	53408-0679	
80	53408-0879	
100	53408-1079	
120	53408-1279	
140	53408-1479	

Note: Contact Molex for embossed tape specifications
Note: Use only one connector per daughterboard in order to insure proper mating alignment

1.00mm (.039") Pitch Mezzanine IEEE 1386 SMT Stacking Board-to-Board Connectors

The IEEE 1386 Standard contains the details for adding standardized general option, PCI and other mezzanine cards to VMEbus and compact PCI and other types of host boards. There are also many networking, telecommunications, PC and workstation users who want a standardized mezzanine scheme and see the IEEE 1386 as the best approach.

Molex's fully-shrouded leaf-style design minimizes the chance of damaging plug contacts, and our receptacle contacts feature a low mating force, reducing PC board stress. Gold-over-Nickel contact plating enhances long-term reliability and UL 94V-0 LCP housings withstand SMT reflow processes. Excellent tolerance absorption allows the connector to be used in combinations of 1-4 mated pairs for up to 256 circuits.

As the need for faster signal speeds increases, the need for better performance and signal integrity performance of connectors also increases. The 1.00mm (.039") mezzanine connectors from Molex provide the excellent performance required by today's high-speed systems. For example, Molex 1.00mm (.039") mezzanine connectors can be used in a 5.0 Gbps application by using grounds between each differential pair (G-S-S-G), resulting in a differential impedance of 100 ohms \pm 10% and 2.23% NEXT at a 50psec (10/90%) risetime. At -3dB, the insertion loss for the Molex 1.00mm (.039") mezzanine connectors is 7.3GHz. At -10dB, the differential return loss is 6.2GHz.

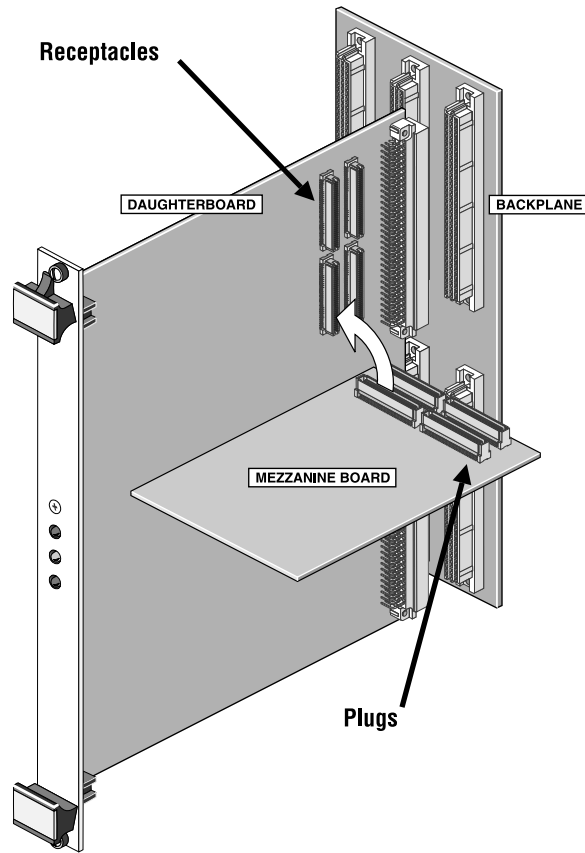

1.00mm (.039") Mezzanine IEEE 1386 Board-to-Board Plug/Receptacle

71436/71439
Dual Row, SMT
Vertical Stacking

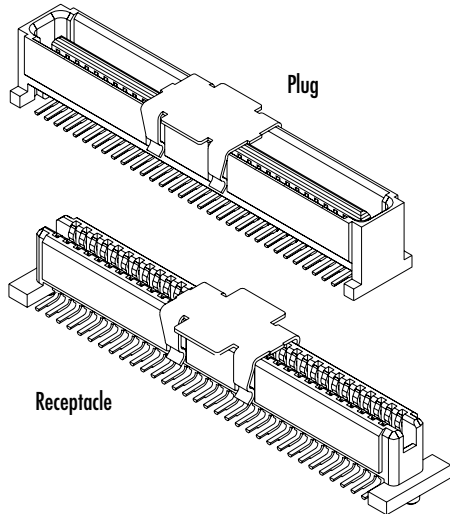

Features and Benefits

- Mated heights: 8, 9, 10, 11, 12, 13, 14 and 15mm
- Size 64 circuits
- Leaf-style design protects pins
- Low insertion force
- Up to 4 mated pairs can be used
- LCP housing for use with SMT processing temps

Reference Information

Product Specification: PS-71436-9999
Packaging: Tube or tape and reel
UL File No.: E29179

Electrical

Voltage: 100V
Current: 1.0A
Contact Resistance: 30 milliohms max.

Mechanical

Contact Retention to Housing: 0.4kgf min.
Mating Force: 50g max. per contact
Unmating Force: 25g min. per contact

Physical

Housing: Glass-filled LCP, UL 94V-0
Contact: Phosphor Bronze
Plating: 30µ" Gold min.

Circuits	Mated Stack Height	Pegs	Packaging	Order No.		Lead-free
				Plug	Receptacle	
64	8.00mm (.315")	Yes	Tape and Reel	71436-0464	71439-0464	Yes
			Tube	71436-0164	71439-0164	
		No	Tape and Reel	71436-0864	71439-0864	
			Tube	71436-0564	Contact Molex	
	9.00mm (.354")	Yes	Tape and Reel	71436-1464	71439-0464	
			Tube	71436-1164	71439-0164	
		No	Tape and Reel	71436-1864	71439-0864	
			Tube	71436-1564	Contact Molex	
	10.00mm (.394")	Yes	Tape and Reel	71436-2464	71439-0464	
			Tube	71436-2164	71439-0164	
		No	Tape and Reel	71436-2864	71439-0864	
			Tube	71436-2564	Contact Molex	
	11.00mm (.433")	Yes	Tape and Reel	71436-1464	71439-1464	
			Tube	71436-1164	71439-1164	
		No	Tape and Reel	71436-1864	71439-1864	
			Tube	71436-1564	71439-1564	
	12.00mm (.472")	Yes	Tape and Reel	71436-2464	71439-1464	
			Tube	71436-2164	71439-1164	
		No	Tape and Reel	71436-2864	71439-1864	
			Tube	71436-2564	71439-1564	
	13.00mm (.512")	Yes	Tape and Reel	71436-2464	71439-2464	
			Tube	71436-2164	71439-2164	
		No	Tape and Reel	71436-2864	71439-2864	
			Tube	71436-2564	Contact Molex	
14.00mm (.551")	Yes	Tape and Reel	71436-1464	71439-3464		
		Tube	71436-1164	71439-3164		
	No	Tape and Reel	71436-1864	71439-3864		
		Tube	71436-1564	71439-3564		
15.00mm (.591")	Yes	Tape and Reel	71436-2464	71439-3464		
		Tube	71436-2164	71439-3164		
	No	Tape and Reel	71436-2864	71439-3864		
		Tube	71436-2564	71439-3564		

Note: These order numbers are the recommended plug and receptacle combinations for mated stack heights per EIA standard 700 AAAB. Per EIA standard, board stack height measured from facing surfaces of parallel circuit boards includes solder thickness allowance of 0.1mm (.004") per side.

1.00mm (.039") Mezzanine Board-to-Board Plug/Receptacle

71741/71742
Dual Row, SMT
Vertical Stacking

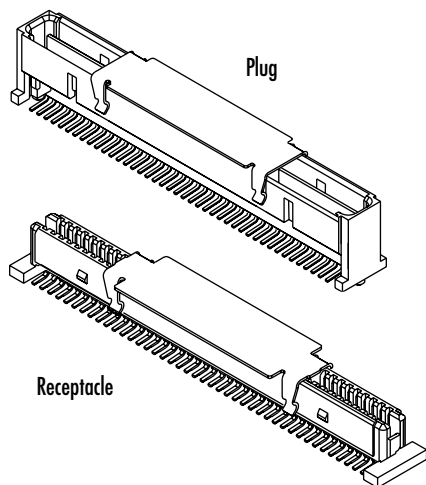

Features and Benefits

- Mated heights: 8, 10, 12, 13 and 15mm
- Leaf-style design protects pins
- Low insertion force
- Up to 4 mated pairs can be used
- LCP housing for use with lead-free SMT processing temps

Reference Information

Product Specification: PS-71741-9999
Packaging: Tube or tape and reel
UL File No.: E29179

Electrical

Voltage: 100V
Current: 1.0A
Contact Resistance: 40 milliohms max.

Mechanical

Contact Retention to Housing: 0.4kgf min.
Mating Force: 50g max.
Unmating Force: 25g min.

Physical

Housing: Glass-filled LCP, UL 94V-0
Contact: Phosphor Bronze
Plating: 30µ" and 10µ" Gold min.

Circuits	Mated Stack Height	Pegs	Packaging	Order No.		Lead-free
				Plug	Receptacle	
84	8.00mm (.315")	Yes	Tape and Reel	71741-2011	71742-0003* or 71742-0006	Yes
			Tube	Contact Molex	71742-0004	
		No	Tape and Reel	71741-2002	71742-0001* or 71742-0005	
			Tube	Contact Molex	Contact Molex	
	10.00mm (.394")	Yes	Tape and Reel	71741-0002* or 71741-0004	71742-0003* or 71742-0006	
			Tube	71741-0001*	71742-0004	
		No	Tape and Reel	71741-0003	71742-0001* or 71742-0005	
			Tube	Contact Molex	Contact Molex	
	12.00mm (.472")	Yes	Tape and Reel	71741-0002* or 71741-0004	71742-2001* or 71742-2003	
			Tube	71741-0002* or 71741-0004	71742-2002*	
		No	Tape and Reel	Contact Molex	Contact Molex	
			Tube	Contact Molex	Contact Molex	
	13.00mm (.512")	Yes	Tape and Reel	71741-2001	71742-3003	
			Tube	Contact Molex	Contact Molex	
		No	Tape and Reel	71741-2002	71742-3001	
			Tube	Contact Molex	Contact Molex	
	15.00mm (.591")	Yes	Tape and Reel	71741-0002* or 71741-0004	71742-3003	
			Tube	71741-0001*	Contact Molex	
		No	Tape and Reel	71741-0003	71742-3001	
			Tube	Contact Molex	Contact Molex	

Note: These order numbers are the recommended plug and receptacle combinations for mated stack heights per EIA standard 700 AAAB. Per EIA standard, board stack height measured from facing surfaces of parallel circuit boards includes solder thickness allowance of 0.1mm (.004") per side.

*.25µmm (10µ") Gold plating

1.00mm (.039") Pitch Pico-Clasp™ Wire-to-Board Crimp Terminal

501334
For Single Row Housings

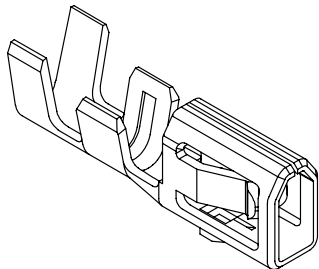

Order No.	Packaging	Lead-free
501334-0000	Reel	Yes
501334-0100	Bag	

Features and Benefits

- Box-shaped design provides 2 points of contact for secure electrical connection

Reference Information

Product Specification: PS-501331-001
Use With: 501330
Designed In: Millimeters

Electrical

Voltage: 50V max.
Current: 1.0A max.

Physical

Contact: Phosphor Bronze
Plating: Tin
Wire Size: 28 to 32 AWG
Insulation Diameter: 0.80mm (.031") max.
Wire Strip Length: 1.00 to 1.30mm (.039 to .051")

www.molex.com/customer.html?seriesNumber=501334

1.00mm (.039") Pitch Pico-Clasp™ Wire-to-Board Housing

501330
Single Row
Positive and Friction Lock

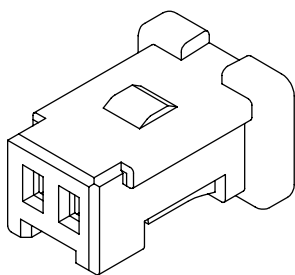

Features and Benefits

- Inner positive lock provides space savings and latch protection
- Molded guides provide polarization and mating assistance

Reference Information

Product Specification: PS-501331-001
Packaging: Bag
Mates With: 501331
Use With: 501334
Designed In: Millimeters

Electrical

Voltage: 50V max.
Current: 1.0A max.
Contact Resistance: 20 milliohms max.
Dielectric Withstanding Voltage: 250V AC/1 min.
Insulation Resistance: 100 Megohms min.

Physical

Housing: Nylon, UL 94V-0

Circuits	Order No.		Lead-free
	Positive Lock	Friction Lock	
2		501330-0200	Yes
3		501330-0300	
4		501330-0400	
5		501330-0500	
6	501330-0600		
7	501330-0700		
8	501330-0800		

Circuits	Order No.		Lead-free
	Positive Lock	Friction Lock	
9	501330-0900		Yes
10	501330-1000		
11	501330-1100		
12	501330-1200		
13	501330-1300		
14	501330-1400		
15	501330-1500		

1.00mm (.039") Pitch Pico-Clasp™ Wire-to-Board Header

501331
SMT, Single Row
Positive and Friction Lock

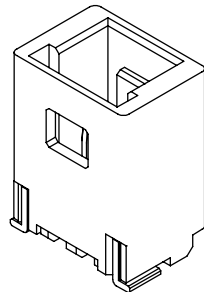

Features and Benefits

- Positive lock on 6-15 circuits; friction lock on 2-5 circuits
- Inner positive lock provides space savings and latch protection
- Molded guides provide polarization and mating assistance

Reference Information

Product Specification: PS-501331-001
Packaging: Embossed tape
Mates With: 501330
Designed In: Millimeters

Electrical

Voltage: 50V max.
Current: 1.0A max.
Contact Resistance: 20 milliohms max.
Dielectric Withstanding Voltage: 250V AC/1 min.
Insulation Resistance: 100 Megohms min.

Physical

Housing: Nylon, UL 94V-0
Contact: Phosphor Bronze
Plating: Tin over Nickel
Fitting Nail: Phosphor Bronze, Tin over Nickel plating

Circuits	Order No.		Lead-free
	Positive Lock	Friction Lock	
2		501331-0207	Yes
3		501331-0307	
4		501331-0407	
5		501331-0507	
6	501331-0607		
7	501331-0707		
8	501331-0807		

Circuits	Order No.		Lead-free
	Positive Lock	Friction Lock	
9	501331-0907		Yes
10	501331-1007		
11	501331-1107		
12	501331-1207		
13	501331-1307		
14	501331-1407		
15	501331-1507		

www.molex.com/customer.html?seriesNumber=501331

1.00mm (.039") Pitch Pico-Clasp™ Wire-to-Board Housing

501189
Dual Row

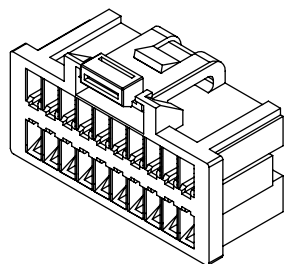

Features and Benefits

- Inner positive lock provides space savings and latch protection
- Molded guides provide polarization and mating assistance

Reference Information

Product Specification: PS-501190-001; PS-501190-002
Packaging: Bag
Mates With: 501190
Use With: 501193
Designed In: Millimeters

Electrical

Voltage: 50V max.
Current: 1.0A max.
Contact Resistance: 20 milliohms max.
Dielectric Withstanding Voltage: 250V AC/1 min.
Insulation Resistance: 100 Megohms min.

Physical

Housing: Nylon, UL 94V-0

Circuits	Order No.		Lead-free
	Positive Lock	Side Friction Lock	
20	501189-2010	501189-2021	Yes
30	501189-3010	501189-3021	
40	501189-4010	501189-4021	
50	501189-5010	501189-5021	

1.00mm (.039") Pitch Pico-Clasp™ Wire-to-Board Crimp Terminal

501193
For Dual Row
Housings

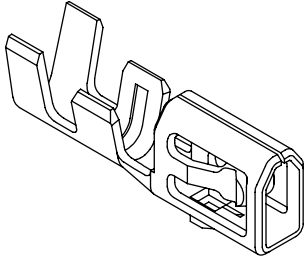

Order No.	Package	Lead-free
501193-2000	Reel	Yes

Features and Benefits

- Box-shaped design provides 2 points of contact for secure electrical connection

Reference Information

Product Specification: PS-501190-001 and PS-501190-002
Packaging: Reel
Use With: 501189
Designed In: Millimeters

Electrical

Voltage: 50V
Current: 1.0A max.

Physical

Contact: Phosphor Bronze
Plating: Gold over Nickel
Wire Size: 28 to 32 AWG
Insulation Diameter: 0.80mm (.031") max.
Wire Strip Length: 1.00 to 1.30mm (.039 to .051")

www.molex.com/customer.html?seriesNumber=501193

1.00mm (.039") Pitch Pico-Clasp™ Wire-to-Board Header

501190
Dual Row, SMT

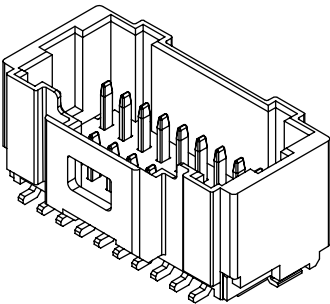

Features and Benefits

- Inner positive lock provides space savings and latch protection
- Molded guides provide polarization and mating assistance

Reference Information

Product Specification: PS-501190-001 and PS-501190-002
Packaging: Embossed tape
Mates With: 501189
Designed In: Millimeters

Electrical

Voltage: 50V max.
Current: 1.0A max.
Contact Resistance: 20 milliohms max.
Dielectric Withstanding Voltage: 250V AC/1 min.
Insulation Resistance: 100 Megohms min.

Physical

Housing: Nylon, UL 94V-0
Contact: Phosphor Bronze
Plating: Gold over Nickel
Fitting Nail: Phosphor Bronze, Tin over Nickel plating

Circuits	Order No.		Lead-free
	With Pick-and-Place Cover Tape	Without Pick-and-Place Cover Tape	
20	501190-2017	501190-2027	Yes
30	501190-3017	501190-3027	
40	501190-4017	501190-4027	
50	501190-5017	501190-5027	

1.25mm (.049") Pitch

B

0.40 to 1.60mm (.016 to .063") Pitch PCB and Wire Connectors

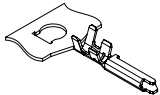
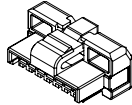
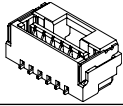
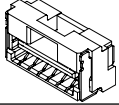
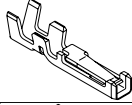
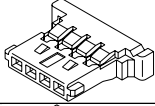
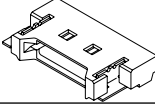
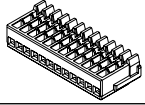
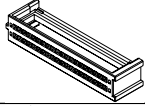
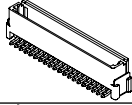
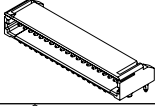
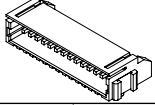
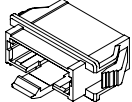
Pitch	Series		Tradename	Description	Unmated Height
1.25mm (.049")	502381		CLIK-Mate™	Crimp Terminal	
	502380			Housing	
	502382			Receptacle	
	502386			Receptacle	
	50641		PanelMate™	Female Crimp Terminal	
	51146			Housing	Ultra Low
	53780			Header	1.90mm (.075")
	54596		Mini Mi II™	IDT Receptacle	
	54597			Clip	
	55450			Header	6.75mm (.266")
	55454			Header	
	55456			Header	4.50mm (.177")
	55482			Adapter	

1.25mm (.049") Pitch CLIK-Mate™ Wire-to-Board Crimp Terminal

502381
For Single Row
Housings

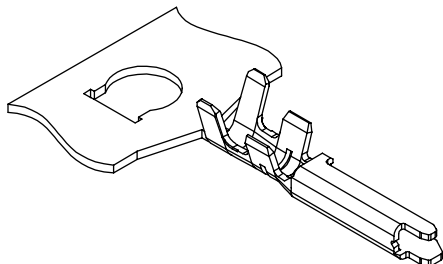

Order No.	Lead-free
502381-0000	Yes

Reference Information
Product Specification: PS-502382-001
Packaging: Reel
Use With: 502380 housing
Designed In: Millimeters

Electrical
Voltage: 50V max.
Current: 1.0A max.

Physical
Contact: Copper Alloy
Plating: Tin over Nickel
Insulation Diameter: 1.0mm dia. max.
Strip Length: 1.50 to 1.70 mm
Wire Gauge: 26 to 28 AWG

1.25mm (.049") Pitch CLIK-Mate™ Wire-to-Board Housing

502380
Single Row
Positive Lock

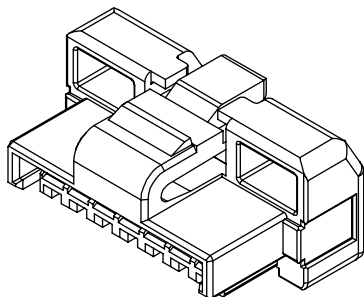

Features and Benefits

- Sizes 2 to 15 circuits
- Audible "click," low insertion force and secure mating
- Tuning fork style contact design secures contact and avoids terminal stubbing

Reference Information
Product Specification: PS-502382-001
Packaging: Bag
Mates With: 502382, 502386
Use With: 502381 terminal
Designed In: Millimeters

Electrical
Voltage: 50V max.
Current: 1.0A max.
Contact Resistance: 20 milliohms max.
Dielectric Withstanding Voltage: 500V AC/1 min.
Insulation Resistance: 100 Megohms min.

Physical
Housing: White PBT, UL 94V-0

Circuits	Order No.	Lead-free
2	502380-0200	Yes
3	502380-0300	
4	502380-0400	
5	502380-0500	
6	502380-0600	
7	502380-0700	
8	502380-0800	

Circuits	Order No.	Lead-free
9	502380-0900	Yes
10	502380-1000	
11	502380-1100	
12	502380-1200	
13	502380-1300	
14	502380-1400	
15	502380-1500	

Note: 2-7 circuits has single lock (shown above) and 8-15 circuits has dual locks. See drawings for details.

1.25mm (.049") Pitch CLIK-Mate™ Wire-to-Board PCB Receptacle

502382
Single Row
Vertical

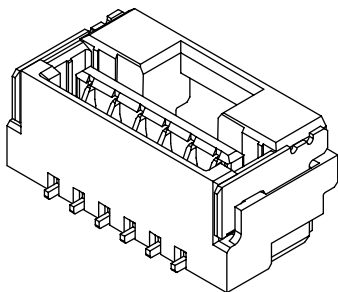

Features and Benefits

- Sizes 2 to 15 circuits
- Audible "click," low insertion force and secure mating
- Tuning fork style contact design secures contact and avoids terminal stubbing
- Reinforced metal solder tabs enable housing wall support and secure PCB retention
- Flat area for pick-and-place is provided

Reference Information

Product Specification: PS-502382-001
Packaging: Embossed tape
Mates With: 502380
Designed In: Millimeters

Electrical

Voltage: 50V max.
Current: 1.0A max.
Contact Resistance: 20 milliohms max.
Dielectric Withstanding Voltage: 500V AC/1 min.
Insulation Resistance: 100 Megohms min.

Physical

Housing: Heatproof resin, UL 94V-0
Contact: Copper Alloy
Plating: Tin over Nickel
Fitting Nail: Copper Alloy, Tin over Nickel plating

Circuits	Order No.	Lead-free
2	502382-0270	Yes
3	502382-0370	
4	502382-0470	
5	502382-0570	
6	502382-0670	
7	502382-0770	
8	502382-0870	

Circuits	Order No.	Lead-free
9	502382-0970	Yes
10	502382-1070	
11	502382-1170	
12	502382-1270	
13	502382-1370	
14	502382-1470	
15	502382-1570	

Note: 2-7 circuits has single lock (shown above) and 8-15 circuits has dual locks. See drawings for details.

1.25mm (.049") Pitch CLIK-Mate™ Wire-to-Board PCB Receptacle

502386
Single Row
Right Angle

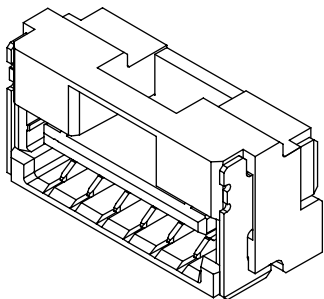

Features and Benefits

- Sizes 2 to 15 circuits
- Audible "click," low insertion force and secure mating
- Tuning fork style contact design secures contact and avoids terminal stubbing
- Reinforced metal solder tabs enable housing wall support and secure PCB retention
- Flat area for pick-and-place is provided

Reference Information

Product Specification: PS-502382-001
Packaging: Embossed tape
Mates With: 502380
Designed In: Millimeters

Electrical

Voltage: 50V max.
Current: 1.0A max.
Contact Resistance: 20 milliohms max.
Dielectric Withstanding Voltage: 500V AC/1 min.
Insulation Resistance: 100 Megohms min.

Physical

Housing: Heatproof resin, UL 94V-0
Contact: Copper Alloy
Plating: Tin over Nickel
Fitting Nail: Copper Alloy, Tin over Nickel plating

Circuits	Order No.	Lead-free
2	502386-0270	Yes
3	502386-0370	
4	502386-0470	
5	502386-0570	
6	502386-0670	
7	502386-0770	
8	502386-0870	

Circuits	Order No.	Lead-free
9	502386-0970	Yes
10	502386-1070	
11	502386-1170	
12	502386-1270	
13	502386-1370	
14	502386-1470	
15	502386-1570	

Note: 2-7 circuits has single lock (shown above) and 8-15 circuits has dual locks. See drawings for details.

1.25mm (.049") Pitch PanelMate™ Wire-To-Board Crimp Terminal 50641

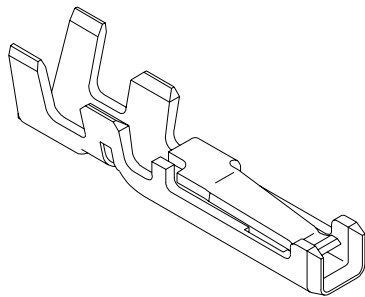

Order No.	Packaging	Lead-free
50641-8041	Reel	Yes
50641-8141	Bag	

Features and Benefits

- Box-style contact design provides protection and secure mating force
- Locking tang latches into housing window

Reference Information

Use With: 51146
Designed In: Millimeters

Electrical

Voltage: 125V max.
Current: 1.0A max.

Physical

Contact: Phosphor Bronze
Plating: Gold over Nickel
Wire Range: 28 to 30 AWG
Insulation Diameter: 0.50 to 0.90mm (.020 to .035") max.
Strip Length: 1.3 to 1.7mm

1.25mm (.049") Pitch PanelMate™ Wire-to-Board Housing 51146 Ultra Low Profile

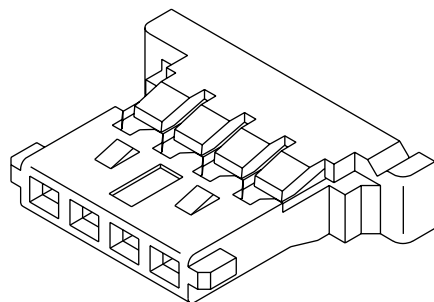

Features and Benefits

- Sizes 2 to 20 circuits
- Very thin design (1.80mm)
- Housing lance provides extra terminal retention
- Friction lock provides secure mating
- Polarized design

Reference Information

Product Specification: PS-51146-010
Packaging: Bag
Use With: 50641 terminal
Mates With: 53780
Designed In: Millimeters

Electrical

Voltage: 125V max.
Current: 1.0A max.
Contact Resistance: 20 milliohms max.
Dielectric Withstanding Voltage: 250V AC/1 min.
Insulation Resistance: 100 Megohms min.

Physical

Housing: PBTP, UL 94V-0

Circuits	Order No.
2	51146-0200
3	51146-0300
4	51146-0400
5	51146-0500
6	51146-0600
7	51146-0700
8	51146-0800

Circuits	Order No.
9	51146-0900
12	51146-1200
14	51146-1400
15	51146-1500
18	51146-1800
20	51146-2000

1.25mm (.049") Pitch PanelMate™ Wire-to-Board Header

53780
Right Angle, SMT
1.90mm (.075") Profile

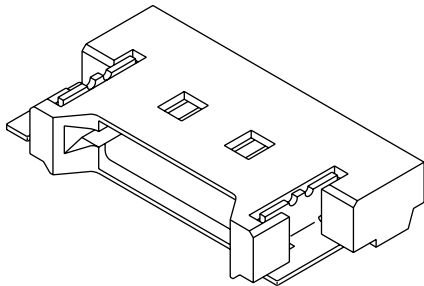

Features and Benefits

- Sizes 2 to 20 circuits
- Ultra low mating profile of 1.90mm (.075")
- Durable blade-type pins protect against damage during mating
- Metal solder tabs provide PCB retention and strain relief for SMT tails
- Solder-conducting fillet SMT tail design helps ensure stable solder joints
- Fully-shrouded anti-flux wicking design protects contacts during soldering and cleaning processes

Reference Information

Product Specification: PS-51146-010
Packaging: Embossed tape
Mates With: 51146
Designed In: Millimeters

Electrical

Voltage: 125V max.
Current: 1.0A max.
Contact Resistance: 40 milliohms max.
Dielectric Withstanding Voltage: 250V AC/1 min.
Insulation Resistance: 100 Megohms min.

Physical

Housing: PPS, UL 94V-0
Contact: Phosphor Bronze
Plating: Contact Area—Gold over Nickel
Solder Tail Area—Tin over Nickel
Fitting Nail: Phosphor Bronze, Tin over Nickel plating

Circuits	Order No.	Lead-free
2	53780-0270	Yes
3	53780-0370	
4	53780-0470	
5	53780-0570	
6	53780-0670	
7	53780-0770	
8	53780-0870	

Circuits	Order No.	Lead-free
9	53780-0970	Yes
12	53780-1270	
14	53780-1470	
15	53780-1570	
18	53780-1870	
20	53780-2070	

www.molex.com/product/micro/pnlmate.html

1.25mm (.049") Pitch Mini Mi II™ System Wire-to-Board Receptacle

54596
Single Row
IDT

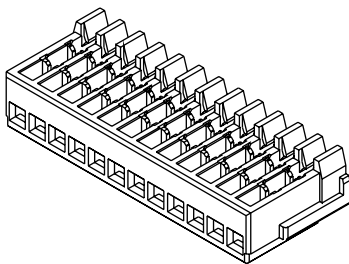

Features and Benefits

- Sizes 2 to 20 circuits
- IDT provides secure and cost-effective termination
- Contact design protects header pins during mating/unmating
- Housing length designed for easy handling
- IDT guide slots facilitate wire placement
- Side ribs provide polarization and locking to clip

Reference Information

Packaging: Bag
Mates With: 55450, 55454, 55456, 55482, 55447
Use With: 54597 clip for dual-row applications
Designed In: Millimeters

Electrical

Voltage: 100V max.
Current: 1.5A max.
Contact Resistance: 20 milliohms max.
Dielectric Withstanding Voltage: 500V AC/1 min.
Insulation Resistance: 1000 Megohms min.

Physical

Housing: Nylon, UL 94V-0
Contact: Phosphor Bronze
Plating: Tin
Wire Range: 26 to 28 AWG
Insulation Range: 0.80 to 0.90mm (.031 to .035") dia.

Circuits	Order No.	Lead-free
2	54596-0210	Yes
3	54596-0310	
4	54596-0410	
5	54596-0510	
6	54596-0610	
7	54596-0710	
8	54596-0810	

Circuits	Order No.	Lead-free
9	54596-0910	Yes
10	54596-1010	
11	54596-1110	
12	54596-1210	
13	54596-1310	
14	54596-1410	
15	54596-1510	

Circuits	Order No.	Lead-free
16	54596-1610	Yes
17	54596-1710	
18	54596-1810	
19	54596-1910	
20	54596-2010	

1.25mm (.049") Pitch Mini Mi II™ Wire-to-Board Header

55450
SMT, Single Row
Vertical

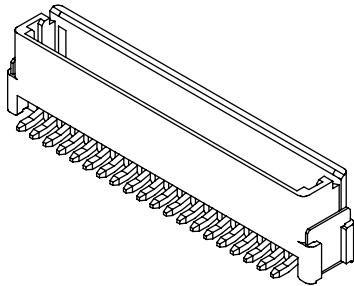

Features and Benefits

- Sizes 2 to 20 circuits
- Friction lock provides secure mating
- Polarized inner walls provide correct mating orientation

Reference Information

Product Specification: PS-54596-022
Packaging: Embossed tape
Mates With: 54596
Designed In: Millimeters

Electrical

Voltage: 100V max.
Current: 1.5A max.
Contact Resistance: 20 milliohms max.
Dielectric Withstanding Voltage: 500V AC/1 min.
Insulation Resistance: 1000 Megohms min.

Physical

Housing: Nylon, UL 94V-0
Contact: Brass
Plating: Tin
Fitting Nail: Brass, Tin plating

Circuits	Order No.	Lead-free
2	55450-0269	Yes
3	55450-0369	
5	55450-0569	
6	55450-0669	
7	55450-0769	
8	55450-0869	
10	55450-1069	
11	55450-1169	

Circuits	Order No.	Lead-free
12	55450-1269	Yes
13	55450-1369	
14	55450-1469	
15	55450-1569	
16	55450-1669	
18	55450-1869	
20	55450-2069	

1.25mm (.049") Pitch Mini Mi II™ System Clip

54597
Dual Row

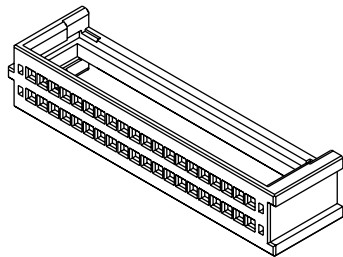

Features and Benefits

- Sizes 10 to 40 circuits
- Joins two single row receptacles (54596)
- Polarized to ensure correct mating orientation
- Locking feature ensures secure receptacle retention

Reference Information

Product Specification: PS-55659-005, PS-54596-007
Packaging: Bag
Mates With: 55659, 55451
Use With: 54596
Designed In: Millimeters

Physical

Housing: Nylon, UL 94V-0

Circuits	Order No.	Lead-free
10	54597-1000	Yes
12	54597-1200	
14	54597-1400	
16	54597-1600	
18	54597-1800	
20	54597-2000	

Circuits	Order No.	Lead-free
22	54597-2200	Yes
24	54597-2400	
26	54597-2600	
28	54597-2800	
30	54597-3000	
32	54597-3200	

Circuits	Order No.	Lead-free
34	54597-3400	Yes
36	54597-3600	
38	54597-3800	
40	54597-4000	

1.25mm (.049") Pitch Mini Mi II™ System Wire-to-Board Header

55454
Single Row
Right Angle

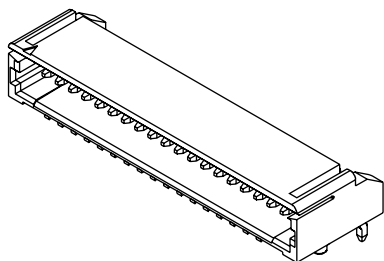

Features and Benefits

- Sizes 2 to 20 circuits
- Friction lock provides secure mating
- Kinked outer tails for additional PCB retention
- Polarized inner side-walls ensure correct mating orientation
- Extended outer side-walls protect solder tails
- Polarizing pegs assist board placement

Reference Information

Product Specification: PS-54596-018
Packaging: Tray
Mates With: 54596
Designed In: Millimeters

Electrical

Voltage: 100V max.
Current: 1.5A max.
Contact Resistance: 20 milliohms max.
Dielectric Withstanding Voltage: 500V AC/1 min.
Insulation Resistance: 1000 Megohms min.

Physical

Housing: Nylon, UL 94V-0
Contact: Brass
Plating: Tin

Circuits	Order No.	Lead-free
2	55454-0270	Yes
3	55454-0370	
4	55454-0470	
5	55454-0570	
6	55454-0670	
7	55454-0770	
8	55454-0870	

Circuits	Order No.	Lead-free
9	55454-0970	Yes
10	55454-1070	
11	55454-1170	
12	55454-1270	
13	55454-1370	
14	55454-1470	
15	55454-1570	

Circuits	Order No.	Lead-free
16	55454-1670	Yes
17	55454-1770	
18	55454-1870	
19	55454-1970	
20	55454-2070	

1.25mm (.049") Pitch Mini Mi II™ Wire-to-Board Header

55456
SMT, Single Row, Right Angle

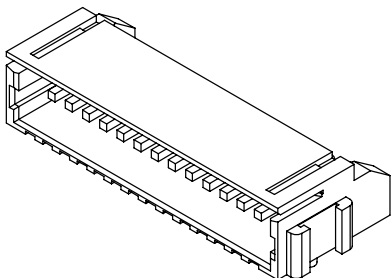

Features and Benefits

- Sizes 4 to 20 circuits
- Polarizing pegs assist board placement

Reference Information

Product Specification: PS-54596-022
Packaging: Embossed tape
Mates With: 54596
Designed In: Millimeters

Electrical

Voltage: 100V max.
Current: 1.5A max.
Contact Resistance: 20 milliohms max.
Dielectric Withstanding Voltage: 500V AC/1 min.
Insulation Resistance: 1000 Megohms min.

Physical

Housing: Nylon, UL 94V-0
Contact: Brass
Plating: Tin
Fitting Nail: Brass, Tin plating

Circuits	Order No.		Lead-free
	With Pegs	Without Pegs	
2		55456-0269	Yes
4	55456-0459	55456-0469	
5	55456-0559	55456-0569	
7	55456-0759	55456-0769	
11	55456-1159	55456-1169	
12		55456-1269	
13	55456-1359	55456-1369	
16	55456-1659	55456-1669	
18	55456-1859	55456-1869	
20	55456-2059	55456-2069	

1.25mm (.049") Pitch Mini Mi II™ Wire-to-Wire Adapter 55482 Single Row

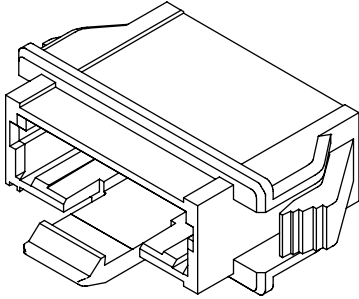

Features and Benefits

- Provides panel-mount method of linking harnesses
- Mounting ears provide good spring characteristics and strong panel retention

Reference Information

Product Specification: PS-55482-006
Packaging: Bag
Use With: 54596
Designed In: Millimeters

Electrical

Voltage: 100V max.
Current: 1.5A max.
Contact Resistance: 40 milliohms max.
Dielectric Withstanding Voltage: 500V AC/1 min.
Insulation Resistance: 1000 Megohms min.

Physical

Housing: Nylon, UL 94V-0
Contact: Brass
Plating: Tin over Copper



Circuits	Order No.	Lead-free
2	55482-0219	Yes
3	55482-0319	
4	55482-0419	
5	55482-0519	
6	55482-0619	
7	55482-0719	
8	55482-0819	
9	55482-0919	
10	55482-1019	
11	55482-1119	

Circuits	Order No.	Lead-free
12	55482-1219	Yes
13	55482-1319	
14	55482-1419	
15	55482-1519	
16	55482-1619	
17	55482-1719	
18	55482-1819	
19	55482-1919	
20	55482-2019	

1.25mm (.049") Pitch

B

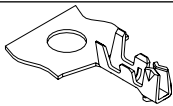
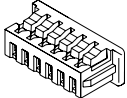
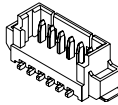
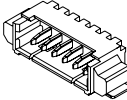
0.40 to 1.60mm (.016 to .063") Pitch PCB and Wire Connectors

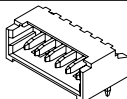
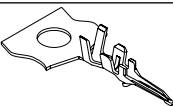
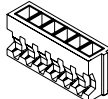
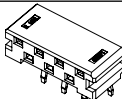
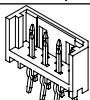
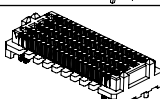
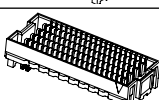
Pitch	Series		Tradename	Description
1.25mm (.049")	50079/50058		PicoBlade™	Female Crimp Terminal
	51021			Housing
	53398			Header
	53261			Header
	53047			Header
	53048			Header
	50061/50080			Board-In
	51022		Housing	
	87871		ZigZag	
	87872			Header
1.27 x 1.27mm (.050 x .050")	45970		Searay*	Plug
	45971			Receptacle

*SEARAY is a trademark of Samtec, Inc.

1.25mm (.049") Pitch PicoBlade™ Wire-to-Board and Wire-to-Wire Crimp Terminal

50079/50058
Female

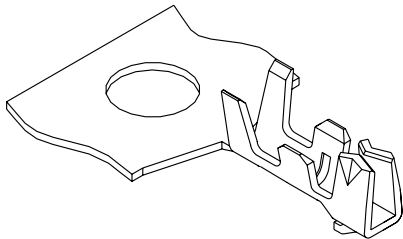

Order No.	Wire Range AWG	Packaging	Lead-free
50079-8000	26 - 28	Reel	Yes
50058-8000	28 - 32		
50079-8100	26 - 28	Bag	
50058-8100	28 - 32		

Features and Benefits

- Locking tang for secure housing retention

Reference Information

Use With: 51021
Designed In: Millimeters

Electrical

Voltage: 125V max.
Current: 1.0A max.

Physical

Contact: Phosphor Bronze
Plating: Tin
Insulation Range: 50058—1.00mm dia. max.
50079—1.04mm dia. max.
Strip Length: 1.40 to 1.90mm

1.25mm (.049") Pitch PicoBlade™ Wire-to-Wire and Wire-to-Board Receptacle

51021

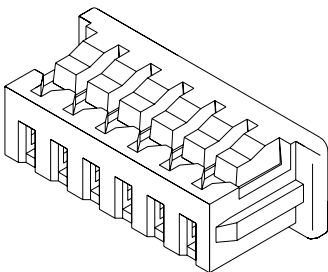

Features and Benefits

- Sizes 2 to 15 circuits
- Housing lance provides extra terminal retention
- Friction locks provide secure mating

Reference Information

Product Specification: Refer to Mates With items
Packaging: Bag
UL File No.: E29179
CSA File No.: LR19980
Use With: 50079/50058
Mates With: 53398, 53261, 53047, 53048
Designed In: Millimeters

Electrical

Voltage: 125V max.
Current: 1.0A max.
Contact Resistance: 20 milliohms max.
Dielectric Withstanding Voltage: 250V AC/1 min.
Insulation Resistance: 100 Megohms min.

Physical

Housing: PBTP, UL 94V-0

Circuits	Order No.
2	51021-0200
3	51021-0300
4	51021-0400
5	51021-0500
6	51021-0600
7	51021-0700
8	51021-0800

Circuits	Order No.
9	51021-0900
10	51021-1000
11	51021-1100
12	51021-1200
13	51021-1300
14	51021-1400
15	51021-1500

1.25mm (.049") Pitch PicoBlade™ Wire-to-Board Header

53398
Vertical, SMT

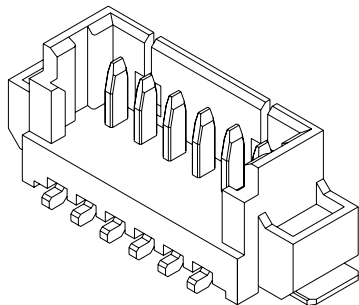

Features and Benefits

- Sizes 2 to 15 circuits
- Locking windows provide secure mating
- Fitting nails provide PCB hold-down and strain relief for SMT tails

Reference Information

Product Specification: PS-51021-024
Packaging: Embossed tape
Mates With: 51021
Designed In: Millimeters

Electrical

Voltage: 125V max.
Current: 1.0A max.
Contact Resistance: 20 milliohms max.
Dielectric Withstanding Voltage: 250V AC/1 min.
Insulation Resistance: 100 Megohms min.

Physical

Housing: Nylon, UL 94V-0
Contact: Phosphor Bronze
Plating: Tin over Nickel
Fitting Nails: Phosphor Bronze, Tin over Nickel plating

Circuits	Order No.	Lead-free
2	53398-0271	Yes
3	53398-0371	
4	53398-0471	
5	53398-0571	
6	53398-0671	
7	53398-0771	
8	53398-0871	

Circuits	Order No.	Lead-free
9	53398-0971	Yes
10	53398-1071	
11	53398-1171	
12	53398-1271	
13	53398-1371	
14	53398-1471	
15	53398-1571	

Note: 53398-XX84 is available with High-Barrier (moisture protection) packaging.

1.25mm (.049") Pitch PicoBlade™ Wire-to-Board Header

53261
Right Angle, SMT

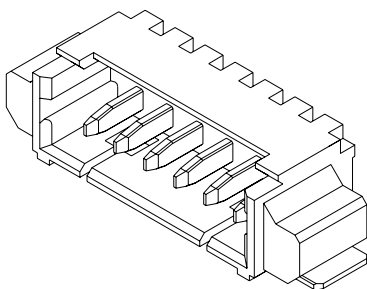

Features and Benefits

- Sizes 2 to 15 circuits
- Locking windows provide secure mating
- Metal solder tabs provide PCB hold-down and strain relief for SMT tails

Reference Information

Product Specification: PS-51021-024
Packaging: Embossed tape
UL File No.: E29179
CSA File No.: LR19980
Mates With: 51021
Designed In: Millimeters

Electrical

Voltage: 125V max.
Current: 1.0A max.
Contact Resistance: 20 milliohms max.
Dielectric Withstanding Voltage: 250V AC/1 min.
Insulation Resistance: 100 Megohms min.

Physical

Housing: Nylon, UL 94V-0
Contact: Phosphor Bronze
Plating: Tin over Nickel
Fitting Nails: Phosphor Bronze, Tin over Nickel plating

Circuits	Order No.	Lead-free
2	53261-0271	Yes
3	53261-0371	
4	53261-0471	
5	53261-0571	
6	53261-0671	
7	53261-0771	
8	53261-0871	

Circuits	Order No.	Lead-free
9	53261-0971	Yes
10	53261-1071	
11	53261-1171	
12	53261-1271	
14	53261-1471	
15	53261-1571	

1.25mm (.049") Pitch PicoBlade™ Wire-to-Board Header 53048 Right Angle

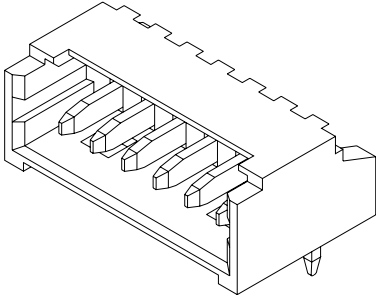

Features and Benefits

- Sizes 2 to 15 circuits
- Locking windows provide secure mating

Reference Information

Product Specification: PS-51021-010
Packaging: Tray
Mates With: 51021
Designed In: Millimeters

Electrical

Voltage: 125V max.
Current: 1.0A max.
Contact Resistance: 20 milliohms max.
Dielectric Withstanding Voltage: 250V AC/1 min.
Insulation Resistance: 100 Megohms min.

Physical

Housing: Nylon, UL 94V-0
Contact: Phosphor Bronze
Plating: Tin

Circuits	Order No.	Lead-free
2	53048-0210	Yes
3	53048-0310	
4	53048-0410	
5	53048-0510	
6	53048-0610	
7	53048-0710	
8	53048-0810	

Circuits	Order No.	Lead-free
9	53048-0910	Yes
10	53048-1010	
11	53048-1110	
12	53048-1210	
13	53048-1310	
14	53048-1410	
15	53048-1510	

1.25mm (.049") Pitch PicoBlade™ Wire-to-Board Header 53047 Vertical

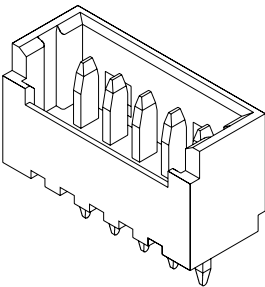

Features and Benefits

- Sizes 2 to 15 circuits
- Locking windows provide secure mating

Reference Information

Product Specification: PS-51021-010
Packaging: Tray
Mates With: 51021
Designed In: Millimeters

Electrical

Voltage: 125V max.
Current: 1.0A max.
Contact Resistance: 20 milliohms max.
Dielectric Withstanding Voltage: 250V AC/1 min.
Insulation Resistance: 100 Megohms min.

Physical

Housing: Nylon, UL 94V-0
Contact: Phosphor Bronze
Plating: Tin

Circuits	Order No.	Lead-free
2	53047-0210	Yes
3	53047-0310	
4	53047-0410	
5	53047-0510	
6	53047-0610	
7	53047-0710	
8	53047-0810	

Circuits	Order No.	Lead-free
9	53047-0910	Yes
10	53047-1010	
11	53047-1110	
12	53047-1210	
13	53047-1310	
14	53047-1410	
15	53047-1510	

1.25mm (.049") Pitch Board-In Connector Crimp Terminal

50061/50080

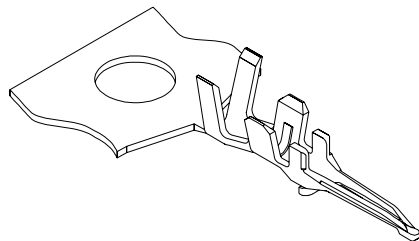

Order No.	Wire Range AWG	Packaging	Lead-free
50061-8000	28-32	Reel	Yes
50080-8000	26-28		
50061-8100	28-32	Bag	
50080-8100	26-28		

Features and Benefits

- Locking tang secures terminal to housing

Reference Information

Use With: 51022
Designed In: Millimeters

Electrical

Voltage: 125V max.
Current: 1.0A max.

Physical

Contact: Phosphor Bronze
Plating: Tin
Insulation Range: 1.00mm dia. max.
Strip Length: 1.40 to 1.90mm

www.molex.com/product/board_in.html

1.25mm (.049") Pitch Board-to-Board ZIGZAG Receptacle

87871

With Friction Lock

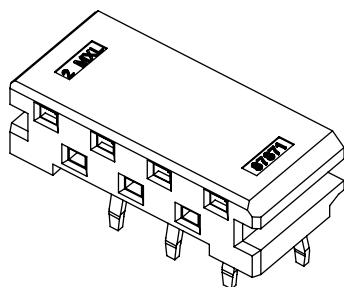

Circuits	Order No.	Lead-free
3	87871-2203	Yes
5	87871-2205	
7	87871-2207	
9	87871-2209	
11	87871-2211	
13	87871-2213	
15	87871-2215	
17	87871-2217	
19	87871-2219	
21	87871-2221	
23	87871-2223	

Features and Benefits

- Sizes 3 to 23 circuits
- Kinked solder tails provide retention to the PCB
- Polarization to ensure proper mating
- Friction lock provides passive lock to mating connector
- Tape and reel packaging options available

Reference Information

Product Specification: PS-87871-006
Packaging: Tube
UL File No.: E29179
CSA File No.: LR19980
Mates With: 87872
Designed In: Millimeters

Electrical

Voltage: 125V
Current: 2.0A
Contact Resistance: 40 milliohms max.
Dielectric Withstanding Voltage: 500V AC / 1 min.
Insulation Resistance: 1000 Megohms min.

Physical

Housing: Glass-filled nylon, UL94V-0
Contact: Phosphor Bronze
Plating: Tin
PCB Thickness: 1.60mm

1.25mm (.049") Pitch Board-In Connector Housing

51022

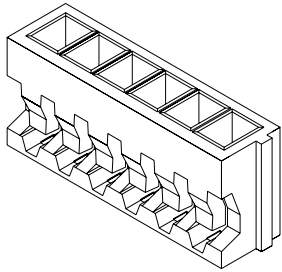

Features and Benefits

- Sizes 2 to 6 circuits
- Low profile of 3.50mm (.138")
- Locking window secures terminal to housing

Reference Information

Product Specification: PS-51022-001
 Packaging: Bag
 Use With: 50061/50080
 Designed In: Millimeters

Electrical

Voltage: 125V max.
 Current: 1.0A max.
 Contact Resistance: 5 milliohms max.
 Dielectric Withstanding Voltage: 250V AC/1 min.
 Insulation Resistance: 100 Megohms min.

Physical

Housing: Polyester, UL 94V-0

Circuits	Order No.
2	51022-0200
3	51022-0300
4	51022-0400
5	51022-0500
6	51022-0600

www.molex.com/product/board_in.html

1.25mm (.049") Pitch Board-to-Board ZIGZAG Header

87872

With Friction Lock

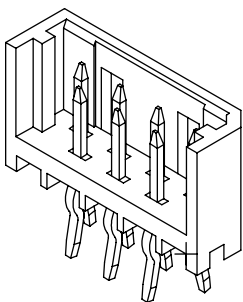

Features and Benefits

- Sizes 3 to 23 circuits
- Kinked solder tails provide retention to the PCB
- Polarization to ensure proper mating
- Friction lock provides passive lock to mating connector

Reference Information

Product Specification: PS-87871-006
 Packaging: Tube
 UL File No.: E29179
 CSA File No.: LR19980
 TUV File No.:
 Mates With: 87871
 Designed In: Millimeters

Electrical

Voltage: 125V
 Current: 2.0A
 Contact Resistance: 40 milliohms max.
 Dielectric Withstanding Voltage: 500V AC / 1 min.
 Insulation Resistance: 1000 Megohms min.

Physical

Housing: Glass-filled nylon, UL94V-0
 Contact: Brass
 Plating: Tin
 PCB Thickness: 1.60mm

Circuits	Order No.	Lead-free
3	87872-1103	Yes
5	87872-1105	
7	87872-1107	
9	87872-1109	
11	87872-1111	
13	87872-1113	
15	87872-1115	
17	87872-1117	
19	87872-1119	
21	87872-1121	
23	87872-1123	

**1.27 x 1.27mm
(.050 x .050") Pitch
SEARAY*
Board-to-Board
Plug and Receptacle
45970/45971
SMT, Pin Field
Vertical Stacking**

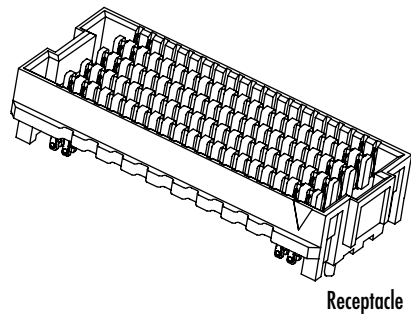
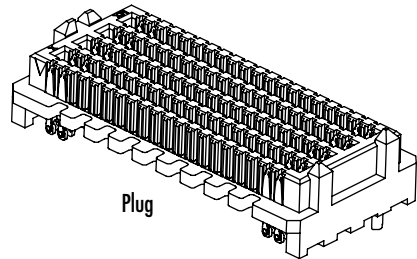

Features and Benefits

- RoHS Compliant solder charge for SMT
- Recessed contacts prevent stubbing
- Guide beams for gross alignment
- 7.00 to 13.00mm (.276 to .512") mated heights
- 100 to 500 circuits available

Reference Information

Product Specification: PS-45970-001
Packaging: Tray
Designed In: Inches

Electrical

Voltage: 250V AC
Current: 1.0A
Contact Resistance: 25 milliohms nom.
Dielectric Withstanding Voltage: 500V DC
Insulation Resistance: 5000 Megohms min.

Mechanical

Mating Force: 50g max.
Unmating Force: 30g max.
Normal Force: 82g max.
Durability: 100 cycles

Physical

Housing: Glass-filled LCP, UL 94V-0
Contact: Copper Alloy
Plating: Contact Area—0.75µm Gold min.
Solder Tail Area—3.80µm Tin min.
Underplating—1.25µm Nickel min. overall





Circuits	Order No.	Description	Lead-free
114	45970-9111	Plug	Yes
200	45970-2311		
400	45970-4111		
	45970-4311		

Circuits	Order No.	Description	Lead-free
114	45971-9111	Receptacle	Yes
200	45971-2311		
400	45971-4111		
	45971-4411		

Notes:
1) Refer to the product sales drawing for mated stack height options
2) Please contact Molex for other circuit sizes, mated stack heights and no peg options
3) Please contact Molex for SEARAY parts with Tin/Lead solder charges

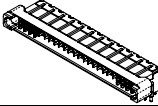
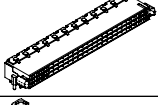
*SEARAY is a trademark of Samtec, Inc.

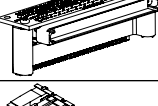
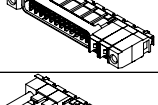
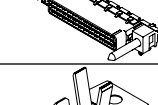
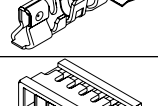
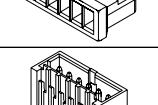
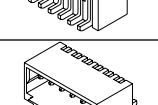
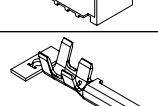
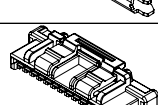
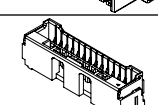
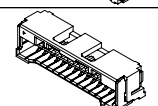
1.50mm (.059")–1.60mm (.062") Pitch

Pitch	Series		Tradename	Description
1.50mm (.059")	75018		Plateau HS Dock™	Plug
	75019			Receptacle
	75140			Plug
	75126			Interposer Plug
	75475		Plateau HS Dock™ PG	Plug
	75476			Receptacle
	87421		Pico-SPOX™	Female Crimp Terminal
	87439			Housing
	87437			Header
	87438			Header
	502579		CLIK-Mate™	Crimp Terminal
	502578			Housing
	502584			Receptacle
	502585			Receptacle

B
0.40 to 1.60mm (.016 to .063") Pitch PCB and Wire Connectors

1.50mm (.059") Pitch CLI-K-Mate™ Wire-to-Board Crimp Terminal

502579

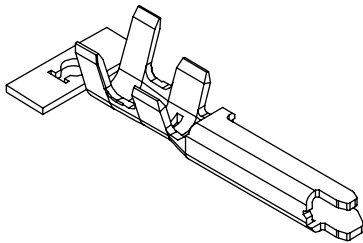

Order No.	Packaging	Lead-free
502579-0000	Reel	Yes

Reference Information

Product Specification: PS-502584-001
Packaging: Reel
Use With: 502578 housing
Designed In: Millimeters

Electrical

Voltage: 100V max.
Current: 2.0A max.

Physical

Contact: Copper Alloy
Plating: Tin over Nickel
Insulation Diameter: 1.20mm dia. max.
Strip Length: 1.50 to 1.90mm
Wire Gauge: 24 to 28 AWG

1.50mm (.059") Pitch CLI-K-Mate™ Wire-to-Board Housing

502578

Single Row
Positive Lock

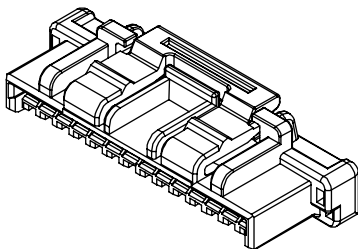

Features and Benefits

- Sizes 2 to 15 circuits
- Audible "click," low insertion force and secure mating
- Tuning fork style contact design secures contact and avoids terminal stubbing

Reference Information

Product Specification: PS-502584-001
Packaging: Bag
Mates With: 502584, 502585
Use With: 502579 terminal
Designed In: Millimeters

Electrical

Voltage: 100V max.
Current: 2.0A max.
Contact Resistance: 20 milliohms max.
Dielectric Withstanding Voltage: 500V AC/1 min.
Insulation Resistance: 500 Megohms min.

Physical

Housing: PBT, UL 94V-0

Circuits	Order No.	Lead-free
2	502578-0200	Yes
3	502578-0300	
4	502578-0400	
5	502578-0500	
6	502578-0600	
7	502578-0700	
8	502578-0800	

Circuits	Order No.	Lead-free
9	502578-0900	Yes
10	502578-1000	
11	502578-1100	
12	502578-1200	
13	502578-1300	
14	502578-1400	
15	502578-1500	

Note: 2-5 circuits has single lock and 6-15 circuits has dual locks. See drawings for details.

1.50mm (.059") Pitch CLIK-Mate™ Wire-to-Board PCB Receptacle

502584
Single Row
Vertical

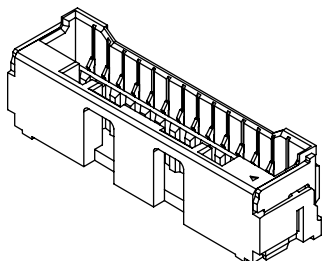

Features and Benefits

- Sizes 2 to 15 circuits
- Audible "click," low insertion force and secure mating
- Tuning fork style contact design secures contact and avoids terminal stubbing
- Reinforced metal solder tabs enable housing wall support and secure PCB retention

Reference Information

Product Specification: PS-502584-001
Packaging: Embossed tape
Mates With: 502578
Designed In: Millimeters

Electrical

Voltage: 100V max.
Current: 2.0A max.
Contact Resistance: 20 milliohms max.
Dielectric Withstanding Voltage: 500V AC/1 min.
Insulation Resistance: 500 Megohms min.

Physical

Housing: Heatproof resin, UL 94V-0
Contact: Copper Alloy
Plating: Tin over Nickel
Fitting Nail: Copper Alloy, Tin over Nickel plating

Circuits	Order No.	Lead-free
2	502584-0270	Yes
3	502584-0370	
4	502584-0470	
5	502584-0570	
6	502584-0670	
7	502584-0770	
8	502584-0870	

Circuits	Order No.	Lead-free
9	502584-0970	Yes
10	502584-1070	
11	502584-1170	
12	502584-1270	
13	502584-1370	
14	502584-1470	
15	502584-1570	

Note: 2-5 circuits has single lock and 6-15 circuits has dual locks. See drawings for details.

1.50mm (.059") Pitch CLIK-Mate™ Wire-to-Board PCB Receptacle

502585
Single Row
Right Angle

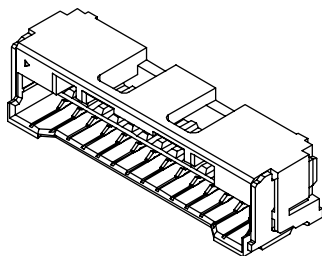

Features and Benefits

- Sizes 2 to 15 circuits
- Audible "click," low insertion force and secure mating
- Tuning fork style contact design secures contact and avoids terminal stubbing
- Reinforced metal solder tabs enable housing wall support and secure PCB retention
- Flat area for pick-and-place is provided

Reference Information

Product Specification: PS-502584-001
Packaging: Embossed tape
Mates With: 502578
Designed In: Millimeters

Electrical

Voltage: 100V max.
Current: 2.0A max.
Contact Resistance: 20 milliohms max.
Dielectric Withstanding Voltage: 500V AC/1 min.
Insulation Resistance: 500 Megohms min.

Physical

Housing: Heatproof resin, UL 94V-0
Contact: Copper Alloy
Plating: Tin over Nickel
Fitting Nail: Copper Alloy, Tin over Nickel plating

Circuits	Order No.	Lead-free
2	502585-0270	Yes
3	502585-0370	
4	502585-0470	
5	502585-0570	
6	502585-0670	
7	502585-0770	
8	502585-0870	

Circuits	Order No.	Lead-free
9	502585-0970	Yes
10	502585-1070	
11	502585-1170	
12	502585-1270	
13	502585-1370	
14	502585-1470	
15	502585-1570	

Note: 2-5 circuits has single lock and 6-15 circuits has dual locks. See drawings for details.

1.50mm (.059") Pitch Plateau HS Dock™ High Speed Docking Connectors

75018/75019/75140
Right Angle Plug
Right Angle Receptacle
Vertical Plug

Features and Benefits

- Metal-plated plastic housing provides shielding for very low crosstalk and supports signal speeds in excess of 10 Gbps
- Insert molded wafers for controlled impedance within plated signal channels
- Various offset heights (from top of PCB) provide application design flexibility
- Four levels of mating and guide features support hot pluggable applications, ensure proper mating and provide first-mate/last-break
- RoHS Level 5 compliant

Reference Information

Product Specification: PS-75018-001
Packaging: Tray
UL File No.: E29179
CSA File No.: 1373502
Designed In: Millimeters

Electrical

Voltage: 12V DC
Current: 2.75A
Contact Resistance: 30 milliohms max.
Dielectric Withstanding Voltage: 500V AC
Insulation Resistance: 1,000 Megohms min.

Mechanical

Insertion Force to PCB: 35N max. per compliant pin
Retention Force to PCB: 9N max. per compliant pin
Mating Force: 80N max.
Unmating Force: 20N min.
Durability: 100 cycles

Physical

Housing: Liquid Crystal Polymer, UL 94V-0
Contact: Copper Alloy
Plating: Contact Area—30µ" min. Select Gold
Tail Area—Tin/Lead
Underplating: Nickel
PCB Thickness: 1.80mm (.071")

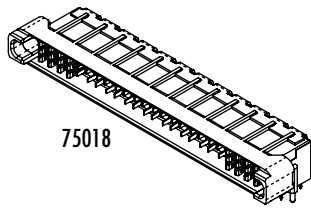

75018

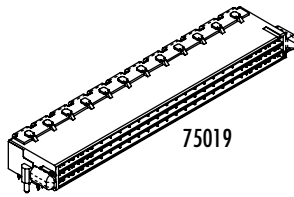

75019

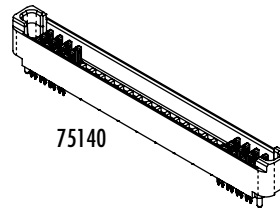

75140

Right Angle Plug

Circuits	Order No.	Centerline Height	Height	Length	Lead-free
144	75018-0021	4.74 (.187)	9.78 (.385)	96.50 (3.799)	RoHS compliant by exemption
	75018-0022	5.74 (.226)	10.78 (.424)		
	75018-0023	8.74 (.334)	13.78 (.543)		
108	75018-0024	4.74 (.187)	9.78 (.385)	75.50 (2.972)	
	75018-0025	8.74 (.334)	13.78 (.543)		
120	75018-0026	4.74 (.187)	9.78 (.385)	82.50 (3.248)	
108	75018-0027	5.74 (.226)	10.78 (.424)	75.50 (2.972)	
120	75018-0029			82.50 (3.248)	

Right Angle Receptacle

Circuits	Order No.	Centerline Height	Height	Length	Lead-free
108	75019-0013	4.74 (.187)	9.98 (.393)	72.50 (2.854)	RoHS compliant by exemption
120	75019-0014			79.50 (3.130)	
144	75019-0015			6.09 (.240)	
	75019-0016	72.50 (2.854)			
108	75019-0017				

Vertical Plug

Circuits	Order No.	Centerline Height	Height	Length	Lead-free
144	75140-0012	N / A	10.07 (.396)	96.50 (3.799)	RoHS compliant by exemption

1.50mm (.059") Pitch Plateau HS Dock™ High Speed Docking Connectors Interposer Plug

75126

Elevated, Right Angle

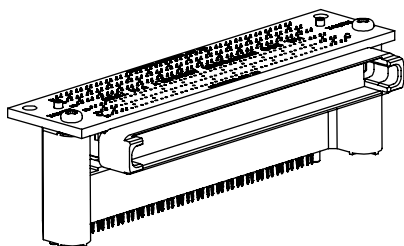

Features and Benefits

- Plateau HS Dock plug raised to stack above a standard, right angle plug on the PCB
- Metal-plated plastic housing provides shielding for very low crosstalk and supports signal speeds in excess of 10 Gbps
- Insert molded wafers for controlled impedance within plated signal channels
- Four levels of mating and guide features support hot pluggable applications, ensure proper mating and provide first-mate/last-break
- RoHS Level 5 compliant

Reference Information

Product Specification: PS-75018-001
Packaging: Tray
UL File No.: E29179
CSA File No.: 1373502
Designed In: Millimeters

Electrical

Voltage: 12V DC
Current: 2.75A
Contact Resistance: 30 milliohms max.
Dielectric Withstanding Voltage: 500V AC
Insulation Resistance: 1,000 Megohms min.

Mechanical

Insertion Force to PCB: 35N max. per compliant pin
Retention Force to PCB: 9N max. per compliant pin
Mating Force: 80N max.
Unmating Force: 20N min.
Durability: 100 cycles

Physical

Housing: Liquid Crystal Polymer, UL 94V-0
Contact: Copper Alloy
Plating: Contact Area—30µ" min. Select Gold
Tail Area—Tin/Lead
Underplating: Nickel
PCB Thickness: 1.80mm (.071")

Circuits	Order No.	Centerline Height	Total Height	Total Length	Lead-free
144	75126-1003	24.26 (.955)	32.80 (1.291)	111.50 (4.390)	RoHS compliant by exemption
	75126-2001	20.26 (.798)			

1.50mm (.059") Pitch Plateau HS Dock™ PG (Power and Guide) High Speed Docking Connectors

75475/75476

**Right Angle Plug
Right Angle Receptacle**

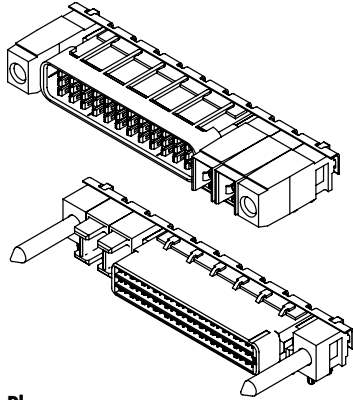

Plug

Circuits	Order No.	No. of Power Modules	No. of Guide Modules	Total Length	Lead-free
72	75475-1004	2	2	79.50 (3.130)	RoHS compliant by exemption
		*Orientation: Guide—72 signal—2 power—Guide			
144	75475-1005	6	2	156.50 (6.161)	
		*Orientation: Guide—72 signal—2 power—72 signal—2 power—Guide—2 power			
108	75475-1006	3	2	107.5 (4.232)	
		Orientation: Guide—3 power—108 signal—Guide			
144	75475-1007	2	2	121.5 (4.783)	
		Orientation: Guide—2 power—144 signal—Guide			
108	75475-1008	3	2	107.5 (4.232)	
		Orientation: Guide—3 power—108 signal—Guide			

Receptacle

Circuits	Order No.	No. of Power Modules	No. of Guide Modules	Total Length	Lead-free
72	75476-1004	2	2	79.50 (3.130)	RoHS compliant by exemption
		*Orientation: Guide—72 signal—2 power—Guide			
144	75476-1005	6	2	156.50 (6.161)	
		*Orientation: 2 power—Guide—2 power—72 signal—2 power—72 signal—Guide			
108	75476-1006	3	2	107.5 (4.232)	
		*Orientation: Guide—108 signal—3 power—Guide			
144	75476-1007	2	2	121.5 (4.783)	
		*Orientation: Guide—144 signal—2 power—Guide			
108	75476-1008	3	2	107.5 (4.232)	
		*Orientation: Guide—108 signal—3 power—Guide			

* Orientation is associated from the inter-mating face, moving left to right

Features and Benefits

- Metal-plated plastic housing provides shielding for very low crosstalk and supports signal speeds in excess of 10Gbps
- Insert molded wafers for controlled impedance within plated signal channels
- Robust guide pins to aid in blind mating
- Separate power modules to carry currents of up to 20.0A
- Rigid stiffener holds modules in place for customer specific configurations
- Four levels of mating and guide features support hot pluggable applications, ensure proper mating and provide first-mate/last-break
- RoHS Level 5 compliant

Reference Information

Product Specification: PS-75018-001
 Packaging: Tray
 UL File No.: E29179
 CSA File No.: 1373502
 Designed In: Millimeters

Electrical

Voltage: 12V DC
 Current (signal wafer): 2.75A
 Current (power module): 20A
 Contact Resistance: 30 milliohms max.
 Dielectric Withstanding Voltage: 500V AC
 Insulation Resistance: 1,000 Megohms min.

Mechanical

Insertion Force to PCB: 35N max. per compliant pin
 Retention Force to PCB: 9N max. per compliant pin
 Mating Force: 80N max.
 Unmating Force: 20N min.
 Durability: 100 cycles

Physical

Housing: Liquid Crystal Polymer, UL 94V-0
 Contact: Copper Alloy
 Plating: Contact Area—30µ" min. Select Gold
 Tail Area—Tin/Lead
 Underplating: Nickel
 PCB Thickness: 1.80mm (.071")

1.50mm (.059") Pitch Pico-SPOX™ Wire-to-Board Crimp Terminal

87421

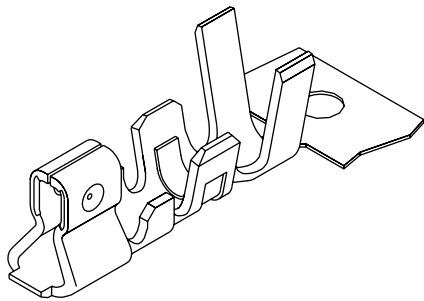

Order No.	Lead-free
87421-0000	Yes

Features and Benefits

- Low profile
- Locking tang snaps into housing window for secure retention
- Dual-point contact design
- Anti-fishhooking box design protects contact area

Reference Information

Packaging: Reel
Wire Style: UL1061
CSA File No.: LR19980A
Use With: 87439 housing
Designed In: Millimeters

Electrical

Voltage: 30V max.

Current:

AWG	24	26
	3.0A	2.0A

Contact Resistance: 40 milliohms max.
Dielectric Withstanding Voltage: 500V AC/1 min.
Insulation Resistance: 1000 Megohms min.

Physical

Contact: Phosphor Bronze
Plating: Tin
Wire Range: 24, 26, 28, 30 AWG
Insulation Diameter: 1.10mm dia. max.

www.molex.com/customer.html?seriesNumber=87421

1.50mm (.059") Pitch Pico-SPOX™ Wire-to-Board Header

87437

Vertical, SMT
Shrouded

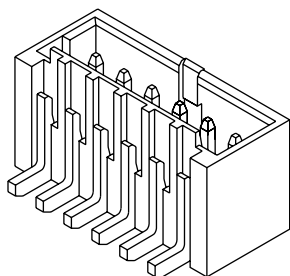

Features and Benefits

- Sizes 2 to 15 circuits
- Compact, low-profile SMT design
- Fully shrouded to protect pins during mating/unmating
- Center keyway for secure connection to housing
- One-piece mating post and SMT tail provides coplanarity control and large soldering area
- High-temperature material withstands reflow soldering

Reference Information

Product Specification: PS-87437
Packaging: Tube or tape and reel
UL File No.: E29179
CSA File No.: LR19980A
Mates With: 87439 housing
Designed In: Millimeters

Electrical

Voltage: 350V max.

Current: 3.0A max.

Contact Resistance: 40 milliohms max.
Dielectric Withstanding Voltage: 500V AC/1 min.
Insulation Resistance: 1000 Megohms min.

Physical

Housing: Beige glass-filled Nylon, UL 94V-0
Contact: Brass Alloy
Plating: Tin over Nickel

Circuits	Order No.		Lead-free
	Tube	Tape and Reel	
2	87437-0242	87437-0243	Yes
3	87437-0342	87437-0343	
4	87437-0442	87437-0443	
5	87437-0542	87437-0543	
6	87437-0642	87437-0643	
7	87437-0742	87437-0743	
8	87437-0842	87437-0843	

Circuits	Order No.		Lead-free
	Tube	Tape and Reel	
9	87437-0942	87437-0943	Yes
10	87437-1042	87437-1043	
11	87437-1142	87437-1143	
12	87437-1242	87437-1243	
13	87437-1342	87437-1343	
14	87437-1442	87437-1443	
15	87437-1542	87437-1543	

1.50mm (.059") Pitch Pico-SPOX™ Wire-to-Board Housing

87439

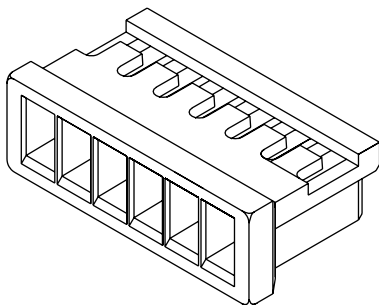

Features and Benefits

- Sizes 2 to 15 circuits
- Standard with center locking ramp
- Locking windows secure terminal to housing
- Lead-in chamfer facilitates mating

Reference Information

Product Specification: PS-87437
 Packaging: Bag
 UL File No.: E29179
 CSA File No.: LR19980A
 Mates With: 87437 and 87438 headers
 Use With: 87421 crimp terminal
 Designed In: Millimeters

Physical

Housing: Nylon, UL 94V-0

Circuits	Order No.
2	87439-0200
3	87439-0300
4	87439-0400
5	87439-0500
6	87439-0600
7	87439-0700
8	87439-0800

Circuits	Order No.
9	87439-0900
10	87439-1000
11	87439-1100
12	87439-1200
13	87439-1300
14	87439-1400
15	87439-1500

www.molex.com/customer.html?seriesNumber=87439

1.50mm (.059") Pitch Pico-SPOX™ Wire-to-Board Header

87438

**Right Angle, SMT
Shrouded**

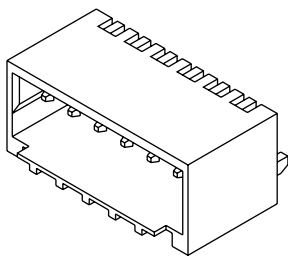

Features and Benefits

- Sizes 2 to 15 circuits
- Compact, low-profile SMT design
- Fully shrouded to protect pins during mating/unmating
- Center keyway for secure connection to housing
- One-piece mating post and SMT tail provides coplanarity control and large soldering area
- High-temperature material withstands reflow soldering

Reference Information

Product Specification: PS-87437
 Packaging: Tube or tape and reel
 UL File No.: E29179
 CSA File No.: LR19980A
 Mates With: 87439 housing
 Designed In: Millimeters

Electrical

Voltage: 350V max.
 Current: 3.0A max.
 Contact Resistance: 40 milliohms max.
 Dielectric Withstanding Voltage: 500V AC/1 min.
 Insulation Resistance: 1000 Megohms min.

Physical

Housing: Beige glass-filled Nylon, UL 94V-0
 Contact: Brass Alloy
 Plating: Tin over Nickel

Circuits	Order No.		Lead-free
	Tube	Tape and Reel	
2	87438-0242	87438-0243	Yes
3	87438-0342	87438-0343	
4	87438-0442	87438-0443	
5	87438-0542	87438-0543	
6	87438-0642	87438-0643	
7	87438-0742	87438-0743	
8	87438-0842	87438-0843	

Circuits	Order No.		Lead-free
	Tube	Tape and Reel	
9	87438-0942	87438-0943	Yes
10	87438-1042	87438-1043	
11	87438-1142	87438-1143	
12	87438-1242	87438-1243	
13	87438-1342	87438-1343	
14	87438-1442	87438-1443	
15	87438-1542	87438-1543	

1.60mm (.062") Pitch Board-to-Board Receptacle

52712 Right Angle Detachable

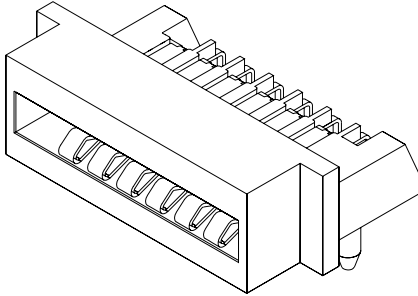

Circuits	Order No.	Lead-free
12	52712-1219	Yes

Features and Benefits

- Size 12 circuits
- Pull tab on housing for easy mating/unmating
- PCB locking pegs

Reference Information

Mates With: 53440 plug
Designed In: Millimeters

Electrical

Voltage: 125V
Current: 1.0A max.
Contact Resistance: 35 milliohms max.
Dielectric Withstanding Voltage: 500V AC/1 min.
Insulation Resistance: 500 Megohms min.

Physical

Housing: PBT, UL 94V-0
Contact: Phosphor Bronze
Plating: Gold on contacts and Tin on solder tails

2.00 TO 2.50MM (.079 TO .098") PITCH PCB and Wire Connectors

C

2.00mm (.079") Pitch Connectors

Dual Row Wire-to-Board, Flex-to-Board and Board-to-Board Connectors — Milli-Grid™	C-2 to C-13
Single/Dual Row Multi-Harness Wire-to-Wire and Wire-to-Board Connectors — Mi II™	C-14 to C-20
Dual Row Wire-to-Board Connectors — iGrid™	C-21 to C-22
Single Row Wire-to-Board Connectors — CLIK-Mate™	C-23 to C-24
Product Matrices	C-25, C-33
Wire-to-Wire Connectors	C-26 to C-27
Wire-to-Board Connectors — Micro-Latch™	C-28 to C-29
Wire-to-Board Connectors	C-30 to C-31
Wire-to-Board Connectors — Sherlock™	C-31 to C-32
Wire-to-Board Connectors — MicroBlade™	C-34 to C-36
Wire-to-Board Connectors	C-36 to C-38
Board-In Connectors	C-38 to C-40
Board-to-Board Connectors	C-41
Dual Row Custom Headers	C-42
Pogo Pin Connector	C-43

2.50mm (.098") Pitch Connectors

Product Matrices	C-44, C-51, C-61, C-66
Wire-to-Board and Wire-to-Wire Connectors — SPOX™ and SPOX BMI™	C-45 to C-50
Wire-to-Wire Connectors — KK®	C-50
Wire-to-Wire and Wire-to-Board Connectors	
Mini-Latch™	C-52 to C-53
Mini-Lock™	C-54 to C-60
Wire-to-Wire Connectors	C-62 to C-63
Board-In Connectors	C-63 to C-65
Wire-to-Board Connectors	C-67 to C-68
IDT Connectors — Appli-Mate™	C-69

Visit www.molex.com to access more part numbers and product information, download sales drawings, product specifications, 3D models, place sample requests, and more.

2.00mm (.079") Pitch Milli-Grid™

Introduction

Molex's Milli-Grid family of high density connectors is based on a 2.00 x 2.00mm grid pattern. The system offers complete design flexibility for wire-to-board, board-to-board and cable-to-board connections in PC, consumer, telecom and other electronic industries.

Compared to traditional 2.54mm (.100") pitch connectors, Milli-Grid connectors offer up to 40% savings in PCB real estate.

The Milli-Grid family includes crimp terminals, housings, headers and receptacles. The crimp terminals feature an early entry design that provides longer wiping action for more reliable contact. The receptacles boast a choice of mating styles in top, side and bottom entry in PCB, IDT and FPC versions. Headers are available in both shrouded and unshrouded styles.

The 2.00mm Advantage

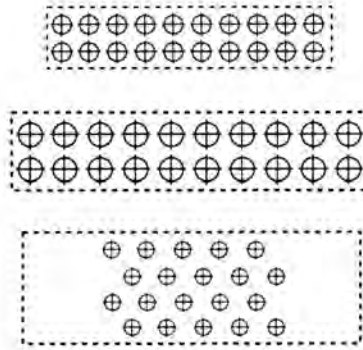

(Milli-Grid vs. 2.54 and 1.27mm Pitch)
20-Circuit PCB Usage Comparison

Milli-Grid = 80mm²

2.54mm Pitch = 125mm²

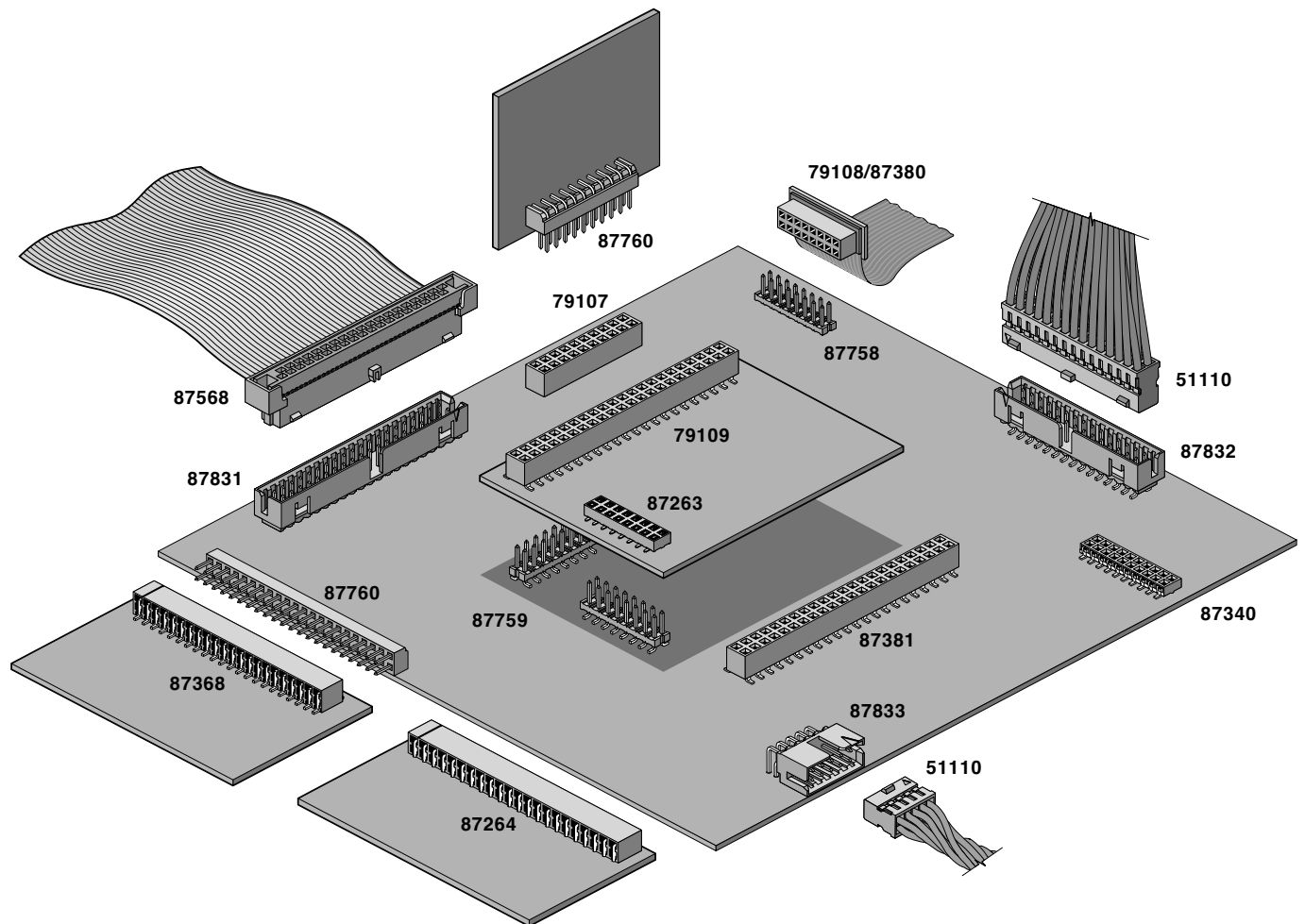

1.27mm Pitch = 185mm²

Application Overview

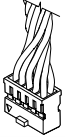
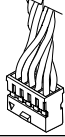

Milli-Grid™ 2.00mm (.079") Pitch Interconnection System Wire-to-Board System

Early Entry System Terminal			
	Order No.	Packaging	Plating
	50394-8051	Reel	15µ" min. Select Gold
	50394-8100	Bag	15µ" min. Select Gold
	50394-8052	Reel	30µ" min. Select Gold
	50394-8200	Bag	30µ" min. Select Gold

Crimp Housings			
	Circuits	Order No.	Features
	4 to 32	51110-XX50	Plain
	8 to 12	51110-XX51	Center Polarization Key
	4 to 12	51110-XX60	Center Polarization Ramp
	14 to 32	51110-XX51	Locking Ramp and Polarization Key

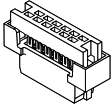
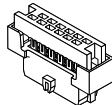
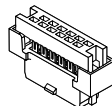
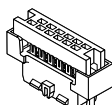
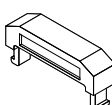
IDT Housings and Strain Relief			
	10, 12, 14, 16, 20, 22, 24, 26, 30, 34, 40, 44 and 50	87568-XX63	Plain Front 15µ" Gold
		87568-XX64	Plain Front 30µ" Gold
	14, 16, 20, 22, 24, 26, 30, 34, 40, 44 and 50	87568-XX43	Center Polarization Ramp 15µ" Gold
		87568-XX44	Center Polarization Ramp 30µ" Gold
	10 and 12	87568-XX73	Center Locking Ramp 15µ" Gold
		87568-XX74	Center Locking Ramp 30µ" Gold
	14, 16, 20, 22, 24, 26, 30, 34, 40, 44 and 50	87568-XX93	Locking Ramp and Polarization Key 15µ" Gold
		87568-XX94	Locking Ramp and Polarization Key 30µ" Gold
	10, 12, 14, 16, 20, 22, 24, 26, 30, 34, 40, 44 and 50	87569-10XX	Strain Relief

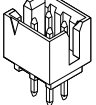
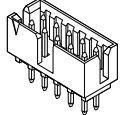
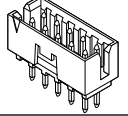
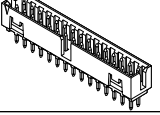
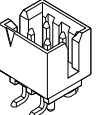
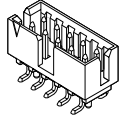
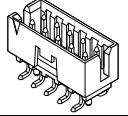
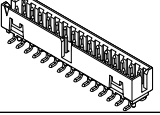
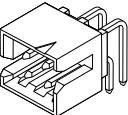
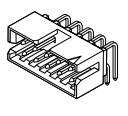
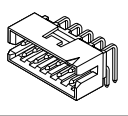
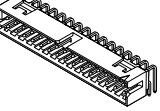
Shrouded Headers			
Through Hole	Circuits	Order No.	Features
	4 to 6	87831-XX20	Plain 15µ" Gold
		87831-XX21	Plain 30µ" Gold
	8 to 12	87831-XX20	Center Polarization Slot 15µ" Gold
		87831-XX21	Center Polarization Slot 30µ" Gold
	4 to 12	87831-XX41	Center Locking Window 15µ" Gold
		87831-XX42	Center Locking Window 30µ" Gold
	14 to 50	87831-XX20	Center Polarization Slot and Locking Window 15µ" Gold
		87831-XX21	Center Polarization Slot and Locking Window 30µ" Gold
SMT			
	4 to 6	87832-XX20	Plain 15µ" Gold
		87832-XX21	Plain 30µ" Gold
	8 to 12	87832-XX20	Center Polarization Slot 15µ" Gold
		87832-XX21	Center Polarization Slot 30µ" Gold
	4 to 12	87832-XX10	Center Locking Window 15µ" Gold
		87832-XX11	Center Locking Window 30µ" Gold
	14 to 50	87832-XX20	Center Polarization Slot and Locking Window 15µ" Gold
		87832-XX21	Center Polarization Slot and Locking Window 30µ" Gold
Right Angle			
	4 to 6	87833-XX20	Plain 15µ" Gold
		87833-XX21	Plain 30µ" Gold
	8 to 12	87833-XX20	Center Polarization Slot 15µ" Gold
		87833-XX21	Center Polarization Slot 30µ" Gold
	4 to 12	87833-XX31	Center Locking Window 15µ" Gold
		87833-XX32	Center Locking Window 30µ" Gold
	14 to 50	87833-XX20	Center Polarization Slot and Locking Window 15µ" Gold
		87833-XX21	Center Polarization Slot and Locking Window 30µ" Gold

C
2.00 to 2.50mm (.079 to .098") Pitch PCB and Wire Connectors

Milli-Grid™ 2.00mm (.079") Pitch Interconnection System Board-to-Board System

2.00 to 2.50mm (.079 to .098") Pitch PCB and Wire Connectors

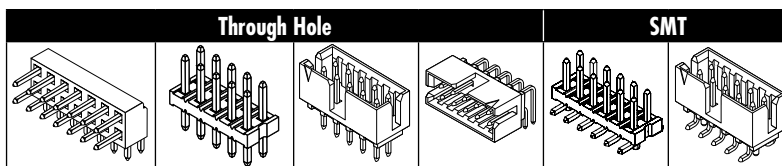

				Through Hole			SMT		
				Series/Description					
				87760 Right Angle	87758 Vertical	87831 Vertical	87833 Right Angle	87759 Vertical	87832 Vertical
	Series	Description	Contact Point	Overall Height	Circuits	Overall Mating Heights			
Through Hole									
	79107	Top Entry	1.50 (.059)	4.44 (.175)	4 to 50	6.94 (.273)	6.94 (.273)	7.14 (.281)	8.14 (.320)
	87264	Side Entry	1.50 (.059)	4.00 (.157) by 5.00 (.197)	8 to 50			7.70 (.303)	
SMT									
	79109	Top/Bottom Entry	1.50 (.059)	4.65 (.183)	4 to 50	7.15 (.281)	7.15 (.281)	7.35 (.289)	8.35 (.329)
	87263	Bottom Entry	1.30 (.051)	2.80 (.110)	4 to 44			7.08 (.279)	
	87340	Top Entry	0.90 (.035)	2.15 (.085)	4 to 20			4.85 (.191)	
	87381	Top Entry	1.70 (.067)	4.50 (.177)	6 to 50	7.00 (.276)	7.00 (.276)	7.20 (.283)	8.20 (.323)
	87368	Side Entry	1.50 (.059)	4.90 (.193) by 5.00 (.197)	8 to 50			7.70 (.303)	

Unshrouded Headers					
	Order No.	Circuits	Features	Mating Length	Tail Length
	87758-XX16	4 to 50	15µ" Gold	4.00 (.158)	2.60 (.102)
	87758-XX17		30µ" Gold		
	87759-XX50	8 to 50	With Pegs 15 Gold	3.80 (.150)	1.20 (.047)
	87759-XX51		With Pegs 30µ" Gold		
	87759-XX14	Without Pegs 15µ" Gold			
	87759-XX15	Without Pegs 30µ" Gold			
	87760-XX16	4 to 50	15µ" Gold	4.00 (.158)	2.60 (.102)
	87760-XX17		30µ" Gold		

2.00mm (.079") Pitch Milli-Grid™ Crimp Terminal

50394

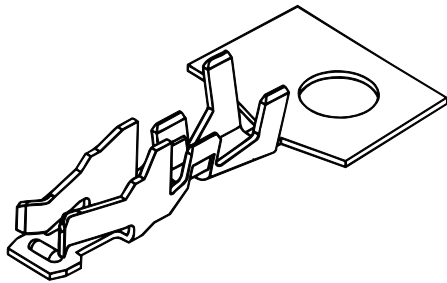

Order No.	AWG	Plating	Lead-free
50394-8051	26 - 30	15µ" min. selective Gold	Yes
50394-8052		30µ" min. selective Gold	

Features and Benefits

- Early entry terminal design for superior contact

Reference Information

Product Specification: PS-51110-001
 Packaging: Reel
 UL File No.: E29179
 CSA File No.: LR19980
 Mates With: 0.50mm square pins
 Use With: 51110
 Designed In: Millimeters

Electrical

Voltage: 125V
 Current:

AWG	24	26	28	30
	2.0A	1.5A	1.0A	0.5A

Contact Resistance: 40 milliohms max.
 Dielectric Withstanding Voltage: 500V
 Insulation Resistance: 1000 Megohms min.

Mechanical

Contact Insertion Force: 9.8N max.
 Mating Force: 1.96N per circuit max.
 Unmating Force: 0.392N per circuit min.

Physical

Contact: Phosphor Bronze
 Plating: See Table
 Wire Range: 26 to 30 AWG
 Insulation Range: 1.40mm dia. max.

2.00mm (.079") Pitch Milli-Grid™ Crimp Housing

51110

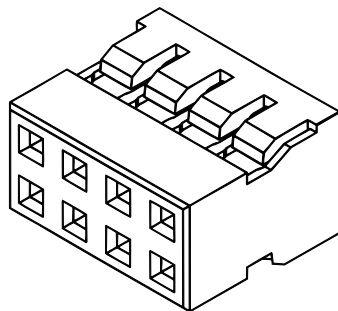

Features and Benefits

- Sizes 4 to 32 circuits
- Front latches for added retention forces after mating
- Options include center polarization key and front latches version (14 to 32 circuits only), center polarization key only (8 to 12 circuits)

Reference Information

Product Specification: PS-51110
 Packaging: Bag
 UL File No.: E29179
 CSA File No.: LR19980
 Mates With: 87831, 87832, 87833, 87858, 87859, 87760
 Use With: 50394
 Designed In: Millimeters

Physical

Housing: Black glass-filled polyester, UL 94V-0

Circuits	Order No.	
	Plain	With Polarization Keys
4	51110-0450	51110-0460
6	51110-0650	51110-0660
8	51110-0850	51110-0860
10	51110-1050	51110-1060
12	51110-1250	51110-1260
14	51110-1450	51110-1451
16	51110-1650	51110-1651
18	51110-1850	51110-1851

Circuits	Order No.	
	Plain	With Polarization Keys
20	51110-2050	51110-2051
22	51110-2250	51110-2251
24	51110-2450	51110-2451
26	51110-2650	51110-2651
28	51110-2850	51110-2851
30	51110-3050	51110-3051
32	51110-3250	51110-3251

2.00mm (.079") Pitch Milli-Grid™ Board-to-Board Receptacle

79107 Vertical, Dual Row Through Hole

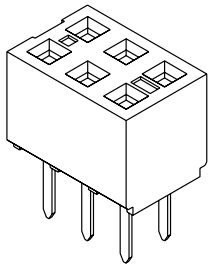

Circuits	Order No.		Lead-free
	PC Tail Length = 3.00mm (.118")		
	15µ" Select Gold	30µ" Select Gold	
4	79107-7001	79107-7051	Yes
6	79107-7002	79107-7052	
8	79107-7003	79107-7053	
10	79107-7004	79107-7054	
12	79107-7005	79107-7055	
14	79107-7006	79107-7056	
16	79107-7007	79107-7057	
18	79107-7008	79107-7058	

Features and Benefits

- Sizes 4 to 50 circuits
- IR, vapor-phase and wave solder Surface Mount Compatible
- Dual beam contact design ensures reliable electrical performance
- Molded-in void locations offered for polarization to mating connector
- PC tails have tapered lead-in on for ease of insertion into the PC board
- Also available with shortened 1.91mm (.075") tail length for 0.79mm (.031") thick PC boards

Reference Information

Product Specification: PS-79107
 Packaging: Tube
 UL File No.: E29179
 CSA File No.: LR19980
 Mates With: 0.50mm square pin headers 87760, 87758, 87759 and 87762
 Designed In: Millimeters

Electrical

Voltage: 125V
 Current: 1.0A
 Contact Resistance: 25 milliohms max.
 Dielectric Withstanding Voltage: 1250V
 Insulation Resistance: 1000 Megohms min.

Mechanical

Mating Force: 8 oz max.
 Unmating Force: 1.5 oz min.
 Normal Force: 100g
 Durability: 15µ" Gold contacts—50 cycles min.
 30µ" Gold contacts—100 cycles min.

Physical

Housing: Black glass-filled LCP, UL 94V-0
 Contact: Phosphor Bronze
 Plating: See Table

Circuits	Order No.		Lead-free
	PC Tail Length = 3.00mm (.118")		
	15µ" Select Gold	30µ" Select Gold	
20	79107-7009	79107-7059	Yes
22	79107-7010	79107-7060	
24	79107-7011	79107-7061	
26	79107-7012	79107-7062	
28	79107-7013	79107-7063	
30	79107-7014	79107-7064	
32	79107-7015	79107-7065	
34	79107-7016	79107-7066	

Circuits	Order No.		Lead-free
	PC Tail Length = 3.00mm (.118")		
	15µ" Select Gold	30µ" Select Gold	
36	79107-7017	79107-7067	Yes
38	79107-7018	79107-7068	
40	79107-7019	79107-7069	
42	79107-7020	79107-7070	
44	79107-7021	79107-7071	
46	79107-7022	79107-7072	
48	79107-7023	79107-7073	
50	79107-7024	79107-7074	

2.00mm (.079") Pitch Milli-Grid™ Board-to-Board Receptacle

79109 Vertical, Dual Row Top/Bottom Entry SMT, with Pegs

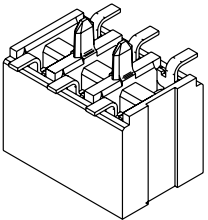

Circuits	Order No.				Lead-free
	15µ" Gold		30µ" Gold		
	Tube	Tape and Reel	Tube	Tape and Reel	
4	79109-1201	*	79109-1251	*	Yes
6	79109-1202	79109-8602	79109-1252	79109-8652	
8	79109-1203	79109-8603	79109-1253	79109-8653	
10	79109-1204	79109-8604	79109-1254	79109-8654	
12	79109-1205	79109-8605	79109-1255	79109-8655	
14	79109-1206	79109-8606	79109-1256	79109-8656	
16	79109-1207	79109-8607	79109-1257	79109-8657	
18	79109-1208	79109-8608	79109-1258	79109-8658	
20	79109-1209	79109-8609	79109-1259	79109-8659	
22	79109-1210	79109-8610	79109-1260	79109-8660	
24	79109-1211	79109-8611	79109-1261	79109-8661	
26	79109-1212	79109-8612	79109-1262	79109-8662	

Features and Benefits

- Sizes 4 to 50 circuits
- Dual beam contact design ensures reliable electrical performance
- Molded-in void locations offered for polarization to mating connector
- Can be used as either a top or bottom entry receptacle
- Pegs offer press-fit retention to PC board

Reference Information

Product Specification: PS-79107
 Packaging: Tube or tape and reel
 UL File No.: E29179
 CSA File No.: LR19980
 Mates With: 0.50mm square pin headers 87760, 87758, 87759 and 87762
 Designed In: Millimeters

Electrical

Voltage: 125V
 Current: 1.0A
 Contact Resistance: 25 milliohms max.
 Dielectric Withstanding Voltage: 1250V
 Insulation Resistance: 1000 Megohms min.

Mechanical

Mating Force: 8 oz max.
 Unmating Force: 1.5 oz min.
 Normal Force: 100g
 Durability: 15µ" Gold contacts—50 cycles min.
 30µ" Gold contacts—100 cycles min.

Physical

Housing: Black glass-filled LCP, UL 94V-0
 Contact: Phosphor Bronze
 Plating: See Table

Circuits	Order No.				Lead-free
	15µ" Gold		30µ" Gold		
	Tube	Tape and Reel	Tube	Tape and Reel	
28	79109-1213	79109-8613	79109-1263	79109-8663	Yes
30	79109-1214	79109-8614	79109-1264	79109-8664	
32	79109-1215	79109-8615	79109-1265	79109-8665	
34	79109-1216	79109-8616	79109-1266	79109-8666	
36	79109-1217	79109-8617	79109-1267	79109-8667	
38	79109-1218	79109-8618	79109-1268	79109-8668	
40	79109-1219	79109-8619	79109-1269	79109-8669	
42	79109-1220	79109-8620	79109-1270	79109-8670	
44	79109-1221	79109-8621	79109-1271	79109-8671	
46	79109-1222	79109-8622	79109-1272	79109-8672	
48	79109-1223	79109-8623	79109-1273	79109-8673	
50	79109-1224	79109-8624	79109-1274	79109-8674	

* Contact Molex

2.00mm (.079") Pitch Milli-Grid™ Board-to-Board Receptacle

79109

**Vertical, Dual Row
Top/Bottom Entry
SMT, without Pegs**

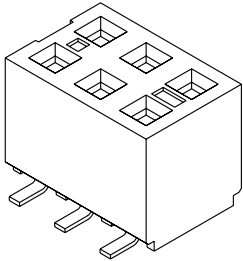

Features and Benefits

- Sizes 4 to 50 circuits
- Dual beam contact design ensures reliable electrical performance
- Molded-in void locations offered for polarization to mating connector
- Can be used as either top or bottom entry receptacle

Reference Information

Product Specification: PS-79107
 Packaging: Tube or tape and reel
 UL File No.: E29179
 CSA File No.: LR19980
 Mates With: 0.50mm square pin headers 87760, 87758, 87759 and 87762
 Designed In: Millimeters

Electrical

Voltage: 125V
 Current: 1.0A
 Contact Resistance: 15 milliohms max.
 Dielectric Withstanding Voltage: 500V
 Insulation Resistance: 1000 Megohms min.

Mechanical

Mating Force: 2.22N (.50 lb) max.
 Unmating Force: 0.42N (.09 lb) min.
 Normal Force: 0.98N (.22 lb)
 Durability: 15μ" Gold contacts—50 cycles min.
 30μ" Gold contacts—100 cycles min.

Physical

Housing: Black glass-filled LCP, UL 94V-0
 Contact: Phosphor Bronze
 Plating: See Table

Circuits	Order No.				Lead-free
	15μ" Gold		30μ" Gold		
	Tube	Tape and Reel	Tube	Tape and Reel	
4	79109-1001	*	79109-1051	*	Yes
6	79109-1002	79109-8402	79109-1052	79109-8452	
8	79109-1003	79109-8403	79109-1053	79109-8453	
10	79109-1004	79109-8404	79109-1054	79109-8454	
12	79109-1005	79109-8405	79109-1055	79109-8455	
14	79109-1006	79109-8406	79109-1056	79109-8456	
16	79109-1007	79109-8407	79109-1057	79109-8457	
18	79109-1008	79109-8408	79109-1058	79109-8458	
20	79109-1009	79109-8409	79109-1059	79109-8459	
22	79109-1010	79109-8410	79109-1060	79109-8460	
24	79109-1011	79109-8411	79109-1061	79109-8461	
26	79109-1012	79109-8412	79109-1062	79109-8462	

Circuits	Order No.				Lead-free
	15μ" Gold		30μ" Gold		
	Tube	Tape and Reel	Tube	Tape and Reel	
28	79109-1013	79109-8413	79109-1063	79109-8463	Yes
30	79109-1014	79109-8414	79109-1064	79109-8464	
32	79109-1015	79109-8415	79109-1065	79109-8465	
34	79109-1016	79109-8416	79109-1066	79109-8466	
36	79109-1017	79109-8417	79109-1067	79109-8467	
38	79109-1018	79109-8418	79109-1068	79109-8468	
40	79109-1019	79109-8419	79109-1069	79109-8469	
42	79109-1020	79109-8420	79109-1070	79109-8470	
44	79109-1021	79109-8421	79109-1071	79109-8471	
46	79109-1022	79109-8422	79109-1072	79109-8472	
48	79109-1023	79109-8423	79109-1073	79109-8473	
50	79109-1024	79109-8424	79109-1074	79109-8474	

* Contact Molex

2.00mm (.079") Pitch Milli-Grid™ Receptacle

87264

Side Entry

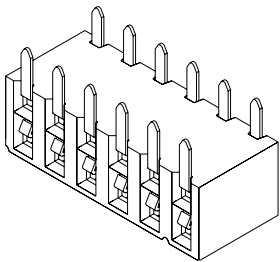

Features and Benefits

- Sizes 8 to 50 circuits
- Surface Mount Compatible

Reference Information

Product Specification: PS-87264
 Packaging: Tube (contact Molex for embossed tape)
 UL File No.: E29179
 CSA File No.: LR19980-182
 Mates With: 0.50mm square pin headers
 Designed In: Millimeters

Electrical

Voltage: 125V
 Current: 1.0A
 Contact Resistance: 15 milliohms max.
 Dielectric Withstanding Voltage: 500V
 Insulation Resistance: 1000 Megohms min.

Mechanical

Contact Insertion Force: 180g max.
 Normal Force: 50g min.

Physical

Housing: Black high-temperature nylon, UL 94V-0
 Contact: Phosphor Bronze
 Plating: See Table
 PCB Thickness: 1.60 ± 0.10mm

Circuits	Order No.		Lead-free
	15μ" Select Gold	30μ" Select Gold	
8	87264-0852	87264-0853	Yes
10	87264-1052	87264-1053	
12	87264-1252	87264-1253	
14	87264-1452	87264-1453	
16	87264-1652	87264-1653	
18	87264-1852	87264-1853	
20	87264-2052	87264-2053	
22	87264-2252	87264-2253	

Circuits	Order No.		Lead-free
	15μ" Select Gold	30μ" Select Gold	
24	87264-2452	87264-2453	Yes
26	87264-2652	87264-2653	
28	87264-2852	87264-2853	
30	87264-3052	87264-3053	
32	87264-3252	87264-3253	
34	87264-3452	87264-3453	
36	87264-3652	87264-3653	
38	87264-3852	87264-3853	

Circuits	Order No.		Lead-free
	15μ" Select Gold	30μ" Select Gold	
40	87264-4052	87264-4053	Yes
42	87264-4252	87264-4253	
44	87264-4452	87264-4453	
46	87264-4652	87264-4653	
48	87264-4852	87264-4853	
50	87264-5052	87264-5053	

2.00mm (.079") Pitch Milli-Grid™ Receptacle

87368
Side Entry
SMT

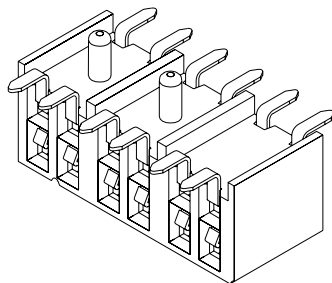

Features and Benefits

- Sizes 10 to 50 circuits
- MCC compatible
- Polarization peg version standard
- Optional without peg version

Reference Information

Product Specification: PS-87264
Packaging: Tube (contact Molex for embossed tape)
Mates With: 0.50mm square pin headers
Designed In: Millimeters

Electrical

Voltage: 125V
Current: 1.0A
Contact Resistance: 15 milliohms max.
Dielectric Withstanding Voltage: 500V
Insulation Resistance: 1000 Megohms min.

Mechanical

Contact Insertion Force: 180g max.
Normal Force: 50g min.

Physical

Housing: Black nylon, UL 94V-0
Contact: Phosphor Bronze
Plating: See Table
PCB Thickness: 1.60 ± 0.10mm

Circuits	Order No.		Lead-free
	15µ" Select Gold	30µ" Select Gold	
10	87368-1024	87368-1025	Yes
12	87368-1224	87368-1225	
14	87368-1424	87368-1425	
16	87368-1624	87368-1625	
18	87368-1824	87368-1825	
20	87368-2024	87368-2025	
22	87368-2224	87368-2225	
24	87368-2424	87368-2425	
26	87368-2624	87368-2625	
28	87368-2824	87368-2825	
30	87368-3024	87368-3025	

Circuits	Order No.		Lead-free
	15µ" Select Gold	30µ" Select Gold	
32	87368-3224	87368-3225	Yes
34	87368-3424	87368-3425	
36	87368-3624	87368-3625	
38	87368-3824	87368-3825	
40	87368-4024	87368-4025	
42	87368-4224	87368-4225	
44	87368-4424	87368-4425	
46	87368-4624	87368-4625	
48	87368-4824	87368-4825	
50	87368-5024	87368-5025	

2.00mm (.079") Pitch Milli-Grid™ Receptacle

87263
Bottom Entry
SMT

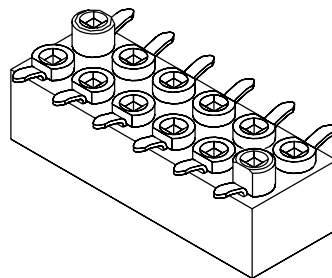

Features and Benefits

- Sizes 4 to 42 circuits
- Locating peg version standard
- Optional without peg version

Reference Information

Product Specification: PS-87263
Packaging: Tube (contact Molex for embossed tape and cap)
UL File No.: E29179
CSA File No.: LR19980
Mates With: 0.50mm square pin headers
Designed In: Millimeters

Electrical

Voltage: 125V
Current: 1.0A
Contact Resistance: 15 milliohms max.
Dielectric Withstanding Voltage: 1000V
Insulation Resistance: 1000 Megohms min.

Mechanical

Contact Insertion Force: 180g max.
Normal Force: 50g min.

Physical

Housing: Black high-temperature nylon, UL 94V-0
Contact: Phosphor Bronze
Plating: See Table

Circuits	Order No.		Lead-free
	15µ" Select Gold	30µ" Select Gold	
4	87263-0423	87263-0425	Yes
6	87263-0623	87263-0625	
8	87263-0823	87263-0825	
10	87263-1023	87263-1025	
12	87263-1223	87263-1225	
14	87263-1423	87263-1425	
16	87263-1623	87263-1625	
18	87263-1823	87263-1825	
20	87263-2023	87263-2025	
22	87263-2223	87263-2225	

Circuits	Order No.		Lead-free
	15µ" Select Gold	30µ" Select Gold	
24	87263-2423	87263-2425	Yes
26	87263-2623	87263-2625	
28	87263-2823	87263-2825	
30	87263-3023	87263-3025	
32	87263-3223	87263-3225	
34	87263-3423	87263-3425	
36	87263-3623	87263-3625	
38	87263-3823	87263-3825	
40	87263-4023	87263-4025	
42	87263-4223	87263-4225	

2.00mm (.079") Pitch Milli-Grid™ Receptacle

87381 Dual Row, SMT Top Entry

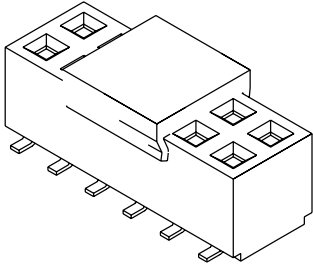

Features and Benefits

- Size 6 to 24, 28 to 50 circuits
- Other plating and void pin options available
- Cap version for robotic delivery
- Contact Molex for peg version

Reference Information

Product Specification: PS-87380
 Packaging: Tube (Contact Molex for tape and reel packaging)
 UL File No.: E29179
 CSA File No.: LR19980A
 Mates With: 0.50mm (.020") square pin headers
 Designed In: Millimeters

Electrical

Current: 1.9A max.
 Contact Resistance: 15 milliohms max.
 Dielectric Withstanding Voltage: 1000V AC/1min.
 Insulation Resistance: 1000 Megohms min.

Mechanical

Contact Insertion Force: 180g max.
 Contact Retention to Housing: 5.38N (1.21 lb) min.
 Durability: 25 cycles

Physical

Housing: Black high-temp thermoplastic
 Contact: Copper Alloy
 Plating: See Table

Circuits	Order No.		Lead-free
	0.38mm (15μ") Gold	0.76mm (30μ") Gold	
6	87381-0664	87381-0663	Yes
8	87381-0864	87381-0863	
10	87381-1064	87381-1063	
12	87381-1264	87381-1263	
14	87381-1464	87381-1463	
16	87381-1664	87381-1663	
18	87381-1864	87381-1863	
20	87381-2064	87381-2063	
22	87381-2264	87381-2263	
24	87381-2464	87381-2463	
28	87381-2864	87381-2863	

Circuits	Order No.		Lead-free
	0.38mm (15μ") Gold	0.76mm (30μ") Gold	
30	87381-3064	87381-3063	Yes
32	87381-3264	87381-3263	
34	87381-3464	87381-3463	
36	87381-3664	87381-3663	
38	87381-3864	87381-3863	
40	87381-4064	87381-4063	
42	87381-4264	87381-4263	
44	87381-4464	87381-4463	
46	87381-4664	87381-4663	
48	87381-4864	87381-4863	
50	87381-5064	87381-5063	

2.00mm (.079") Pitch Milli-Grid™ Receptacle

87340 Top Entry SMT (VLPR2)

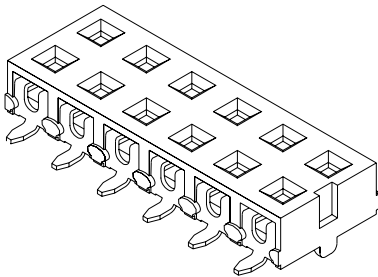

Features and Benefits

- Sizes 4 to 20 circuits
- Locating peg version standard
- Very low profile height 2.15mm
- End-to-end stackable
- Optional without peg version
- Contact Molex for pick-and-place cap or embossed tape

Reference Information

Product Specification: PS-87340
 Packaging: Tube
 UL File No.: E29179
 CSA File No.: LR19980
 Mates With: 0.50mm square pin headers
 Designed In: Millimeters

Electrical

Voltage: 125V
 Current: 1.0A
 Contact Resistance: 15 milliohms max.
 Dielectric Withstanding Voltage: 1000V
 Insulation Resistance: 1000 Megohms min.

Mechanical

Contact Insertion Force: 180g max.
 Contact Retention to Housing: 0.32kg min.
 Normal Force: 50g min.

Physical

Housing: Black LCP, UL 94V-0
 Contact: Phosphor Bronze
 Plating: See Table

Circuits	Order No.		Lead-free
	15μ" Select Gold	30μ" Select Gold	
4	87340-0424	87340-0423	Yes
6	87340-0624	87340-0623	
8	87340-0824	87340-0823	
10	87340-1024	87340-1023	
12	87340-1224	87340-1223	
14	87340-1424	87340-1423	
16	87340-1624	87340-1623	
18	87340-1824	87340-1823	
20	87340-2024	87340-2023	

2.00mm (.079") Pitch Milli-Grid™ Cable-to-Board Receptacle

87568
Dual Row, IDT

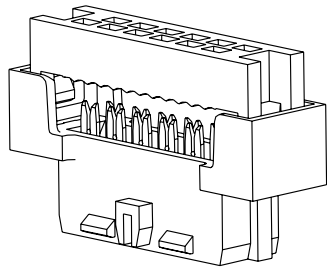

Features and Benefits

- Pre-loaded upper housing offers precise cover-to-base alignment, ensuring a reliable termination
- Early-entry single-beam contact provides long wiping action during mating
- Optional polarization and locking ramp
- Optional strain relief is available

Reference Information

Product Specification: PS-87568-004
 Packaging: Tray
 Wire Style: UL2651, UL2678
 UL File No.: E29179
 CSA File No.: LR19980
 Mates With: Milli-Grid 2.00mm (.079") Headers
 Use With: 87569 Strain Relief
 Designed In: Millimeters

Electrical

Voltage: 125V DC
 Current: 1.0A
 Contact Resistance: 30 milliohms max.
 Dielectric Withstanding Voltage: 500V AC
 Insulation Resistance: 5000 Megohms min.

Mechanical

Contact Retention to Housing: 1.96N (0.44 lb) max.
 Wire Pull-Out Force: 2.45N (0.55 lb) max.
 Mating Force: 1.96N (0.44 lb) max.
 Unmating Force: 0.39N (0.09 lb) min.
 Durability: 600 cycles max.

Physical

Housing: Black glass-filled PBT
 Contact: Copper Alloy
 Plating: Contact Area—See Table Below
 Underplating—Nickel
 Cable: 1.00mm Flat Cable, 7 Strands, 28 AWG

Circuits	Order No.		X=4 With Center Polarization	X=6 Without Polarization and Locking Ramp	X=7 With Single Locking Ramp	X=9 With Polarization and Locking Ramp	Lead-free
	0.38 μ m (15 μ "") Gold	0.76 μ m (30 μ "") Gold					
10	87568-10X3	87568-10X4	No		Yes	No	
12	87568-12X3	87568-12X4					
14	87568-14X3	87568-14X4					
16	87568-16X3	87568-16X4					
20	87568-20X3	87568-20X4					
22	87568-22X3	87568-22X4	Yes	Yes	No	Yes	
24	87568-24X3	87568-24X4					
26	87568-26X3	87568-26X4					
30	87568-30X3	87568-30X4					
34	87568-34X3	87568-34X4					
40	87568-40X3	87568-40X4					
44	87568-44X3	87568-44X4					
50	87568-50X3	87568-50X4					

2.00mm (.079") Pitch Milli-Grid™ Cable-to-Board Strain Relief

87569
IDT

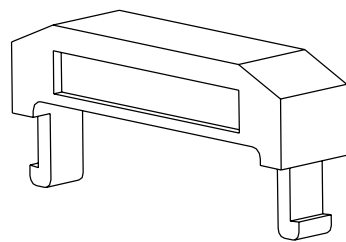

Features and Benefits

- Sizes 10 to 50 circuits
- Provide additional cable retention

Reference Information

Product Specification: PS-87568-004
 Packaging: Bag
 Use With: 87568
 Designed In: Millimeters

Physical

Housing: Black thermoplastic, UL 94V-0

Circuits	Order No.
10	87569-1010
12	87569-1012
14	87569-1014
16	87569-1016
20	87569-1020
22	87569-1022
24	87569-1024

Circuits	Order No.
26	87569-1026
30	87569-1030
34	87569-1034
40	87569-1040
44	87569-1044
50	87569-1050

2.00mm (.079") Pitch Milli-Grid™ Header

87831 Shrouded Vertical, SMC

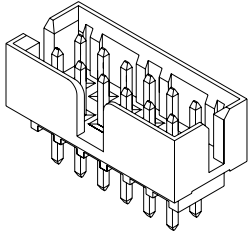

Features and Benefits

- Sizes 4 to 50 circuits
- Fully shrouded to protect pins during mating/unmating
- Center slot for polarization
- Front latches for mechanical locking
- Center polarization slot (6 to 12 circuits); center polarization slot and front latches (14 to 50 circuits)

Reference Information

Product Specification: PS-87831-027
 Packaging: Tube (contact Molex for embossed tape)
 UL File No.: E29179
 CSA File No.: LR19980
 Mates With: 50394, 51110 and 87568
 Designed In: Millimeters

Electrical

Voltage: 125V
 Current: 2.0A
 Dielectric Withstanding Voltage: 1000V
 Insulation Resistance: 1000 Megohms min.

Physical

Housing: Black 4/6 nylon, UL 94V-0
 Contact: Phosphor Bronze
 Plating: See Table

Circuits	Order No.		Lead-free
	15µm Select Gold	30µm Select Gold	
4	87831-0420	87831-0421	Yes
6	87831-0620	87831-0621	
8	87831-0820	87831-0821	
10	87831-1020	87831-1021	
12	87831-1220	87831-1221	
14	87831-1420	87831-1421	
16	87831-1620	87831-1621	
18	87831-1820	87831-0621	
20	87831-2020	87831-2021	
22	87831-2220	87831-2221	
24	87831-2420	87831-2421	
26	87831-2620	87831-2621	

Circuits	Order No.		Lead-free
	15µm Select Gold	30µm Select Gold	
28	87831-2820	87831-2821	Yes
30	87831-3020	87831-3021	
32	87831-3220	87831-3221	
34	87831-3420	87831-3421	
36	87831-3620	87831-3621	
38	87831-3820	87831-3821	
40	87831-4020	87831-4021	
42	87831-4220	87831-4221	
44	87831-4420	87831-4421	
46	87831-4620	87831-4621	
48	87831-4820	87831-4821	
50	87831-5020	87831-5021	

2.00mm (.079") Pitch Milli-Grid™ Header

87832 Shrouded SMT

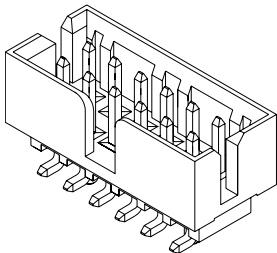

Features and Benefits

- Sizes 4 to 50 circuits
- Fully shrouded to protect pins during mating/unmating
- Center slot for polarization
- Front latches for mechanical locking
- Locating pegs for automatic insertion process
- Center polarization slot (6 to 12 circuits); center polarization and front latches (14 to 50 circuits)
- Contact Molex for embossed tape

Reference Information

Product Specification: PS-87831-027
 Packaging: Tube (contact Molex for tape and reel)
 UL File No.: E29179
 CSA File No.: LR19980
 Mates With: 50394, 51110 and 87568
 Designed In: Millimeters

Electrical

Current: 2.0A
 Dielectric Withstanding Voltage: 1000V
 Insulation Resistance: 1000 Megohms min.

Physical

Housing: Black 4/6 nylon, UL 94V-0
 Contact: Phosphor Bronze
 Plating: See Table

Circuits	Order No.		Lead-free
	15µm Select Gold	30µm Select Gold	
4	87832-0420	87832-0421	Yes
6	87832-0620	87832-0621	
8	87832-0820	87832-0821	
10	87832-1020	87832-1021	
12	87832-1220	87832-1221	
14	87832-1420	87832-1421	
16	87832-1620	87832-1621	
18	87832-1820	87832-1821	
20	87832-2020	87832-2021	
22	87832-2220	87832-2221	
24	87832-2420	87832-2421	
26	87832-2620	87832-2621	

Circuits	Order No.		Lead-free
	15µm Select Gold	30µm Select Gold	
28	87832-2820	87832-2821	Yes
30	87832-3020	87832-3021	
32	87832-3220	87832-3221	
34	87832-3420	87832-3421	
36	87832-3620	87832-3621	
38	87832-3820	87832-3821	
40	87832-4020	87832-4021	
42	87832-4220	87832-4221	
44	87832-4420	87832-4421	
46	87832-4620	87832-4621	
48	87832-4820	87832-4821	
50	87832-5020	87832-5021	

2.00mm (.079") Pitch Milli-Grid™ Header

87833
Shrouded
Right Angle

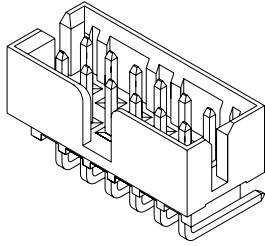

Features and Benefits

- Sizes 4 to 50 circuits
- Fully shrouded to protect pins during mating/unmating
- Center slot for polarization
- Front latches for mechanical locking
- Center polarization slot (6 to 12 circuits); center polarization slot and front latches (14 to 50 circuits)
- Surface Mount Compatible
- Contact Molex for embossed tape

Reference Information

Product Specification: PS-87831-027
 Packaging: Tube (contact Molex for tape and reel)
 UL File No.: E29179
 CSA File No.: LR19980
 Mates With: 50394, 51110 and 87568
 Designed In: Millimeters

Electrical

Current: 2.0A
 Dielectric Withstanding Voltage: 1000V
 Insulation Resistance: 1000 Megohms min.

Physical

Housing: Black 4/6 nylon, UL 94V-0
 Contact: Phosphor Bronze
 Plating: See Table

Circuits	Order No.		Lead-free	Circuits	Order No.		Lead-free
	15µm Select Gold	30µm Select Gold			15µm Select Gold	30µm Select Gold	
4	87833-0420	87833-0421	Yes	28	87833-2820	87833-2821	Yes
6	87833-0620	87833-0621		30	87833-3020	87833-3021	
8	87833-0820	87833-0821		32	87833-3220	87833-3221	
10	87833-1020	87833-1021		34	87833-3420	87833-3421	
12	87833-1220	87833-1221		36	87833-3620	87833-3621	
14	87833-1420	87833-1421		38	87833-3820	87833-3821	
16	87833-1620	87833-1621		40	87833-4020	87833-4021	
18	87833-1820	87833-1821		42	87833-4220	87833-4221	
20	87833-2020	87833-2021		44	87833-4420	87833-4421	
22	87833-2220	87833-2221		46	87833-4620	87833-4621	
24	87833-2420	87833-2421		48	87833-4820	87833-4821	
26	87833-2620	87833-2621		50	87833-5020	87833-5021	

2.00mm (.079") Pitch Milli-Grid™ Header

87981 / 87982 / 87983 / 87984
With Latch Hook

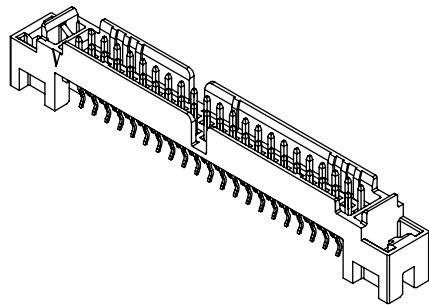

Features and Benefits

- Early entry system provides long pin wipe
- Polarization slot to prevent reversed mating
- Polarization peg in vertical type (series 87982/87983) ensures proper orientation during mounting to PCB

Reference Information

Product Specification: PS-87981-018
 Packaging: See table
 Mates With: 87985 IDT Receptacle

Electrical

Voltage: 125V AC
 Current: 2.0A max.
 Contact Resistance: 30 milliohms max.
 Dielectric Strength: 500V AC
 Insulation Resistance: 1000 Megohms min.

Mechanical

Contact Retention to Housing: 0.85kgf
 Mating Force: 200gf per circuit max.
 Unmating Force: 40gf per circuit min.
 Durability: 30 cycles

Physical

Housing: See table
 Contact: Phosphor Bronze
 Plating: Contact Area—0.38µm (15µ") min. Gold
 Solder Tail Area—Tin
 Underplating: Nickel
 PCB Thickness: 1.60mm +/-0.10mm

Circuits	Order No.	Orientation	PCB Mounting	Packaging	Housing	Lead-free
30	87982-3030	Vertical	Through Hole	Tube	Black glass-filled nylon, UL 94V-0	Yes
40	87982-3040	Vertical	Through Hole	Tube	Black glass-filled nylon, UL 94V-0	
40	87984-3040	Right Angle	Through Hole	Tube	Black glass-filled nylon, UL 94V-0	
44	87981-3044	Right Angle	Straddle Mount	Tube	Black glass-filled LCP, UL 94V-0	
44	87982-3044	Vertical	Through Hole	Tube	Black glass-filled nylon, UL 94V-0	
44	87983-3044	Vertical	SMT	Tape and Reel	Black glass-filled nylon, UL 94V-0	
50	87981-3050	Right Angle	Straddle Mount	Tube	Black glass-filled LCP, UL 94V-0	
50	87982-3050	Vertical	Through Hole	Tube	Black glass-filled nylon, UL 94V-0	

Contact Molex for availability of other circuit sizes (4-50 circuits)

2.00mm (.079") Pitch Milli-Grid™ IDT Cable-to-Board Receptacle

87985

**Dual Row, IDT
With Metal Latch**

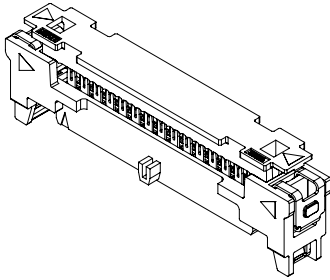

Circuits	Order No.	Lead-free
30	87985-3030	Yes
40	87985-3040	
44	87985-3044	
50	87985-3050	

Contact Molex for availability of other circuit sizes (4-50 circuits)

Features and Benefits

- Metal latches provide strong retention and full mate to header
- Strain relief provides greater retention to header

Reference Information

Product Specification: PS-87985-026

Packaging: Tray

Mates With: 87981, 87982, 87983 and 87984 headers

Electrical

Voltage: 125V AC (RMS)/DC max.

Current: 1.0A max.

Contact Resistance: 30 milliohms max.

Dielectric Withstanding Voltage: 500V AC

Insulation Resistance: 1000 Megohms min.

Mechanical

Contact Retention to Housing: 0.20kgf min.

Mating Force: 200gf max. per circuit

Unmating Force: 40gf min. per circuit

Durability: 30 cycles

Physical

Housing: Gray glass-filled PBT, UL 94V-0

Contact: Copper Alloy

Plating: Contact Area—0.38µm (15µ") Gold

Solder Tail Area—Tin

Underplating: Nickel

Wire Gauge: 26 and 28 AWG stranded flat ribbon cable

Mi II™ (2.00 x 2.50mm) Connection System

Features

- 2.00mm pitch low profile wire-to-board connector
- Single and dual row, crimp and IDT
- Low insertion force design, locking features and high reliability
- Kinked header pins
- Clip allows back-to-back stacking of single row IDT assemblies
- Application tooling for use in assembling harnesses
- Board-in type is available in vertical and right angle types

2.00 to 2.50mm (.079 to .098") Pitch PCB and Wire Connectors

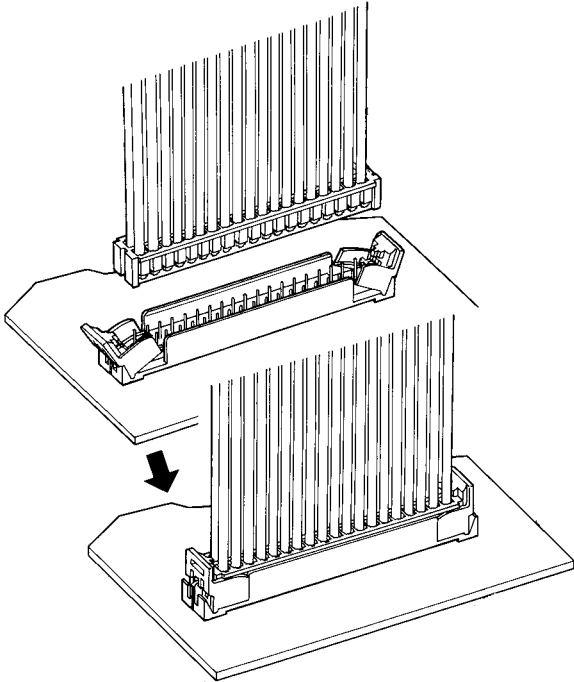

Eject Lever Type

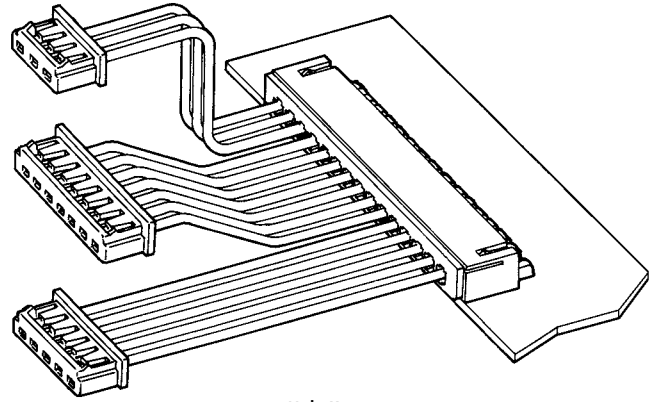

Multi Harnesses

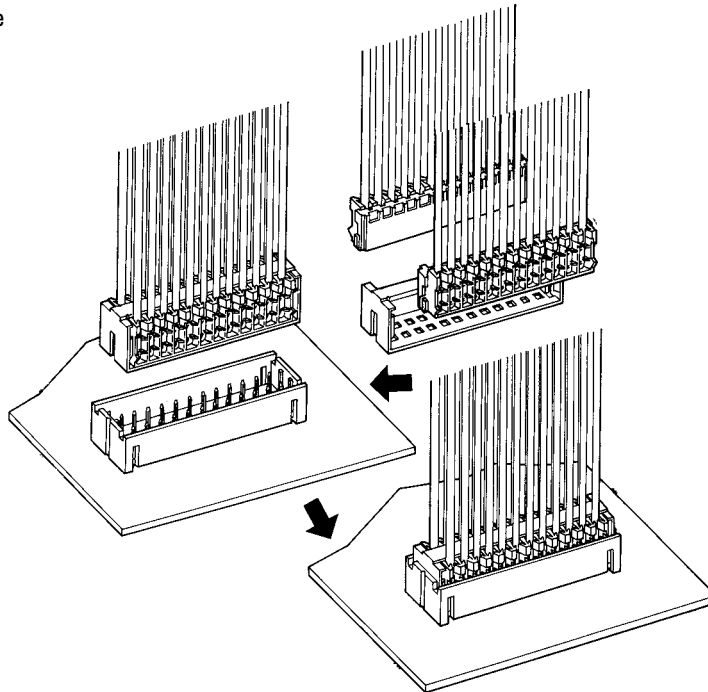

With Clip Connection Type

Mi II™ System Chart

Dual Row

50212
Terminal

Single Row

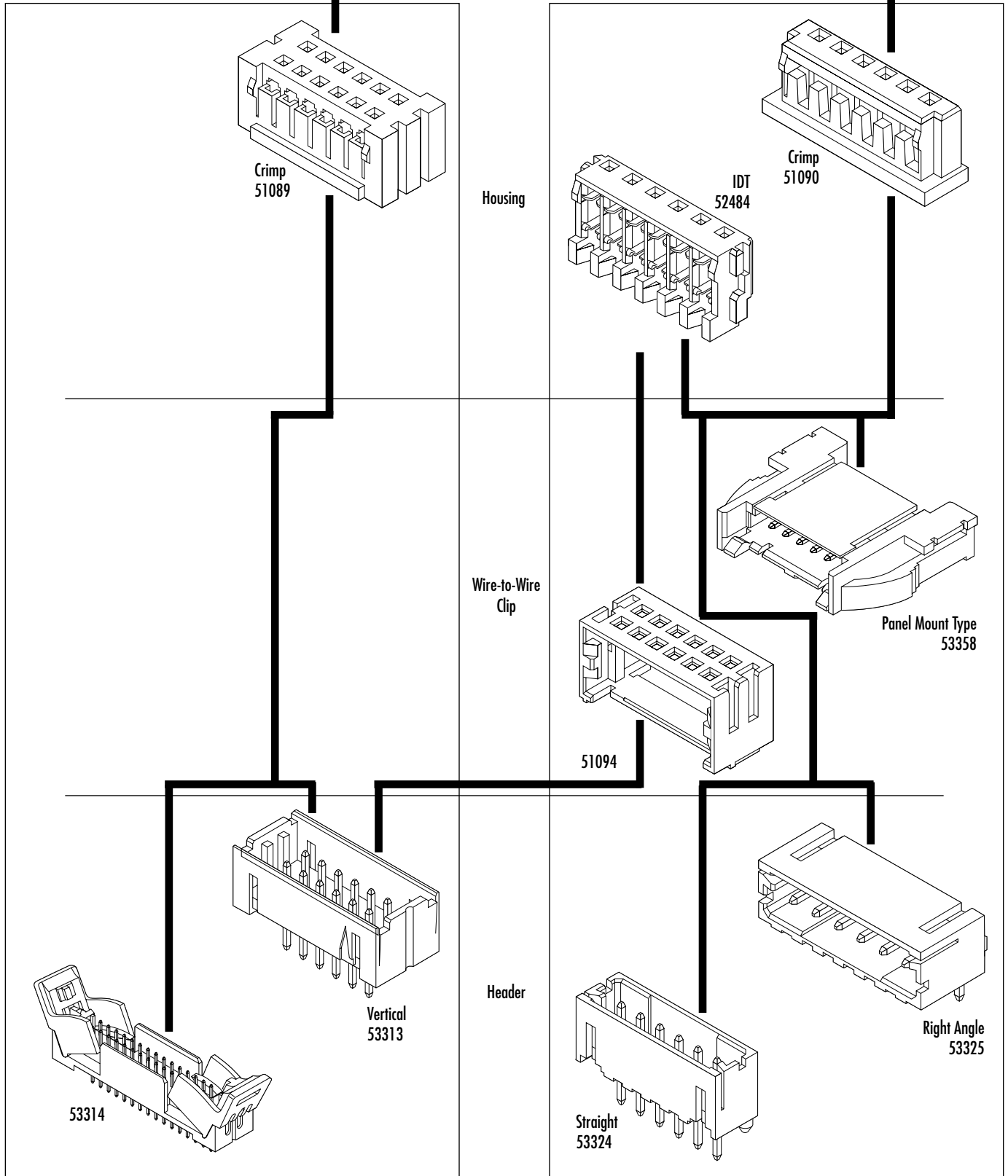
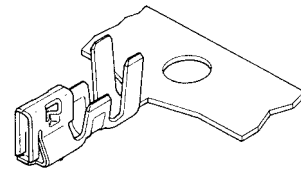

2.00 to 2.50mm (.079 to .098") Pitch PCB and Wire Connectors

2.00mm (.079") Pitch Mi II™ System Wire-to-Board Housing

51090
Single Row
Crimp

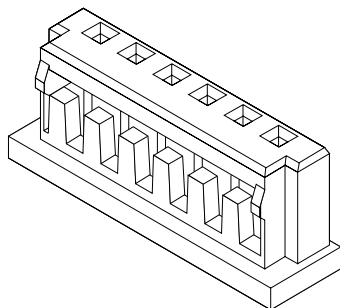

Circuits	Order No.
2	51090-0200
3	51090-0300
4	51090-0400
5	51090-0500
6	51090-0600
7	51090-0700
8	51090-0800

Circuits	Order No.
9	51090-0900
10	51090-1000
11	51090-1100
12	51090-1200
13	51090-1300
14	51090-1400
15	51090-1500

Features and Benefits

- Sizes 2 to 15 circuits

Reference Information

Product Specification: Refer to Mates With items
Packaging: Bag
UL File No.: E29179
Mates With: 53324, 53325 and 53358
Use With: 50212
Designed In: Millimeters

Electrical

Voltage: 125V max.
Current:

AWG	22	24	26	28	30
	2.5A	2.0A	1.5A	1.0A	0.5A

Contact Resistance: 20 milliohms max.
Dielectric Withstanding Voltage: 500V AC/1 min.
Insulation Resistance: 1000 Megohms min.

Physical

Housing: PBT, UL 94V-0

2.00mm (.079") Pitch Mi II™ System Wire-to-Board Receptacle

52484
Single Row
IDT

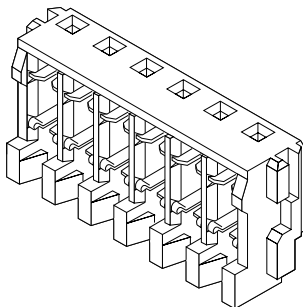

Circuits	Order No.	Lead-free
2	52484-0210	Yes
3	52484-0310	
4	52484-0410	
5	52484-0510	
6	52484-0610	
7	52484-0710	
8	52484-0810	

Circuits	Order No.	Lead-free
9	52484-0910	Yes
10	52484-1010	
11	52484-1110	
12	52484-1210	
13	52484-1310	
14	52484-1410	
15	52484-1510	

Features and Benefits

- Sizes 2 to 15 circuits
- IDT provides secure and cost-effective termination

Reference Information

Product Specification: Refer to Mates With items
Packaging: Bag
UL File No.: E29179
CSA File No.: LR19980
Mates With: 53324, 53325, 53358 and 53313 (with 51094 clip)
Designed In: Millimeters

Electrical

Voltage: 125V max.
Current:

AWG	26	28
	1.5A	1.0A

Contact Resistance: 20 milliohms max.
Dielectric Withstanding Voltage: 500V AC/1 min.
Insulation Resistance: 1000 Megohms min.

Physical

Housing: Glass-filled Nylon, UL 94V-0
Contact: Phosphor Bronze
Plating: Tin
Wire Range: 26 to 28 AWG
Insulation Range: 0.85 to 1.05mm dia.

2.00mm (.079") Pitch Mi II™ System Clip

51094
Dual Row

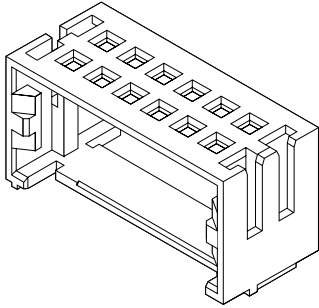

Features and Benefits

- Sizes 6 to 30 circuits
- Joins two single row receptacles (52484) to mate with a dual row header (53313)

Reference Information

Product Specification: PS-52478-002
Packaging: Bag
CSA File No.: LR19980
Mates With: 53313
Use With: 52484
Designed In: Millimeters

Physical

Housing: Gray PBT, UL 94V-0

Circuits	Order No.
6	51094-0605
8	51094-0805
10	51094-1005
12	51094-1205
14	51094-1405
16	51094-1605
18	51094-1805

Circuits	Order No.
20	51094-2005
22	51094-2205
24	51094-2405
26	51094-2605
28	51094-2805
30	51094-3005

2.00mm (.079") Pitch Mi II™ System Wire-to-Board Header

53324
Single Row
Vertical

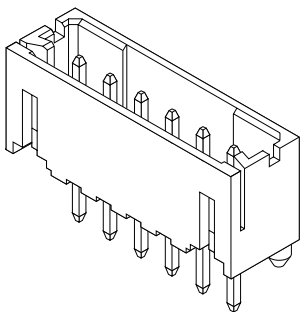

Features and Benefits

- Sizes 2 to 15 circuits
- Outer pins are kinked
- Polarization peg ensures proper PCB placement

Reference Information

Product Specification: PS-51090-016, PS-52484-021
Packaging: Tray
UL File No.: E29179
CSA File No.: LR19980
Mates With: 51090 and 52484
Designed In: Millimeters

Electrical

Voltage: 125V max.

Current:

AWG	22	24	26	28	30
	2.5A	2.0A	1.5A	1.0A	0.5A

Contact Resistance: 20 milliohms max.

Dielectric Withstanding Voltage: 500V AC/1 min.

Insulation Resistance: 1000 Megohms min.

Physical

Housing: Glass-filled Nylon, UL 94V-0

Contact: Brass

Plating: Tin

Circuits	Order No.	Lead-free
2	53324-0260	Yes
3	53324-0360	
4	53324-0460	
5	53324-0560	
6	53324-0660	
7	53324-0760	
8	53324-0860	

Circuits	Order No.	Lead-free
9	53324-0960	Yes
10	53324-1060	
11	53324-1160	
12	53324-1260	
13	53324-1360	
14	53324-1460	
15	53324-1560	

2.00mm (.079") Pitch Mi II™ System Wire-to-Board Header

53325
Single Row
Right Angle

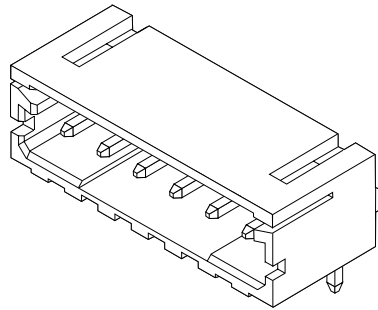

Features and Benefits

- Sizes 2 to 15 circuits
- Outer pins are kinked

Reference Information

Product Specification: PS-51090-016, PS-52484-021

Packaging: Tray

UL File No.: E29179

CSA File No.: LR19980

Mates With: 51090 and 52484

Designed In: Millimeters

Electrical

Voltage: 125V max.

Current:

AWG	22	24	26	28	30
	2.5A	2.0A	1.5A	1.0A	0.5A

Contact Resistance: 20 milliohms max.

Dielectric Withstanding Voltage: 500V AC/1 min.

Insulation Resistance: 1000 Megohms min.

Physical

Housing: Glass-filled PBT, UL 94V-0

Contact: Brass

Plating: Tin

Circuits	Order No.	Lead-free
2	53325-0260	Yes
3	53325-0360	
4	53325-0460	
5	53325-0560	
6	53325-0660	
7	53325-0760	
8	53325-0860	

Circuits	Order No.	Lead-free
9	53325-0960	Yes
10	53325-1060	
11	53325-1160	
12	53325-1260	
13	53325-1360	
14	53325-1460	
15	53325-1560	

2.00mm (.079") Pitch Mi II™ System Wire-to-Board Housing

51089
Dual Row
Crimp

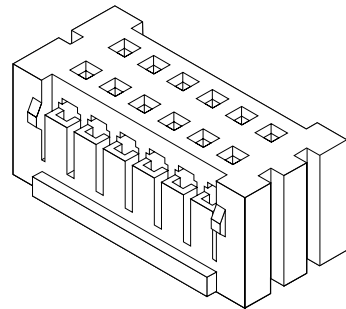

Features and Benefits

- Sizes 10 to 60 circuits
- Housing lance provides extra terminal retention
- Friction lock on circuits 10 to 28 provides additional mating retention

Reference Information

Product Specification: PS-51089-005

Packaging: Bag

CSA File No.: LR 19980

Mates With: 53313 and 53314

Use With: 50212

Designed In: Millimeters

Electrical

Voltage: 125V max.

Current:

AWG	22	24	26	28	30
	2.5A	2.0A	1.5A	1.0A	0.5A

Contact Resistance: 20 milliohms max.

Dielectric Withstanding Voltage: 500V AC/1 min.

Insulation Resistance: 1000 Megohms min.

Physical

Housing: Gray glass-filled Polyester, UL 94V-0

Circuits	Order No.	Friction Lock
10	51089-1005	Yes
12	51089-1205	
14	51089-1405	
16	51089-1605	
18	51089-1805	
20	51089-2005	
22	51089-2205	
24	51089-2405	

Circuits	Order No.	Friction Lock
26	51089-2605	Yes
28	51089-2805	
30	51089-3005	No
34	51089-3405	
40	51089-4005	
50	51089-5005	
60	51089-6005	

2.00mm (.079") Pitch Mi II™ System Wire-to-Board Header

53313
Dual Row
Vertical

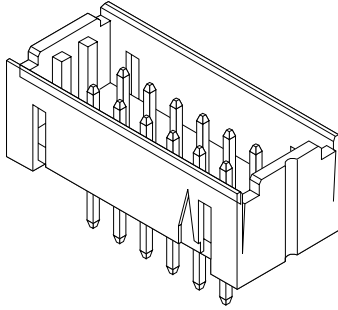

Features and Benefits

- Sizes 6 to 60 circuits
- Polarization peg provides correct PCB placement

Reference Information

Product Specification: PS-51089-005, PS-52478-002
Packaging: Tray
UL File No.: E29179
CSA File No.: LR19980
Mates With: 51089 and 52484 (with 51094 clip)
Accepts: 51094 clip with two 52484 IDT receptacles
Designed In: Millimeters

Electrical

Voltage: 125V max.

Current:

AWG	22	24	26	28	30
	2.5A	2.0A	1.5A	1.0A	0.5A

Contact Resistance: 20 milliohms max.

Dielectric Withstanding Voltage: 500V AC/1 min.

Insulation Resistance: 1000 Megohms min.

Physical

Housing: Gray glass-filled Nylon, UL 94V-0

Contact: Brass

Plating: Tin

Circuits	Order No.	Lead-free
6	53313-0665	Yes
8	53313-0865	
10	53313-1065	
12	53313-1265	
14	53313-1465	
16	53313-1665	
18	53313-1865	
20	53313-2065	
22	53313-2265	

Circuits	Order No.	Lead-free
24	53313-2465	Yes
26	53313-2665	
28	53313-2865	
30	53313-3065	
34	53313-3465	
40	53313-4065	
50	53313-5065	
60	53313-6065	

2.00mm (.079") Pitch Mi II™ System Wire-to-Board Header

53314
Dual Row, Vertical
With Eject Levers

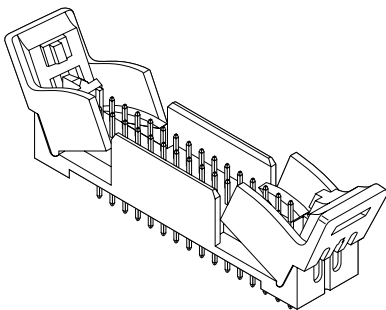

Features and Benefits

- Sizes 30 to 60 circuits
- Polarization peg provides correct PCB placement

Reference Information

Product Specification: PS-51089-005
Packaging: Tray
UL File No.: E29179
CSA File No.: LR19980
Mates With: 51089
Designed In: Millimeters

Electrical

Voltage: 125V max.

Current:

AWG	22	24	26	28	30
	2.5A	2.0A	1.5A	1.0A	0.5A

Contact Resistance: 20 milliohms max.

Dielectric Withstanding Voltage: 500V AC/1 min.

Insulation Resistance: 1000 Megohms min.

Physical

Housing: Gray glass-filled Nylon, UL 94V-0

Contact: Brass

Plating: Tin

Circuits	Order No.	Lead-free
30	53314-3065	Yes
34	53314-3465	
40	53314-4065	
50	53314-5065	
60	53314-6065	

2.00mm (.079") Pitch Mi II™ System Wire-to-Wire Panel Adapter

53358
Single Row

Features and Benefits

- Low insertion force
- Locking feature
- Low profile

Reference Information

Product Specification: PS-53358-001
Packaging: Bag
Mates With: 51090 and 52484
Designed In: Millimeters

Electrical

Voltage: 125V max.

Current:

AWG	24	26	28	30
	2.0A	1.5A	1.0A	0.5A

Contact Resistance: 40 milliohms max.

Dielectric Withstanding Voltage: 500V AC/1 min.

Insulation Resistance: 1000 Megohms min.

Physical

Housing: White PBT, UL 94V-0

Contact: Brass

Plating: Tin

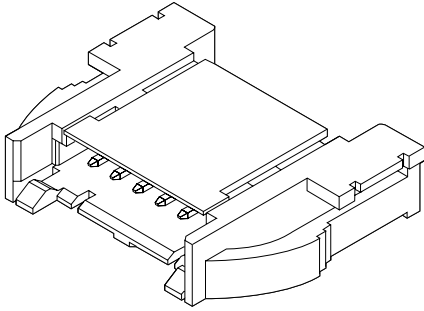

Circuits	Order No.	Lead-free
2	53358-0240	Yes
3	53358-0340	
4	53358-0440	
5	53358-0540	
6	53358-0640	
7	53358-0740	
8	53358-0840	

Circuits	Order No.	Lead-free
9	53358-0940	Yes
10	53358-1040	
11	53358-1140	
12	53358-1240	
13	53358-1340	
14	53358-1440	
15	53358-1540	

2.00 to 2.50mm (.079 to .098") Pitch PCB and Wire Connectors

**2.00mm (.079") Pitch
iGrid™
Wire-to-Board
Crimp Terminal
501647/501648
Female**

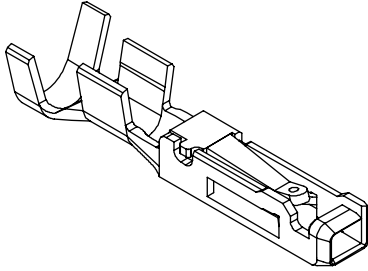

Features and Benefits

- Polarization between housing and terminal ensures terminal always seats properly in housing

Reference Information

Product Specification: PS-501646-001
Packaging: Reel and Bag
Use With: 501646 housing
Designed In: Millimeters

Electrical

Voltage: 250V max.
Current: 2.0A max.

Physical

Contact: Copper Alloy
Plating: Tin
Insulation Diameter: 501647—1.50 mm dia. max.
501648—1.40 mm dia. max.
Strip Length: 2.10 to 2.50 mm

AWG	Order No.	Packing	Lead-free
22-26	501647-1000	Reel	Yes
22-26	501647-1100	Bag	
26-28	501648-1000	Reel	

**2.00mm (.079") Pitch
iGrid™
Wire-to-Board
Housing
501646
Dual Row
Positive Lock**

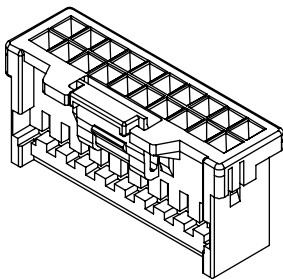

Features and Benefits

- Sizes 10 to 40 circuits
- Polarization between housing and terminal ensures terminal always seats properly in housing
- Internal lock prevents wire tangling, provides space savings and audible click

Reference Information

Product Specification: PS-501646-001
Packaging: Bag
Mates With: 501645, 501876
Use With: 501647/501648 terminal
Designed In: Millimeters

Electrical

Voltage: 250V max.
Current: 2.0A max.
Contact Resistance: 20 milliohms max.
Dielectric Withstanding Voltage: 1000V AC/1 min.
Insulation Resistance: 1000 Megohms min.

Physical

Housing: Nylon, UL 94V-0

Circuits	Order No.	Lead-free	Circuits	Order No.	Lead-free
10	501646-1000	Yes	26	501646-2600	Yes
12	501646-1200		28	501646-2800	
14	501646-1400		30	501646-3000	
16	501646-1600		32	501646-3200	
18	501646-1800		34	501646-3400	
20	501646-2000		36	501646-3600	
22	501646-2200		38	501646-3800	
24	501646-2400		40	501646-4000	



2.00mm (.079") Pitch iGrid™ Wire-to-Board Header

501645 Dual Row, Vertical With PCB Locator

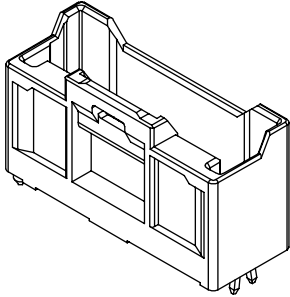

Features and Benefits

- Sizes 10 to 40 circuits
- Compact design saves PCB real estate, high density
- Fully shrouded headers withstand rugged handling and vibration
- Internal lock prevents wire tangling, provides space savings and audible click

Reference Information

Product Specification: PS-501646-001
Packaging: Tray
Mates With: 501646
Designed In: Millimeters

Electrical

Voltage: 250V max.
Current: 2.0A max.
Contact Resistance: 20 milliohms max.
Dielectric Withstanding Voltage: 1000V AC/1 min.
Insulation Resistance: 1000 Megohms min.

Physical

Housing: Glass-filled Nylon, UL 94V-0
Contact: Brass
Plating: Tin over Copper

Circuits	Order No.	Lead-free
10	501645-1020	Yes
12	501645-1220	
14	501645-1420	
16	501645-1620	
18	501645-1820	
20	501645-2020	
22	501645-2220	
24	501645-2420	

Circuits	Order No.	Lead-free
26	501645-2620	Yes
28	501645-2820	
30	501645-3020	
32	501645-3220	
34	501645-3420	
36	501645-3620	
38	501645-3820	
40	501645-4020	

2.00mm (.079") Pitch iGrid™ Wire-to-Board Header

501876 Dual Row Right Angle

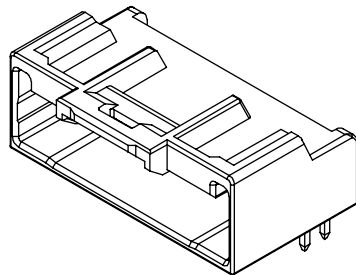

Features and Benefits

- Sizes 10 to 40 circuits
- Compact design saves PCB real estate, high density
- Fully shrouded headers withstand rugged handling and vibration
- Internal lock prevents wire tangling, provides space savings and audible click

Reference Information

Product Specification: PS-501646-001
Packaging: Tray
Mates With: 501646
Designed In: Millimeters

Electrical

Voltage: 250V max.
Current: 2.0A max.
Contact Resistance: 20 milliohms max.
Dielectric Withstanding Voltage: 1000V AC/1 min.
Insulation Resistance: 1000 Megohms min.

Physical

Housing: Glass-filled Nylon, UL 94V-0
Contact: Brass
Plating: Tin over Copper

Circuits	Order No.	Lead-free
10	501876-1040	Yes
12	501876-1240	
14	501876-1440	
16	501876-1640	
18	501876-1840	
20	501876-2040	
22	501876-2240	
24	501876-2440	

Circuits	Order No.	Lead-free
26	501876-2640	Yes
28	501876-2840	
30	501876-3040	
32	501876-3240	
34	501876-3440	
36	501876-3640	
38	501876-3840	
40	501876-4040	

2.00mm (.079") Pitch CLIK-Mate™ Wire-to-Board Crimp Terminal 502438

Reference Information
Product Specification: PS-502443-001
Packaging: Reel and Bag
Use With: 502439 housing
Designed In: Millimeters

Electrical
Voltage: 250V max.
Current: 3.0A max.

Physical
Contact: Copper Alloy
Plating: Tin over Nickel
Insulation Diameter: 1.50 mm dia. max.
Strip Length: 1.90 to 2.30 mm
Wire Gauge: 22 to 26 AWG

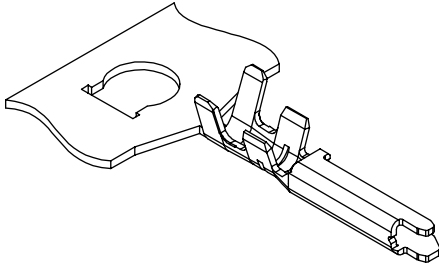

Order No.	Packaging	Lead-free
502438-0000	Reel	Yes
502438-0100	Bag	

2.00mm (.079") Pitch CLIK-Mate™ Wire-to-Board Housing 502439 Single Row Positive Lock

- Features and Benefits**
- Sizes 4 to 14 circuits
 - Audible "click," low insertion force and secure mating
 - Tuning fork style contact design secures contact and avoids terminal stubbing

Reference Information
Product Specification: PS-502443-001
Packaging: Bag
Mates With: 502443, 502494
Use With: 502438 terminal
Designed In: Millimeters

Electrical
Voltage: 250V max.
Current: 3.0A max.
Contact Resistance: 20 milliohms max.
Dielectric Withstanding Voltage: 800V AC/1 min.
Insulation Resistance: 1000 Megohms min.

Physical
Housing: White PBT, UL 94V-0

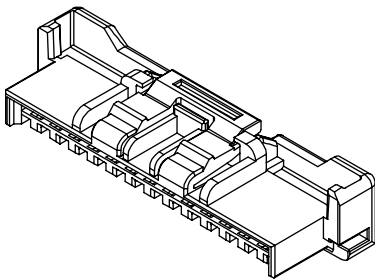

Circuits	Order No.	Lead-free
4	502439-0400	Yes
5	502439-0500	
6	502439-0600	
8	502439-0800	
12	502439-1200	
13	502439-1300	
14	502439-1400	

2.00mm (.079") Pitch CLIK-Mate™ Wire-to-Board PCB Receptacle

502443
Single Row
Vertical

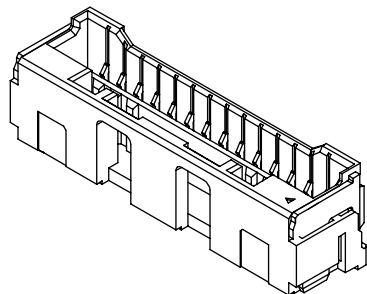

Circuits	Order No.	Lead-free
4	502443-0470	Yes
5	502443-0570	
6	502443-0670	
8	502443-0870	
12	502443-1270	
13	502443-1370	
14	502443-1470	

Features and Benefits

- Sizes 4 to 14 circuits
- Audible "click," low insertion force and secure mating
- Tuning fork style contact design secures contact and avoids terminal stubbing
- Reinforced metal solder tabs enable housing wall support and secure PCB retention
- Flat area for pick-and-place is provided

Reference Information

Product Specification: PS-502443-001
Packaging: Embossed tape
Mates With: 502439
Designed In: Millimeters

Electrical

Voltage: 250V max.
Current: 3.0A max.
Contact Resistance: 20 milliohms max.
Dielectric Withstanding Voltage: 800V AC/1 min.
Insulation Resistance: 1000 megohms min.

Physical

Housing: Heatproof resin, UL 94V-0
Contact: Copper Alloy
Plating: Tin over Nickel
Fitting Nail: Copper Alloy, Tin over Nickel plating

2.00mm (.079") Pitch CLIK-Mate™ Wire-to-Board PCB Receptacle

502494
Single Row
Right Angle

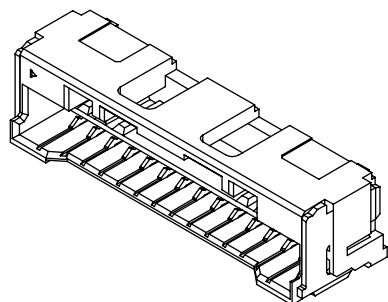

Circuits	Order No.	Lead-free
4	502494-0470	Yes
6	502494-0670	
8	502494-0870	
12	502494-1270	
13	502494-1370	
14	502494-1470	

Features and Benefits

- Sizes 4 to 14 circuits
- Audible "click," low insertion force and secure mating
- Tuning fork style contact design secures contact and avoids terminal stubbing
- Reinforced metal solder tabs enable housing wall support and secure PCB retention
- Flat area for pick-and-place is provided

Reference Information

Product Specification: PS-502443-001
Packaging: Embossed tape
Mates With: 502439
Designed In: Millimeters

Electrical

Voltage: 250V max.
Current: 3.0A max.
Contact Resistance: 20 milliohms max.
Dielectric Withstanding Voltage: 800V AC/1 min.
Insulation Resistance: 1000 Megohms min.

Physical

Housing: Heatproof resin, UL 94V-0
Contact: Copper Alloy
Plating: Tin over Nickel
Fitting Nail: Copper Alloy, Tin over Nickel plating

2.00mm (.079") Pitch

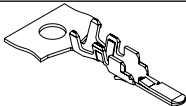
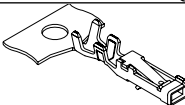
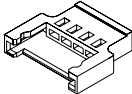
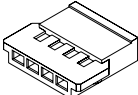
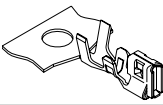
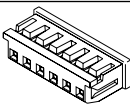
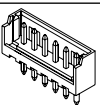
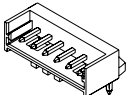
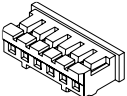
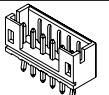
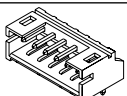
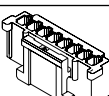
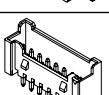
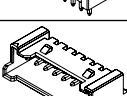
Pitch	Series		Tradename	Description
2.00mm (.079")	50012			Male Crimp Terminal
	50013			Female Crimp Terminal
	51006			Plug
	51005			Receptacle
	50212			Female Crimp Terminal
	51065		Micro-Latch™	Housing
	53253			Header
	53254			Header
	87369			Housing
	89400			Header
	89401			Header
	35507			Housing
	35362		Sherlock™	Header
	35363			Header



2.00 to 2.50mm (.079 to .098") Pitch PCB and Wire Connectors

2.00mm (.079") Pitch Wire-To-Wire Crimp Terminal

50012
Male

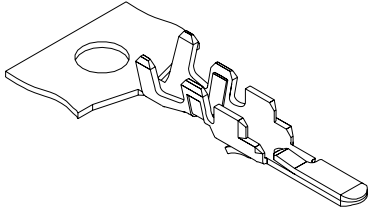

Order No.	Packaging	Lead-free
50012-8000	Reel	Yes
50012-8100	Bag	

Features and Benefits

- Locking tang for secure housing retention

Reference Information

Use With: 51006

Mates With: 50013

Designed In: Millimeters

Electrical

Voltage: 125V max.

Current:

AWG	24	26	28
	2.0A	1.5A	1.0A

Physical

Contact: Phosphor Bronze

Plating: Tin

Wire Range: 24 to 28 AWG

Insulation Diameter: 1.15mm dia. max.

Strip Length: 1.70 to 2.30mm

www.molex.com/customer.html?seriesNumber=50012

2.00mm (.079") Pitch Wire-to-Wire Crimp Terminal

50013
Female

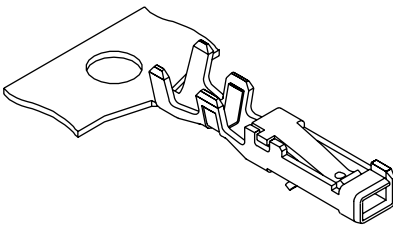

Order No.	Packaging	Lead-free
50013-8000	Reel	Yes
50013-8100	Bag	

Features and Benefits

- Spring beam design provides high pressure and small deflection for high vibration applications
- Locking tang for secure housing retention

Reference Information

Use With: 51005

Mates With: 50012

Designed In: Millimeters

Electrical

Voltage: 125V max.

Current:

AWG	24	26	28
	2.0A	1.5A	1.0A

Physical

Contact: Phosphor Bronze

Plating: Tin

Wire Range: 24 to 28 AWG

Insulation Diameter: 1.15mm dia. max.

Strip Length: 1.70 to 2.30mm

2.00mm (.079") Pitch Wire-to-Wire Plug

51006

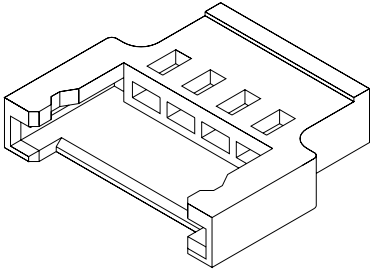

Circuits	Order No.
2	51006-0200
3	51006-0300
4	51006-0400
5	51006-0500

Features and Benefits

- Sizes 2 to 5 circuits
- Very thin design

Reference Information

Product Specification: PS-51005-001
 Packaging: Bag
 UL File No.: E29179
 CSA File No.: LR19980
 Mates With: 51005
 Use With: 50012
 Designed In: Millimeters

Electrical

Voltage: 125V max.
 Current:

AWG	24	26	28
	2.0A	1.5A	1.0A

Contact Resistance: 20 milliohms max.
 Dielectric Withstanding Voltage: 500V AC/1 min.
 Insulation Resistance: 100 Megohms min.

Physical

Housing: PBTP, UL 94V-0

www.molex.com/customer.html?seriesNumber=51006

2.00mm (.079") Pitch Wire-to-Wire Receptacle

51005

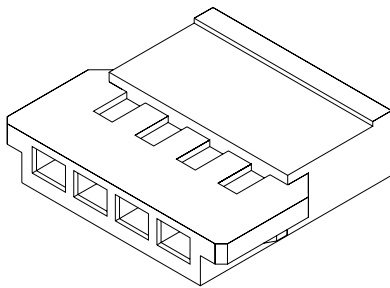

Circuits	Order No.
2	51005-0200
3	51005-0300
4	51005-0400
5	51005-0500

Features and Benefits

- Sizes 2 to 5 circuits
- Very thin design

Reference Information

Product Specification: PS-51005-001
 Packaging: Bag
 UL File No.: E29179
 CSA File No.: LR19980
 Mates With: 51006
 Use With: 50013
 Designed In: Millimeters

Electrical

Voltage: 125V max.
 Current:

AWG	24	26	28
	2.0A	1.5A	1.0A

Contact Resistance: 20 milliohms max.
 Dielectric Withstanding Voltage: 500V AC/1 min.
 Insulation Resistance: 100 Megohms min.

Physical

Housing: PBTP, UL 94V-0

2.00mm (.079") Pitch Wire-to-Board Crimp Terminal

50212

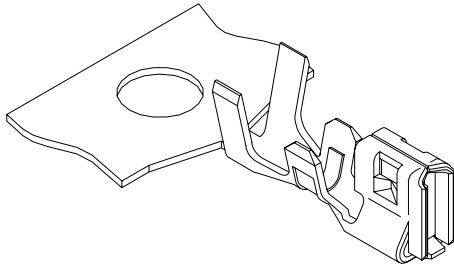

Order No.	Packaging	Lead-free
50212-8000	Reel	Yes
50212-8100	Bag	

Features and Benefits

- Locking tang provides terminal retention to housing

Reference Information

Use With: 35507, 51065, 51089, 51090 and 87369 housings
Designed In: Millimeters

Electrical

Voltage: 125V max.

Current:

AWG	24	26	28	30
	2.0A	1.5A	1.0A	0.5A

Physical

Contact: Phosphor Bronze

Plating: Tin

Wire Range: 24 to 30 AWG

Insulation Range: 1.40mm dia. max.

Strip Length: 1.3 to 1.8mm

www.molex.com/customer.html?seriesNumber=50212

2.00mm (.079") Pitch Micro-Latch™ Wire-to-Board Housing

51065

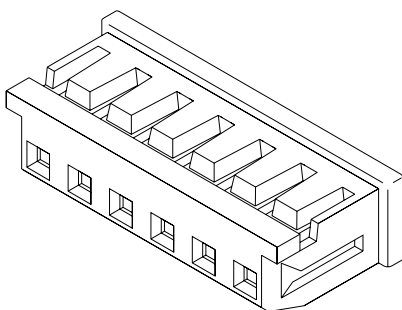

Features and Benefits

- Sizes 2 to 15 circuits
- Housing lance provides extra terminal retention
- Friction lock provides secure mating

Reference Information

Product Specification: PS-51065-016
Packaging: Bag
UL File No.: E29179
CSA File No.: LR19980
Mates With: 53253 and 53254
Use With: 50212
Designed In: Millimeters

Electrical

Voltage: 125V max.

Current:

AWG	24	26	28	30
	2.0A	1.5A	1.0A	0.5A

Contact Resistance: 20 milliohms max.

Dielectric Withstanding Voltage: 500V AC/1 min.

Insulation Resistance: 1000 Megohms min.

Physical

Housing: PBT, UL 94V-0

Circuits	Order No.
2	51065-0200
3	51065-0300
4	51065-0400
5	51065-0500
6	51065-0600

Circuits	Order No.
7	51065-0700
8	51065-0800
9	51065-0900
10	51065-1000
11	51065-1100

Circuits	Order No.
12	51065-1200
13	51065-1300
14	51065-1400
15	51065-1500

2.00mm (.079") Pitch Micro-Latch™ Wire-to-Board Header 53253 Vertical

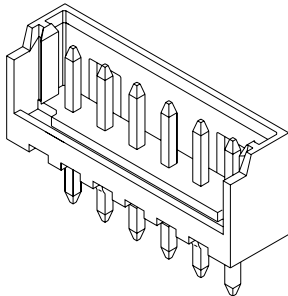

Features and Benefits

- Sizes 2 to 15 circuits
- Locking windows provide secure mating

Reference Information

Product Specification: PS-51065-016
Packaging: Tray
UL File No.: E29179
CSA File No.: LR19980
Mates With: 51065
Designed In: Millimeters

Electrical

Voltage: 125V max.
Current:

AWG	24	26	28	30
	2.0A	1.5A	1.0A	0.5A

Contact Resistance: 20 milliohms max.
Dielectric Withstanding Voltage: 500V AC/1 min.
Insulation Resistance: 1000 Megohms min.

Physical

Housing: Nylon, UL 94V-0
Contact: Brass
Plating: Tin

Circuits	Order No.	Lead-free
2	53253-0270	Yes
3	53253-0370	
4	53253-0470	
5	53253-0570	
6	53253-0670	
7	53253-0770	
8	53253-0870	

Circuits	Order No.	Lead-free
9	53253-0970	Yes
10	53253-1070	
11	53253-1170	
12	53253-1270	
13	53253-1370	
14	53253-1470	
15	53253-1570	

Circuits	Kink Position							
	1	2	3	4	5	N-2	N-1	N
3	x	x	x					
4	x	x	x	x				
5	x	x		x	x			
more than 6		x	x			x	x	

2.00mm (.079") Pitch Micro-Latch™ Wire-to-Board Header 53254 Right Angle

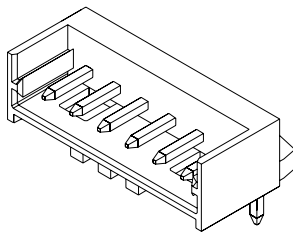

Features and Benefits

- Sizes 2 to 15 circuits
- Locking windows provide secure mating

Reference Information

Product Specification: PS-51065-016
Packaging: Tray
UL File No.: E29179
CSA File No.: LR19980
Mates With: 51065
Designed In: Millimeters

Electrical

Voltage: 125V max.
Current:

AWG	24	26	28	30
	2.0A	1.5A	1.0A	0.5A

Contact Resistance: 20 milliohms max.
Dielectric Withstanding Voltage: 500V AC/1 min.
Insulation Resistance: 1000 Megohms min.

Physical

Housing: Nylon, UL 94V-0
Contact: Brass
Plating: Tin

Circuits	Order No.	Lead-free
2	53254-0270	Yes
3	53254-0370	
4	53254-0470	
5	53254-0570	
6	53254-0670	
7	53254-0770	
8	53254-0870	

Circuits	Order No.	Lead-free
9	53254-0970	Yes
10	53254-1070	
11	53254-1170	
12	53254-1270	
13	53254-1370	
14	53254-1470	
15	53254-1570	

Circuits	Kink Position							
	1	2	3	4	5	N-2	N-1	N
3	x	x	x					
4	x	x	x	x				
5	x	x		x	x			
more than 6		x	x			x	x	

2.00mm (.079") Pitch Wire-to-Board Crimp Housing

87369 Single Row

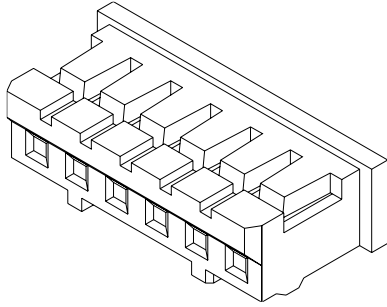

Features and Benefits

- Sizes 2 to 16 circuits
- Two friction locks
- Positive polarization
- Pull tab for easy insertion/extraction

Reference Information

Product Specification: PS-87369-0001, PS-87369-0002
 Packaging: Bag
 Use With: 50212 crimp terminal
 Mates With: 89400 and 89401 single row headers
 Designed In: Millimeters

Electrical

Voltage: 250V max.
 Current: 2.0A max.
 Contact Resistance: 40 milliohms max.
 Dielectric Withstanding Voltage: 500V AC/1 min.
 Insulation Resistance: 1000 Megohms min.

Physical

Housing: Nylon, UL 94V-0

Circuits	Order No.
2	87369-0200
3	87369-0300
4	87369-0400
5	87369-0500
6	87369-0600
7	87369-0700
8	87369-0800
9	87369-0900

Circuits	Order No.
10	87369-1000
11	87369-1100
12	87369-1200
13	87369-1300
14	87369-1400
15	87369-1500
16	87369-1600

www.molex.com/customer.html?seriesNumber=87369

2.00mm (.079") Pitch Wire-to-Board Header

89400 Vertical

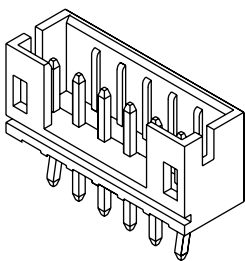

Features and Benefits

- Sizes 2 to 16 circuits
- Latch windows retain positive locks after mating
- Standoffs minimize flux retention
- Coined version available for positive pin retention to header
- For other color options, contact Molex

Reference Information

Product Specification: PS-87369-0001, PS-87369-0002
 Packaging: Bag
 UL File No.: E29179
 CSA File No.: LR19980A
 Mates With: 87369
 Designed In: Millimeters

Electrical

Voltage: 250V max.
 Current: 4.0A max.
 Contact Resistance: 40 milliohms max.
 Dielectric Withstanding Voltage: 500V AC/1 min.
 Insulation Resistance: 1000 Megohms min.

Physical

Housing: Nylon, UL 94V-0
 Contact: Brass
 Plating: Tin

Circuits	Order No.		Lead-free
	Standard	Coined	
2		89400-0220	Yes
3		89400-0320	
4	89400-0410	89400-0420	
5	89400-0510	89400-0520	
6	89400-0610	89400-0620	
7	89400-0710	89400-0720	
8	89400-0810	89400-0820	
9	89400-0910	89400-0920	

Circuits	Order No.		Lead-free
	Standard	Coined	
10	89400-1010	89400-1020	Yes
11	89400-1110	89400-1120	
12	89400-1210	89400-1220	
13	89400-1310	89400-1320	
14	89400-1410	89400-1420	
15	89400-1510	89400-1520	
16	89400-1610	89400-1620	

2.00mm (.079") Pitch Wire-to-Board Header

89401 Right Angle

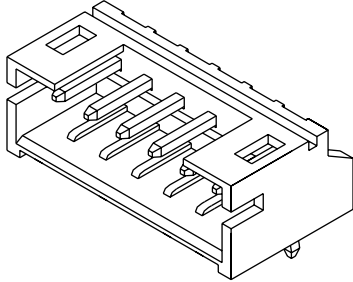

Features and Benefits

- Sizes 2 to 16 circuits
- Latch windows retain positive locks after mating
- Standoffs minimize flux retention
- Coined version for positive pin retention to header

Reference Information

Product Specification: PS-87369-0002
 Packaging: Bag
 UL File No.: E29179
 CSA File No.: LR19980A
 Mates With: 87369
 Designed In: Millimeters

Electrical

Voltage: 250V max.
 Current: 4.0A max.
 Contact Resistance: 40 milliohms max.
 Dielectric Withstanding Voltage: 500V AC/1 min.
 Insulation Resistance: 1000 Megohms min.

Physical

Housing: Nylon, UL 94V-0
 Contact: Brass
 Plating: Tin

Circuits	Order No.	Lead-free
2	89401-0210	Yes
3	89401-0310	
4	89401-0410	
5	89401-0510	
6	89401-0610	
7	89401-0710	
8	89401-0810	
9	89401-0910	

Circuits	Order No.	Lead-free
10	89401-1010	Yes
11	89401-1110	
12	89401-1210	
13	89401-1310	
14	89401-1410	
15	89401-1510	
16	89401-1610	

www.molex.com/customer.html?seriesNumber=89401

2.00mm (.079") Pitch Sherlock™ Wire-to-Board Housing

35507

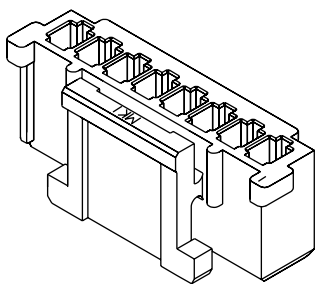

Features and Benefits

- Sizes 2 to 20 circuits
- Positive lock latch provides secure mating retention
- Housing lance ensures good terminal retention
- Compact low-profile design for space savings
- Polarizing end walls prevent mismatching
- Five color choices for circuit identification

Reference Information

Product Specification: PS-35507-003
 Packaging: Bag
 UL File No.: E29179
 CSA File No.: LR19980
 Mates With: 35362 and 35363 headers
 Use With: 50212 terminal
 Designed In: Millimeters

Electrical

Voltage: 125V max.
 Current: 2.0A max.
 Contact Resistance: 20 milliohms max.
 Dielectric Withstanding Voltage: 500V/1 min.
 Insulation Resistance: 1000 Megohms min.

Physical

Housing: PBT, UL 94V-0

Circuits	Order No.
2	35507-0200
3	35507-0300
4	35507-0400
5	35507-0500
6	35507-0600
7	35507-0700
8	35507-0800

Circuits	Order No.
9	35507-0900
10	35507-1000
11	35507-1100
12	35507-1200
13	35507-1300
14	35507-1400
15	35507-1500

Circuits	Order No.
16	35507-1600
17	35507-1700
18	35507-1800
19	35507-1900
20	35507-2000

2.00mm (.079") Pitch Sherlock™ Wire-to-Board Header 35362 Vertical

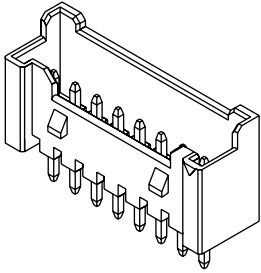

Circuits	Order No.	Lead-free
2	35362-0250	Yes
3	35362-0350	
4	35362-0450	
5	35362-0550	
6	35362-0650	

Features and Benefits

- Sizes 2 to 15 circuits
- Positive locking ribs provide secure mating retention
- Four-wall shroud with guide plate protects pins and facilitates mating
- Compact low-profile design for space savings
- Polarizing end walls prevent mismatching
- Five color choices for circuit identification

Reference Information

Product Specification: PS-35507-003
 Packaging: Bag
 UL File No.: E29179
 CSA File No.: LR19980
 Mates With: 35507 housing
 Designed In: Millimeters

Electrical

Voltage: 125V max.
 Current: 2.0A max.
 Contact Resistance: 20 milliohms max.
 Dielectric Withstanding Voltage: 500V AC/1 min.
 Insulation Resistance: 1000 Megohms min.

Physical

Housing: PA, UL 94V-0
 Contact: Brass
 Plating: Tin

Circuits	Order No.	Lead-free
7	35362-0750	Yes
8	35362-0850	
9	35362-0950	
11	35362-1150	
12	35362-1250	

Circuits	Order No.	Lead-free
13	35362-1350	Yes
14	35362-1450	
15	35362-1550	

2.00mm (.079") Pitch Sherlock™ Wire-to-Board Header 35363 Right Angle

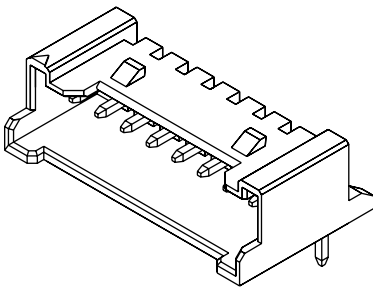

Circuits	Order No.	Lead-free
2	35363-0260	Yes
3	35363-0360	
4	35363-0460	
5	35363-0560	
6	35363-0660	
7	35363-0760	

Features and Benefits

- Sizes 2 to 20 circuits
- Positive locking ribs provide secure mating retention
- Four-wall shroud with guide plate protects pins and facilitates mating
- Compact low-profile design for space savings
- Polarizing end walls prevent mismatching
- Five color choices for circuit identification

Reference Information

Product Specification: PS-35507-003
 Packaging: Bag
 UL File No.: E29179
 CSA File No.: LR19980
 Mates With: 35507 housing
 Designed In: Millimeters

Electrical

Voltage: 125V max.
 Current: 2.0A max.
 Contact Resistance: 20 milliohms max.
 Dielectric Withstanding Voltage: 500V AC/1 min.
 Insulation Resistance: 1000 Megohms min.





Physical

Housing: PA, UL 94V-0
 Contact: Brass
 Plating: Tin

Circuits	Order No.	Lead-free
8	35363-0860	Yes
9	35363-0960	
10	35363-1060	
11	35363-1160	
12	35363-1260	
13	35363-1360	

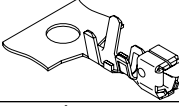
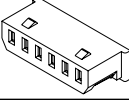
Circuits	Order No.	Lead-free
14	35363-1460	Yes
15	35363-1560	
17	35363-1760	
20	35363-2060	

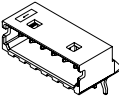
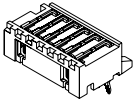
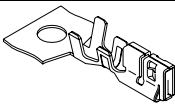
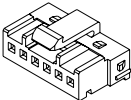
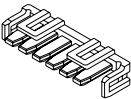
2.00mm (.079") Pitch

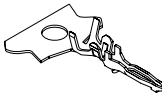
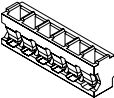
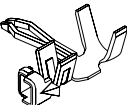
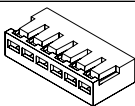
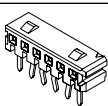
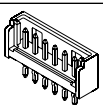
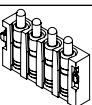
Pitch	Series		Tradename	Description
2.00mm (.079")	50011		MicroBlade™	Female Crimp Terminal
	51004			Housing
	53014			Header
	53015			Header
	53025			Header, Bottom Entry
	59370		iLock™	Female Crimp Terminal
	51216			Housing
	51217			Retainer
	55487			Header
	50034		Board-In	Crimp Terminal
	51015			Housing
	35021			Crimp Terminal
	35023			Housing
	52418		Board-to-Board	Receptacle
	53290			Header
	47282		Pogo Pin	Connector



2.00 to 2.50mm (.079 to .098") Pitch PCB and Wire Connectors

2.00mm (.079") Pitch MicroBlade™ Wire-to-Board Crimp Terminal

50011

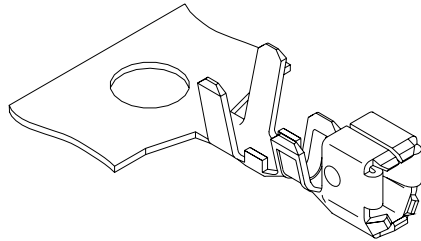

Order No.	Packaging	Lead-free
50011-8000	Reel	Yes
50011-8100	Bag	

Features and Benefits

- Box design provides 2 points of contact and terminal protection
- Locking tang for secure housing retention

Reference Information

Use With: 51004

Designed In: Millimeters

Electrical

Voltage: 125V max.

Current:

AWG	24	26	28	30
	2.0A	1.5A	1.0A	0.5A

Physical

Contact: Phosphor Bronze

Plating: Tin

Wire Range: 24 to 30 AWG

Insulation Range: 1.40mm dia. max.

Strip Length: 1.60 to 2.10mm

2.00mm (.079") Pitch MicroBlade™ Wire-to-Board Housing

51004

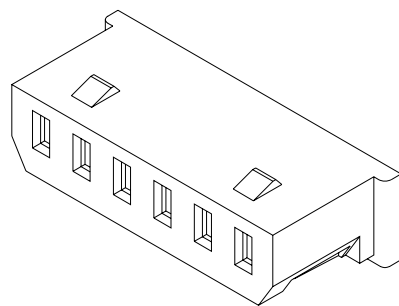

Features and Benefits

- Sizes 2 to 15 circuits
- Housing lance provides extra terminal retention
- Friction lock provides secure mating

Reference Information

Product Specification: PS-51004-002

Packaging: Bag

UL File No.: E29179

CSA File No.: LR19980

Mates With: 53014, 53015 and 53025

Use With: 50011

Designed In: Millimeters

Electrical

Voltage: 125V max.

Current: 2.0A max.

Contact Resistance: 20 milliohms max.

Dielectric Withstanding Voltage: 500V AC/1 min.

Insulation Resistance: 1000 Megohms min.

Physical

Housing: PBT, UL 94V-0

Circuits	Order No.
2	51004-0200
3	51004-0300
4	51004-0400
5	51004-0500
6	51004-0600
7	51004-0700
8	51004-0800

Circuits	Order No.
9	51004-0900
10	51004-1000
11	51004-1100
12	51004-1200
13	51004-1300
14	51004-1400
15	51004-1500

2.00mm (.079") Pitch MicroBlade™ Wire-to-Board Header 53014 Vertical

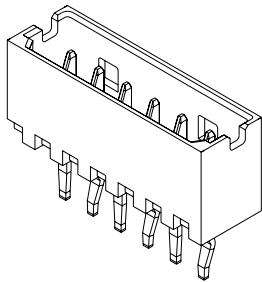

Features and Benefits

- Sizes 2 to 15 circuits
- Locking windows provide secure mating

Reference Information

Product Specification: PS-51004-002
Packaging: Bag
UL File No.: E29179
CSA File No.: LR19980
Mates With: 51004
Designed In: Millimeters

Electrical

Voltage: 125V max.
Current:

AWG	24	26	28	30
	2.0A	1.5A	1.0A	0.5A

Contact Resistance: 20 milliohms max.
Dielectric Withstanding Voltage: 500V AC/1 min.
Insulation Resistance: 1000 Megohms min.

Physical

Housing: Nylon, UL 94V-0
Contact: Phosphor Bronze
Plating: Tin

Circuits	Order No.	Lead-free
2	53014-0210	Yes
3	53014-0310	
4	53014-0410	
5	53014-0510	
6	53014-0610	
7	53014-0710	
8	53014-0810	

Circuits	Order No.	Lead-free
9	53014-0910	Yes
10	53014-1010	
11	53014-1110	
12	53014-1210	
13	53014-1310	
14	53014-1410	
15	53014-1510	

2.00mm (.079") Pitch MicroBlade™ Wire-to-Board Header 53015 Right Angle

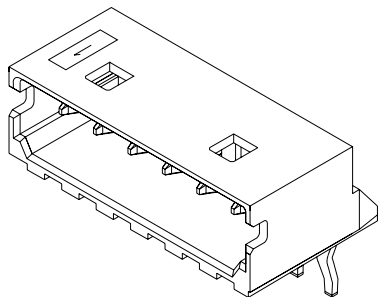

Features and Benefits

- Sizes 2 to 15 circuits
- Locking windows provides secure mating

Reference Information

Product Specification: PS-51004-002
Packaging: Bag
UL File No.: E29179
CSA File No.: LR19980
Mates With: 51004
Designed In: Millimeters

Electrical

Voltage: 125V max.
Current:

AWG	24	26	28	30
	2.0A	1.5A	1.0A	0.5A

Contact Resistance: 20 milliohms max.
Dielectric Withstanding Voltage: 500V AC/1 min.
Insulation Resistance: 1000 Megohms min.

Physical

Housing: Nylon, UL 94V-0
Contact: Phosphor Bronze
Plating: Tin

Circuits	Order No.	Lead-free
2	53015-0210	Yes
3	53015-0310	
4	53015-0410	
5	53015-0510	
6	53015-0610	
7	53015-0710	
8	53015-0810	

Circuits	Order No.	Lead-free
9	53015-0910	Yes
10	53015-1010	
11	53015-1110	
12	53015-1210	
13	53015-1310	
14	53015-1410	
15	53015-1510	

2.00mm (.079") Pitch MicroBlade™ Wire-to-Board Header

53025
Bottom Entry

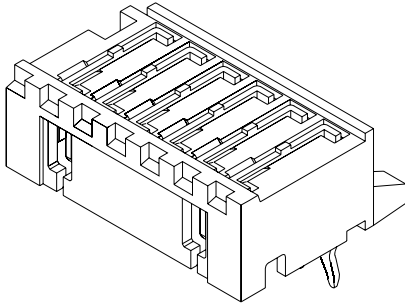

Circuits	Order No.	Lead-free
2	53025-0210	Yes
3	53025-0310	
4	53025-0410	
5	53025-0510	
6	53025-0610	
7	53025-0710	
8	53025-0810	
9	53025-0910	
10	53025-1010	

Features and Benefits

- Sizes 2 to 10 circuits
- Locking windows provide secure mating

Reference Information

Product Specification: PS-51004-002
Packaging: Tray
Mates With: 51004
Designed In: Millimeters

Electrical

Voltage: 125V max.
Current:

AWG	24	26	28	30
	2.0A	1.5A	1.0A	0.5A

Contact Resistance: 20 milliohms max.
Dielectric Withstanding Voltage: 500V AC/1 min.
Insulation Resistance: 1000 Megohms min.

Physical

Housing: Nylon, UL 94V-0
Contact: Phosphor Bronze
Plating: Tin

www.molex.com/product/microblade.html

2.00mm (.079") Pitch Wire-to-Board Crimp Terminal

59370
Female

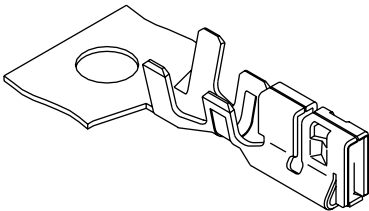

Order No.	Packaging	Lead-free
59370-8000	Reel	Yes
59370-8100	Bag	

Features and Benefits

- Two points of contact for good electrical reliability
- Double-box design for retainer support

Reference Information

Use With: 51216
Designed In: Millimeters

Electrical

Voltage: 250V max.
Current: 2.5A max.

Physical

Contact: Phosphor Bronze
Plating: Tin
Wire Range: 22 to 28 AWG
Insulation Diameter: 1.50mm (.059") max.
Strip Length: 1.60 to 2.00mm (.063 to .079")

2.00mm (.079") Pitch Wire-to-Board Housing

51216 Positive Lock

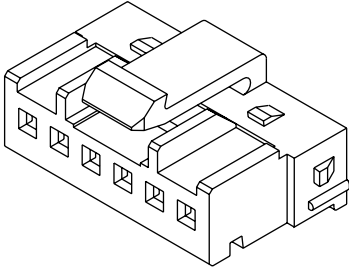

Features and Benefits

- Sizes 2 to 15 circuits
- Internal push-type positive lock provides secure retention, easy mating and latch protection during harness assembly
- Side ribs for latch protection and polarization
- Housing lance provides secure terminal retention

Reference Information

Product Specification: PS-51216-007
 Packaging: Bag
 Mates With: 55487 and 55755
 Use With: 59370 terminal and 51217 retainer
 Designed In: Millimeters

Electrical

Voltage: 250V max.
 Current: 2.5A max.
 Contact Resistance: 20 milliohms max.
 Dielectric Withstanding Voltage: 1000V AC/1 min.
 Insulation Resistance: 1000 Megohms min.

Physical

Housing: PBTP, UL 94V-0

Circuits	Order No.
2	51216-0200
4	51216-0400
5	51216-0500
6	51216-0600
7	51216-0700
8	51216-0800
9	51216-0900

Circuits	Order No.
10	51216-1000
11	51216-1100
12	51216-1200
13	51216-1300
14	51216-1400
15	51216-1500

www.molex.com/customer.html?seriesNumber=51216

2.00mm (.079") Pitch Wire-to-Board Retainer

51217

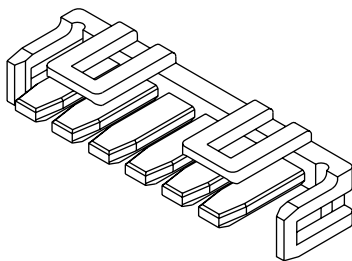

Features and Benefits

- Sizes 2 to 15 circuits
- Provides additional terminal retention
- Space-saving design snaps easily onto housing

Reference Information

Product Specification: PS-51216-007
 Packaging: Bag
 Use With: 51216
 Designed In: Millimeters

Physical

Housing: Gray PBTP, UL 94V-0

Circuits	Order No.
2	51217-0205
4	51217-0405
5	51217-0505
6	51217-0605
7	51217-0705
8	51217-0805
9	51217-0905

Circuits	Order No.
10	51217-1005
11	51217-1105
12	51217-1205
13	51217-1305
14	51217-1405
15	51217-1505

2.00mm (.079") Pitch Wire-to-Board Header

55487

**Vertical
Fully Shrouded**

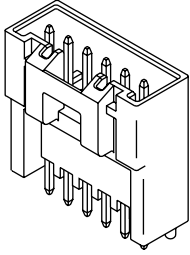

Features and Benefits

- Sizes 2 to 15 circuits
- Internal push-type positive lock provides secure retention, polarization and easy mating/unmating
- Potting type used for sealing components in white goods applications
- Polarization pegs assist placement

Reference Information

Product Specification: PS-51216-007
Packaging: Tray
Mates With: 51216
Designed In: Millimeters

Electrical

Voltage: 250V max.
Current: 2.5A max.
Contact Resistance: 20 milliohms max.
Dielectric Withstanding Voltage: 1000V AC/1 min.
Insulation Resistance: 1000 Megohms min.

Physical

Housing: Nylon, UL 94V-0
Contact: Brass
Plating: Tin over Copper

Circuits	Order No.	Lead-free
2	55487-0219	Yes
3	55487-0319	
4	55487-0419	
5	55487-0519	
6	55487-0619	
7	55487-0719	
8	55487-0819	

Circuits	Order No.	Lead-free
9	55487-0919	Yes
10	55487-1019	
11	55487-1119	
12	55487-1219	
13	55487-1319	
14	55487-1419	
15	55487-1519	

www.molex.com/customer.html?seriesNumber=55487

2.00mm (.079") Pitch Board-In Connector Crimp Terminal

50034

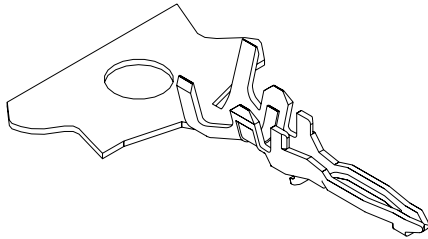

Features and Benefits

- Locking tang secures terminal to housing

Reference Information

Use With: 51015
Designed In: Millimeters

Electrical

Voltage: 125V max.
Current:

AWG	26	28	30
	2.0A	1.5A	1.0A

Physical

Contact: Phosphor Bronze
Plating: Tin
Wire Range: 26 to 30 AWG
Insulation Range: 1.40mm dia. max.
Strip Length: 1.40 to 1.90mm

Order No.	Packaging	Lead-free
50034-8000	Reel	Yes
50034-8100	Bag	

2.00mm (.079") Pitch Board-In Connector Housing

51015

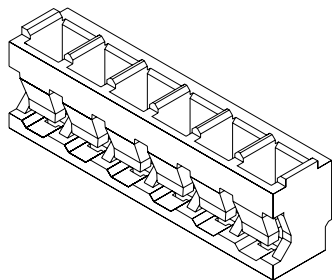

Features and Benefits

- Sizes 2 to 15 circuits
- Low profile of 3.8mm
- Locking windows secure terminal to housing

Reference Information

Product Specification: PS-51015-002
 Packaging: Bag
 Use With: 50034
 Designed In: Millimeters

Electrical

Voltage: 125V max.
 Current:

AWG	26	28	30
	2.0A	1.5A	1.0A

Dielectric Withstanding Voltage: 500V AC/1 min.
 Insulation Resistance: 1000 Megohms min.

Physical

Housing: Nylon, UL 94V-0

Circuits	Order No.
2	51015-0200
3	51015-0300
4	51015-0400
5	51015-0500
6	51015-0600
7	51015-0700
8	51015-0800

Circuits	Order No.
9	51015-0900
10	51015-1000
11	51015-1100
12	51015-1200
13	51015-1300
14	51015-1400
15	51015-1500

www.molex.com/product/board_in.html

2.00/2.50mm (.079/.098") Board-In Connector Crimp Terminal

35021
 Right Angle

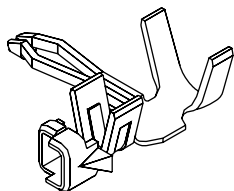

Features and Benefits

- Very low profile
- Wide wire range (24 to 30 AWG)
- Locking tab secures terminal to housing
- Diamond-shaped PC tail ensures secure PCB retention

Reference Information

Packaging: Reel
 UL File No.: E29179
 CSA File No.: LR19980
 Use With: 35023 housings
 Designed In: Millimeters

Electrical

Voltage: 125V max.
 Current:

AWG	24	26	28	30
	2.5A	1.5A	1.0A	0.5A

Physical

Contact: See Table
 Plating: See Table
 Wire Range: 24 to 30 AWG
 Insulation Range: 35023—1.50mm dia. max. (24 AWG)

Order No.	Contact Material	Plating	Lead-free
35021-1201	Brass	Pre-Tin Post-Tin	Yes
35021-1301	Phosphor Bronze		
35021-1360			

2.00mm (.079") Pitch Board-In Connector Housing

35023 Right Angle

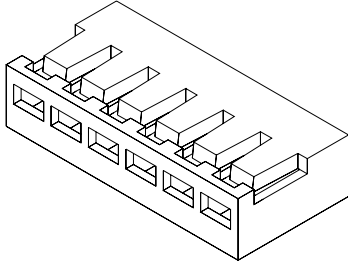

Features and Benefits

- Sizes 2 to 16 circuits
- Low profile (2.85mm)
- Terminal locking window
- Solders directly to PCB

Reference Information

Product Specification: PS-35023-001
 Packaging: Bag
 UL File No.: E29179
 CSA File No.: LR19980
 Use With: 35021 and 35044 terminal
 Designed In: Millimeters

Electrical

Voltage: 125V max.
 Current: 2.5A max.
 Contact Resistance: 5 milliohms max.
 Dielectric Withstanding Voltage: 1000V AC/1 min.
 Insulation Resistance: 1000 Megohms min.

Physical

Housing: Nylon, UL 94V-0

Circuits	Order No.
2	35023-0002
3	35023-0003
4	35023-0004
5	35023-0005
6	35023-0006

Circuits	Order No.
7	35023-0007
8	35023-0008
9	35023-0009
10	35023-0010
11	35023-0011

Circuits	Order No.
12	35023-0012
13	35023-0013
14	35023-0014
16	35023-0016

2.00mm (.079") Pitch Board-to-Board Receptacle

52418
Right Angle

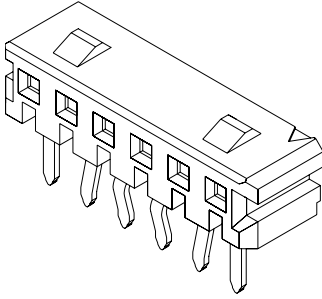

Features and Benefits

- Sizes 3 to 20 circuits

Reference Information

Production Specification: PS-52418-003
Packaging: Tray and Tube
Mates With: 53290
Designed In: Millimeters

Electrical

Voltage: 125V max.
Current: 1.5A max.
Contact Resistance: 20 milliohms max.
Dielectric Withstanding Voltage: 500V AC/1 min.
Insulation Resistance: 1000 Megohms min.

Physical

Housing: Glass-filled PBT, UL 94V-0
Contact: Phosphor Bronze
Plating: Tin

Circuits	Order No.		Lead-free
	Tray	Tube	
3	52418-0310	52418-0390	Yes
4	52418-0410	52418-0490	
5	52418-0510	52418-0590	
6	52418-0610	52418-0690	
7	52418-0710	52418-0790	
8	52418-0810		
9	52418-0910	52418-0990	
10	52418-1010		
11	52418-1110	52418-1190	

Circuits	Order No.		Lead-free
	Tray	Tube	
12	52418-1210	52418-1290	Yes
13	52418-1310	52418-1390	
14	52418-1410	52418-1490	
15	52418-1510	52418-1590	
16	52418-1610	52418-1690	
17	52418-1710	52418-1790	
18	52418-1810	52418-1890	
19	52418-1910		
20	52418-2010	52418-2090	

www.molex.com/customer.html?seriesNumber=52418

2.00mm (.079") Pitch Board-to-Board Plug

53290
Vertical

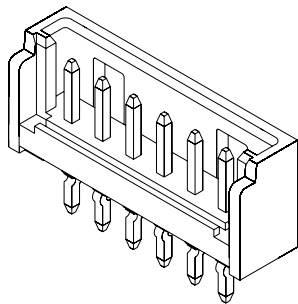

Features and Benefits

- Sizes 3 to 20 circuits
- Friction lock and kinked tails provide additional mating and PCB retention

Reference Information

Production Specification: PS-52418-003
Packaging: Tube (XX71)/Tray (XX80)
Mates With: 52418
Designed In: Millimeters

Electrical

Voltage: 125V max.
Current: 1.5A max.
Contact Resistance: 20 milliohms max.
Dielectric Withstanding Voltage: 500V AC/1 min.
Insulation Resistance: 1000 Megohms min.

Physical

Housing: Glass-filled PBT, UL 94V-0
Contact: Brass
Plating: Tin

Circuits	Order No.		Lead-free
	Without Kinked Tail	With Kinked Tail	
3	53290-0371	53290-0380	Yes
4		53290-0480	
5	53290-0571	53290-0580	
6	53290-0671	53290-0680	
7		53290-0780	
8	53290-0871	53290-0880	
9	53290-0971	53290-0980	
10	53290-1071	53290-1080	
11	53290-1171	53290-1180	

Circuits	Order No.		Lead-free
	Without Kinked Tail	With Kinked Tail	
12	53290-1271	53290-1280	Yes
13	53290-1371	53290-1380	
14	53290-1471	53290-1480	
15	53290-1571	53290-1580	
16		53290-1680	
17	53290-1771	53290-1780	
18	53290-1871	53290-1880	
19		53290-1980	
20	53290-2071	53290-2080	

www.molex.com/customer.html?seriesNumber=53290



2.00mm (.079") Pitch Dual Row Custom Headers

Features and Benefits

- Sizes 4 to 50 circuits
- End-to-end stackable versions for modular configurations
- Optional voided pin version for polarization to the mating part available
- Optional kinked PC tail are available for through hole and right angle versions
- Available with and without locating pegs
- Pick-and-place cap versions available
- Tape and reel packaging options available

Reference Information

Product Specification: PS-87761-100
 Packaging: Tray, tube or bag
 Mates With: Milli-Grid 2.00mm Receptacles
 Designed In: Millimeters

Electrical

Voltage: 125V
 Current: 2.0A
 Contact Resistance: 20 milliohms max.
 Dielectric Withstanding Voltage: 500V
 Insulation Resistance: 50 Megohms min.

Physical

Housing: Black high-temperature nylon, UL94V-0
 Contact: Copper Alloy, 0.50mm square
 Plating: Tin, Gold Flash, 10µ" Select Gold, 15µ" Select Gold and 30µ" Select Gold
 PCB Thickness: 1.60+/-0.10mm

2.00 to 2.50mm (.079 to .098") Pitch PCB and Wire Connectors

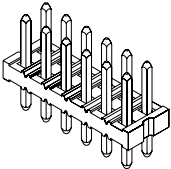
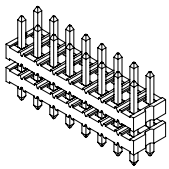
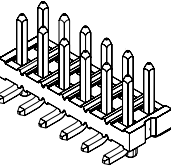
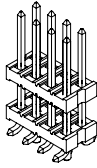
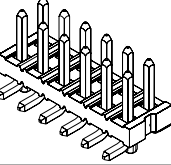
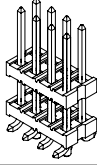
	Single Body Options	Series		Dual Body Options	Series
	Vertical Through Hole	87758		Vertical Through Hole	87761
	Vertical SMT	87759		Vertical SMT	87762
	Vertical SMT with Pegs	87759		Vertical SMT with Pegs	87762

Contact factory for 2mm single row headers
 Contact factory for standard versions

2.00mm (.079") Pitch Pogo Pin Connector

47282

Right Angle, Surface Mount

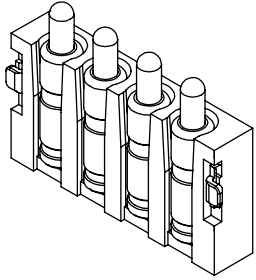

Circuits	Order No.	Lead-free
4	47282-0001	Yes

Features and Benefits

- Speaker, battery, vibrator or antenna contact applications
- Small footprint saves PCB real estate and provides more flexible design
- SMT lead-free configuration
- Initial height at 6.60mm (.260") and full-stroke working height at 5.60mm (.220")

Reference Information

Product Specification: PS-47282-001

Packaging: Tape on reel

Designed In: Millimeters

Electrical

Voltage: 12V DC

Current: 3.0A

Contact Resistance: 30 milliohms max.

Dielectric Withstanding Voltage: 500V DC

Insulation Resistance: 100 Megohms min.

Mechanical

Normal Force: 0.83N

Durability: 20,000 cycles

Physical

Housing: Glass-filled high-temperature thermoplastic, UL 94V-0

Contact: Copper Alloy

Plating: Contact Area—40µ" Gold





Solder Tail Area—Gold

Underplating: Nickel

2.50mm (.098") Pitch

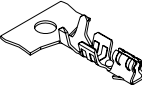
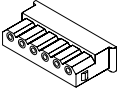
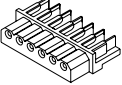
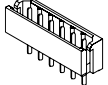
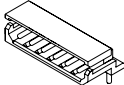

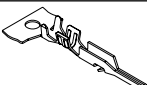
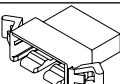
2.00 to 2.50mm (.079 to .098") Pitch PCB and Wire Connectors

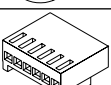
Pitch	Series		Tradename	Description
2.50mm (.098")	5263		Mini-SPOX™	Female Crimp Terminal
	5264-N			Housing
	42219			IDT Connector
	5267-NA			Header
	5268-NA			Header
	42249			Header
	42267			Header
	5241			Male Crimp Terminal
	5240			Plug Housing
	45579			SPOX BMI™
	45578		PCB Header	
	5051-N		KK®	Crimp Terminal Housing

2.50mm (.098") Pitch SPOX™ Wire-to-Board Crimp Terminal 5263 Spring Box

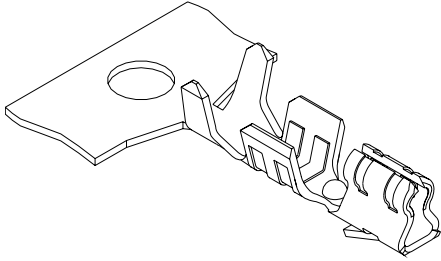

Features and Benefits

- Very low profile
- Anti-fishhooking design
- Box protects pin contact area from contamination during handling

Reference Information

Use With: 5264 housings
Designed In: Millimeters

Electrical

Voltage: 250V max.

Current:

AWG	22	24	26	28
	3.0A	2.5A	2.0A	1.5A

Physical

Contact: Phosphor Bronze
Plating: Tin

Order No.	Packaging	Engineering No.	Wire Range AWG	Insulation Diameter	Lead-free
08-70-1039	Reel	5263PBT	22-28	1.90 (.075) max.	Yes
08-70-1040	Bag	5263PBTL			

2.50mm (.098") Pitch SPOX™ Wire-to-Board Crimp Terminal Housing 5264-N Shrouded

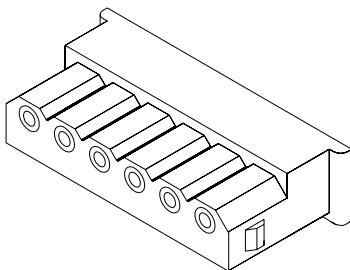

Features and Benefits

- Sizes 2 to 15 circuits
- Very low profile
- Molded-in pull tabs
- Friction lock

Reference Information

Product Specification: PS-5264-001

Packaging: Bag

UL File No.: E29179

CSA File No.: LR19980

Mates With: 5267-NA-X and 5268-NA

Use With: 5263 terminals

Designed In: Millimeters

Electrical

Voltage: 250V max.

Current:

AWG	22	24	26	28
	3.0A	2.5A	2.0A	1.5A

Contact Resistance: 20 milliohms max.

Dielectric Withstanding Voltage: 1000V AC/1 min.

Insulation Resistance: 1000 Megohms min.

Physical

Housing: Nylon, UL 94V-0

Circuits	Order No.
2	50-37-5023
3	50-37-5033
4	50-37-5043
5	50-37-5053
6	50-37-5063
7	50-37-5073
8	50-37-5083

Circuits	Order No.
9	50-37-5093
10	50-37-5103
11	50-37-5113
12	50-37-5123
13	50-37-5133
14	50-37-5143
15	50-37-5153

2.50mm (.098") Pitch SPOX™ Wire-to-Board Connector

42219 IDT Spring Box

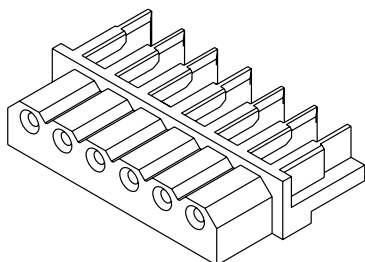

Features and Benefits

- In-line IDT termination
- Integral crimped strain relief
- Connections supplied on terminal carrier strip for application tooling

Reference Information

Product Specification: PS-42219-0001
Packaging: Bag
UL File No.: E29179
CSA File No.: LR19980
Mates With: 42249 and 42267 headers
Designed In: Millimeters

Electrical

Voltage: 250V max.
Current: 3.0A max.
Contact Resistance: 10 milliohms max.
Dielectric Withstanding Voltage: 1000V AC/1 min.
Insulation Resistance: 1000 Megohms min.

Physical

Housing: Glass-filled PBT, UL 94V-0
Contact: Phosphor Bronze
Plating: Tin
Wire Accommodation: 24 AWG solid or stranded with topcoat or 26 AWG stranded with topcoat

Circuits	Order No.	Lead-free
2	22-43-3020	Yes
3	22-43-3030	
4	22-43-3040	
5	22-43-3050	
6	22-43-3060	
7	22-43-3070	
8	22-43-3080	

Circuits	Order No.	Lead-free
9	22-43-3090	Yes
10	22-43-3100	
11	22-43-3110	
12	22-43-3120	
13	22-43-3130	
14	22-43-3140	
15	22-43-3150	

2.50mm (.098") Pitch SPOX™ Wire-to-Board Header

5267-NA-X Vertical Fully Shrouded

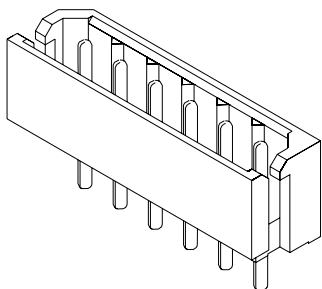

Features and Benefits

- Sizes 2 to 12 circuits
- Polarized
- Friction lock

Reference Information

Product Specification: PS-5264-001
Packaging: Bag
UL File No.: E29179
CSA File No.: LR19980
Mates With: 5264-N
Designed In: Millimeters

Electrical

Voltage: 250V max.
Current:

AWG	22	24	26	28
	3.0A	2.5A	2.0A	1.5A

Contact Resistance: 20 milliohms max.
Dielectric Withstanding Voltage: 1000V AC/1 min.
Insulation Resistance: 1000 Megohms min.

Physical

Housing: Nylon, UL 94V-0
Contact: Brass
Plating: Tin over Copper

Circuits	Order No.	Lead-free
2	99-99-0986	Yes
3	99-99-0987	
4	99-99-0988	
5	99-99-0989	
6	99-99-0990	
7	99-99-0991	

Circuits	Order No.	Lead-free
8	99-99-0992	Yes
9	99-99-0993	
10	99-99-0994	
11	99-99-0995	
12	99-99-0996	

2.50mm (.098") Pitch SPOX™ Wire-to-Board Header

5268-NA
Right Angle
Fully Shrouded

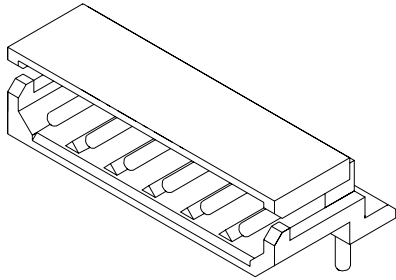

Features and Benefits

- Sizes 2 to 10 circuits
- Polarized
- Friction lock

Reference Information

Product Specification: PS-5264-001
Packaging: Bag
UL File No.: E29179
CSA File No.: LR19980
Mates With: 5264-N
Designed In: Millimeters

Electrical

Voltage: 250V max.
Current:

AWG	22	24	26	28
	3.0A	2.5A	2.0A	1.5A

Contact Resistance: 20 milliohms max.
Dielectric Withstanding Voltage: 1000V AC/1 min.
Insulation Resistance: 1000 Megohms min.

Physical

Housing: Nylon, UL 94V-0
Contact: Brass
Plating: Tin over Copper

Circuits	Order No.	Lead-free
2	22-05-7025	Yes
3	22-05-7035	
4	22-05-7045	
5	22-05-7055	
6	22-05-7065	

Circuits	Order No.	Lead-free
7	22-05-7075	Yes
8	22-05-7085	
9	22-05-7095	
10	22-05-7105	

www.molex.com/product/spox.html

2.50mm (.098") Pitch SPOX™ Wire-to-Board Header

42249
Shrouded, Staggered Footprint

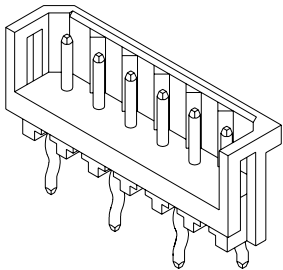

Features and Benefits

- Polarized to mating connector
- Staggered footprint prevents solder bridging
- Standard kinked PC tails for retention to PC board

Reference Information

Product Specification: PS-42219-0001
Packaging: Bag
UL File No.: E29179
CSA File No.: LR19980
Mates With: 42219 connectors
Designed In: Millimeters

Electrical

Voltage: 250V max.
Current: 3.0A max.
Contact Resistance: 10 milliohms max.
Dielectric Withstanding Voltage: 1000V AC/1 min.
Insulation Resistance: 1000 Megohms min.

Physical

Housing: Glass-filled PBT, UL 94V-0
Contact: Brass
Plating: Tin over Nickel

Circuits	Order No.	Lead-free
2	22-43-6020	Yes
3	22-43-6030	
4	22-43-6040	
5	22-43-6050	
6	22-43-6060	
7	22-43-6070	
8	22-43-6080	

Circuits	Order No.	Lead-free
9	22-43-6090	Yes
10	22-43-6100	
11	22-43-6110	
12	22-43-6120	
13	22-43-6130	
14	22-43-6140	
15	22-43-6150	

2.50mm (.098") Pitch SPOX™ Wire-to-Board Header

42267
Shrouded, In-Line Footprint

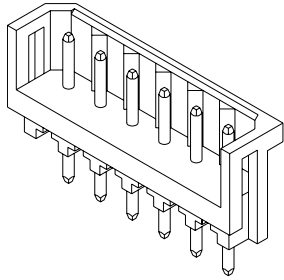

Features and Benefits

- Polarized to mating connector
- Standard kinked PC tails for retention to PC board

Reference Information

Product Specification: PS-42219-0001
Packaging: Bag
UL File No.: E29179
CSA File No.: LR19980
Mates With: 42219 connectors
Designed In: Millimeters

Electrical

Voltage: 250V max.
Current: 3.0A max.
Contact Resistance: 10 milliohms max.
Dielectric Withstanding Voltage: 1000V AC/1 min.
Insulation Resistance: 1000 Megohms min.

Physical

Housing: Glass-filled PBT, UL 94V-0
Contact: Brass
Plating: Tin over Nickel

Circuits	Order No.	Lead-free
2	22-43-8020	Yes
3	22-43-8030	
4	22-43-8040	
5	22-43-8050	
6	22-43-8060	
7	22-43-8070	
8	22-43-8080	

Circuits	Order No.	Lead-free
9	22-43-8090	Yes
10	22-43-8100	
11	22-43-8110	
12	22-43-8120	
13	22-43-8130	
14	22-43-8140	
15	22-43-8150	

www.molex.com/customer.html?seriesNumber=42267

2.50mm (.098") Pitch SPOX™ Wire-to-Wire Male Crimp Terminal

5241

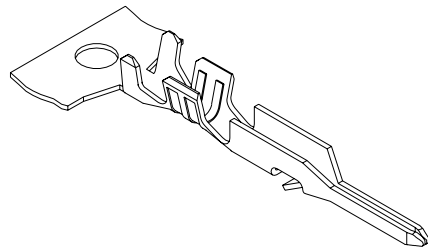

Features and Benefits

- Rigid contact

Reference Information

Mates With: 5103 terminals
Use With: 5102-N and 51171
Designed In: Millimeters

Electrical

Voltage: 250V max.
Current:

AWG	22	24	26	28
	3.0A	2.5A	2.0A	1.5A

Physical

Contact: Brass
Plating: Tin

Order No.	Packaging	Wire Gauge AWG	Insulation Diameter	Lead-free
08-70-0102	Reel	22-28	1.90mm max.	Yes
08-70-0103	Bag			

Recommended wire range assumes stranded wire

2.50mm (.098") Pitch SPOX™ Wire-to-Wire Plug Housing 5240

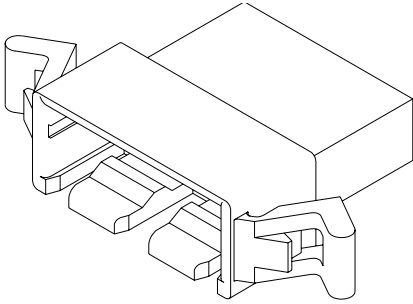

Features and Benefits

- Sizes 2 to 12 circuits
- With and without mounting ears

Reference Information

Product Specification: PS-51191-003, PS-51191-0035
 Packaging: Bag
 UL File No.: E29179
 CSA File No.: LR19980
 Mates With: 5102-N and 51191 housings
 Use With: 5241 terminals
 Designed In: Millimeters

Electrical

Voltage: 250V max.
 Current:

AWG	22	24	26	28
	3.0A	2.5A	2.0A	1.5A

Contact Resistance: 20 milliohms max.
 Dielectric Withstanding Voltage: 1000V AC/1 min.
 Insulation Resistance: 1000 Megohms min.

Physical

Housing: Nylon, UL 94V-0

Circuits	Order No.	
	With Ears	Without Ears
2	29-11-0022	29-11-0023
3	29-11-0032	29-11-0033
4	29-11-0042	29-11-0043
5	29-11-0052	29-11-0053
6	29-11-0062	29-11-0063
7	29-11-0072	29-11-0073

Circuits	Order No.	
	With Ears	Without Ears
8	29-11-0082	29-11-0083
9	29-11-0092	29-11-0093
10	29-11-0102	29-11-0103
11	29-11-0112	29-11-0113
12	29-11-0122	29-11-0123

www.molex.com/product/spox.html

2.50mm (.098") Pitch SPOX BMI™ Crimp Terminal Housing Receptacle 45579 Panel Mount

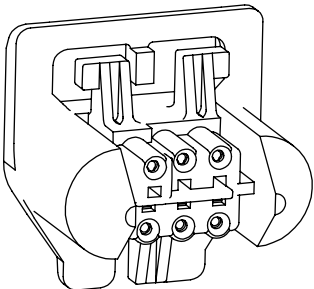

Features and Benefits

- Panel mounting feature permits up to 3.00mm (.120") misalignment in horizontal and vertical directions permitting blind-mating of products as connectors can self-align
- First-mate/last-break circuits provide sequential engagement of contacts for design flexibility
- Robust alignment features virtually eliminate contact damage

Reference Information

Product Specification: PS-45579-001
 UL File No.: E29179
 CSA File No.: LR19980
 Mates With: 45578 and 45626
 Use With: 5263

Mechanical

Locking: None

Physical

Housing: Unfilled polyester, UL 94V-0

Order No.	Lead-free
45579-0001	Yes

2.50mm (.098") Pitch SPOX BMI™ Wire-to-Wire and Wire-to-Board PCB Header

45578
Vertical

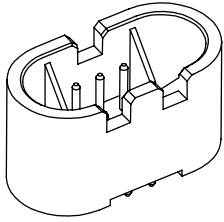

Order No.	Plating	Underplating	Lead-free
45578-0001	Tin	Nickel	Yes
45578-0002			

Features and Benefits

- Headers are molded in LCP high-temperature plastic, which meets lead-free processing requirements
- Robust alignment features virtually eliminate contact damage

Reference Information

Product Specification: PS-45579-001
UL File No.: E29179
CSA File No.: LR19980
Mates With: 45579

Electrical

Voltage: 250V
Current: 3.0A max.
Contact Resistance: 20 milliohms max.

Mechanical

Durability: 25 cycles

Physical

Housing: Glass-filled LCP, UL 94V-0
Contact: Copper Alloy

www.molex.com/product/wb/spoxbmi.html

2.50mm (.098") Pitch KK® Crimp Terminal Housing

5051-N
Polarized

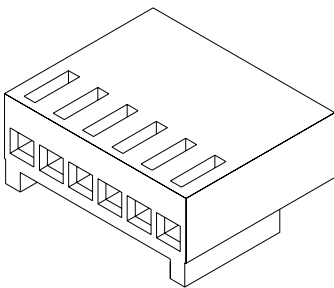

Features and Benefits

- Sizes 2 to 15 circuits
- Molded friction lock
- Optional locking ramp version
- Stackable end-to-end

Reference Information

Product Specification: PS-5051-004
Packaging: Bag
UL File No.: E29179
CSA File No.: LR19980
Mates With: 5045-NA and 5046-NA
Use With: 5159 terminals
Designed In: Millimeters

Electrical

Voltage: 250V max.
Current: 3.0A max.
Contact Resistance: 20 milliohms max.
Dielectric Withstanding Voltage: 1000V AC/1 min.
Insulation Resistance: 1000 Megohms min.

Physical

Housing: Nylon, UL 94V-0

Circuits	Order No.
2	22-01-1022
3	22-01-1032
4	22-01-1042
5	22-01-1052
6	22-01-1062
7	22-01-1072
8	22-01-1082

Circuits	Order No.
9	22-01-1092
10	22-01-1102
11	22-01-1112
12	22-01-1122
13	22-01-1132
14	22-01-1142
15	22-01-1152

2.50mm (.098") Pitch

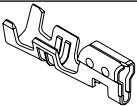
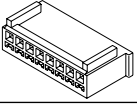
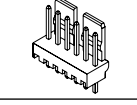
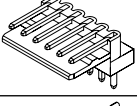
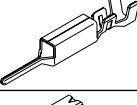
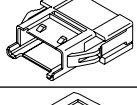
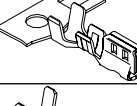
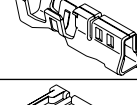
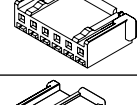
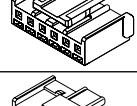
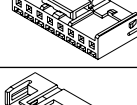
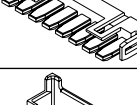
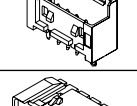
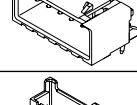
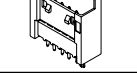
Pitch	Series		Tradename	Description
2.50mm (.098")	50802		Mini-Latch™	Female Crimp Terminal
	51191			Receptacle
	5045			Header
	5046			Header
	50837		Mini-Lock™	Male Crimp Terminal
	51198			Plug
	50351			Crimp Terminal
	50752			Female Crimp Terminal
	51102			Housing
	51103			Housing
	51163			Housing
	51164			Terminal Retainer
	53375			Header
	53426			Header
	53517		Header	

C
2.00 to 2.50mm (.079 to .098") Pitch PCB and Wire Connectors

2.50mm (.098") Pitch Mini-Latch™ Wire-to-Board and Wire-to-Wire Crimp Terminal

50802
Female

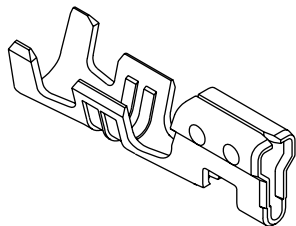

Order No.	Packaging	Lead-free
50802-9001	Reel	Yes
50802-9101	Bag	
50802-8000	Reel	
50802-8100	Bag	

Features and Benefits

- Box design protects contact area
- Four points of contact for good signal integrity

Reference Information

Packaging: Reel
Use With: 51191
Designed In: Millimeters

Electrical

Voltage: 250V max.
Current: 3.0A max.

Physical

Contact: 50802-8XXX Phosphor Bronze
50802-9XXX Brass
Plating: Tin
Wire Range: 22 to 28 AWG
Insulation Diameter:
1.15 to 1.90mm (.045 to .075") dia.
Strip Length: 2.60 to 3.20mm (.102 to .126")

2.50mm (.098") Pitch Mini-Latch™ Wire-to-Board and Wire-to-Wire Receptacle

51191

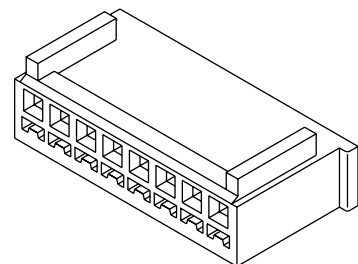

Features and Benefits

- Sizes 2 to 15 circuits
- Guide rails facilitate mating
- Friction lock for mating retention
- Molded pull-tabs enable easy un-mating

Reference Information

Product Specification: Wire-to-Board—PS-51191-002
Wire-to-Wire—PS-51191-003

Packaging: Bag
UL File No.: E29179
Mates With: 5045, 5046 and 5240
Use With: 50802
Designed In: Millimeters

Electrical

Voltage: 250V max.
Current: 3.0A max.
Contact Resistance: 20 milliohms max.
Dielectric Withstanding Voltage: 1000V AC/1 min.
Insulation Resistance: 1000 Megohms min.

Physical

Housing: Nylon, UL 94V-0

Circuits	Order No.
2	51191-0200
3	51191-0300
4	51191-0400
5	51191-0500
6	51191-0600
7	51191-0700
8	51191-0800

Circuits	Order No.
9	51191-0900
10	51191-1000
11	51191-1100
12	51191-1200
13	51191-1300
14	51191-1400
15	51191-1500

2.50mm (.098") Pitch Wire-to-Board Header

5045 Vertical, Square Pin Polarizing Lock

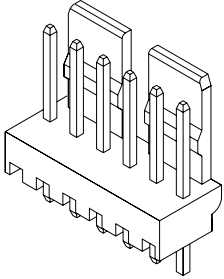

Features and Benefits

- Sizes 2 to 20 circuits
- 0.64mm (.025") square wire pins

Reference Information

Product Specification: PS-5051-004, PS-51191-002
 Packaging: Bag
 UL File No.: E29179
 CSA File No.: LR19980
 Mates With: 5051 and 51191
 Designed In: Millimeters

Electrical

Voltage: 250V max.
 Current:

AWG	22	24	26	28
	3.0A	2.5A	2.0A	1.5A

Contact Resistance: 20 milliohms max.
 Dielectric Withstanding Voltage: 1000V AC/1 min.
 Insulation Resistance: 1000 Megohms min.

Physical

Housing: Nylon, UL 94V-0
 Contact: Brass
 Plating: Tin over Copper

Circuits	Order No.	Lead-free
2	22-04-1021	Yes
3	22-04-1031	
4	22-04-1041	
5	22-04-1051	
6	22-04-1061	
7	22-04-1071	
8	22-04-1081	
9	22-04-1091	
10	22-04-1101	
11	22-04-1111	

Circuits	Order No.	Lead-free
12	22-04-1121	Yes
13	22-04-1131	
14	22-04-1141	
15	22-04-1151	
16	22-04-1161	
17	22-04-1171	
18	22-04-1181	
19	22-04-1191	
20	22-04-1201	

2.50mm (.098") Pitch Mini-Latch™ Wire-to-Board Header

5046 Right Angle Friction Lock

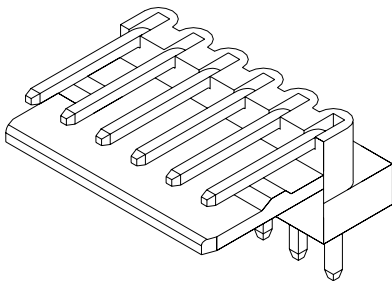

Features and Benefits

- Sizes 2 to 15 circuits
- 0.64mm (.025") square wire pins

Reference Information

Product Specification: PS-5051-004, PS-51191-002
 Packaging: Bag
 UL File No.: E29179
 CSA File No.: LR19980
 Mates With: 5051 and 51191
 Designed In: Millimeters

Electrical

Voltage: 250V max.
 Current:

AWG	22	24	26	28
	3.0A	2.5A	2.0A	1.5A

Contact Resistance: 20 milliohms max.
 Dielectric Withstanding Voltage: 1000V AC/1 min.
 Insulation Resistance: 1000 Megohms min.

Physical

Housing: Nylon, UL 94V-0
 Contact: Brass
 Plating: Tin over Copper

Circuits	Order No.	Lead-free
2	22-05-1022	Yes
3	22-05-1032	
4	22-05-1042	
5	22-05-1052	
6	22-05-1062	
7	22-05-1072	
8	22-05-1082	

Circuits	Order No.	Lead-free
9	22-05-1092	Yes
10	22-05-1102	
11	22-05-1112	
12	22-05-1122	
13	22-05-1132	
14	22-05-1142	
15	22-05-1152	

2.50mm (.098") Pitch Mini-Lock™ Wire-to-Wire Crimp Terminal

50837
Male

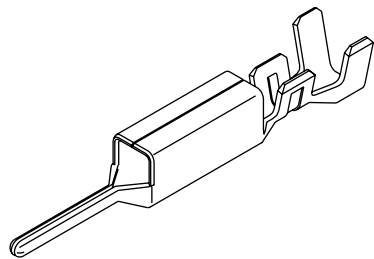

Order No.	Packaging	Lead-free
50837-8000	Reel	Yes
50837-8100	Bag	

Features and Benefits

- Locking window provides secure mating retention to housing lance

Reference Information

Product Specification: PS-51198-003
Use With: 51198
Designed In: Millimeters

Electrical

Voltage: 250V max.
Current: 3.0A max.

Physical

Contact: Phosphor Bronze
Plating: Tin
Wire Range: 22 to 28 AWG
Insulation Diameter: 1.15 to 1.80mm (.045 to .071")
Strip Length: 2.30 to 2.80mm (.091 to .110")

2.50mm (.098") Pitch Mini-Lock™ Wire-to-Wire Plug

51198
Positive Lock
Panel Mount

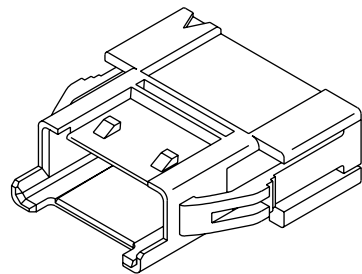

Features and Benefits

- Sizes 2 to 15 circuits
- One-piece mounting ears provide easy panel attachment and secure retention
- Guide ramp helps facilitate mating
- Housing locking tang for secure terminal retention
- Polarized for correct mating

Reference Information

Product Specification: PS-51198-003
Packaging: Bag
UL File No.: E29179
CSA File No.: LR19980
Mates With: 51103
Use With: 50837
Designed In: Millimeters

Electrical

Voltage: 250V max.
Current: 3.0A max.
Contact Resistance: 20 milliohms max.
Dielectric Withstanding Voltage: 1000V AC/1 min.
Insulation Resistance: 1000 Megohms min.

Physical

Housing: White PBT, UL 94V-0

Circuits	Order No.
2	51198-0200
3	51198-0300
4	51198-0400
5	51198-0500
6	51198-0600
7	51198-0700
8	51198-0800

Circuits	Order No.
9	51198-0900
10	51198-1000
11	51198-1100
12	51198-1200
13	51198-1300
14	51198-1400
15	51198-1500

2.50mm (.098") Pitch Mini-Lock™ Wire-to-Board Crimp Terminal

50351

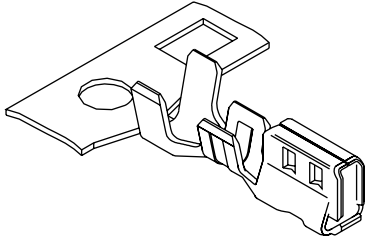

Order No.	Packaging	Lead-free
50351-8000	Reel	Yes
50351-8100	Bag	

Features and Benefits

- Four points of contact
- Housing lance provides secure terminal retention

Reference Information

Use With: 51102 and 51103
Designed In: Millimeters

Electrical

Voltage: 250V max.
Current: 3.0A max.

Physical

Contact: Phosphor Bronze
Plating: Tin
Wire Range: 22 to 28 AWG
Insulation Range: 1.15 to 1.80mm dia.
Strip Length: 2.30 to 2.80mm

2.50mm (.098") Pitch Mini-Lock™ Wire-to-Board Crimp Terminal

50752
Female

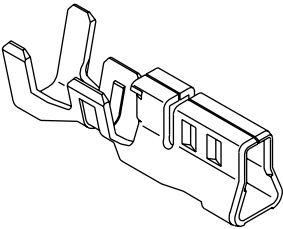

Order No.	Packaging	Lead-free
50752-8000	Reel	Yes

Features and Benefits

- Four points of contact
- Terminal design locks into housing lance

Reference Information

Mates With: 51103 and 51163
Designed In: Millimeters

Electrical

Voltage: 250V max.
Current: 3A max.

Physical

Contact: Phosphor Bronze
Plating: Tin
Wire Range: 22 to 28 AWG
Insulation Range: 1.15 to 1.80mm (.045 to .070") dia.
Strip Length: 2.00 to 2.50mm (.079 to .098")

2.50mm (.098") Pitch Mini-Lock™ Wire-to-Board Housing

51102 Friction Lock Type

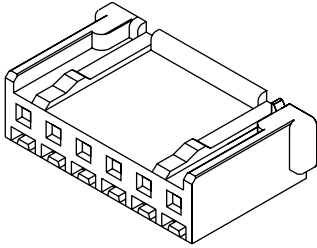

Features and Benefits

- Sizes 2 to 15 circuits
- Friction lock provides secure mating retention
- Pull tabs on top and sides enable easy extraction
- Housing lance provides secure terminal retention

Reference Information

Product Specification: Refer to Mates With items
Packaging: Bag
Mates With: 53375 and 53426
Use With: 50351
Designed In: Millimeters

Electrical

Voltage: 250V max.
Current: 3.0A max.
Contact Resistance: 20 milliohms max.
Dielectric Withstanding Voltage: 1000V AC/1 min.
Insulation Resistance: 1000 Megohms min.

Physical

Housing: White PBTP, UL 94V-0

Circuits	Order No.
2	51102-0200
3	51102-0300
4	51102-0400
5	51102-0500
6	51102-0600
7	51102-0700
8	51102-0800

Circuits	Order No.
9	51102-0900
10	51102-1000
11	51102-1100
12	51102-1200
13	51102-1300
14	51102-1400
15	51102-1500

2.50mm (.098") Pitch Mini-Lock™ Wire-to-Board Housing

51103 Positive Lock Type

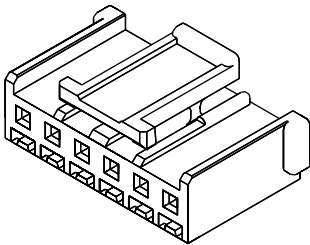

Features and Benefits

- Sizes 2 to 15 circuits
- Anti-overstress feature protects latch
- Pull tabs on top and side enable easy extraction
- Housing lance provides secure terminal retention

Reference Information

Product Specification: Refer to Mates With items
Packaging: Bag
UL File No.: E29179
Mates With: 53375, 53426, 53517 and 53608
Use With: 50351 and 50752
Designed In: Millimeters

Electrical

Voltage: 250V max.
Current: 3.0A max.
Contact Resistance: 20 milliohms max.
Dielectric Withstanding Voltage: 1000V AC/1 min.
Insulation Resistance: 1000 Megohms min.

Physical

Housing: White PBTP, UL 94V-0

Circuits	Order No.
2	51103-0200
3	51103-0300
4	51103-0400
5	51103-0500
6	51103-0600
7	51103-0700
8	51103-0800

Circuits	Order No.
9	51103-0900
10	51103-1000
11	51103-1100
12	51103-1200
13	51103-1300
14	51103-1400
15	51103-1500

2.50mm (.098") Pitch Mini-Lock™ Wire-to-Board Housing

51163
Positive Lock Type

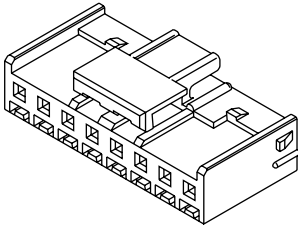

Features and Benefits

- Sizes 2 to 15 circuits
- Positive lock latch provides secure mating retention
- Anti-overstress feature protects latch
- Housing lance provides secure terminal retention

Reference Information

Product Specification: Refer to Mates With items
Packaging: Bag
Use With: 50752 and 50351 terminal and 51164 retainer
Mates With: 53375 and 53426
Designed In: Millimeters

Electrical

Voltage: 250V max.
Current: 3A max.
Contact Resistance: 20 milliohms max.
Dielectric Withstanding Voltage: 1000V AC/1 min.
Insulation Resistance: 1000 Megohms min.

Physical

Housing: White PBTP, UL 94V-0

Circuits	Order No.
2	51163-0200
3	51163-0300
4	51163-0400
5	51163-0500
6	51163-0600
7	51163-0700
8	51163-0800

Circuits	Order No.
9	51163-0900
10	51163-1000
11	51163-1100
13	51163-1300
14	51163-1400
15	51163-1500

2.50mm (.098") Pitch Mini-Lock™ Wire-to-Board Terminal Retainer

51164

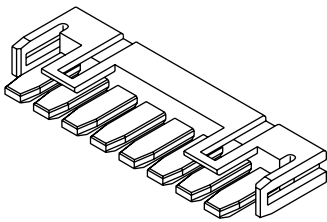

Features and Benefits

- Sizes 2 to 14 circuits
- Provides additional terminal retention and alignment

Reference Information

Product Specification: PS-51163-002
Packaging: Bag
Use With: 51163
Designed In: Millimeters

Physical

Housing: Gray PBTP, UL 94V-0

Circuits	Order No.
2	51164-0205
3	51164-0305
4	51164-0405
5	51164-0505
6	51164-0605
7	51164-0705

Circuits	Order No.
9	51164-0905
10	51164-1005
12	51164-1205
13	51164-1305
14	51164-1405

2.50mm (.098") Pitch Mini-Lock™ Wire-to-Board Header

53375
Vertical

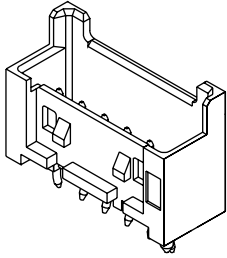

Circuits	Order No.	Lead-free
2	53375-0210	Yes
3	53375-0310	
4	53375-0410	
5	53375-0510	
6	53375-0610	
7	53375-0710	
8	53375-0810	

Circuits	Order No.	Lead-free
9	53375-0910	Yes
11	53375-1110	
12	53375-1210	
13	53375-1310	
14	53375-1410	
15	53375-1510	

Features and Benefits

- Sizes 2 to 15 circuits
- Locking ribs and holes accept either positive or friction-locking housings
- High guide walls protect terminals and facilitate mating
- Kinked PC tails provide secure PCB retention

Reference Information

Product Specification: PS-51103-005, PS-51103-007;
PS-51163-002 (with 51164 retainer)

Packaging: Bag
Mates With: 51102, 51103 and 51163
Designed In: Millimeters

Electrical

Voltage: 250V max.
Current: 3.0A max.
Contact Resistance: 20 milliohms max.
Dielectric Withstanding Voltage: 1000V AC/1 min.
Insulation Resistance: 1000 Megohms min.

Physical

Housing: Glass-filled PBTP, UL 94V-0
Contact: Phosphor Bronze
Plating: Tin

2.50mm (.098") Pitch Mini-Lock™ Wire-to-Board Header

53375
Vertical
Radial Tape

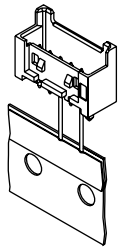

Circuits	Order No.	Lead-free
2	53375-0290	Yes
3	53375-0390	
4	53375-0490	
5	53375-0590	

Circuits	Order No.	Lead-free
6	53375-0690	Yes
7	53375-0790	
8	53375-0890	

Features and Benefits

- Sizes 2 to 8 circuits
- Radial tape enables high volume automatic placement of through hole components
- Locking ribs and holes accept either positive or friction-locking housings
- High guide walls protect terminals and facilitate mating
- Kinked PC tails provide secure PCB retention

Reference Information

Product Specification: PS-51103-005, PS-51103-007;
PS-51163-002 (with 51164 retainer)

Packaging: Radial tape
Mates With: 51102, 51103 and 51163
Designed In: Millimeters

Electrical

Voltage: 250V max.
Current: 3.0A max.
Contact Resistance: 20 milliohms max.
Dielectric Withstanding Voltage: 1000V AC/1 min.
Insulation Resistance: 1000 Megohms min.

Physical

Housing: Glass-filled PBTP, UL 94V-0
Contact: Phosphor Bronze
Plating: Tin

2.50mm (.098") Pitch Mini-Lock™ Wire-to-Board Header

53426
Right Angle

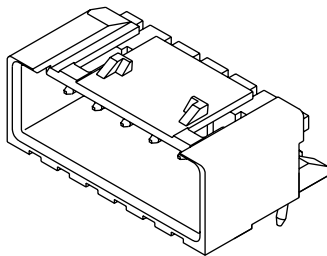

Features and Benefits

- Sizes 2 to 15 circuits
- Locking ribs and holes accept either positive or friction-locking housings
- Shrouded design protects terminals and facilitates mating
- Kinked PC tails provide secure PCB retention

Reference Information

Product Specification: PS-51102-002, PS-51103-005,
PS-51103-007; PS-51163-002 (with 51164 retainer)

Packaging: Tray
UL File No.: E29179
Mates With: 51102, 51103 and 51163
Designed In: Millimeters

Electrical

Voltage: 250V max.
Current: 3.0A max.
Contact Resistance: 20 milliohms max.
Dielectric Withstanding Voltage: 1000V AC/1 min.
Insulation Resistance: 1000 Megohms min.

Physical

Housing: Glass-filled PBTP, UL 94V-0
Contact: Phosphor Bronze
Plating: Tin

Circuits	Order No.	Lead-free
2	53426-0210	Yes
3	53426-0310	
4	53426-0410	
5	53426-0510	
6	53426-0610	
7	53426-0710	
8	53426-0810	

Circuits	Order No.	Lead-free
9	53426-0910	Yes
10	53426-1010	
11	53426-1110	
12	53426-1210	
13	53426-1310	
14	53426-1410	
15	53426-1510	

2.50mm (.098") Pitch Mini-Lock™ Wire-to-Board Header

53426
Right Angle
Radial Tape

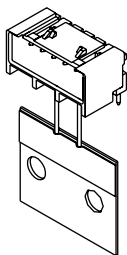

Features and Benefits

- Sizes 2 to 8 circuits
- Radial tape enables high volume automatic placement of through hole components
- Locking ribs and holes accept either positive or friction-locking housings
- Shrouded design protects terminals and facilitates mating
- Kinked PC tails provide secure PCB retention

Reference Information

Product Specification: PS-51102-002, PS-51103-005,
PS-51103-007; PS-51163-002 (with 51164 retainer)

Packaging: Radial tape
UL File No.: E29179
Mates With: 51102, 51103 and 51163
Designed In: Millimeters

Electrical

Voltage: 250V max.
Current: 3.0A max.
Contact Resistance: 20 milliohms max.
Dielectric Withstanding Voltage: 1000V AC/1 min.
Insulation Resistance: 1000 Megohms min.

Physical

Housing: Glass-filled PBTP, UL 94V-0
Contact: Phosphor Bronze
Plating: Tin

Circuits	Order No.	Lead-free
2	53426-0290	Yes
3	53426-0390	
4	53426-0490	
5	53426-0590	

Circuits	Order No.	Lead-free
6	53426-0690	Yes
7	53426-0790	
8	53426-0890	

2.50mm (.098") Pitch Mini-Lock™ Wire-to-Board Header

53517
Vertical

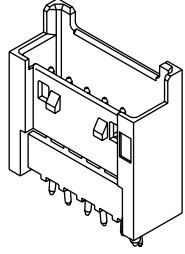

Features and Benefits

- Sizes 2 to 15 circuits
- Potting type used for sealing components in white goods applications
- Bottom ridge protects terminal signal area during potting

Reference Information

Product Specification: PS-51103-006, PS-51103-024

Packaging: Tray

UL File No.: E29179

Mates With: 51103

Designed In: Millimeters

Electrical

Voltage: 250V max.

Current: 3.0A max.

Contact Resistance: 20 milliohms max.

Dielectric Withstanding Voltage: 1000V AC/1 min.

Insulation Resistance: 1000 Megohms min.

Physical

Housing: Nylon, UL 94V-0

Contact: Phosphor Bronze





Plating: Tin

Circuits	Order No.	Lead-free
2	53517-0210	Yes
3	53517-0310	
4	53517-0410	
5	53517-0510	
6	53517-0610	
7	53517-0710	
8	53517-0810	

Circuits	Order No.	Lead-free
9	53517-0910	Yes
10	53517-1010	
11	53517-1110	
12	53517-1210	
13	53517-1310	
14	53517-1410	
15	53517-1510	

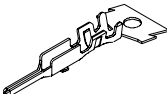
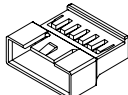
2.00 to 2.50mm (.079 to .098") Pitch PCB and Wire Connectors

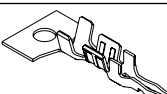
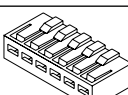
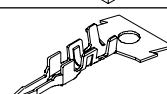
2.50mm (.098") Pitch

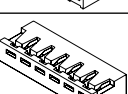
Pitch	Series		Tradename	Description
2.50mm (.098")	35053			Female Crimp Terminal
	35184			Plug
	35155			Housing
	50097		Board-In	Terminal
	51035			Housing
	35047			Terminal
	35164			Housing
	35022			Housing

C
2.00 to 2.50mm (.079 to .098") Pitch PCB and Wire Connectors

2.50mm (.098") Pitch Wire-to-Wire Terminal

35053

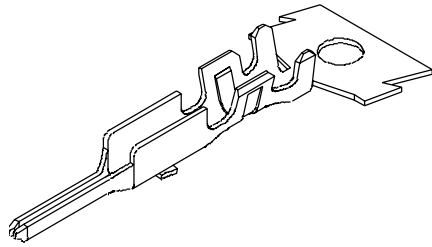

Order No.	Lead-free
35053-9002	Yes

Features and Benefits

- Rigid contact

Reference Information

Packaging: Reel
 Mates With: 5103
 Use With: 35184
 Designed In: Millimeters

Electrical

Voltage: 250V max.
 Current:

AWG	22	24	26	28
	3.0A	2.5A	2.0A	1.5A

Physical

Contact: Brass
 Plating: Tin
 Insulation Diameter: 1.90mm (.075") max.
 Wire Gauge: 22 to 28 AWG

www.molex.com/customer.html?seriesNumber=35053

2.50mm (.098") Pitch Wire-to-Wire Plug

35184

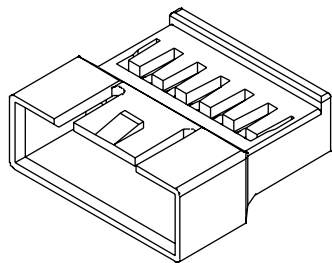

Features and Benefits

- Sizes 2 to 14 circuits
- Locking windows secure terminal to housing
- Accepts 22 to 28 AWG

Reference Information

Product Specification: PS-35184
 Packaging: Bag
 UL File No.: E29179
 CSA File No.: LR19980
 Mates With: 35155
 Use With: 35053
 Designed In: Millimeters

Electrical

Voltage: 250V max.
 Current: 3.0A max.
 Contact Resistance: 20 milliohms max.
 Dielectric Withstanding Voltage: 1000V AC/1 min.
 Insulation Resistance: 1000 Megohms min.

Physical

Housing: PA, UL 94V-0

Circuits	Order No.
2	35184-0200
3	35184-0300
4	35184-0400
5	35184-0500
6	35184-0600

Circuits	Order No.
7	35184-0700
8	35184-0800
9	35184-0900
10	35184-1000
11	35184-1100

Circuits	Order No.
12	35184-1200
14	35184-1400

2.50mm (.098") Pitch Wire-to-Wire Housing

35155
Positive Lock

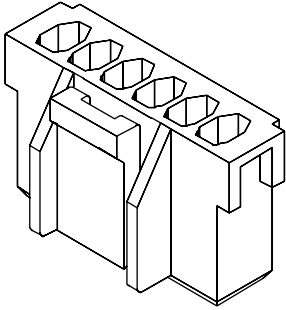

Features and Benefits

- Sizes 2 to 15 circuits
- Positive locking latch
- Polarization prevents mismatching
- Protective ribs on each side of latch

Reference Information

Product Specification: PS-35184
Packaging: Bag
UL File No.: E29179
CSA File No.: LR19980
TUV License No.: R9451371
Mates With: 35184 plug
Use With: 5103
Designed In: Millimeters

Electrical

Voltage: 250V max.
Current: 3.0A max.
Contact Resistance: 20 milliohms max.
Dielectric Withstanding Voltage: 1000V AC/1 min.
Insulation Resistance: 1000 Megohms min.

Physical

Housing: PBT, UL 94V-0

Circuits	Order No.
2	35155-0200
3	35155-0300
4	35155-0400
5	35155-0500
6	35155-0600
7	35155-0700
8	35155-0800

Circuits	Order No.
9	35155-0901
10	35155-1000
11	35155-1100
12	35155-1200
13	35155-1300
14	35155-1400
15	35155-1500

www.molex.com/customer.html?seriesNumber=35155

2.50mm (.098") Pitch Board-In Terminal

50097

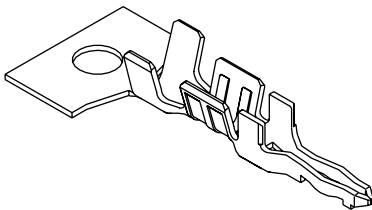

Features and Benefits

- Spring-fit style terminal provides high pressure retention to PCB
- Housing lance provides secure retention to housing and protects terminal
- PCB guide ridge helps position terminal to board

Reference Information

Use With: 51035
Designed In: Millimeters

Electrical

Voltage: 250V max.
Current: 4.0A max.

Physical

Contact: Phosphor Bronze
Plating: Tin
Wire Range: 20 to 24 AWG
0.20 to 0.50 sq. KV
0.30 to 0.50 sq. AVS
Insulation Range: 2.10mm dia. max.
Strip Length: 2.50 to 3.00mm

Order No.	Packaging	Lead-free
50097-8000	Reel	Yes
50097-8100	Bag	

2.50mm (.098") Pitch Board-In Housing

51035

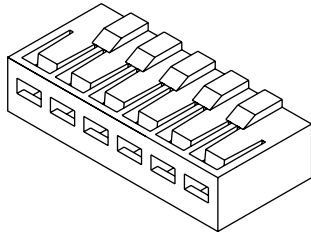

Features and Benefits

- Sizes 2 to 18 circuits
- Housing lance provides secure terminal retention and protection

Reference Information

Product Specification: PS-51035-001
 Packaging: Bag
 Use With: 50097
 Designed In: Millimeters

Electrical

Voltage: 250V max.
 Current: 4.0A max.
 Dielectric Withstanding Voltage: 1000V AC/1 min.
 Insulation Resistance: 1000 Megohms min.

Physical

Housing: Nylon, UL 94V-0

Circuits	Order No.
2	51035-0200
3	51035-0300
4	51035-0400
5	51035-0500
6	51035-0600
7	51035-0700

Circuits	Order No.
8	51035-0800
9	51035-0900
10	51035-1000
11	51035-1100
12	51035-1200
13	51035-1300

Circuits	Order No.
14	51035-1400
15	51035-1500
16	51035-1600
17	51035-1700
18	51035-1800

www.molex.com/product/board_in.html

2.50mm (.098") Pitch Board-In Terminal

35047

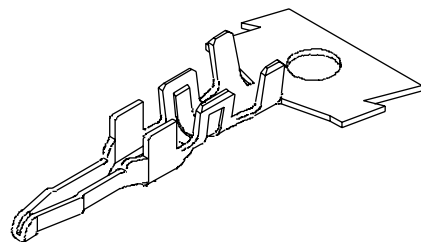

Features and Benefits

- Locking tab secures terminal to housing

Reference Information

Packaging: Reel
 Use With: 35164
 Designed In: Millimeters

Physical

Contact: Brass
 Plating: Tin
 Insulation Diameter: 1.90mm (.075") max.
 Wire Gauge: 22 to 28 AWG
 PCB Thickness: 1.60mm (.063")

Electrical

Voltage: 250V max.
 Current:

AWG	22	24	26	28
	3.0A	2.5A	1.5A	1.0A

Order No.	Lead-free
35047-9802	Yes
35047-9860	

2.50mm (.098") Pitch Board-In Housing

35164
Vertical

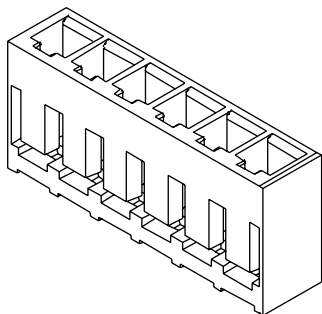

Features and Benefits

- Sizes 2 to 15 circuits
- Locking windows secure terminal to housing

Reference Information

Product Specification: PS-35164
Packaging: Bag
UL File No.: E29179
CSA File No.: LR19980
Use With: 35047
Designed In: Millimeters

Electrical

Voltage: 250V max.
Current: 3.0A max.
Contact Resistance: 5 milliohms max
Dielectric Withstanding Voltage: 1000V AC/1 min.
Insulation Resistance: 1000 Megohms min.

Physical

Housing: Nylon, UL 94V-0

Circuits	Order No.
2	35164-0200
3	35164-0300
4	35164-0400
5	35164-0500
6	35164-0600

Circuits	Order No.
7	35164-0700
8	35164-0800
9	35164-0900
10	35164-1000
11	35164-1100

Circuits	Order No.
12	35164-1200
13	35164-1300
14	35164-1400
15	35164-1500

www.molex.com/customer.html?seriesNumber=35164

2.50mm (.098") Pitch Board-In Connector Housing

35022
Right Angle

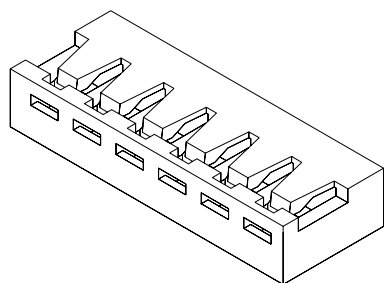

Features and Benefits

- Sizes 2 to 16 circuits
- Low profile (2.95mm)
- Terminal locking window
- Solders directly to PCB

Reference Information

Product Specification: PS-35022-003
Packaging: Bag
UL File No.: E29179
CSA File No.: LR19980
Use With: 35021 terminal
Designed In: Millimeters

Electrical

Voltage: 125V max.
Current: 3.0A max.
Contact Resistance: 5 milliohms max.
Dielectric Withstanding Voltage: 1000V AC/1 min.
Insulation Resistance: 1000 Megohms min.

Physical

Housing: Nylon, UL 94V-0

Circuits	Order No.
2	35022-0002
3	35022-0003
4	35022-0004
5	35022-0005
6	35022-0006





Circuits	Order No.
7	35022-0007
8	35022-0008
9	35022-0009
10	35022-0010
11	35022-0011

Circuits	Order No.
12	35022-0012
13	35022-0013
14	35022-0014
15	35022-0015
16	35022-0016

2.50/3.00mm (.098/.118") Pitch

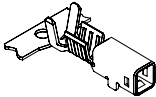
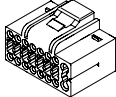

2.00 to 2.50mm (.079 to .098") Pitch PCB and Wire Connectors

Pitch	Series		Tradename	Description
2.50mm (.098")	3022-NA			Header
2.50/3.00mm (.098/.118")	50535			Female Crimp Terminal
	51128			Receptacle Housing
	53526			Header with Fuse
	91716		Appli-Mate™	Receptacle Housing
	91780			Direct Edge Card

2.50mm (.098") Pitch Wire-to-Board Header

3022-NA Single Row

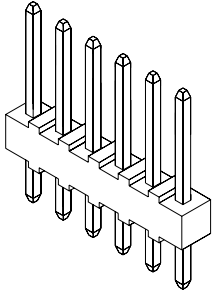

Features and Benefits

- Sizes 3 to 16 circuits

Reference Information

Product Specification: PS-99020-0088
Packaging: Bag
UL File No.: E29179
CSA File No.: LR19980
Mates With: 5051
Designed In: Millimeters

Electrical

Voltage: 250V max.
Current: 3.0A max.
Contact Resistance: 2 milliohms max.
Dielectric Withstanding Voltage: 1000V AC/1 min.
Insulation Resistance: 1000 Megohms min.

Physical

Housing: Nylon, UL 94V-0
Contact: Brass
Plating: Tin

Circuits	Order No.	Lead-free
3	22-03-1031	Yes
4	22-03-1041	
5	22-03-1051	
6	22-03-1061	
7	22-03-1071	
8	22-03-1081	
9	22-03-1091	

Circuits	Order No.	Lead-free
10	22-03-1101	Yes
11	22-03-1111	
12	22-03-1121	
13	22-03-1131	
14	22-03-1141	
15	22-03-1151	
16	22-03-1161	

www.molex.com/customer.html?seriesNumber=3022

2.50/3.00mm (.098/.118") Pitch Wire-to-Board Crimp Terminal

50535 Female

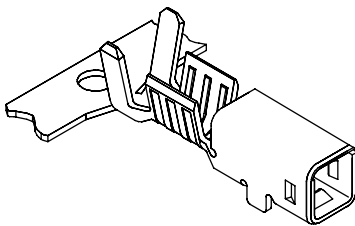

Features and Benefits

- Two points of contact
- Housing lance provides secure terminal retention
- Box design provides two points of contact and terminal protection

Reference Information

Packaging: Reel
Use With: 51128
Designed In: Millimeters

Electrical

Voltage: 250V max.
Current:

AWG	16	18	20
	10.0A	10.0A	4.0A

Physical

Contact: Brass
Plating: Tin

Order No.	Lead-free
50535-9001	Yes

2.50/3.00mm (.098/ .118") Pitch Wire-to-Board Receptacle Housing

51128

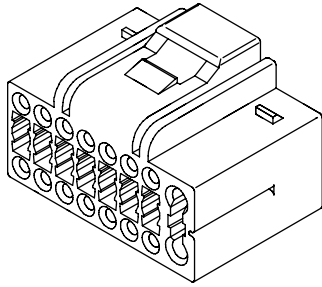

Order No.	Lead-free
51128-1601	Yes

Features and Benefits

- Size 16 circuits
- Housing lance provides extra terminal retention
- Friction lock provides secure mating

Reference Information

Product Specification: PS-51128-003
Packaging: Bag
Mates With: 53526
Use With: 50535
Designed In: Millimeters

Electrical

Voltage: 250V max.
Current: 10.0A max.
Contact Resistance: 20 milliohms max.
Dielectric Withstanding Voltage: 1000V AC/1 min.
Insulation Resistance: 1000 Megohms min.

Physical

Housing: PA, UL94

www.molex.com/customer.html?seriesNumber=51128

2.50/3.00mm (.098/ .118") Pitch Wire-to-Board Header

53526

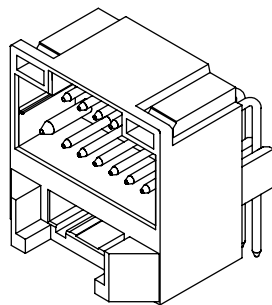

Circuits	Order No.	Lead-free
16	53526-1619	Yes

Features and Benefits

- Size 16 circuits
- Connector with power pins, signal pins and fuse
- Friction lock provides passive lock to mating connector
- High pin retention

Reference Information

Product Specification: PS-51128-003
Packaging: Bag
Mates With: 51128
Designed In: Millimeters

Electrical

Voltage: 250V max.
Current: 10.0A max.
Contact Resistance: 20 milliohms max.
Dielectric Withstanding Voltage: 1000V AC/1 min.
Insulation Resistance: 1000 Megohms min.

Physical

Housing: Nylon, UL 94V-2
Contact: Brass
Plating: Tin

2.50mm (.098") Pitch Appli-Mate™ 2.5 RAST IDT Connector System Receptacle Housing

91716

Female, Direct/Indirect

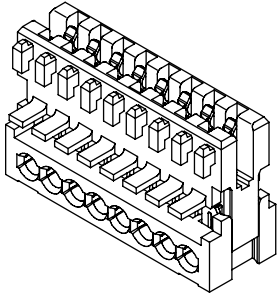

Features and Benefits

- Complies with RAST 2.5 standard specification
- Molded polarized features
- Two points of contact at interface
- Same connector will mate with male header and direct to PCB
- Suitable for use with 0.22-0.38mm cable
- Manual, semi-automatic and fully-automatic state-of-the-art terminating machines available

Reference Information

Product Specification: PS-99020-0040
Packaging: Tray
Mates With: 90860 and 90861
Designed In: Millimeters

Electrical

Voltage: 60V
Current: 2.0A
Contact Resistance: 10 milliohms max.
Dielectric Withstanding Voltage: 1000V AC
Insulation Resistance: 1000 Megohms min.

Mechanical

Mating Force: 4.00N (0.90 lb)
Unmating Force: 0.50N (0.11 lb)
Durability: 10 cycles

Physical

Housing: PBT polyester, UL 94V-0
Contact: Phosphor Bronze
Plating: Contact Area—Tin

Circuits	Order No.	Lead-free
3	91716-0001	Yes
4	91716-0501	
5	91716-1001	
6	91716-1501	
7	91716-2001	
8	91716-2501	
9	91716-3001	
10	91716-3501	
11	91716-4001	

Circuits	Order No.	Lead-free
12	91716-4501	Yes
13	91716-5001	
14	91716-5501	
15	91716-6001	
16	91716-6501	
17	91716-7001	
18	91716-7501	
19	91716-8001	
20	91716-8501	

2.50mm (.098") and 5.00mm (.197") Pitch Appli-Mate™ RAST IDT Connector System Direct Edge Card

91780

With Locking Latch

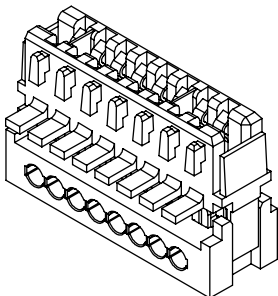

Features and Benefits

- Locks directly onto PCB, eliminating the need for a guide frame or header
- Available in 2.50 and 5.00mm pitch to allow use in high and low voltage applications
- Available in a range of circuits sizes, terminal positions, polarizing ribs and keying options.

Reference Information

Product Specification: PS-99020-0040
Packaging: Tray
Designed in: Millimeters

Electrical

Voltage: 2.50mm Pitch—32V
5.00mm Pitch—240V
Current: 2.0 A
Contact Resistance: 10 milliohms max.
Dielectric Withstanding Voltage: 1000V AC
Insulation Resistance: 1000 Megohms min.

Mechanical

Wire Pull-Out Force: 50N per circuit
Mating Force: 4N (0.90 lb)
Unmating Force: 0.5N (0.11 lb)
Durability: 10 cycles

Physical

Housing: Nylon, UL 94V-0
Contact: Copper Alloy
Plating: Contact Area—Tin
Wire Gauge: 22 to 24 AWG
PCB Thickness: 1.40mm (.056")

Circuits	Order No.	Lead-free
3	91780-0001	Yes
4	91780-0501	
5	91780-1001	
6	91780-1501	
7	91780-2001	

Circuits	Order No.	Lead-free
8	91780-2501	Yes
9	91780-3001	
10	91780-3501	
11	91780-4001	
12	91780-4501	

SL™ Modular Interconnect System

Product Overview	D-2 to D-5
Terminals	D-6 to D-7
Crimp Housings	D-7 to D-12
Insulation Displacement Connector Assemblies	D-13 to D-19
Wire-to-Wire Connectors	D-20 to D-22
Interim Clips	D-22 to D-23
Wire-to-Board Headers	
Shrouded	D-23 to D-27

C-Grid® Modular Interconnect System

Headers	
Breakaway, Dual Row	D-27 to D-30
Shrouded, Dual Row	D-30 to D-36
PCB Connectors and Receptacles	D-37 to D-40
Shunt/Jumper	D-41
Micro Shunt	D-42

C-Grid III™ Modular Interconnect System

Product Overview	D-43
Terminals	D-44
Crimp Housings	D-44
Headers	
Single Row	D-45
Dual Row	D-46 to D-47
Shrouded	D-48 to D-49
PCB Connectors	D-50

KK® Modular Interconnect System

Overview	D-51
Terminals	D-52 to D-53
Crimp Housing	D-54
IDT Connectors	D-55 to D-56
Headers	
Breakaway	D-57 to D-58
Solid	D-58 to D-61
PCB Connectors	D-62 to D-64

Custom Headers

Single Row	D-65
Dual Row	D-66

Visit www.molex.com to access more part numbers and product information, download sales drawings, product specifications, 3D models, place sample requests, and more.

C-Grid® and SL™ High Density Connectors Introduction

2.54mm (.100") Pitch PCB and Wire Connectors

D

Molex presents its 2.54mm (.100") pitch grid interconnection products. . . C-Grid, the dual row, board-to-board system and SL™, the modular, single row wire-to-board and wire-to-wire system.

The proven design of both the C-Grid and SL systems features similar material and electrical specifications. Both utilize 0.64mm (.025") square pins and selective Gold or Tin plating.

C-Grid, based on a .100" grid, is designed for dense electronic packaging. The system includes: vertical and right angle headers in breakaway, shrouded and dual-body styles; vertical and right angle receptacles; headers and receptacles for SMT applications; and a 2-circuit shunt completes the C-Grid product line.

SL is designed for high density signal applications. The system includes: low profile latching vertical and right angle headers; 5 stackable, low profile housings for male or female crimp terminals; pre-assembled, single piece pin and receptacle connector assemblies for IDT termination of discrete wire or ribbon cable and piercing crimp termination

of FFC/FPC; single and dual row latching interim clips for stacking of subassemblies to form larger connectors; panel mounts for modular wire-to-wire remote interconnections; and SL offers design flexibility and automated harness-making capabilities when combined with our tooling.

These 4 low profile, stackable housings form the basis of the single row system. Each housing accommodates either male or female terminals, IDT or crimp.

The "A" version is infinitely stackable on the X-Y matrix.

The "C" version has ribs on the front end that polarize and also prevent the housing from twisting off the mating pins during mating/disconnect.

The "D" version has back ribs that polarize, guide and maintain the connector in position in an interim clip or panel mount. It is used with both male and female terminals.

The "G" version has front ribs as well as a positive locking latch and anti-entanglement ribs to prevent wires from catching under the latch during harness-making and storage.

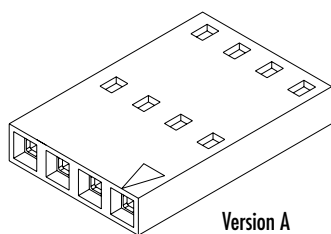

Version A

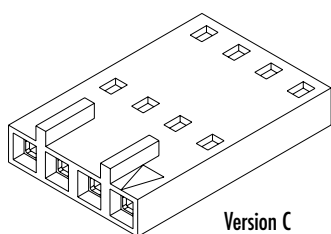

Version C

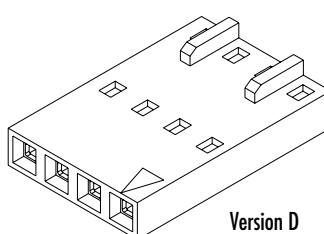

Version D

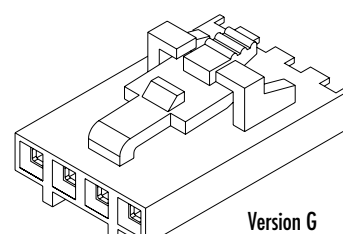

Version G

SL™ boasts pre-assembled, single piece construction of its insulation displacement-type connector assemblies. These can terminate both discrete wire or ribbon cable.

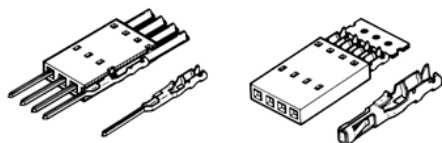

Preloaded assemblies are loaded into plastic tubes that protect the product during shipping and also allow the connector to be integrated into highly automated harness production.

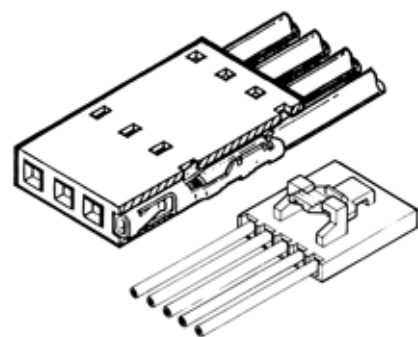

After termination the housings are locked over the terminal and the carrier strip is broken off. This automated process, with built-in diagnostic systems, assures quality products.

Originally appeared on page C-2

Shown: Wire-to-wire connection using male connectors in "D" version housings. The ribs interface to slots on the underside of the panel mount. Once loaded, the panel mount is fitted into place in the panel. Completing the connection, the female connector, "G" version, is guided through the other end of the panel mount via polarization slots. Positive latch ensures a tight lock.

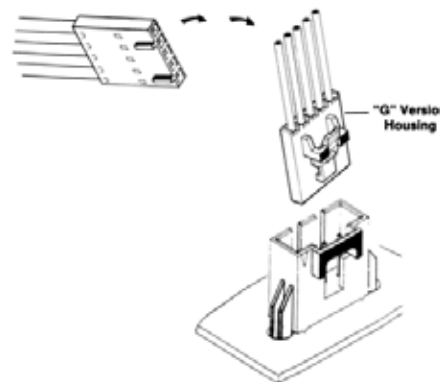
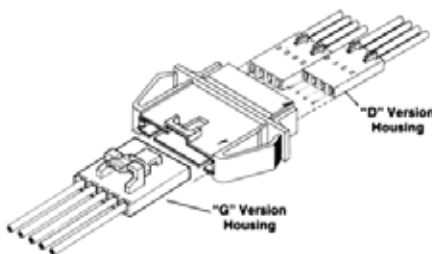

Shown: Wire-to-board connection using a shrouded header with PC board locks and a "G" version female connector. The polarizing ribs on the connector prevent it from breaking or bending the pins on the header during mating and disconnect. Note the positive latching feature.

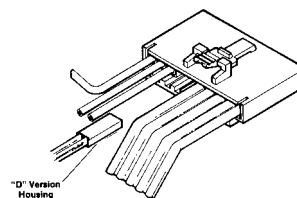
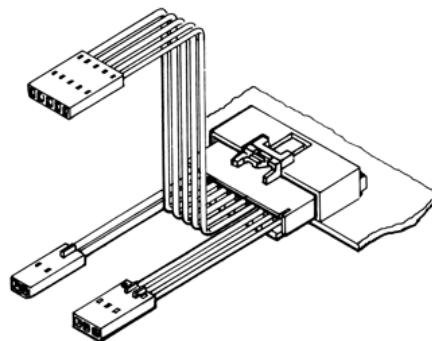

Shown: Gang loading of subassemblies in an interim clipmodule. The slots in the clip guide the "D" version housing during loading and also prevent the housing from drifting within the clip.

SL™ Modular Interconnection System

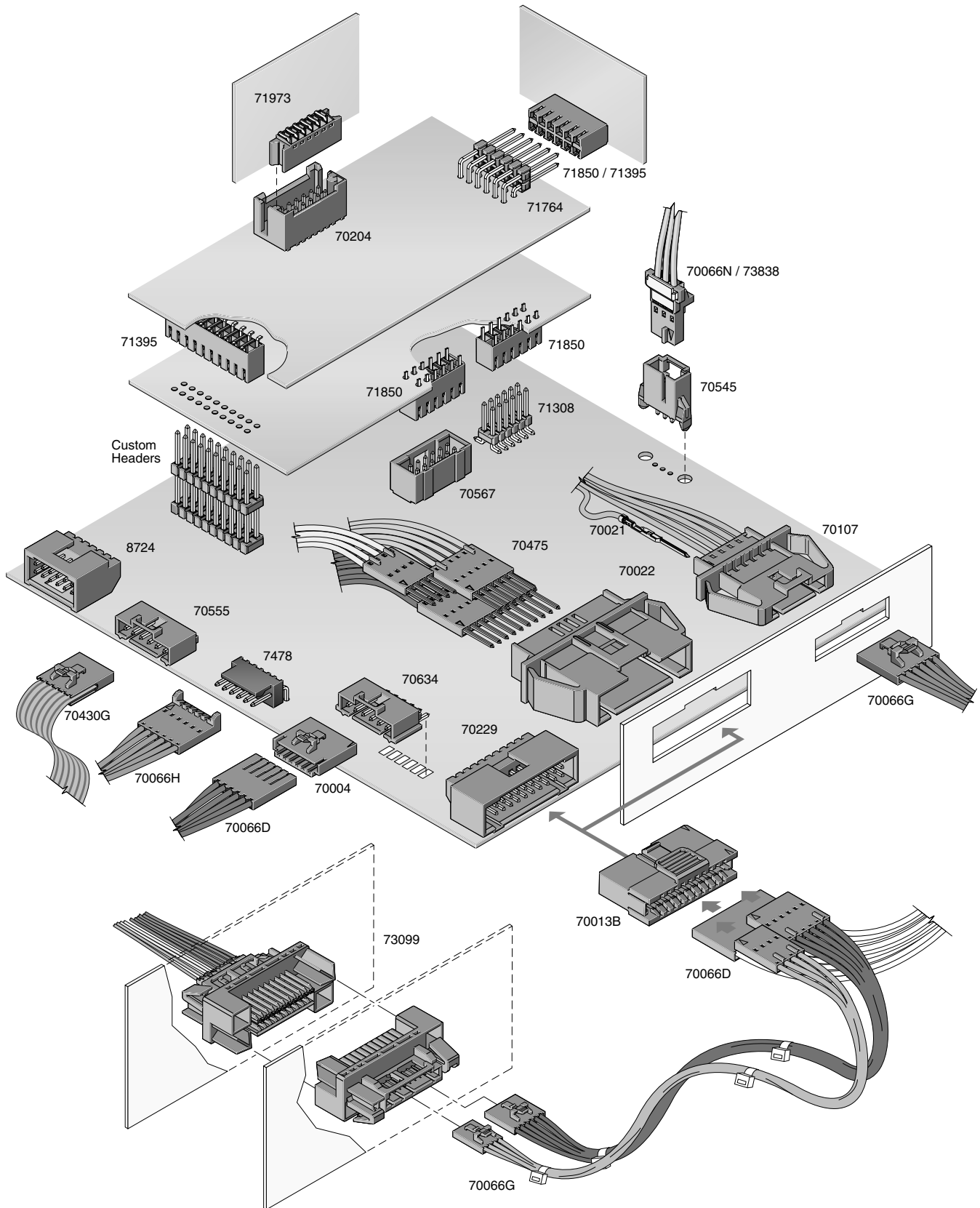

D
2.54mm (.100") Pitch PCB and Wire Connectors

SL™ Modular Interconnection System

2.54mm (.100") Pitch PCB and Wire Connectors

D

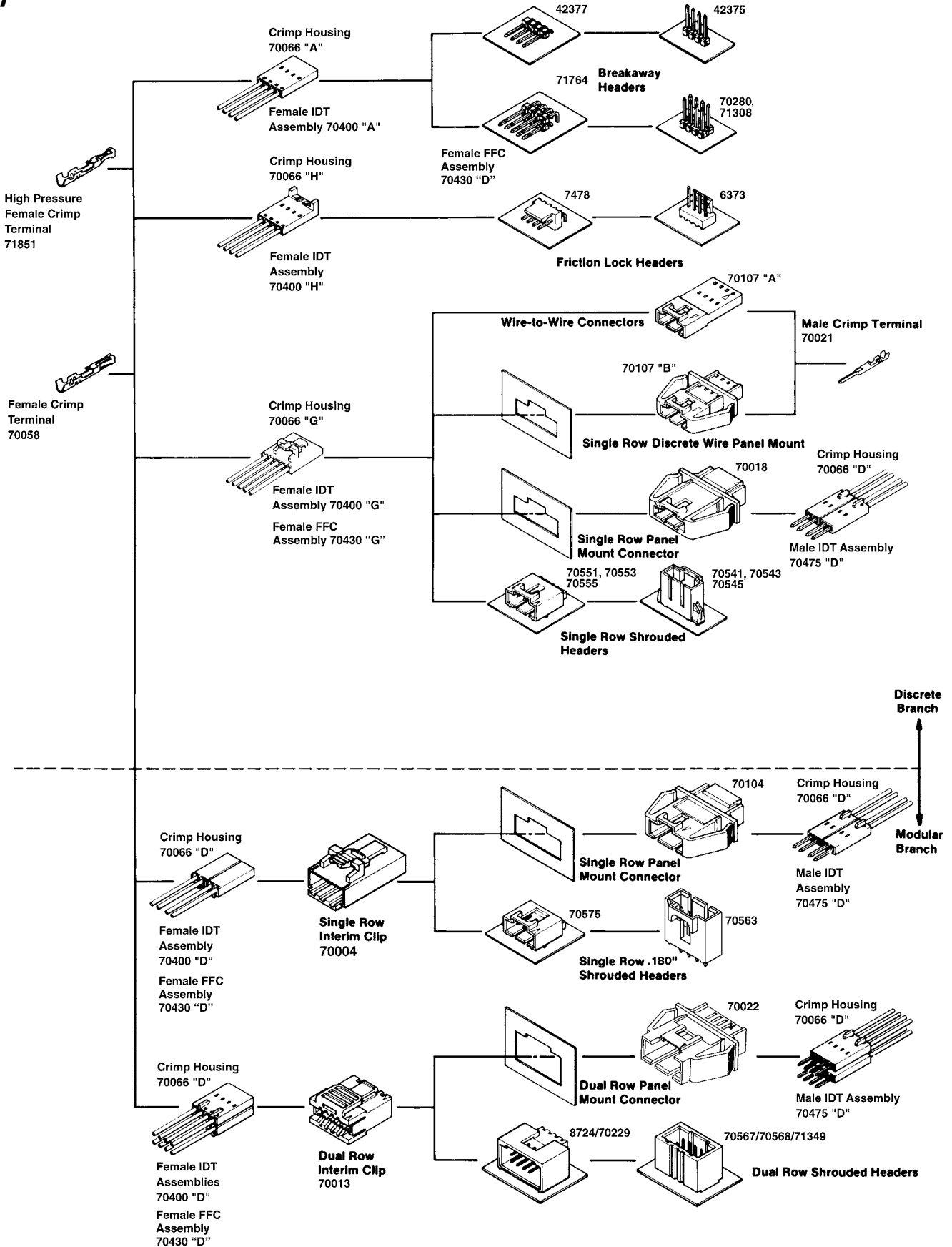



2.54mm (.100") Pitch C-Grid®/SL™ Modular Interconnect System

- Modular Interconnect System Wire-to-wire, wire-to-board and board-to-board applications
- Three Termination Methods: Crimp, IDT, FFC Cable Piercing
- Positive Latching System
- Through Hole and SMT configurations

	Description	Specifications	Materials	Circuits/Wire Gauge	Options	Series No.
--	-------------	----------------	-----------	---------------------	---------	------------

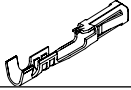
Terminals

	Female Crimp terminal	3.0A, 250V	Copper Alloy	22-30 AWG	Bag or Reel	70058 (Standard)
	Male Crimp Terminal					71851 (High Force)
						70021



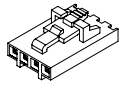
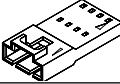
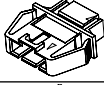
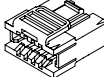

Housings

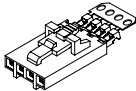
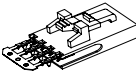
	Crimp Housing (to be used with female terminals)	3.0A, 250V	Housing: Black polyester, UL 94V-0	2-25	Single Row	70066
	Crimp Housing (to be used with Male terminals)			4-54	Dual Row	70450
	Modular Branch	3.0A, 250V	Housing: Black polyester, UL 94V-0	2-25	Single Row	70018, 70104
	Interim Clip			6-50	Dual Row	70022
				4-25	Single Row	70004
				6-50	Dual Row	70013

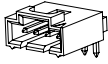

Assemblies

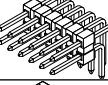
	Insulation Displacement Single Row Assembly	1.2A - 28 AWG 1.8A - 26 AWG 3.0A - 22 AWG 3.0A - 24 AWG	Housing: Black polyester, UL 94V-0	2-25	Female	70400
	FFC/FPC Single Row Assembly	2.0A, 250V	Housing: Black polyester, UL 94V-0		Male	70475
					Female	70430
					Male	70431

Headers

	Vertical Shrouded Header	3.0A, 250V	Housing: Black glass-filled PCT, UL 94V-0	2-25	Single Row	70543, 70541, 70545, 74190, 70563, 74099
	Right Angle Shrouded Header					70553, 70551, 70555, 70634, 70575
	Vertical Unshrouded Breakaway Header	3.0A, 250V	Housing: Polyester or high temperature thermal plastic, UL 94V-0	4-100	Dual Row	70280, 71308
	Right Angle Unshrouded Breakaway Header			4-80		71764, 70216
	Vertical Shrouded Header	3.0A, 250V	Housing: Polyester or high temperature thermal plastic, UL 94V-0	6-72	Dual Row	70567, 70568, 71349, 70204
	Right Angle Shrouded Header		Housing: Polyester or glass-filled nylon, UL 94V-0			8724, 70229

Receptacles

	Vertical PCB Receptacle	2.5A, 250V	Housing: High temperature thermal plastic, UL 94V-0	4-80	Dual Row	71850, 71395
	Right Angle PCB Receptacle		Housing: High temperature thermal plastic, UL 94V-0	8-72		71979, 71973

D

2.54mm (.100") Pitch PCB and Wire Connectors

2.54mm (.100") Pitch SL™ Terminal 70021 Male, Crimp

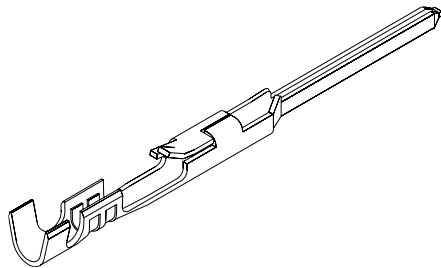

Features and Benefits

- Dual tab strain relief
- Locking tang secures terminal in housing

Reference Information

Product Specification: PS-70021
 Packaging: Reel or bag
 Mates With: 70058 and 71851 female crimp terminals,
 and 70400 and 70430 connector assemblies
 Use With: 70066D and 70107 housings
 Designed In: Inches

Electrical

Voltage: 250V
 Current: 3.0A
 Contact Resistance: 15 milliohms max.
 Insulation Resistance: 10,000 Megohms min.

Mechanical

Wire Pull-Out Force: 17.79N (4.0 lb) min.
 Durability: Tin—25 cycles; Gold—50 cycles

Physical

Contact: Copper Alloy
 Plating: See Table
 Wire Gauge: 22 to 24 and 24 to 30 AWG

Not For Use With C-Grid III™ Components

Reel				
Order No.	Plating	Wire Range (AWG) Stranded	Insulation Maximum Outside Diameter	Lead-free
16-02-0116	1	22-24	1.63 (.064)	Yes
16-02-0078		24-30	1.52 (.060)	
16-02-0081	2	22-24	1.63 (.064)	
16-02-0077		24-30	1.52 (.060)	
16-02-0107	3	22-24	1.63 (.064)	
16-02-0105		24-30	1.52 (.060)	

Bag				
Order No.	Plating	Wire Range (AWG) Stranded	Insulation Maximum Outside Diameter	Lead-free
16-02-0117	1	22-24	1.63 (.064)	Yes
16-02-0110		24-30	1.52 (.060)	
16-02-0115	2	22-24	1.63 (.064)	
16-02-0109		24-30	1.52 (.060)	
16-02-0114	3	22-24	1.63 (.064)	
16-02-0108		24-30	1.52 (.060)	

Plating No. 1: 30µ" min. Gold in select area over 50µ" min. Nickel overall with 75µ" Tin in select area
 Plating No. 2: 15µ" min. Gold in select area over 50µ" min. Nickel overall with 75µ" Tin in select area
 Plating No. 3: 150µ" Tin over 50µ" Nickel overall
 Each reel contains 20,000 terminals

2.54mm (.100") Pitch SL™ Terminal 70058 Female Box, Crimp

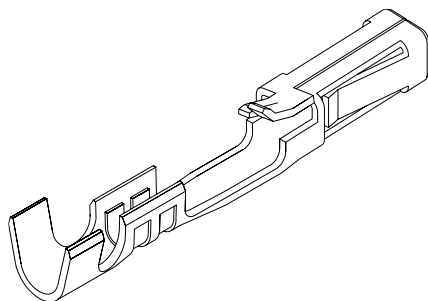

Features and Benefits

- Dual beam, fully-enclosed box contact
- Dual tab strain relief
- Locking tang secures terminal in housing

Reference Information

Product Specification: PS-70058
 Packaging: Reel or bag
 Mates With: 70021 male crimp terminals and
 0.64mm (.025") square pins
 Use With: All 70066 and 70450 housings
 Designed In: Inches

Electrical

Voltage 250V
 Current: 3.0A
 Contact Resistance: 15 milliohms max.
 Insulation Resistance: 10,000 Megohms min.

Mechanical

Contact Retention to Housing: 17.79N (4.0 lb) min.
 Wire Pull-Out Force: 17.79N (4.0 lb) min.
 Mating Force: 2.22N (.50 lb) max.
 Unmating Force: 0.28N (.06 lb) min.
 Normal Force: 0.98N (.22 lb) min.
 Durability: Tin—25 cycles; Gold—50 cycles

Physical

Contact: Copper Alloy
 Plating: See Table
 Wire Gauge: 22 to 24 and 24 to 30 AWG

Not For Use With C-Grid III™ Components

Reel				
Order No.	Plating	Wire Range (AWG) Stranded	Insulation Maximum Outside Diameter	Lead-free
16-02-0088	1	22-24	1.63 (.064)	Yes
16-02-0083		24-30	1.52 (.060)	
16-02-0087	2	22-24	1.63 (.064)	
16-02-0082		24-30	1.52 (.060)	
16-02-0086	3	22-24	1.63 (.064)	
16-02-0069		24-30	1.52 (.060)	

Bag				
Order No.	Plating	Wire Range (AWG) Stranded	Insulation Maximum Outside Diameter	Lead-free
16-02-0104	1	22-24	1.63 (.064)	Yes
16-02-0098		24-30	1.52 (.060)	
16-02-0103	2	22-24	1.63 (.064)	
16-02-0097		24-30	1.52 (.060)	
16-02-0102	3	22-24	1.63 (.064)	
16-02-0096		24-30	1.52 (.060)	

Plating No. 1: 30µ" min. Gold in select area over 50µ" min. Nickel overall with 75µ" Tin in select area
 Plating No. 2: 15µ" min. Gold in select area over 50µ" min. Nickel overall with 75µ" Tin in select area
 Plating No. 3: 150µ" Tin over 50µ" Nickel overall
 Each reel contains 20,000 terminals

2.54mm (.100") Pitch SL™ Terminal

71851 Female, High Force Crimp

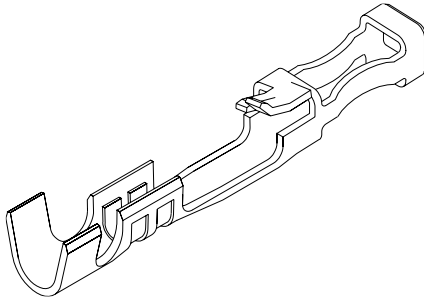

Features and Benefits

- Dual beam, fully-enclosed box contact
- Higher mating force than standard crimp terminal
- For use with low current/high vibration applications in small circuit sizes
- Dual tab strain relief
- Locking tang secures terminal in housing

Reference Information

Product Specification: PS-71851
 Packaging: Reel or bag
 Mates With: 70021 male crimp terminals,
 70431 and 70475 male connector assemblies
 and 0.64mm (.025") square pins
 Use With: 70066 and 70450 housings
 Designed In: Inches

Electrical

Voltage: 250V
 Current: 3.0A
 Contact Resistance: 15 milliohms max.
 Insulation Resistance: 10,000 Megohms min.

Mechanical

Contact Retention to Housing: 17.79N (4.0 lb) min.
 Wire Pull-Out Force: 17.79N (4.0 lb) min.
 Mating Force: Tin—12.14N (2.73 lb) max.
 Gold—5.07N (1.14 lb)
 Unmating Force: Tin—3.60N (.81 lb) min.
 Gold—2.36N (.53 lb)
 Durability: Tin—25 cycles; Gold—50 cycles

Physical

Contact: Copper Alloy
 Plating: See Table
 Wire Gauge: 22 to 24 and 24 to 30 AWG

Not For Use With C-Grid III™ Components

Reel				
Order No.	Plating	Wire Range (AWG) Stranded	Insulation Maximum Outside Diameter	Lead-free
16-02-1111	1	22-24	1.63 (.064)	Yes
16-02-1113		24-30	1.52 (.060)	
16-02-1124	2	22-24	1.63 (.064)	
16-02-0119		24-30	1.52 (.060)	
16-02-1110	3	22-24	1.63 (.064)	
16-02-1112		24-30	1.52 (.060)	

Bag				
Order No.	Plating	Wire Range (AWG) Stranded	Insulation Maximum Outside Diameter	Lead-free
16-02-1115	1	22-24	1.63 (.064)	Yes
16-02-1117		24-30	1.52 (.060)	
16-02-1125	2	22-24	1.63 (.064)	
16-02-1109		24-30	1.52 (.060)	
16-02-1114	3	22-24	1.63 (.064)	
16-02-1116		24-30	1.52 (.060)	

Plating No. 1: 30µm min. Gold in select area over 50µm min. Nickel overall with 75µm Tin
 Plating No. 2: 15µm min. Gold in select area over 50µm min. Nickel overall with 75µm min. Tin in select area
 Plating No. 3: 150µm Tin over 50µm Nickel overall
 Each reel contains 20,000 terminals

2.54mm (.100") Pitch SL™ Crimp Housing

70066 Single Row Version A, Nonpolarized

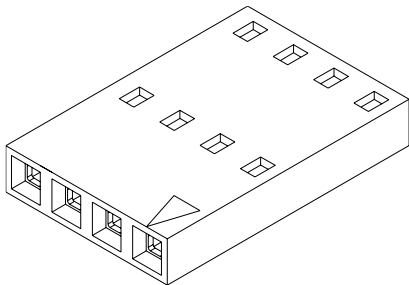

Features and Benefits

- Sizes 2 to 25 circuits
- End-to-end and side-to-side stackable for single or dual row connections to a 2.54mm (.100") pitch grid pin field

Reference Information

Product Specification: PS-70400
 Packaging: Bag
 UL File No.: E29179
 CSA File No.: LR19980
 Mates With: 2.54mm (.100") pitch, single or dual row
 headers (C-Grid®, SL, KK®)
 Use With: 70058 and 71851 crimp terminals
 Designed In: Inches

Physical

Housing: Black polyester, UL 94V-0

Delivered on a carrier with 20 pieces per strip.

Actual Size  **Universal Polarizing Pin 40713-1**
 Order No. 15-04-0292

Not For Use With C-Grid III™ Components

Circuits	Order No.
2	50-57-9002
3	50-57-9003
4	50-57-9004
5	50-57-9005
6	50-57-9006
7	50-57-9007
8	50-57-9008
9	50-57-9009

Circuits	Order No.
10	50-57-9010
11	50-57-9011
12	50-57-9012
13	50-57-9013
14	50-57-9014
15	50-57-9015
16	50-57-9016
17	50-57-9017

Circuits	Order No.
18	50-57-9018
19	50-57-9019
20	50-57-9020
21	50-57-9021
22	50-57-9022
23	50-57-9023
24	50-57-9024
25	50-57-9025

2.54mm (.100") Pitch SL™ Crimp Housing

70066
Single Row
Version C, Front Ribs

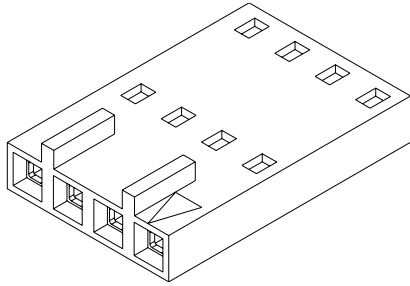

Not For Use With C-Grid III™ Components

Circuits	Order No.
2	50-57-9202
3	50-57-9203
4	50-57-9204
5	50-57-9205
6	50-57-9206
7	50-57-9207
8	50-57-9208
9	50-57-9209

Features and Benefits

- Sizes 2 to 25 circuits
- Front ribs prevent contact damage when unmating the connector from a header; the housing cannot be twisted off pins
- Front ribs provide 180° polarization

Reference Information

Product Specification: PS-70400
 Packaging: Bag
 UL File No.: E29179
 CSA File No.: LR19980
 Mates With: 2.54mm (.100") pitch SL headers
 Use With: 70058 and 71851 crimp terminals
 Designed In: Inches

Physical

Housing: Black polyester, UL 94V-0

Delivered on a carrier with 20 pieces per strip.

Actual Size  **Universal Polarizing Pin**
 40713-1
 Order No. 15-04-0292

2.54mm (.100") Pitch SL™ Crimp Housing

70066
Single Row
Version D, Back Ribs

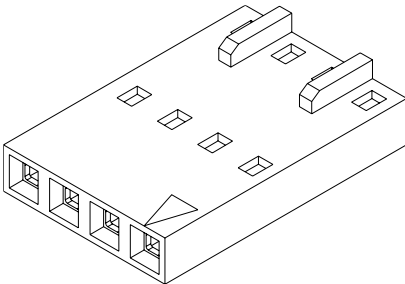

Not For Use With C-Grid III™ Components

Circuits	Order No.
2	50-57-9302
3	50-57-9303
4	50-57-9304
5	50-57-9305
6	50-57-9306
7	50-57-9307
8	50-57-9308
9	50-57-9309

Features and Benefits

- Sizes 2 to 25 circuits
- Designed for use with interim clips and panel mount connectors to form a larger single mating connector
- Back ribs maintain position of connector housing in interim clip and panel mount, and allow for end-to-end or side-to-side stacking in interim clips and panel mount connectors

Reference Information

Product Specification: PS-70400
 Packaging: Bag
 UL File No.: E29179
 CSA File No.: LR19980
 Accessories: Interim clips 70004 and 70013 to form female connector assembly; panel mount connectors 70018, 70022 and 70104 to form a male pin assembly
 Use With: 70021, 70058 and 71851 crimp terminals
 Designed In: Inches

Physical

Housing: Black polyester, UL 94V-0

Delivered on a carrier with 20 pieces per strip.

Actual Size  **Universal Polarizing Pin**
 40713-1
 Order No. 15-04-0292

Circuits	Order No.
10	50-57-9310
11	50-57-9311
12	50-57-9312
13	50-57-9313
14	50-57-9314
15	50-57-9315
16	50-57-9316
17	50-57-9317

Circuits	Order No.
18	50-57-9318
19	50-57-9319
20	50-57-9320
21	50-57-9321
22	50-57-9322
23	50-57-9323
24	50-57-9324
25	50-57-9325

2.54mm (.100") Pitch SL™ Crimp Housing

70066
Single Row
Version G, Positive Latch

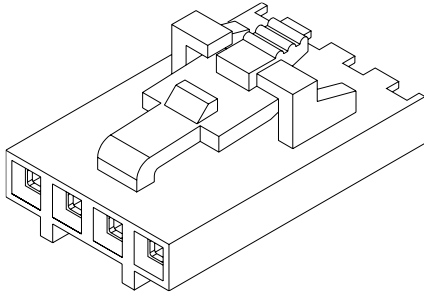

Features and Benefits

- Sizes 2 to 25 circuits
- Positive latch secures housing to locking crown of mating header or panel mount
- Anti-entanglement/overstress ribs prevent discrete wires from catching under latch during harness manufacturing and storage
- Front ribs prevent contact damage when unmating the connector from a header; the housing cannot be twisted off pins

Reference Information

Product Specification: PS-70400
 Packaging: Bag
 UL File No.: E29179
 CSA File No.: LR19980
 Mates With: 70018, 70107A/B, 70541, 70543, 70545, 70551, 70553, 70555, 70634 and 74099
 Use With: 70058 and 71851 crimp terminals
 Designed In: Inches

Physical

Housing: Black polyester, UL 94V-0

Delivered on a carrier with 20 pieces per strip.

Actual Size		Universal Polarizing Pin 40713-1
		Order No. 15-04-0292

Not For Use With C-Grid III™ Components

Circuits	Order No.
2	50-57-9402
3	50-57-9403
4	50-57-9404
5	50-57-9405
6	50-57-9406
7	50-57-9407
8	50-57-9408
9	50-57-9409

Circuits	Order No.
10	50-57-9410
11	50-57-9411
12	50-57-9412
13	50-57-9413
14	50-57-9414
15	50-57-9415
16	50-57-9416
17	50-57-9417

Circuits	Order No.
18	50-57-9418
19	50-57-9419
20	50-57-9420
21	50-57-9421
22	50-57-9422
23	50-57-9423
24	50-57-9424
25	50-57-9425

2.54mm (.100") Pitch SL™ Crimp Housing

70066
Single Row
Version H

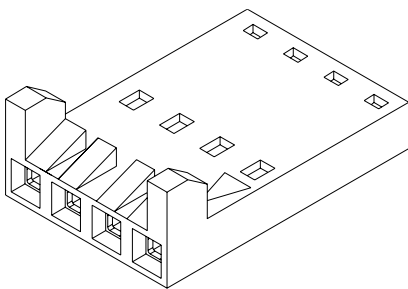

Features and Benefits

- Sizes 2 to 25 circuits
- Stackable end-to-end
- Polarized latching ribs mate with Molex KK® series .100" pitch friction lock headers

Reference Information

Product Specification: PS-70400
 Packaging: Bag
 UL File No.: E29179
 CSA File No.: LR19980
 Mates With: 6373 and 7478
 Use With: 70058 and 71851 crimp terminals
 Designed In: Inches

Physical

Housing: Black polyester, UL 94V-0

Delivered on a carrier with 20 pieces per strip.

Actual Size		Universal Polarizing Pin 40713-1
		Order No. 15-04-0292

Not For Use With C-Grid III™ Components

Circuits	Order No.
2	50-57-9502
3	50-57-9503
4	50-57-9504
5	50-57-9505
6	50-57-9506
7	50-57-9507
8	50-57-9508
9	50-57-9509

Circuits	Order No.
10	50-57-9510
11	50-57-9511
12	50-57-9512
13	50-57-9513
14	50-57-9514
15	50-57-9515
16	50-57-9516
17	50-57-9517

Circuits	Order No.
18	50-57-9518
19	50-57-9519
20	50-57-9520
21	50-57-9521
22	50-57-9522
23	50-57-9523
24	50-57-9524
25	50-57-9525

2.54mm (.100") Pitch

SL™ Crimp Housing

70066/73838

**Single Row
Version N, TPA
with Positive Latch**

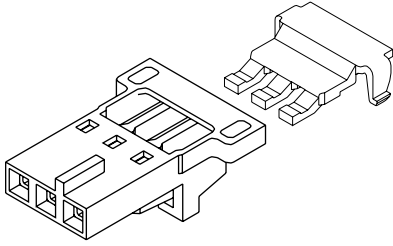

Circuits	70066 Version N TPA Crimp Housing	73838 TPA
	Order No.	Order No.
2	50-57-9702	73838-0002
3	50-57-9703	73838-0003
4	50-57-9704	73838-0004
5	50-57-9705	73838-0005
6	50-57-9706	73838-0006
7	50-57-9707	73838-0007
8	50-57-9708	73838-0008

Features and Benefits

- Optimizes terminal-to-housing retention
- Virtually eliminates terminal backout when TPA is locked into place
- Upon seating TPA, audible click denotes system activation
- White/black color contrast provides easy identification of TPA system
- Positive locking latch secures housing to mating connector
- Anti-entanglement/overstress ribs prevent discrete wires from catching under latch during harness manufacturing and storage

Reference Information

Product Specification: PS-73838, PS-70400

Packaging: Bag

UL File No.: E29179

CSA File No.: LR19980

Mates with: 70018, 70107A/B, 70541, 70543, 70545, 70551, 70553, 70555, 70634 and 74099

Use with: 73838 TPA and 70058 or 71851 crimp terminals

Designed In: Inches

Physical

Housing: Black polyester, UL 94V-0

TPA: White polyester, UL 94V-0

2.54mm (.100") Pitch

SL™ Crimp Housing

70450

**Dual Row
Version A, Nonpolarized**

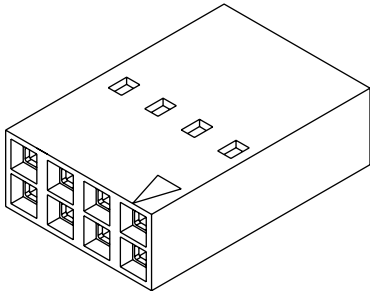

Features and Benefits

- Sizes 4 to 54 circuits
- End-to-end and side-to-side stackable for dual row connections to a 2.54mm (.100") pitch grid pin field

Reference Information

Product Specification: PS-70400

Packaging: Bag

UL File No.: E29179

CSA File No.: LR19980

Mates With: 8724, 70229, 70280, 70287, 70567, 70568, 71308 and 71349 Molex dual row headers

Use With: 70058 and 71851 crimp terminals

Designed In: Inches

Physical

Housing: Black polyester, UL 94V-0

Delivered on a carrier with 20 pieces per strip.

Actual Size  Universal Polarizing Pin
40713-1
Order No. 15-04-0292

Not For Use With C-Grid III™ Components

Circuits	Order No.
4	22-55-2041
6	22-55-2061
8	22-55-2081
10	22-55-2101
12	22-55-2121
14	22-55-2141
16	22-55-2161
18	22-55-2181
20	22-55-2201

Circuits	Order No.
22	22-55-2221
24	22-55-2241
26	22-55-2261
28	22-55-2281
30	22-55-2301
32	22-55-2321
34	22-55-2341
36	22-55-2361
38	22-55-2381

Circuits	Order No.
40	22-55-2401
42	22-55-2421
44	22-55-2441
46	22-55-2461
48	22-55-2481
50	22-55-2501
52	22-55-2521
54	22-55-2541

2.54mm (.100") Pitch SL™ Crimp Housing

70450
Dual Row
Version B, Polarized

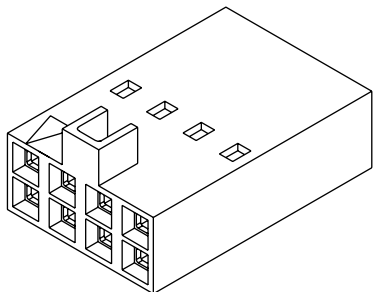

Not For Use With C-Grid III™ Components

Circuits	Order No.
4	22-55-2042
6	22-55-2062
8	22-55-2082
10	22-55-2102
12	22-55-2122
14	22-55-2142
16	22-55-2162
18	22-55-2182

Features and Benefits

- Sizes 4 to 50 circuits
- Polarized to mate with dual row, low profile shrouded headers

Reference Information

Product Specification: PS-70400
Packaging: Bag
UL File No.: E29179
CSA File No.: LR19980
Mates With: 70246, 70247, 87256 and 87257
Use With: 70058 and 71851 crimp terminals
Designed In: Inches

Physical

Housing: Black polyester, UL 94V-0

Delivered on a carrier with 20 pieces per strip.

Actual Size		Universal Polarizing Pin
		40713-1
		Order No. 15-04-0292

D

2.54mm (.100") Pitch PCB and Wire Connectors

2.54mm (.100") Pitch SL™ Crimp Housing

70450
Dual Row
Version C, Back Ribs

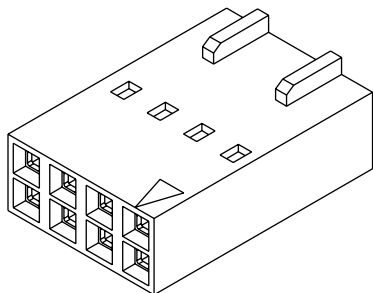

Not For Use With C-Grid III™ Components

Circuits	Order No.
4	22-55-2043
6	22-55-2063
8	22-55-2083
10	22-55-2103
12	22-55-2123
14	22-55-2143
16	22-55-2163
18	22-55-2183

Features and Benefits

- Sizes 4 to 50 circuits
- Designed to be used within 70013 dual row interim clip as a female connector assembly or 70022 dual row panel mount as a male pin assembly
- End-to-end stackable
- Back ribs maintain position of connector housings in interim clip and panel mount

Reference Information

Product Specification: PS-70400
Packaging: Bag
UL File No.: E29179
CSA File No.: LR19980
Accessories: 70013 and 70022
Use With: 70021, 70058 and 71851 crimp terminals
Designed In: Inches

Physical

Housing: Black polyester, UL 94V-0

Delivered on a carrier with 20 pieces per strip.

Actual Size		Universal Polarizing Pin
		40713-1
		Order No. 15-04-0292

2.54mm (.100") Pitch SL™ Crimp Housing 70450 Dual Row Version F

Features and Benefits

- Sizes 6 to 54 circuits
- Front guide ribs provide 180° polarization to mating connector

Reference Information

Product Specification: PS-70400
 Packaging: Bag
 UL File No.: E29179
 CSA File No.: LR19980
 Mates With: 8724, 70229, 70567, 70568 and 71349
 Use With: 70058 and 71851 crimp terminals
 Designed In: Inches

Physical

Housing: Black polyester, UL 94V-0

Delivered on a carrier with 20 pieces per strip.

Actual Size  Universal Polarizing Pin
 40713-1
 Order No. 15-04-0292

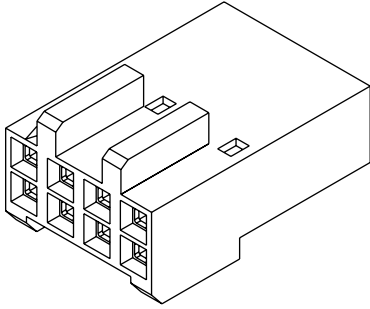

D 2.54mm (.100") Pitch PCB and Wire Connectors

Not For Use With C-Grid III™ Components

Circuits	Order No.
6	22-56-6067
8	22-56-6087
10	22-56-6107
12	22-56-6127
14	22-56-6147
16	22-56-6167
18	22-56-6187
20	22-56-6207
22	22-56-6227

Circuits	Order No.
24	22-56-6247
26	22-56-6267
28	22-56-6287
30	22-56-6307
32	22-56-6327
34	22-56-6347
36	22-56-6367
38	22-56-6387
40	22-56-6407

Circuits	Order No.
42	22-56-6427
44	22-56-6447
46	22-56-6467
48	22-56-6487
50	22-56-6507
52	22-56-6527
54	22-56-6547

2.54mm (.100") Pitch SL™

Specifications for Female Insulation Displacement Connector Assembly

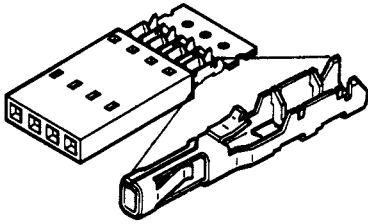

Five styles of single row IDT receptacle assemblies are available in 2 through 25 circuits. The female IDT terminal features a fully enclosed "box" design with dual beams to provide 2 points of contact.

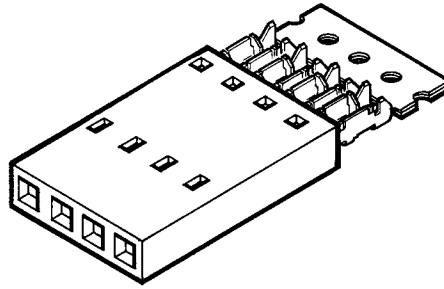

Stamped female terminals are preloaded into first window of housing for presentation of assemblies to application tooling. The carrier is color coded to identify the plating option, and the terminal is stamped with a letter code to distinguish wire gauge of the IDT slot.

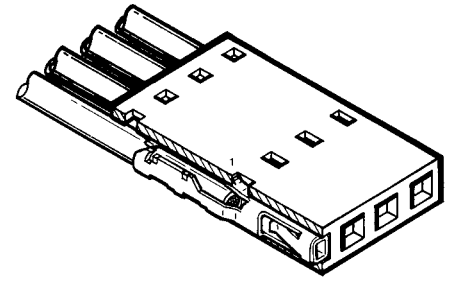

Cut away view of the IDT assembly in a loaded position. Locking tangs secure terminals in the second window.

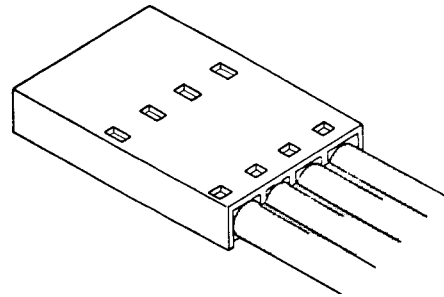

After the cable/wires are terminated, terminals are fully inserted into the housing and locked into the second window. The carrier strip is then broken off. As a result of this automated termination*, the terminals are consistently locked into the housing without damage.

* See Application Tooling section

D

2.54mm (.100") Pitch PCB and Wire Connectors

Wire and Cable Options

Recommended Molex Cable Engineering No. to use with 70400 series connectors:

Accepts round conductor flat cable from 24 to 28 AWG, with .053" max. outside insulation diameter 7234, 7307, 7560, 7767, 8867, 8996, 8997, 24241, 24327, 24369 and 24389.

Discrete Wire
(Series 70066)

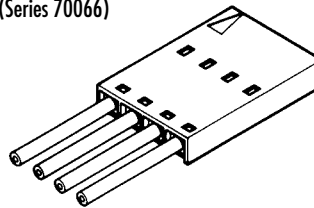

Flat Flex Cable
(Series 70430)

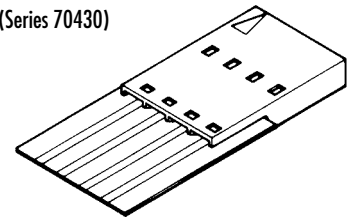

Notch Specification for Ribbon Cable

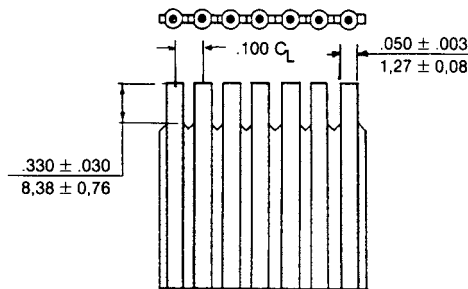

Ribbon Cable
(Series 70400)

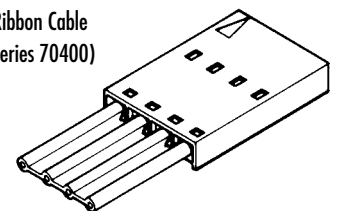

2.54mm (.100") Pitch SL™ Insulation Displacement Connector Assembly

70400

**Female, Single Row
Version A, Nonpolarized**

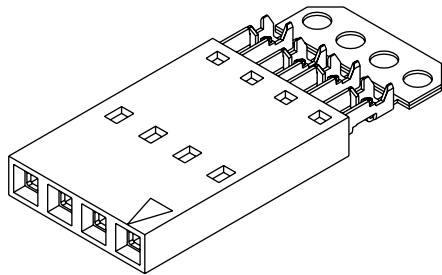

Features and Benefits

- Sizes 2 to 25 circuits
- Preloaded, single piece construction allows for fully automated termination
- Packaged in plastic tubes to allow for automated manufacturing and to minimize product handling
- End-to-end and/or side-to-side stackable for single or dual row connections to a 2.54mm (.100") pitch grid pin field

Reference Information

Product Specification: PS-70040
 Packaging: Tube
 UL File No.: E29179
 CSA File No.: LR19980
 Mates With: 2.54mm (.100") pitch, single or dual row C-Grid®, SL or KK® headers
 Use With Molex Cable: 7234, 7307, 7560, 7767, 8867, 8996, 8997, 24241, 24327, 24369 and 24389
 Designed In: Inches

Electrical

Voltage: 250V
 Current: 1.2A—28 AWG; 1.8A—26 AWG
 3.0A—24 AWG; 3.0A—22 AWG

Electrical (continued)

Contact Resistance: 15 milliohms max.
 Dielectric Withstanding Voltage: 1500V
 Insulation Resistance: 10,000 Megohms min.

Mechanical

Contact Retension to Housing: 17.79N (4 lb) min.
 Mating Force: Tin—4.15N (.93 lb) per circuit;
 Gold—3.08N (.70 lb) per circuit
 Unmating Force: Tin—2.47N (.55 lb) per circuit;
 Gold—.65N (.15 lb) per circuit
 Durability: Tin—25 cycles; Gold—50 cycles

Physical

Housing: Black polyester, UL 94V-0
 Contact: Copper Alloy
 Plating: See Table
 Insulation and Wire Gauge Range: .053" max. with 22 to 28 AWG stranded discrete wire or flat ribbon cable

Delivered on a carrier with 20 pieces per strip.

Actual Size  **Universal Polarizing Pin**
40713-1
 Order No. 15-04-0292

Not For Use With C-Grid III™ Components

Wire Accommodation (AWG)	Order No.			Lead-free
	150µm Tin	15µm Gold	30µm Gold	
28	14-60-0XX5	14-56-2XX5	14-56-3XX2	Yes
26	14-60-0XX3	14-56-2XX3	14-56-2XX9	
24	14-60-0XX1	14-56-2XX1	14-56-2XX7	
22	14-60-6XX9	14-56-7XX4	14-56-7XX9	

Replace XX with no. of circuits, 02-25

Plating Code (Stripe on Carrier Strip)	
Plating	Color
Tin	None
15µm Gold	Yellow
30µm Gold	Red

Wire Gauge Chart	
Code Stamped on Terminals	Wire Gauge (AWG)
A	24
B	26
C	28
D	22

Note: 2 circuit assemblies supplied as grouped pairs

2.54mm (.100") Pitch SL™ Insulation Displacement Connector Assembly

70400

**Female, Single Row
Version C, Front Ribs**

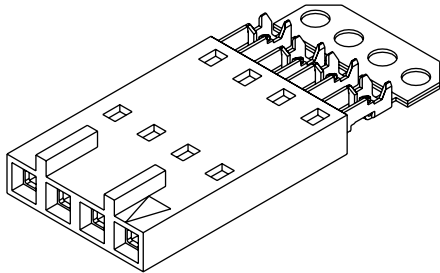

Features and Benefits

- Sizes 2 to 25 circuits
- Preloaded, single piece construction allows for fully automated termination
- Packaged in plastic tubes to allow for automated manufacturing and to minimize product handling
- Front polarizing ribs prevent pin damage during disconnect; housing cannot be twisted off pins

Reference Information

Product Specification: PS- 70400
 Packaging: Tube
 UL File No.: E29179
 CSA File No.: LR19980
 Mates With: 2.54mm (.100") pitch SL headers
 Use With Molex Cable: 7234, 7307, 7560, 7767, 8867, 8896, 8897, 24241, 24327, 24369 and 24389
 Designed In: Inches

Electrical

Voltage: 250V
 Current: 1.2A—28 AWG; 1.8A—26 AWG
 3.0A—24 AWG; 3.0A—22 AWG

Electrical (continued)

Contact Resistance: 15 milliohms max.
 Dielectric Withstanding Voltage: 1500V
 Insulation Resistance: 10,000 Megohms min.

Mechanical

Contact Retension to Housing: 17.79N (4 lb) min.
 Mating Force: Tin—4.15N (.93 lb) per circuit;
 Gold—3.08N (.70 lb) per circuit
 Unmating Force: Tin—2.47N (.55 lb) per circuit;
 Gold—.65N (.15 lb) per circuit
 Durability: Tin—25 cycles; Gold—50 cycles

Physical

Housing: Black polyester, UL 94V-0
 Contact: Copper Alloy
 Plating: See Table
 Insulation and Wire Gauge Range: .053" max. with
 22 to 28 AWG stranded discrete wire of flat
 ribbon cable

Delivered on a carrier with 20 pieces per strip.	
Actual Size	Universal Polarizing Pin
	40713-1
	Order No. 15-04-0292

Not For Use With C-Grid III™ Components

Wire Accommodation (AWG)	Order No.			Lead-free
	150µ" Tin	15µ" Gold	30µ" Gold	
28	14-60-1XX1	14-56-3XX8	14-56-4XX4	Yes
26	14-60-0XX9	14-56-3XX6	14-56-4XX2	
24	14-60-0XX7	14-56-3XX5	14-56-4XX0	
22	14-56-7XX0	14-56-7XX5	14-56-8XX0	

Replace XX with no. of circuits, 02-25

Plating Code (Stripe on Carrier Strip)	
Plating	Color
Tin	None
15µ" Gold	Yellow
30µ" Gold	Red

Wire Gauge Chart	
Code Stamped on Terminals	Wire Gauge (AWG)
A	24
B	26
C	28
D	22

Note: 2 circuit assemblies supplied as grouped pairs

2.54mm (.100") Pitch SL™ Insulation Displacement Connector Assembly

70400

**Female, Single Row
Version D, Back Ribs**

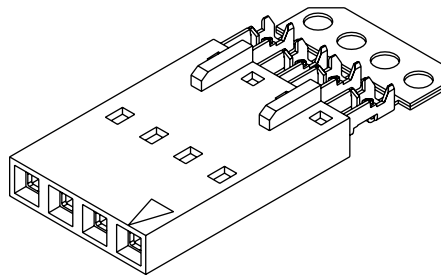

Features and Benefits

- Sizes 2 to 25 circuits
- Preloaded, single piece construction allows for fully automated termination
- Packaged in plastic tubes to allow for automated manufacturing and to minimize product handling
- Back ribs maintain position of connector assembly in clips and prevent lateral movement when another assembly is removed
- End-to-end stackable inside a single row interim clip to form a larger single row connector
- Back-to-back and end-to-end stackable inside a dual row interim clip to form a dual row connector

Reference Information

Product Specification: PS-70400
 Packaging: Tube
 UL File No.: E29179
 CSA File No.: LR19980
 Accessories: Interim clips 70004 and 70013 to form female connector assembly
 Use With Molex Cable: 7234, 7307, 7560, 7767, 8867, 8996, 8997, 24241, 24327, 24369 and 24389
 Designed In: Inches

Electrical

Voltage: 250V
 Current: 1.2A—28 AWG; 1.8A—26 AWG
 3.0A—24 AWG; 3.0A—22 AWG
 Contact Resistance: 15 milliohms max.
 Dielectric Withstanding Voltage: 1500V
 Insulation Resistance: 10,000 Megohms min.

Mechanical

Contact Retention to Housing: 17.79N (4 lb) min.
 Mating Force: Tin—4.15N (.93 lb) per circuit;
 Gold—3.08N (.70 lb) per circuit
 Unmating Force: Tin—2.47N (.55 lb) per circuit;
 Gold—.65N (.15 lb) per circuit
 Durability: Tin—25 cycles; Gold—50 cycles

Physical

Housing: Black polyester, UL 94V-0
 Contact: Copper Alloy
 Plating: See Table
 Insulation and Wire Gauge Range: .053" max. with 22 to 28 AWG stranded discrete wire or flat ribbon cable

Delivered on a carrier with 20 pieces per strip.

Actual Size  **Universal Polarizing Pin 40713-1**
 Order No. 15-04-0292

Not For Use With C-Grid III™ Components

Wire Accommodation (AWG)	Order No.			Lead-free
	150µm Tin	15µm Gold	30µm Gold	
28	14-60-1XX2	14-56-3XX9	14-56-4XX5	Yes
26	14-60-1XX0	14-56-3XX7	14-56-4XX3	
24	14-60-0XX8	14-56-3XX4	14-56-4XX1	
22	14-56-7XX1	14-56-7XX6	14-56-8XX1	

Replace XX with no. of circuits, 02-25

Plating Code (Stripe on Carrier Strip)	
Plating	Color
Tin	None
15µm Gold	Yellow
30µm Gold	Red

Note: The circuit 1 indicator for the 70400D will be superseded by the circuit 1 indicator of the 70004 and 70013 interim clips

Wire Gauge Chart	
Code Stamped on Terminals	Wire Gauge (AWG)
A	24
B	26
C	28
D	22

Note: 2 circuit assemblies supplied as grouped pairs

2.54mm (.100") Pitch SL™ Insulation Displacement Connector Assembly

70400 Female, Single Row Version G, Positive Latch

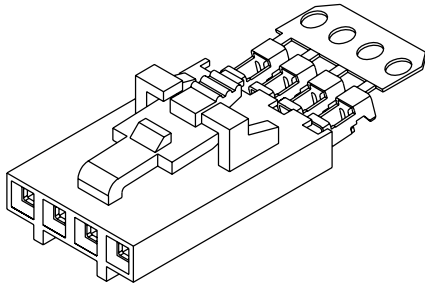

Features and Benefits

- Sizes 2 to 25 circuits
- Preloaded, single piece construction allows for fully automated termination
- Packaged in plastic tubes to allow for automated manufacturing and to minimize product handling
- Positive latch secures connector to mating header or panel mount
- Front ribs prevent housing from being twisted off pins
- Anti-entanglement/overstress ribs prevent discrete wires from catching under latch during harness manufacturing and storage

Reference Information

Product Specification: PS-70400
 Packaging: Tube
 UL File No.: E29179
 CSA File No.: LR19980
 Mates With: 70018, 70107 A/B, 70541, 70543, 70545, 70551, 70553, 70555, 70634 and 74099
 Use With Molex Cable: 7234, 7307, 7560, 7767, 8867, 8996, 8997, 24241, 24327, 24369 and 24389
 Designed In: Inches

Electrical

Voltage: 250V
 Current: 1.2A—28 AWG; 1.8A—26 AWG
 3.0A—24 AWG; 3.0A—22 AWG
 Contact Resistance: 15 milliohms max.
 Dielectric Withstanding Voltage: 1500V
 Insulation Resistance: 10,000 Megohms min.

Mechanical

Contact Retension to Housing: 17.79N (4 lb) min.
 Mating Force: Tin—4.15N (.93 lb) per circuit;
 Gold—3.08N (.70 lb) per circuit
 Unmating Force: Tin—2.47N (.55 lb) per circuit;
 Gold—.65N (.15 lb) per circuit
 Durability: Tin—25 cycles; Gold—50 cycles

Physical

Housing: Black polyester, UL 94V-0
 Contact: Copper Alloy
 Plating: See Table
 Insulation and Wire Gauge Range: .053" max. with 22 to 28 AWG stranded discrete wire or flat ribbon cable

Delivered on a carrier with 20 pieces per strip.

Actual Size  **Universal Polarizing Pin**
 40713-1
 Order No. 15-04-0292

Not For Use With C-Grid III™ Components

Wire Accommodation (AWG)	Order No.			Lead-free
	150µm Tin	15µm Gold	30µm Gold	
28	14-60-0XX6	14-56-2XX6	14-56-3XX3	Yes
26	14-60-0XX4	14-56-2XX4	14-56-3XX1	
24	14-60-0XX2	14-56-2XX2	14-56-2XX8	
22	14-56-7XX2	14-56-7XX7	14-56-8XX2	

Replace XX with no. of circuits, 02-25

Plating Code (Stripe on Carrier Strip)		Color
Plating		
Tin		None
15µm Gold		Yellow
30µm Gold		Red

Wire Gauge Chart	
Code Stamped on Terminals	Wire Gauge (AWG)
A	24
B	26
C	28
D	22

Note: 2 circuit assemblies supplied as grouped pairs

2.54mm (.100") Pitch SL™

Specifications for Male Insulation Displacement Connector Assembly

D

2.54mm (.100") Pitch PCB and Wire Connectors

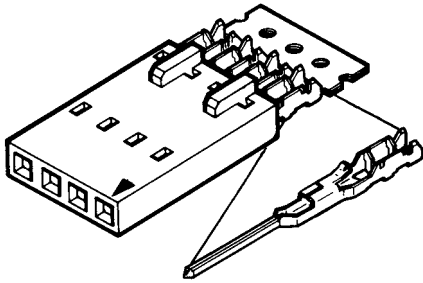

Shown: 70475 "D" Version Connector

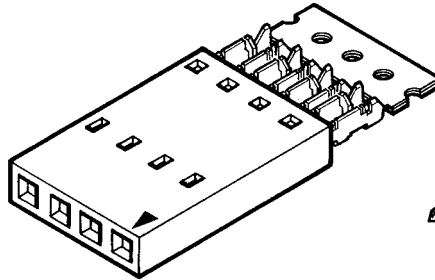

Stamped male terminals are preloaded into first window of housing for presentation of assemblies to application tooling. The carrier is color coded to identify the plating option, and the terminal is stamped with a letter code to distinguish wire gauge of the IDT slot.

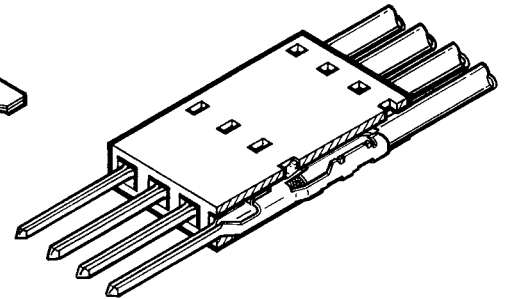

After the cable/wires are terminated, terminals are fully inserted into the housing and locked into the second window. The carrier strip is then broken off. As a result of this automated termination*, the terminals are consistently locked into the housing without damage.

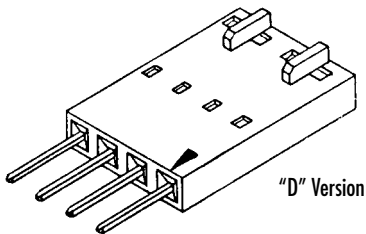

"D" Version

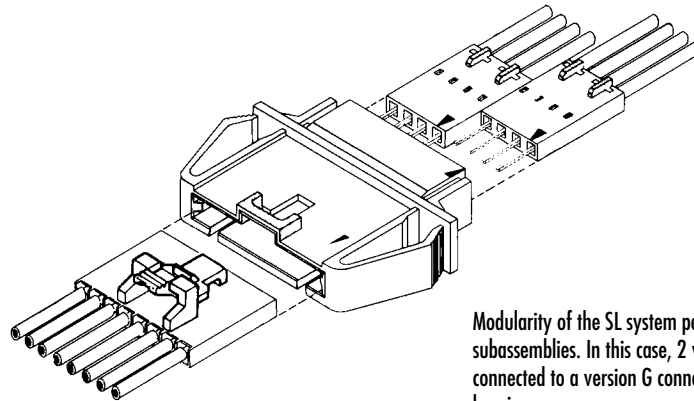

Modularity of the SL system permits gang loading of subassemblies. In this case, 2 version D pin assemblies are connected to a version G connector through a panel mount housing.

Wire and Cable Options

Recommended Molex Cable Engineering No. to use with 70400 Series connectors: 7234, 7307, 7560, 7767, 8867, 8996, 8997, 24241, 24327, 24369 and 24389

Notch Specification for Ribbon Cable

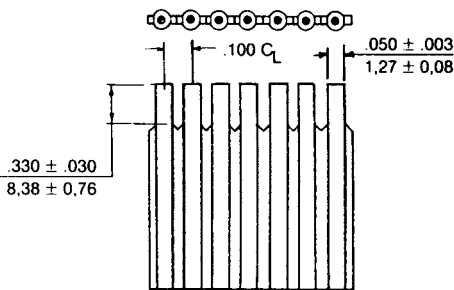

Discrete Wire
(Series 70066)

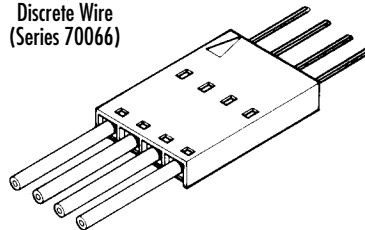

Flat Flex Cable
(Series 70431)

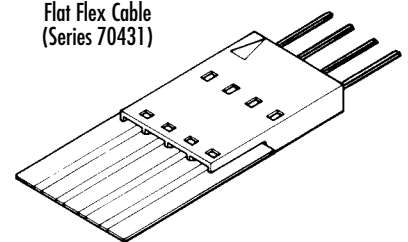

Ribbon Cable
(Series 70475)

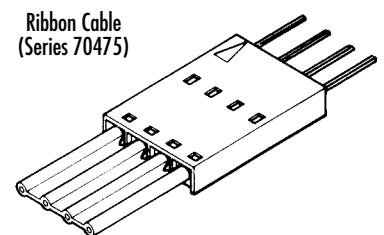

2.54mm (.100") Pitch SL™ Insulation Displacement Connector Assembly

70475

**Male, Single Row
Version D, Back Rib**

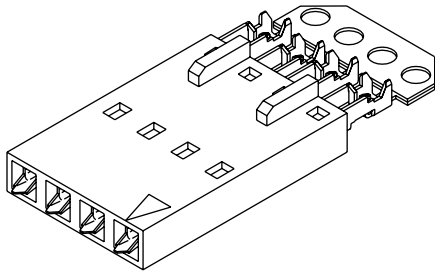

Features and Benefit

- Sizes 2 to 25 circuits
- Preloaded, single-piece construction allows for fully automated termination
- Packaged in plastic tubes to allow for automated manufacturing and to minimize product handling
- Back ribs maintain position of connector assembly in clips; prevents lateral movement when another assembly is removed
- End-to-end stackable inside a single row panel mount connector to form a larger single row connector
- Back-to-back and end-to-end stackable inside a dual row panel mount connector to form a dual row connector

Reference Information

Product Specification: PS-70475

Packaging: Tube

UL File No.: E29179

CSA File No.: LR19980

Accessories: Panel mount connectors 70018, 70022 and 70104 to form a male pin assembly

Mates with: 70058 and 71851 female crimp terminals, 70400 and 70430 connector assemblies and 0.64mm (.025") Square pins.

Use With Molex Cable: 7234, 7307, 7560, 7767, 8867, 8996, 8997, 24241, 24327, 24369 and 24389

Designed In: Inches

Electrical

Voltage: 250V

Current: 1.2A—28 AWG; 1.8A—26 AWG
3.0A—24 AWG; 3.0A—22 AWG

Contact Resistance: 15 milliohms max.

Dielectric Withstanding Voltage: 1500V

Insulation Resistance: 10,000 Megohms min.

Mechanical

Contact Retension to Housing: 17.79N (4 lb) min.

Mating Force: Tin—4.15N (.93 lb) per circuit;

Gold—3.08N (.70 lb) per circuit

Unmating Force: Tin—2.47N (.55 lb) per circuit;

Gold—.65N (.15 lb) per circuit

Durability: Tin—25 cycles; Gold—50 cycles

Physical

Housing: Black polyester, UL 94V-0

Contact: Copper Alloy

Plating: See Table

Insulation and Wire Gauge Range: .053" max. with 22 to 28 AWG stranded discrete wire or flat ribbon cable

Delivered on a carrier with 20 pieces per strip.

Actual
Size



Universal Polarizing Pin
40713-1

Order No. 15-04-0292

Not For Use With C-Grid III™ Components

Wire Accommodation (AWG)	Order No.			Lead-free
	150µm Tin	15µm Gold	30µm Gold	
28	14-45-18XX	14-44-21XX	14-44-49XX	Yes
26	14-45-06XX	14-44-16XX	14-44-29XX	
24	14-45-02XX	14-44-12XX	14-44-29XX	
22	14-44-52XX	14-44-53XX	14-44-54XX	

Replace XX with no. of circuits, 02-25

Housing version D mates with female connectors when used in panel mount

Plating Code (Stripe on Carrier Strip)	
Plating	Color
Tin	None
15µm Gold	Yellow
30µm Gold	Red

Wire Gauge Chart	
Code Stamped on Terminals	Wire Gauge (AWG)
A	24
B	26
C	28
D	22

Note: 2 circuit assemblies supplied as grouped pairs

2.54mm (.100") Pitch SL™ Wire-to-Wire Connector

70107 Single Row, Version A Without Mounting Ears

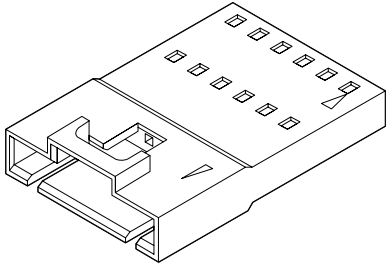

Not For Use With C-Grid III™ Components

Circuits	Order No.
2	70107-0001
3	70107-0002
4	70107-0003
5	70107-0004
6	70107-0005
7	70107-0006
8	70107-0007
9	70107-0008

Features and Benefits

- Sizes 2 to 25 circuits
- Used primarily for remote interconnections
- Locking crown secures positive latch to connector
- Polarization slots guide front ribs of mating connector to prevent pin damage

Reference Information

Product Specification: PS-70021
 Packaging: Bag
 UL File No.: E29179
 CSA File No.: LR19980
 Mates With: 70066G, 70066N, 70400G and 70430G
 connector assemblies
 Use With: 70021 crimp terminals
 Designed In: Inches

Physical

Housing: Black polyester, UL 94V-0

2.54mm (.100") Pitch SL™ Wire-to-Wire Panel Mount Connector

70107 Single Row, Version B With Mounting Ears

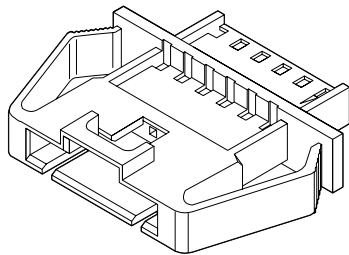

Not For Use With C-Grid III™ Components

Circuits	Order No.
2	70107-0036
3	70107-0037
4	70107-0038
5	70107-0039
6	70107-0040
7	70107-0041
8	70107-0042
9	70107-0043

Features and Benefits

- Sizes 2 to 25 circuits
- Used primarily for remote interconnections
- Locking crown secures positive latch to connector
- Polarization slots guide front ribs of mating connector to prevent pin damage
- Mounting ears for insertion into .030 to .090" thick panels

Reference Information

Product Specification: PS-70021
 Packaging: Bag
 UL File No.: E29179
 CSA File No.: LR19980
 Mates With: 70066G, 70066N, 70400G and 70430G
 connector assemblies
 Use With: 70021 crimp terminals
 Designed In: Inches

Physical

Housing: Black polyester, UL 94V-0

Circuits	Order No.
10	70107-0044
11	70107-0045
12	70107-0046
13	70107-0047
14	70107-0048
15	70107-0049
16	70107-0050
17	70107-0051

Circuits	Order No.
18	70107-0052
19	70107-0053
20	70107-0054
21	70107-0055
22	70107-0056
23	70107-0057
24	70107-0058
25	70107-0059

2.54mm (.100") Pitch SL™ Wire-to-Wire Panel Mount Connector

70018
Single Row
Modular Branch

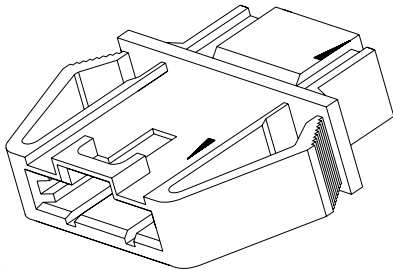

Features and Benefits

- Sizes 2 to 25 circuits
- Used primarily for remote interconnections
- Locking crown secures positive latch to connector
- Polarization slots guide front ribs of mating connector to prevent pin damage
- Mounting ears for insertion into .030 to .090" thick panels
- Mates modular branch pin assemblies to single connector assembly

Reference Information

Packaging: Bag
UL File No.: E29179
CSA File No.: LR19980
Mates With: 70066G, 70066N, 70400G and 70430G front side, and 70066D and 70475D pin assemblies back side
Designed In: Inches

Physical

Housing: Black polyester, UL 94V-0

Not For Use With Molex C-Grid III™ Components

Circuits	Order No.
2	50-65-0202
3	50-65-0203
4	50-65-0204
5	50-65-0205
6	50-65-0206
7	50-65-0207
8	50-65-0208
9	50-65-0209

Circuits	Order No.
10	50-65-0210
11	50-65-0211
12	50-65-0212
13	50-65-0213
14	50-65-0214
15	50-65-0215
16	50-65-0216
17	50-65-0217

Circuits	Order No.
18	50-65-0218
19	50-65-0219
20	50-65-0220
21	50-65-0221
22	50-65-0222
23	50-65-0223
24	50-65-0224
25	50-65-0225

2.54mm (.100") Pitch SL™ Wire-to-Wire Panel Mount Connector

70104
Single Row
Modular Branch

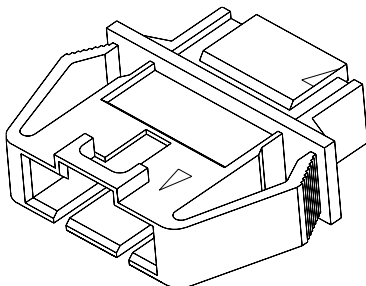

Features and Benefits

- Sizes 4 to 25 circuits
- Used primarily for remote interconnections
- Locking crown secures positive latch to connector
- Polarization slots guide front ribs of mating connector to prevent pin damage
- Mounting ears for insertion into .030 to .090" thick panels
- Mates single or modular branch pin assemblies with modular branch connector assemblies in an interim clip

Reference Information

Packaging: Bag
UL File No.: E29179
CSA File No.: LR19980
Mates With: 70004 front side, and 70066D and 70475D pin assemblies back side
Designed In: Inches

Physical

Housing: Black polyester, UL 94V-0

Not For Use With Molex C-Grid III™ Components

Circuits	Order No.
4	50-65-0104
5	50-65-0105
6	50-65-0106
7	50-65-0107
8	50-65-0108
9	50-65-0109
10	50-65-0110
11	50-65-0111

Circuits	Order No.
12	50-65-0112
13	50-65-0113
14	50-65-0114
15	50-65-0115
16	50-65-0116
17	50-65-0117
18	50-65-0118
19	50-65-0119

Circuits	Order No.
20	50-65-0120
21	50-65-0121
22	50-65-0122
23	50-65-0123
24	50-65-0124
25	50-65-0125

2.54mm (.100") Pitch SL™ Wire-to-Wire Panel Mount Connector

70022
Dual Row
Modular Branch

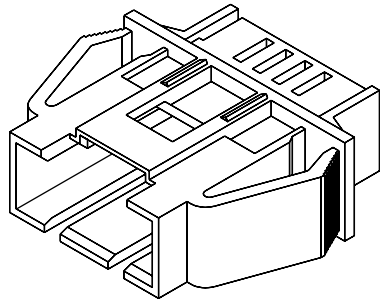

Not For Use With Molex C-Grid III™ Components

Circuits	Order No.
6	50-65-0006
8	50-65-0008
10	50-65-0010
12	50-65-0012
14	50-65-0014
16	50-65-0016
18	50-65-0018
20	50-65-0020

Features and Benefits

- Sizes 6 to 50 circuits
- Used primarily for high density remote interconnections
- Locking crown secures positive latch to connector
- Polarization slots guide front ribs of mating connector to prevent pin damage
- Mates modular branch pin assemblies to modular branch connector assemblies in a dual row configuration

Reference Information

Packaging: Bag
UL File No.: E29179
CSA File No.: LR19980
Mates With: 70013 interim clip front side, and side-to-side stacked 70066D and 70475D on back side
Designed In: Inches

Physical

Housing: Black polyester, UL 94V-0

2.54mm (.100") Pitch SL™ Interim Clip 70004 Single Row Modular Branch

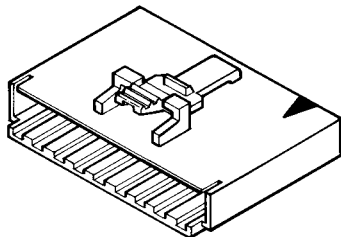

Not For Use With Molex C-Grid III™ Components

Circuits	Order No.
4	15-04-5042
5	15-04-5052
6	15-04-5062
7	15-04-5072
8	15-04-5082
9	15-04-5092
10	15-04-5102
11	15-04-5112

Features and Benefits

- Sizes 4 to 25 circuits
- Positive latch retains clip to panel mount or 180° pocket headers
- Anti-entanglement/overstress ribs prevent discrete wires from catching under latch during harness manufacturing and storage
- Stacks 70066/70400D assemblies end-to-end to form a larger single row connector

Reference Information

UL File No.: E29179
CSA File No.: LR19980
Mates With: 70104, 70563 and 70575
Designed In: Inches

Physical

Housing: Black polyester, UL 94V-0

Circuits	Order No.
22	50-65-0022
24	50-65-0024
26	50-65-0026
28	50-65-0028
30	50-65-0030
32	50-65-0032
34	50-65-0034
36	50-65-0036

Circuits	Order No.
38	50-65-0038
40	50-65-0040
42	50-65-0042
44	50-65-0051
46	50-65-0046
48	50-65-0048
50	50-65-0050

2.54mm (.100") Pitch

SL™

Interim Clip

70013

Dual Row

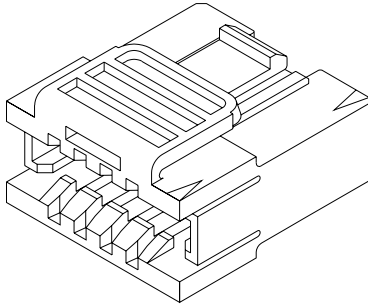

Not For Use With Molex C-Grid III™ Components

Circuits	Order No.	
	Version A Without Ribs	Version B With Ribs
6	15-04-5061	15-04-5064
8	15-04-5081	15-04-5084
10	15-04-5101	15-04-5104
12	15-04-5121	15-04-5124
14	15-04-5141	15-04-5144
16	15-04-5161	15-04-5164
18	15-04-5181	15-04-5184
20	15-04-5201	15-04-5204

Features and Benefits

- Sizes 6 to 50 circuits
- Positive latch retains clip to dual row panel mount or headers
- Optional front polarization rib available (version B)
- Stacks single row 70066/70400D assemblies side-to-side and end-to-end to form a larger dual row connector, accepts 70450C dual row connector to provide positive latch feature

Reference Information

Packaging: Bag
 UL File No.: E29179
 CSA File No.: LR19980
 Mates With: 70013, Version A—8724B and 70567B
 70013, Version B—70022, 70567C, 70568,
 71349 and 70229

Use With: 70066D housing and 70021 terminals, 70450C housing and 70021 terminals, 70430D and 70400D connector assemblies

Designed In: Inches

Physical

Housing: Black polyester, UL 94V-0

Circuits	Order No.	
	Version A Without Ribs	Version B With Ribs
22	15-04-5221	15-04-5224
24	15-04-5241	15-04-5244
26	15-04-5261	15-04-5264
28	15-04-5281	15-04-5284
30	15-04-5301	15-04-5304
32	15-04-5321	15-04-5324
34	15-04-5341	15-04-5344
36	15-04-5361	15-04-5364

Circuits	Order No.	
	Version A Without Ribs	Version B With Ribs
38	15-04-5381	15-04-5384
40	15-04-5401	15-04-5404
42	15-04-5421	15-04-5424
44	15-04-5441	15-04-5444
46	15-04-5461	15-04-5464
48	15-04-5481	15-04-5484
50	15-04-5501	15-04-5504

2.54mm (.100") Pitch

SL™

Wire-to-Board Shrouded Header

70543

Single Row, .120" Pocket Vertical

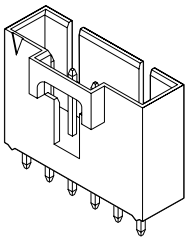

Not For Use With C-Grid III™ Components

Circuits	Order No.			Lead-free
	150µm Tin	15µm Gold	30µm Gold	
2	70543-0036	70543-0001	70543-0106	Yes
3	70543-0037	70543-0002	70543-0107	
4	70543-0038	70543-0003	70543-0108	
5	70543-0039	70543-0004	70543-0109	
6	70543-0040	70543-0005	70543-0110	
7	70543-0041	70543-0006	70543-0111	
8	70543-0042	70543-0007	70543-0112	
9	70543-0043	70543-0008	70543-0113	
10	70543-0044	70543-0009	70543-0114	
11	70543-0045	70543-0010	70543-0115	
12	70543-0046	70543-0011	70543-0116	
13	70543-0047	70543-0012	70543-0117	

Features and Benefits

- Sizes 2 to 25 circuits
- Locking crown secures positive latch to header
- Polarization slots guide front ribs of mating connector to prevent pin damage
- Standoffs minimize flux retention

Reference Information

Product Specification: PS-70541
 Packaging: Tube
 UL File No.: E29179
 CSA File No.: LR19980
 Mates With: 70066G, 70066N, 70400G and 70430G
 Designed In: Inches

Electrical

Voltage: 250V
 Current: 3.0A
 Contact Resistance: 15 milliohms max.
 Dielectric Withstanding Voltage: 1500V
 Insulation Resistance: 10,000 Megohms min.

Mechanical

Durability: Tin—25 cycles; Gold—50 cycles

Physical

Housing: Black polyester, UL 94V-0
 Contact: Copper Alloy
 Plating: See Table

Circuits	Order No.			Lead-free
	150µm Tin	15µm Gold	30µm Gold	
14	70543-0048	70543-0013	70543-0118	Yes
15	70543-0049	70543-0014	70543-0119	
16	70543-0050	70543-0015	70543-0120	
17	70543-0051	70543-0016	70543-0121	
18	70543-0052	70543-0017	70543-0122	
19	70543-0053	70543-0018	70543-0123	
20	70543-0054	70543-0019	70543-0124	
21	70543-0055	70543-0020	70543-0125	
22	70543-0056	70543-0021	70543-0126	
23	70543-0057	70543-0022	70543-0127	
24	70543-0058	70543-0023	70543-0128	
25	70543-0059	70543-0024	70543-0129	

2.54mm (.100") Pitch SL™ Wire-to-Board Shrouded Header

74099

Single Row, .120" Pocket
Vertical, SMT

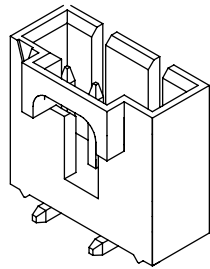

Features and Benefits

- Size 3 to 24 circuits
- Locking crown secures positive latch to header
- Polarization slots guide front ribs of mating connector to prevent pin damage
- Standoffs minimize flux interference
- Surface Mount Compatible

Reference Information

Product Specification: PS-70541
Packaging: Tube
UL File No.: E29179
CSA File No.: LR19980
Mates with: 70066G, 70066N, 70400G and 70430G
Designed In: Inches

Electrical

Voltage: 250V
Current: 3.0A
Contact Resistance: 15 milliohms max.
Dielectric Withstanding Voltage: 1500V
Insulation Resistance: 1000 Megohms min.

Mechanical

Durability: Tin—25 cycles; Gold—50 cycles

Physical

Housing: Black polyester, UL 94V-0
Contact: Copper Alloy
Plating: See Table

Not For Use With C-Grid III™ Components

	Tin	15µl" Gold	30µl" Gold	Lead-free
3	74099-0003	74099-1003	74099-2003	Yes
4	74099-0004	74099-1004	74099-2004	
5	74099-0005	74099-1005	74099-2005	
6	74099-0006	74099-1006	74099-2006	
7	74099-0007	74099-1007	74099-2007	
8	74099-0008	74099-1008	74099-2008	
9	74099-0009	74099-1009	74099-2009	
10	74099-0010	74099-1010	74099-2010	
11	74099-0011	74099-1011	74099-2011	
12	74099-0012	74099-1012	74099-2012	
13	74099-0013	74099-1013	74099-2013	

	Tin	15µl" Gold	30µl" Gold	Lead-free
14	74099-0014	74099-1014	74099-2014	Yes
15	74099-0015	74099-1015	74099-2015	
16	74099-0016	74099-1016	74099-2016	
17	74099-0017	74099-1017	74099-2017	
18	74099-0018	74099-1018	74099-2018	
19	74099-0019	74099-1019	74099-2019	
20	74099-0020	74099-1020	74099-2020	
21	74099-0021	74099-1021	74099-2021	
22	74099-0022	74099-1022	74099-2022	
23	74099-0023	74099-1023	74099-2023	
24	74099-0024	74099-1024	74099-2024	

2.54mm (.100") Pitch SL™ Wire-to-Board Shrouded Header

70541

Single Row, .120" Pocket
Vertical, Split Pegs

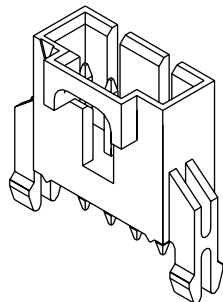

Features and Benefits

- Size 2 to 10 circuits
- PCB locks hold header in place until permanently soldered
- Locking crown secures positive latch to header
- Polarization slots guide front ribs of mating connector to prevent pin damage
- Standoffs minimize flux retention

Reference Information

Product Specification: PS-70541
Packaging: Tube
UL File No.: E29179
CSA File No.: LR19980
Mates With: 70066G, 70066N, 70400G and 70430G
Designed In: Inches

Electrical

Voltage: 250V
Current: 3.0A
Contact Resistance: 15 milliohms max.
Dielectric Withstanding Voltage: 1500V
Insulation Resistance: 1000 Megohms min.

Mechanical

Insertion Force to PCB: 44.5 N (10 lb)
Durability: Tin—25 cycles; Gold—50 cycles

Physical

Housing: Black polyester, UL 94V-0
Contact: Copper Alloy
Plating: See Table

Not For Use With C-Grid III™ Components

Circuits	Order No.			Lead-free
	15µl" Min. Gold	30µl" Min. Gold	150µl" Tin	
2	70541-0036	70541-0071	70541-0001	Yes
3	70541-0037	70541-0072	70541-0002	
4	70541-0038	70541-0073	70541-0003	
5	70541-0039	70541-0074	70541-0004	
6	70541-0040	70541-0075	70541-0005	

Circuits	Order No.			Lead-free
	15µl" Min. Gold	30µl" Min. Gold	150µl" Tin	
7	70541-0041	70541-0076	70541-0006	Yes
8	70541-0042	70541-0077	70541-0007	
9	70541-0043	70541-0078	70541-0008	
10	70541-0044	70541-0079	70541-0009	

2.54mm (.100") Pitch SL™ Wire-to-Board Shrouded Header

70545
Single Row, .120" Pocket
Vertical, Tri-Peg

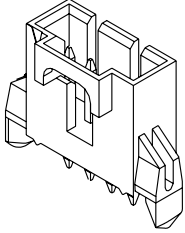

Features and Benefits

- Size 2 to 25 circuits
- PCB locks hold header in place until permanently soldered
- Locking crown secures positive latch to header
- Polarization slots guide front ribs of mating connector to prevent pin damage
- Standoffs minimize flux retention

Reference Information

Product Specification: PS-70541
Packaging: Tube
UL File No.: E29179
CSA File No.: LR19980
Mates With: 70066G, 70066N, 70400G and 70430G
Designed In: Inches

Electrical

Voltage: 250V
Current: 3.0A
Contact Resistance: 15 milliohms max.
Dielectric Withstanding Voltage: 1500V
Insulation Resistance: 10,000 Megohms min.

Mechanical

Insertion Force to PCB: 44.50N (10 lb)
Durability: Tin—25 cycles; Gold—50 cycles

Physical

Housing: Black polyester, UL 94V-0
Contact: Copper Alloy
Plating: See Table

Not For Use With C-Grid III™ Components

Circuits	Order No.			Lead-free
	150µm Tin	15µm Gold	30µm Gold	
2	70545-0001	70545-0036	70545-0071	Yes
3	70545-0002	70545-0037	70545-0072	
4	70545-0003	70545-0038	70545-0073	
5	70545-0004	70545-0039	70545-0074	
6	70545-0005	70545-0040	70545-0075	
7	70545-0006	70545-0041	70545-0076	
8	70545-0007	70545-0042	70545-0077	
9	70545-0008	70545-0043	70545-0078	
10	70545-0009	70545-0044	70545-0079	
11	70545-0010	70545-0045	70545-0080	
12	70545-0011	70545-0046	70545-0081	
13	70545-0012	70545-0047	70545-0082	

Circuits	Order No.			Lead-free
	150µm Tin	15µm Gold	30µm Gold	
14	70545-0013	70545-0048	70545-0083	Yes
15	70545-0014	70545-0049	70545-0084	
16	70545-0015	70545-0050	70545-0085	
17	70545-0016	70545-0051	70545-0086	
18	70545-0017	70545-0052	70545-0087	
19	70545-0018	70545-0053	70545-0088	
20	70545-0019	70545-0054	70545-0089	
21	70545-0020	70545-0055	70545-0090	
22	70545-0021	70545-0056	70545-0091	
23	70545-0022	70545-0057	70545-0092	
24	70545-0023	70545-0058	70545-0093	
25	70545-0024	70545-0059	70545-0094	

2.54mm (.100") Pitch SL™ Wire-to-Board Shrouded Header

70553
Single Row, .120" Pocket
Right Angle, Low Profile

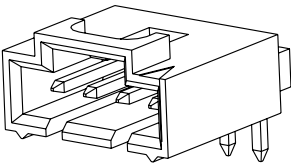

Features and Benefits

- Sizes 2 to 25 circuits
- Locking crown secures positive latch to header
- Polarization slots guide front ribs of mating connector to prevent pin damage
- Standoffs minimize flux retention

Reference Information

Product Specification: PS-70541
Packaging: Tube
UL File No.: E29179
CSA File No.: LR19980
Mates With: 70066G, 70066N, 70400G and 70430G
Designed In: Inches

Electrical

Voltage: 250V
Current: 3.0A
Contact Resistance: 15 milliohms max.
Dielectric Withstanding Voltage: 1500V
Insulation Resistance: 10,000 Megohms min.

Mechanical

Durability: Tin—25 cycles; Gold—50 cycles

Physical

Housing: Black polyester, UL 94V-0
Contact: Copper Alloy
Plating: See Table

Not For Use With C-Grid III™ Components

Circuits	Order No.			Lead-free
	150µm Tin	15µm Gold	30µm Gold	
2	70553-0036	70553-0001	70553-0106	Yes
3	70553-0037	70553-0002	70553-0107	
4	70553-0038	70553-0003	70553-0108	
5	70553-0039	70553-0004	70553-0109	
6	70553-0040	70553-0005	70553-0110	
7	70553-0041	70553-0006	70553-0111	
8	70553-0042	70553-0007	70553-0112	
9	70553-0043	70553-0008	70553-0113	
10	70553-0044	70553-0009	70553-0114	
11	70553-0045	70553-0010	70553-0115	
12	70553-0046	70553-0011	70553-0116	
13	70553-0047	70553-0012	70553-0117	

Circuits	Order No.			Lead-free
	150µm Tin	15µm Gold	30µm Gold	
14	70553-0048	70553-0013	70553-0118	Yes
15	70553-0049	70553-0014	70553-0119	
16	70553-0050	70553-0015	70553-0120	
17	70553-0051	70553-0016	70553-0121	
18	70553-0052	70553-0017	70553-0122	
19	70553-0053	70553-0018	70553-0123	
20	70553-0054	70553-0019	70553-0124	
21	70553-0055	70553-0020	70553-0125	
22	70553-0056	70553-0021	70553-0126	
23	70553-0057	70553-0022	70553-0127	
24	70553-0058	70553-0023	70553-0128	
25	70553-0059	70553-0024	70553-0129	

2.54mm (.100") Pitch SL™ Wire-to-Board Shrouded Header

70551
Single Row, .120" Pocket
Right Angle, Split Peg

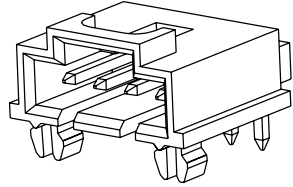

Features and Benefits

- Sizes 2 to 25 circuits
- PCB locks hold header in place until permanently soldered
- Locking crown secures positive latch connector to header
- Polarization slots guide front ribs of mating connector to prevent pin damage
- Standoffs minimize flux retention

Reference Information

Product Specification: PS-70541
Packaging: Tube
UL File No.: E29179
CSA File No.: LR19980
Mates with: 70066, 70066N, 70400 and 70430G
Designed in: Inches

Electrical

Voltage: 250V
Current: 3.0A
Contact Resistance: 15 milliohms max.
Dielectric Withstanding Voltage: 1500V
Insulation Resistance: 10,000 Megohms min.

Mechanical

Insertion force to PCB: 44.48N (10 lbs.)
Durability: Tin — 25 cycles; Gold — 50 cycles

Physical

Housing: Black polyester, UL 94V-0
Contact: Copper Alloy
Plating: See Table

Circuits	Order No.			Lead-free
	150µm Tin	15µm Gold	30µm Gold	
2	70551-0001	70551-0036	70551-0071	Yes
3	70551-0002	70551-0037	70551-0072	
4	70551-0003	70551-0038	70551-0073	
5	70551-0004	70551-0039	70551-0074	
6	70551-0005	70551-0040	70551-0075	
7	70551-0006	70551-0041	70551-0076	
8	70551-0007	70551-0042	70551-0077	
9	70551-0008	70551-0043	70551-0078	
10	70551-0009	70551-0044	70551-0079	
11	70551-0010	70551-0045	70551-0080	
12	70551-0011	70551-0046	70551-0081	
13	70551-0012	70551-0047	70551-0082	

Circuits	Order No.			Lead-free
	150µm Tin	15µm Gold	30µm Gold	
14	70551-0013	70551-0048	70551-0083	Yes
15	70551-0014	70551-0049	70551-0084	
16	70551-0015	70551-0050	70551-0085	
17	70551-0016	70551-0051	70551-0086	
18	70551-0017	70551-0052	70551-0087	
19	70551-0018	70551-0053	70551-0088	
20	70551-0019	70551-0054	70551-0089	
21	70551-0020	70551-0055	70551-0090	
22	70551-0021	70551-0056	70551-0091	
23	70551-0022	70551-0057	70551-0092	
24	70551-0023	70551-0058	70551-0093	
25	70551-0024	70551-0059	70551-0094	

2.54mm (.100") Pitch SL™ Wire-to-Board Shrouded Header

70555
Single Row, .120" Pocket
Right Angle, Low Profile
Tri-Peg

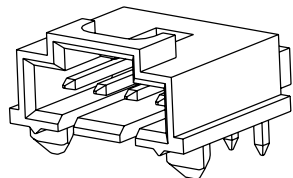

Features and Benefits

- Sizes 2 to 25 circuits
- PCB locks hold header in place until permanently soldered
- Locking crown secures positive latch to header
- Polarization slots guide front ribs of mating connector to prevent pin damage
- Standoffs minimize flux retention

Reference Information

Product Specification: PS-70541
Packaging: Tube
UL File No.: E29179
CSA File No.: LR19980
Mates With: 70066G, 70066N, 70400G and 70430G
Designed In: Inches

Electrical

Voltage: 250V
Current: 3.0A
Contact Resistance: 15 milliohms max.
Dielectric Withstanding Voltage: 1500V
Insulation Resistance: 10,000 Megohms min.

Mechanical

Insertion Force to PCB: 44.50N (10 lb)
Durability: Tin—25 cycles; Gold—50 cycles

Physical

Housing: Black polyester, UL 94V-0
Contact: Copper Alloy
Plating: See Table

Not For Use With C-Grid III™ Components

Circuits	Order No.			Lead-free
	150µm Tin	15µm Gold	30µm Gold	
2	70555-0001	70555-0036	70555-0071	Yes
3	70555-0002	70555-0037	70555-0072	
4	70555-0003	70555-0038	70555-0073	
5	70555-0004	70555-0039	70555-0074	
6	70555-0005	70555-0040	70555-0075	
7	70555-0006	70555-0041	70555-0076	
8	70555-0007	70555-0042	70555-0077	
9	70555-0008	70555-0043	70555-0078	
10	70555-0009	70555-0044	70555-0079	
11	70555-0010	70555-0045	70555-0080	
12	70555-0011	70555-0046	70555-0081	
13	70555-0012	70555-0047	70555-0082	

Circuits	Order No.			Lead-free
	150µm Tin	15µm Gold	30µm Gold	
14	70555-0013	70555-0048	70555-0083	Yes
15	70555-0014	70555-0049	70555-0084	
16	70555-0015	70555-0050	70555-0085	
17	70555-0016	70555-0051	70555-0086	
18	70555-0017	70555-0052	70555-0087	
19	70555-0018	70555-0053	70555-0088	
20	70555-0019	70555-0054	70555-0089	
21	70555-0020	70555-0055	70555-0090	
22	70555-0021	70555-0056	70555-0091	
23	70555-0022	70555-0057	70555-0092	
24	70555-0023	70555-0058	70555-0093	
25	70555-0024	70555-0059	70555-0094	

2.54mm (.100") Pitch SL™ Wire-to-Board Shrouded Header

70634
Single Row, .120" Pocket
Right Angle, Low Profile
SMT with Tri Peg

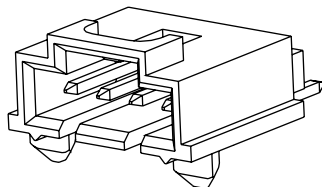

Features and Benefits

- Sizes 2 to 25 circuits
- Press-fit peg maximizes retention to PCB during soldering process
- Locking crown secures positive latch to header
- Standoffs minimize flux interference

Reference Information

Product Specification: PS-70541
Packaging: Tube
UL File No.: E29179
CSA File No.: LR19980
Mates with: 70066G, 70066N, 70400G and 70430G
Designed in: Inches

Electrical

Voltage: 250V
Current: 3.0A
Contact Resistance: 15 milliohms max.
Dielectric Withstanding Voltage: 1500V
Insulation Resistance: 10,000 Megohms min.

Mechanical

Insertion force to PCB: 44.48N (10 lbs.)
Durability: Tin — 25 cycles; Gold — 50 cycles

Physical

Housing: Black polyester, UL 94V-0
Contact: Copper Alloy

Circuits	Order No.			Lead-free
	Tin	15µ" Gold	30µ" Gold	
2	15-91-3024	15-91-2025	15-91-3023	Yes
3	15-91-3034	15-91-2035	15-91-3033	
4	15-91-3044	15-91-2045	15-91-3043	
5	15-91-3054	15-91-2055	15-91-3053	
6	15-91-3064	15-91-2065	15-91-3063	
7	15-91-3074	15-91-2075	15-91-3073	
8	15-91-3084	15-91-2085	15-91-3083	
9	15-91-3094	15-91-2095	15-91-3093	
10	15-91-3104	15-91-2105	15-91-3103	
11	15-91-3114	15-91-2115	15-91-3113	
12	15-91-3124	15-91-2125	15-91-3123	
13	15-91-3134	15-91-2135	15-91-3133	

Circuits	Order No.			Lead-free
	Tin	15µ" Gold	30µ" Gold	
14	15-91-3144	15-91-2145	15-91-3143	Yes
15	15-91-3154	15-91-2155	15-91-3153	
16	15-91-3164	15-91-2165	15-91-3163	
17	15-91-3174	15-91-2175	15-91-3173	
18	15-91-3184	15-91-2185	15-91-3183	
19	15-91-3194	15-91-2195	15-91-3193	
20	15-91-3204	15-91-2205	15-91-3203	
21	15-91-3214	15-91-2215	15-91-3213	
22	15-91-3224	15-91-2225	15-91-3223	
23	15-91-3234	15-91-2235	15-91-3233	
24	15-91-3244	15-91-2245	15-91-3243	
25	15-91-3254	15-91-2255	15-91-3253	

www.molex.com/product/sl_products.html

2.54mm (.100") Pitch C-Grid® Breakaway Header

70280
Dual Row, Vertical
High-Temperature

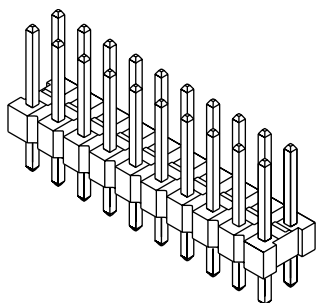

Features and Benefits

- Sizes 4 to 100 circuits
- Stackable side-to-side and end-to-end (on unbroken edges)
- Easy breakaway to smaller sizes
- Drawn .025" square wire provides 4-sided smooth surface for quality interface

Reference Information

Product Specifications: PS-70280
Packaging: Bag or tube
UL File No.: E29179
CSA File No.: LR19980
Mates With: 7859 Shunts, C-Grid Receptacles, SL Crimp, FFC and IDT Housings
Designed In: Inches

Electrical

Voltage: 250V
Current: 3.0A
Contact Resistance: 15 milliohms max.
Dielectric Withstanding Voltage: 1500V
Insulation Resistance: 1000 Megohms min.

Mechanical

Pin Retention to Header: 17.79N (4 lb)
Durability: Tin—25 cycles; Gold—50 cycles

Physical

Housing: Black high-temperature thermal plastic, UL 94V-0
Contact: Copper Alloy
Plating: See Table

Not For Use With Molex C-Grid III™ Components

Plating Option	Order No.	Lead-free
150µ" Tin	10-89-7XX1	Yes
15µ" Gold	10-89-7XX2	
30µ" Gold	10-89-7XX0	

Replace XX with no. of circuits, 04-80 (even only). See sales drawing for 82-100.

2.54mm (.100") Pitch C-Grid® Breakaway Header

75102 Dual Row Vertical, CPI

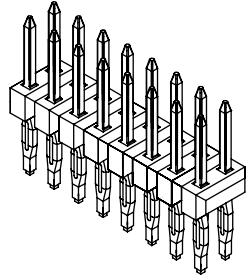

Features and Benefits

- Size 4 to 80 circuits
- Stackable side-to-side and end-to-end (on unbroken edges)
- Easy breakaway to smaller sizes
- Eye-of-the-needle compliant pin for press-fit applications

Reference Information

Product Specification: PS-75100-001
 Packaging: Bag
 UL File No.: E29179
 CSA File No.: LR19980
 Mates With: 7859 shunts, C-Grid receptacles, SL crimp,
 FFC and IDT housings
 Designed In: Inches

Electrical

Voltage: 250V
 Current: 3.0A
 Contact Resistance: 10 milliohms max.
 Dielectric Withstanding Voltage: 1500V
 Insulation Resistance: 1000 Megohms min.

Mechanical

Durability: Tin—25 cycles; Gold—50 cycles

Physical

Housing: Black Polyester, UL 94V-0
 Contact: Copper Alloy
 Plating: See table

Not For Use With C-Grid III™ Components

Circuits	Order No.			Lead-free
	Tin	15" Gold	30" Gold	
4	75102-0079	75102-0040	75102-0001	Yes
6	75102-0080	75102-0041	75102-0002	
8	75102-0081	75102-0042	75102-0003	
10	75102-0082	75102-0043	75102-0004	
12	75102-0083	75102-0044	75102-0005	
14	75102-0084	75102-0045	75102-0006	
16	75102-0085	75102-0046	75102-0007	
18	75102-0086	75102-0047	75102-0008	
20	75102-0087	75102-0048	75102-0009	
22	75102-0088	75102-0049	75102-0010	
24	75102-0089	75102-0050	75102-0011	
26	75102-0090	75102-0051	75102-0012	
28	75102-0091	75102-0052	75102-0013	
30	75102-0092	75102-0053	75102-0014	
32	75102-0093	75102-0054	75102-0015	
34	75102-0094	75102-0055	75102-0016	
36	75102-0095	75102-0056	75102-0017	
38	75102-0096	75102-0057	75102-0018	
40	75102-0097	75102-0058	75102-0019	
42	75102-0098	75102-0059	75102-0020	
44	75102-0099	75102-0060	75102-0021	
46	75102-0100	75102-0061	75102-0022	
48	75102-0101	75102-0062	75102-0023	
50	75102-0102	75102-0063	75102-0024	
52	75102-0103	75102-0064	75102-0025	
54	75102-0104	75102-0065	75102-0026	
56	75102-0105	75102-0066	75102-0027	
58	75102-0106	75102-0067	75102-0028	
60	75102-0107	75102-0068	75102-0029	
62	75102-0108	75102-0069	75102-0030	
64	75102-0109	75102-0070	75102-0031	
66	75102-0110	75102-0071	75102-0032	
68	75102-0111	75102-0072	75102-0033	
70	75102-0112	75102-0073	75102-0034	
72	75102-0113	75102-0074	75102-0035	
74	75102-0114	75102-0075	75102-0036	
76	75102-0115	75102-0076	75102-0037	
78	75102-0116	75102-0077	75102-0038	
80	75102-0117	75102-0078	75102-0039	

2.54mm (.100") Pitch C-Grid® Breakaway Header

71308

Dual Row, SMT, Vertical
With or Without Peg

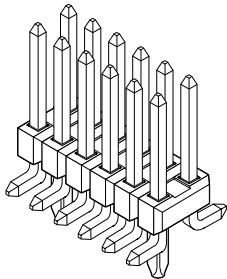

Features and Benefits

- Available with or without retention pegs
- Gull wing surface mount tails
- Vapor phase/IR reflow process compatible
- Stackable end-to-end (on unbroken edges)
- Drawn .025" square wire provides 4-sided smooth interface

Reference Information

Product Specification: PS-71308
Packaging: Tube, tape and reel* or bag
UL File No.: E29179
CSA File No.: LR19980
Mates With: 7859 Shunts, C-Grid Receptacles, SL Crimp, FFC and IDT Housings
Designed In: Inches

* Contact Molex for tape and reel order numbers

Electrical

Voltage: 250V
Current: 3.0A
Contact Resistance: 15 milliohms max.
Dielectric Withstanding Voltage: 1500V
Insulation Resistance: 1000 Megohms min.

Mechanical

Pin Retention to Header: 17.79N (4 lb)
Insertion Force to PCB: 35.58N (8 lb) per peg
Durability: Tin—25 cycles; Gold—50 cycles

Physical

Housing: Black high-temperature thermal plastic, UL 94V-0
Contact: Copper Alloy
Plating: See Table
Screened Paste Thickness: .010 to .015"

Not For Use With Molex C-Grid III™ Components

Plating Option	Order No.		Lead-free
	Without PCB Retention Pegs	With PCB Retention Pegs	
150µm Tin	15-91-2XX0	15-91-1XX1	Yes
15µm Gold	15-91-0XX0	15-91-1XX2	
30µm Gold	15-91-3XX0	15-91-1XX3	

Replace XX with no. of circuits, 04-80 (even only). See Sales drawing for 82-100.

2.54mm (.100") C-Grid® Breakaway Header

71764

Low Profile, Dual Row
Right Angle,
High-Temperature

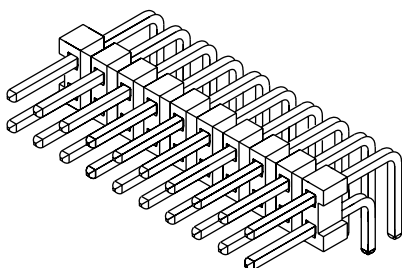

Features and Benefits

- Sizes 4 to 30 circuits
- Low profile: .200" high
- Stackable end-to-end (on unbroken edges)
- Easy breakaway to smaller sizes
- Drawn .025" square wire provides 4-sided smooth surface for quality interface
- High-temperature wafer for SMT compatibility

Reference Information

Product Specification: PS-71764
Packaging: Tube or bag
UL File No.: E29179
Mates With: 7859 Shunts, C-Grid Receptacles, SL Crimp, FFC and IDT Housings
Designed In: Inches

Electrical

Voltage: 250V
Current: 3.0A
Contact Resistance: 15 milliohms max.
Dielectric Withstanding Voltage: 1500V
Insulation Resistance: 1000 Megohms min.

Mechanical

Pin Retention to Header: 17.79N (4 lb)
Durability: Tin—25 cycles; Gold—50 cycles

Physical

Housing: Black high-temperature thermal plastic, UL 94V-0
Contact: Copper Alloy
Plating: See Table

Not For Use With Molex C-Grid III™ Components

Plating Option	Order No.	Lead-free
15µm min. select Gold	71764-01XX	Yes
30µm min. select Gold	71764-02XX	
150µm Tin/Lead, Nickel overall	71764-00XX	

Replace XX with no. of circuits, 04-30 (even only)

2.54mm (.100") Pitch C-Grid® Breakaway Header

70216

High Profile, Dual Row
Right Angle

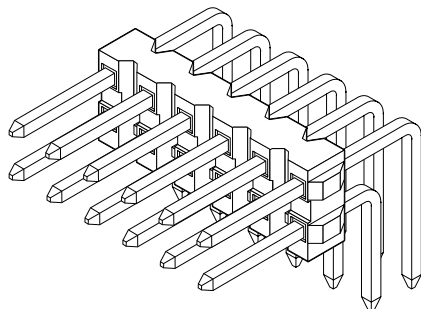

Features and Benefits

- Sizes 4 to 30 circuits
- High profile: .220" high
- Stackable end-to-end (on unbroken edges)
- Easy breakaway to smaller sizes
- Drawn .025" square wire provides 4-sided smooth surface for quality interface

Reference Information

Product Specification: PS-70216
 Packaging: Tube or bag
 UL File No.: E29179
 CSA File No.: LR19980
 Mates With: 7859 Shunts, C-Grid Receptacles, SL Crimp, FFC and IDT Housings
 Designed In: Inches

Electrical

Voltage: 250V
 Current: 3.0A
 Contact Resistance: 15 milliohms max.
 Dielectric Withstanding Voltage: 1500V
 Insulation Resistance: 1000 Megohms min.

Mechanical

Pin Retention to Header: 17.79N (4 lb)
 Durability: Tin—25 cycles; Gold—50 cycles

Physical

Housing: Black glass-filled polyester, UL 94V-0
 Contact: Copper Alloy
 Plating: See Table

Not For Use With Molex C-Grid III™ Components

Plating Option	Order No.	Lead-free
150µ" Tin	10-88-3XX1	Yes
15µ" Gold	10-89-4XX2	
30µ" Gold	10-89-4XX6	
Replace XX with no. of circuits, 04-30 (even only)		

2.54mm (.100") Pitch C-Grid® Shrouded Header

8724

Dual Row
Right Angle

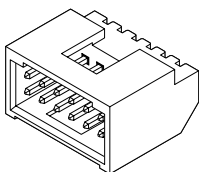

Features and Benefits

- Polarized
- Latch window retains positive lock on 70013 after mating
- 4 wall shielding provides unmated pin protection
- Standoffs minimize flux retention
- 4-sided smooth surface pin for quality interface

Reference Information

Product Specification: PS-8723
 Packaging: Tube
 UL File No.: E29179
 Mates With: 8724 Version A—C-Grid Receptacles and 70450A crimp housing
 8724 Version B—70013A (10 to 50 circuits)
 Designed In: Inches

Electrical

Voltage: 250V
 Current: 3.0A
 Contact Resistance: 15 milliohms max.
 Dielectric Withstanding Voltage: 1500V
 Insulation Resistance: 1000 Megohms min.

Mechanical

Pin Retention to Housing: 17.79N (4 lb)
 Durability: Tin—25 cycles; Gold—50 cycles

Physical

Housing: Black nylon, UL 94V-0
 Contact: Copper Alloy
 Plating: See Table

Not For Use With C-Grid III™ Components

Plating Option	Order No.		Lead-free
	Version A* Pin to Side Wall Distance = 1.68mm (.066")	Version B Pin to Side Wall Distance = 3.81mm (.150")	
150µ" Tin	15-42-70XX	15-42-72XX	Yes
15µ" Gold	15-29-70XX	15-29-72XX	
30µ" Gold	15-41-80XX	15-41-82XX	
Replace XX with no. of circuits, 06-72 (even only)			

Note: No latching window available for 6-circuit and 8-circuit—Version A; No latching window available for 6-circuit—Version B

* Version A is never to be used with interim clips

2.54mm (.100") Pitch C-Grid® Shrouded Header

70567 Dual Row, High-Temperature Through Hole without Pegs Vertical

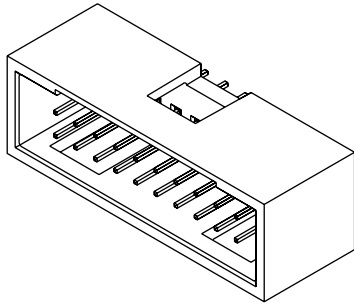

Plating Option	Order No.	Lead-free
	End Wall = 1.68mm (.066")	
15µ" min. select Gold	15-80-0XX3	Yes
30µ" min. select Gold	15-80-0XX5	
150µ" Tin/Lead	15-80-0XX1	
Replace XX with no. of circuits, 06-72 (even only)		

Features and Benefits

- Sizes 6 to 72 circuits
- Robotically insertable and compatible
- Board retention pegs hold header in place until they are permanently secured by soldering
- Latch window retains modular connector assemblies after mating
- Standoffs minimize flux retention
- Drawn .025" square wire provides 4-sided smooth surface for quality interface

Reference Information

Product Specification: PS-70567
 Packaging: Tube
 Mates With:
 Version A—C-Grid receptacles, 70450A crimp housing
 Version B—70013A (10-50 circuits)
 Version C—70013B (10-50 circuits)
 Designed In: Inches

Electrical

Voltage: 250V
 Current: 3.0A
 Contact Resistance: 15 milliohms max.
 Dielectric Withstanding Voltage: 1500V
 Insulation Resistance: 1000 Megohms min.

Mechanical

Contact Retention to Housing: 17.79N (4 lb)
 Durability: Tin—25 cycles; Gold—50 cycles

Physical

Housing: Black high-temperature thermal plastic, UL 94V-0
 Contact: Copper Alloy
 Plating: See Table

2.54mm (.100") Pitch C-Grid® Shrouded Header

70568 Dual Row, High-Temperature Through Hole with Pegs Vertical

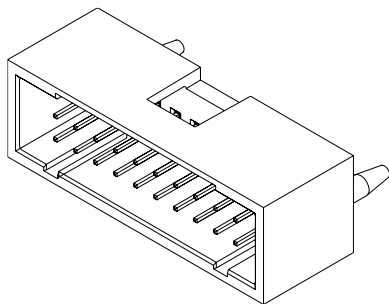

Plating Option	Order No.	Lead-free
	15µ" min. select Gold	
30µ" min. select Gold	15-47-77XX	Yes
150µ" Tin/Lead	15-47-75XX	
Replace XX with no. of circuits, 06-72 (even only)		

Features and Benefits

- Sizes 6 to 72 circuits
- Robotically insertable and compatible
- Board retention pegs hold header in place until they are permanently secured by soldering
- Latch window retains modular connector assemblies after mating
- Standoffs minimize flux retention
- Drawn .025" square wire provides 4-sided smooth surface for quality interface

Reference Information

Product Specification: PS-70567
 Packaging: Tube
 Mates With: C-Grid Receptacles, 70013B interim clip and 70450A crimp housing
 Designed In: Inches

Electrical

Voltage: 250V
 Current: 3.0A
 Contact Resistance: 15 milliohms max.
 Dielectric Withstanding Voltage: 1500V
 Insulation Resistance: 1000 Megohms min.

Mechanical

Contact Retention to Housing: 17.79N (4 lb)
 Durability: Tin—25 cycles; Gold—50 cycles

Physical

Housing: Black high-temperature thermal plastic, UL 94V-0
 Contact: Copper Alloy
 Plating: See Table

2.54 (.100") Pitch C-Grid® Shrouded Header

71349

Dual Row, SMT

Vertical, With and Without Pegs

D

2.54mm (.100") Pitch PCB and Wire Connectors

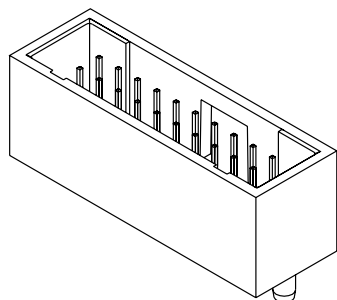

Features and Benefits

- Fully shrouded to protect pins during mating/unmating
- Polarizing slots guide front ribs of mating connector to prevent pin damage
- Latch window retains positive lock after mating
- Press-fit peg provides additional retention to PCB during soldering

Reference Information

Product Specification: PS-71349-001
 Packaging Type: Tube or tape and reel
 Mates with: C-Grid Receptacles, 70013 Version B interim clip and 70450A crimp housing
 Designed in: Inches

Electrical

Electrical Voltage: 250V
 Current: 3.0A
 Contact Resistance: 15 milliohms max.
 Dielectric Withstanding Voltage: 1500V
 Insulation Resistance: 1000 Megohms min.

Mechanical

Contact Retention to Housing: 17.79N (4 lb.)
 Durability: Tin—25 cycles; Gold—50 cycles

Physical

Physical Housing: Black high-temperature thermal plastic, UL 94V-0
 Contact: Copper Alloy
 Plating: See Table

Circuits	Order No.			Lead-free
	150µ" Tin	15µ" Gold	30µ" Gold	
6	71349-X001	71349-X035	71349-X069	Yes
8	71349-X002	71349-X036	71349-X070	
10	71349-X003	71349-X037	71349-X071	
12	71349-X004	71349-X038	71349-X072	
14	71349-X005	71349-X039	71349-X073	
16	71349-X006	71349-X040	71349-X074	
18	71349-X007	71349-X041	71349-X075	
20	71349-X008	71349-X042	71349-X076	
22	71349-X009	71349-X043	71349-X077	
24	71349-X010	71349-X044	71349-X078	
26	71349-X011	71349-X045	71349-X079	
28	71349-X012	71349-X046	71349-X080	
30	71349-X013	71349-X047	71349-X081	
32	71349-X014	71349-X048	71349-X082	
34	71349-X015	71349-X049	71349-X083	
36	71349-X016	71349-X050	71349-X084	
38	71349-X017	71349-X051	71349-X085	
40	71349-X018	71349-X052	71349-X086	

Circuits	Order No.			Lead-free
	150µ" Tin	15µ" Gold	30µ" Gold	
42	71349-X019	71349-X053	71349-X087	Yes
44	71349-X020	71349-X054	71349-X088	
46	71349-X021	71349-X055	71349-X089	
48	71349-X022	71349-X056	71349-X090	
50	71349-X023	71349-X057	71349-X091	
52	71349-X024	71349-X058	71349-X092	
54	71349-X025	71349-X059	71349-X093	
56	71349-X026	71349-X060	71349-X094	
58	71349-X027	71349-X061	71349-X095	
60	71349-X028	71349-X062	71349-X096	
62	71349-X029	71349-X063	71349-X097	
64	71349-X030	71349-X064	71349-X098	
66	71349-X031	71349-X065	71349-X099	
68	71349-X032	71349-X066	71349-X100	
70	71349-X033	71349-X067	71349-X101	
72	71349-X034	71349-X068	71349-X102	

Replace X with 1 for no peg version, 2 for peg version

2.54mm (.100") Pitch C-Grid® Shrouded Header

70229

**Dual Row, Right Angle
With Retention Pegs**

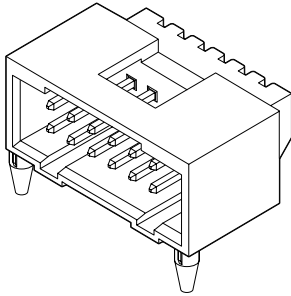

Features and Benefits

- Sizes 6 to 72 circuits
- Board retention pegs hold header in place until they are permanently secured by soldering
- Latch window retains positive lock on 70013 after mating

Reference Information

Product Specification: PS-70229-001
 Packaging: Tube
 UL File No.: E29179
 Mates With: C-Grid Receptacles, 70013 version B interim clip and 70450A crimp housing
 Designed In: Inches

Electrical

Voltage: 250V
 Current: 3.0A
 Contact Resistance: 15 milliohms max.
 Dielectric Withstanding Voltage: 1500V
 Insulation Resistance: 1000 Megohms min.

Mechanical

Pin Retention to Housing: 17.79N (4 lb)
 Durability: Tin—25 cycles; Gold—50 cycles

Physical

Housing: Black polyester, UL 94V-0
 Contact: Copper Alloy
 Plating: See Table

Not For Use With C-Grid III™ Components

Circuits	Order No.		Lead-free
	150µm Tin	15µm Gold	
6	15-47-1061	15-47-6061	Yes
8	15-47-1081	15-47-6081	
10	15-47-1101	15-47-6101	
12	15-47-1121	15-47-6121	
14	15-47-1141	15-47-6141	
16	15-47-1161	15-47-6161	
18	15-47-1181	15-47-6181	
20	15-47-1201	15-47-6201	
22	15-47-1221	15-47-6221	
24	15-47-1241	15-47-6241	
26	15-47-1261	15-47-6261	
28	15-47-1281	15-47-6281	

Circuits	Order No.		Lead-free
	150µm Tin	15µm Gold	
30	15-47-1301	15-47-6301	Yes
32	15-47-1321	15-47-6321	
34	15-47-1341	15-47-6341	
36	15-47-1361	15-47-6361	
38	15-47-1381	15-47-6381	
40	15-47-1401	15-47-6401	
42	15-47-1421	15-47-6421	
44	15-47-1441	15-47-6441	
46	15-47-1461	15-47-6461	
48	15-47-1481	15-47-6481	
50	15-47-1501	15-47-6501	
52	15-47-1521	15-47-6521	

Circuits	Order No.		Lead-free
	150µm Tin	15µm Gold	
54	15-47-1541	15-47-6541	Yes
56	15-47-1561	15-47-6561	
58	15-47-1581	15-47-6581	
60	15-47-1601	15-47-6601	
62	15-47-1621	15-47-6621	
64	15-47-1641	15-47-6641	
66	15-47-1661	15-47-6661	
68	15-47-1681	15-47-6681	
70	15-47-1701	15-47-6701	
72	15-47-1721	15-47-6721	

2.54mm (.100") Pitch C-Grid® Shrouded Header

70204

**Dual Row
With PC Slot and Guide Ears**

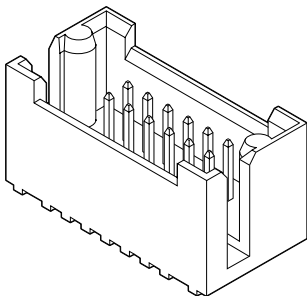

Features and Benefits

- With PC slot and guide ears for blind-mate applications
- Polarization slots and guide ears assure error free mating
- Drawn .025" square wire provides 4-sided smooth surface for quality interface

Reference Information

Product Specification: PS-70204
 Packaging: Tray
 UL File No.: E29179
 CSA File No.: LR19980
 Mates With: 71973 with flange
 Designed In: Inches

Electrical

Voltage: 250V
 Current: 3.0A
 Contact Resistance: 15 milliohms max.
 Dielectric Withstanding Voltage: 1500V
 Insulation Resistance: 1000 Megohms min.

Mechanical

Contact Retention to Housing: 17.79N (4 lb)
 Durability: Tin—25 cycles; Gold—50 cycles

Physical

Housing: Black nylon, UL 94V-0
 Contact: Copper Alloy
 Plating: See Table

Not For Use With C-Grid III™ Components

Plating Options	Order No.	Lead-free
150µm Tin	25-02-20XX	Yes
15µm Gold	25-02-60XX	
30µm Gold	25-02-10XX	

Replace XX with no. of circuits, 08-72 (even only)
 Example: 20 circuit = 25-02-6020

2.54mm (.100") Pitch C-Grid® Shrouded Header

75100 Dual Row With PC Slot and Guide Ears, CPI

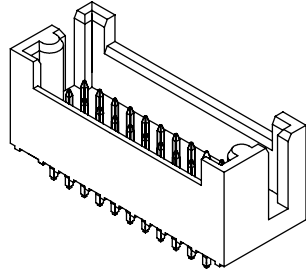

Features and Benefits

- Size 4 to 72 circuits
- With PC slot and guide ears for blind-mate applications
- Polarization slots and guide ears assure error-free mating
- Eye-of-the-needle compliant pin for press-fit applications

Reference Information

Product Specification: PS-75100-001
 Packaging: Tray
 UL File No.: E29179
 CSA File No.: LR19980
 Mates with: 71973 with flange
 Designed In: Inches

Electrical

Voltage: 250V
 Current: 3.0A
 Contact Resistance: 10 milliohms max.
 Dielectric Withstanding Voltage: 1500V
 Insulation Resistance: 1000 Megohms min.

Mechanical

Durability: Tin—25 cycles; Gold—50 cycles

Physical

Housing: Black nylon, UL 94V-0
 Contact: Copper Alloy
 Plating: See table

Circuit Size	Tin	15µ" Gold	30µ" Gold	Lead-free
4	75100-0129	75100-0065	75100-0001	Yes
6	75100-0130	75100-0066	75100-0002	
8	75100-0131	75100-0067	75100-0003	
10	75100-0132	75100-0068	75100-0004	
12	75100-0133	75100-0069	75100-0005	
14	75100-0134	75100-0070	75100-0006	
16	75100-0135	75100-0071	75100-0007	
18	75100-0136	75100-0072	75100-0008	
20	75100-0137	75100-0073	75100-0009	
22	75100-0138	75100-0074	75100-0010	
24	75100-0139	75100-0075	75100-0011	
26	75100-0140	75100-0076	75100-0012	
28	75100-0141	75100-0077	75100-0013	
30	75100-0142	75100-0078	75100-0014	
32	75100-0143	75100-0079	75100-0015	
34	75100-0144	75100-0080	75100-0016	
36	75100-0145	75100-0081	75100-0017	
38	75100-0146	75100-0082	75100-0018	
40	75100-0147	75100-0083	75100-0019	
42	75100-0148	75100-0084	75100-0020	
44	75100-0149	75100-0085	75100-0021	
46	75100-0150	75100-0086	75100-0022	
48	75100-0151	75100-0087	75100-0023	
50	75100-0152	75100-0088	75100-0024	
52	75100-0153	75100-0089	75100-0025	
54	75100-0154	75100-0090	75100-0026	
56	75100-0155	75100-0091	75100-0027	
58	75100-0156	75100-0092	75100-0028	
60	75100-0157	75100-0093	75100-0029	
62	75100-0158	75100-0094	75100-0030	
64	75100-0159	75100-0095	75100-0031	
66	75100-0160	75100-0096	75100-0032	
68	75100-0161	75100-0097	75100-0033	
70	75100-0162	75100-0098	75100-0034	
72	75100-0163	75100-0099	75100-0035	

2.54mm (.100") Pitch C-Grid® Shrouded Header

87834

Dual Row, Low Profile, Vertical

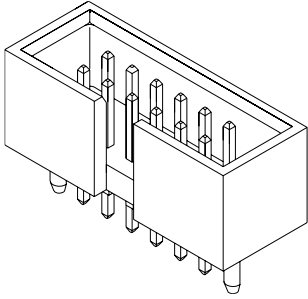

Features and Benefits

- Sizes 4 to 72 circuits
- Low profile
- Polarized slot
- Fully shrouded to protect pins during mating
- In-line or alternate polarization pegs options

Reference Information

Product Specification: PS-70246-100
Mates With: .050" pitch ribbon cable connectors
Designed In: Inches

Electrical

Voltage: 250V AC max.
Current: 2.5A
Dielectric Withstanding Voltage: 600V AC/1 min.
Insulation Resistance: 12,000 Megohms min.

Mechanical

Contact Retention: 0.907kg (2 lb) min.
Pin Push-Out Force: 0.907kg (2 lb) min.

Physical

Housing: Beige glass-filled 4/6 nylon, UL 94V-0
Contact: Copper Alloy
Plating: Gold on contacts and Tin on solder tails

Circuits	Order No.	Lead-free
4	87834-0411	Yes
6	87834-0611	
8	87834-0811	
10	87834-1011	
12	87834-1211	
14	87834-1411	
16	87834-1611	
18	87834-1811	
20	87834-2011	
24	87834-2411	

Circuits	Order No.	Lead-free
26	87834-2611	Yes
30	87834-3011	
34	87834-3411	
40	87834-4011	
44	87834-4411	
50	87834-5011	
56	87834-5611	
60	87834-6011	
64	87834-6411	
72	87834-7211	

2.54mm (.100") Pitch C-Grid® Shrouded Header

70246

Dual Row, Low Profile, Vertical

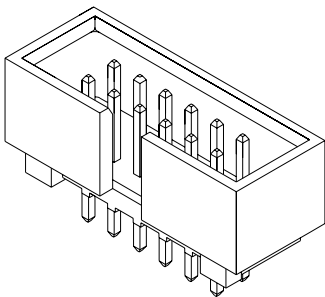

Features and Benefits

- Sizes 8 to 72 circuits
- Polarized slot
- Low profile
- High temperature material version available, contact Molex

Reference Information

Product Specification: PS-70246-100
UL File No.: E29179 (H)
CSA File No.: LR19980A
Mates With: .050" pitch ribbon cable connectors
Designed In: Inches

Electrical

Voltage: 250V
Current: 2.5A DC min.
Contact Resistance: 15 milliohms max.
Dielectric Withstanding Voltage: 1500V
Insulation Resistance: 1000 Megohms min.

Mechanical

Contact Retention to Housing: 17.79N (4 lb)
Durability: 50 cycles Gold

Physical

Housing: Black PBT, UL 94V-0
Contact: Phosphor Bronze
Plating: See Table

Not For Use With C-Grid III™ Components

Circuits	Order No.		Lead-free
	15µm Gold	30µm Gold	
8	70246-0801	70246-0802	Yes
10	70246-1001	70246-1002	
12	70246-1201	70246-1202	
14	70246-1401	70246-1402	
16	70246-1601	70246-1602	
20	70246-2001	70246-2002	
24	70246-2401	70246-2402	
26	70246-2601	70246-2602	

Circuits	Order No.		Lead-free
	15µm Gold	30µm Gold	
30	70246-3001	70246-3002	Yes
34	70246-3401	70246-3402	
40	70246-4001	70246-4002	
44	70246-4401	70246-4402	
50	70246-5001	70246-5002	
56	70246-5601	70246-5602	
60	70246-6001	70246-6002	
64	70246-6401	70246-6402	
72	70246-7201	70246-7202	

2.54mm (.100") Pitch C-Grid® Shrouded Header

70247

**Dual Row, Low Profile
Right Angle**

D

2.54mm (.100") Pitch PCB and Wire Connectors

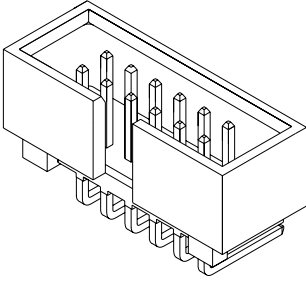

Features and Benefits

- Sizes 8 to 64 circuits
- Polarized slot
- Low profile
- High temperature material version available, contact Molex

Reference Information

Product Specification: PS-70246-100

UL File No.: E29179 (H)

CSA File No.: LR19980A

Mates With: .050" pitch ribbon cable connectors

Designed In: Inches

Electrical

Voltage: 250V

Current: 2.5A DC min.

Contact Resistance: 15 milliohms max.

Dielectric Withstanding Voltage: 600V

Insulation Resistance: 1000 Megohms min.

Mechanical

Contact Retention to Housing: 1.8kg (4 lb)

Durability: 50 cycles Gold

Physical

Housing: Black glass-filled PBT, UL 94V-0

Contact: Phosphor Bronze

Plating: See Table

Not For Use With C-Grid III™ Components

Circuits	Order No.		Lead-fee
	15µm Gold	30µm Gold	
8	70247-0851	70247-0852	Yes
10	70247-1051	70247-1052	
12	70247-1251	70247-1252	
14	70247-1451	70247-1452	
16	70247-1651	70247-1652	
20	70247-2051	70247-2052	
24	70247-2451	70247-2452	
26	70247-2651	70247-2652	
30	70247-3051	70247-3052	

Circuits	Order No.		Lead-fee
	15µm Gold	30µm Gold	
34	70247-3451	70247-3452	Yes
40	70247-4051	70247-4052	
44	70247-4451	70247-4452	
48	70247-4851	70247-4852	
50	70247-5051	70247-5052	
56	70247-5651	70247-5652	
60	70247-6051	70247-6052	
64	70247-6451	70247-6452	
72	70247-7251	70247-7252	

2.54mm (.100") Pitch C-Grid® PC Board Connectors

90147 Single Row Vertical

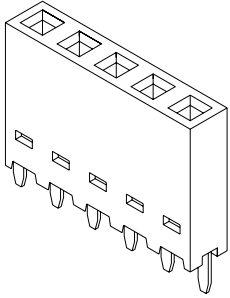

Features and Benefits

- Sizes 2 to 32 circuits
- Contact and plating orientation according to DIN 41651
- Stackable in 2 directions
- Meets HE 13/14 specification
- Suitable for single row headers

Reference Information

Product Specification: PS-99020-0001

Packaging: Tube

UL File No.: E29179

CSA File No.: LR19980

Mates With: 0.64mm (.025") square pins

Use With: 1.57mm (.062") thick PC boards

Designed In: Inches

Electrical

Voltage: 350V

Current: 3.0A

Contact Resistance: 20 milliohms max.

Insulation Resistance: 1000 Megohms min.

Mechanical

Contact Retention to Housing: 15N min.

Mating Force: 1N Gold max. and 3N Tin max.

Unmating Force: 0.2N Gold min. and 0.2N Tin min.

Normal Force: 1N

Physical

Housing: Black glass-filled polyester, UL 94V-0

Contact: Copper Alloy

Plating: See Table

Recommended Mating Pin Length:

5.65mm (.222") min. to 7.00mm (.275") max.

Circuits	Order No.				Lead-free
	Straight Tail				
	Plating A	Plating E	Plating F	Plating N	
2	90147-1102	90147-1202	90147-1302	90147-1402	Yes
3	90147-1103	90147-1203	90147-1303	90147-1403	
4	90147-1104	90147-1204	90147-1304	90147-1404	
5	90147-1105	90147-1205	90147-1305	90147-1405	
6	90147-1106	90147-1206	90147-1306	90147-1406	
7	90147-1107	90147-1207	90147-1307	90147-1407	
8	90147-1108	90147-1208	90147-1308	90147-1408	
9	90147-1109	90147-1209	90147-1309	90147-1409	
10	90147-1110	90147-1210	90147-1310	90147-1410	
11	90147-1111	90147-1211	90147-1311	90147-1411	
12	90147-1112	90147-1212	90147-1312	90147-1412	
14	90147-1114	90147-1214	90147-1314	90147-1414	
18	90147-1118	90147-1218	90147-1318	90147-1418	
25	90147-1125	90147-1225	90147-1325	90147-1425	
30	90147-1130	90147-1230	90147-1330	90147-1430	
32	90147-1132	90147-1232	90147-1332	90147-1432	

For other available circuit sizes contact Molex

Plating A: 1.00µm (39µ") min. Hot Tin dip

Plating E: 0.38mm (15µ") selective Gold over Nickel and 4µm (160µ") Tin over Nickel

Plating F: 0.76mm (30µ") to 1.00mm (40µ") selective Gold over Nickel and 4µm (160µ") Tin over Nickel

Plating N: 0.76mm (30µ") to 2.6mm (100µ") selective Gold over Nickel and 4µm (160µ") Tin over Nickel

2.54mm (.100") Pitch C-Grid® PC Board Connectors

90148 Single Row Horizontal

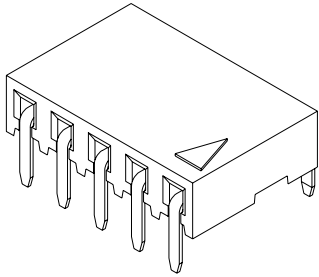

Features and Benefits

- Sizes 2 to 32 circuits
- Contact and plating orientation according to DIN 41651
- Stackable end-to-end
- Meets HE 13/14 specification
- Suitable for single row headers

Reference Information

Product Specification: PS-99020-0001
 Packaging: Tube
 UL File No.: E29179
 CSA File No.: LR19980
 Mates With: 0.64 (.025") square pins
 Use With: 1.57mm (.062") thick PC boards
 Designed In: Inches

Electrical

Voltage: 350V
 Current: 3.0A
 Contact Resistance: 20 milliohms max.
 Insulation Resistance: 1000 Megohms min.

Mechanical

Contact Retention to Housing: 15N min.
 Mating Force: 1N Gold max. and 3N Tin max.
 Unmating Force: 0.2N Gold min. and 0.2N Tin min.
 Normal Force: 1N

Physical

Housing: Black glass-filled polyester, UL 94V-0
 Contact: Copper Alloy
 Plating: See Table
 Recommended Mating Pin Length:
 5.65mm (.222") min. to 7.00mm (.275") max.

Circuits	Order No.			Lead-free
	Straight Tail			
	Plating A	Plating E	Plating F	
2	90148-1102	90148-1202	90148-1302	Yes
4	90148-1104	90148-1204	90148-1304	
6	90148-1106	90148-1206	90148-1306	
8	90148-1108	90148-1208	90148-1308	
10	90148-1110	90148-1210	90148-1310	

Circuits	Order No.			Lead-free
	Straight Tail			
	Plating A	Plating E	Plating F	
12	90148-1112	90148-1212	90148-1312	Yes
14	90148-1114	90148-1214	90148-1314	
18	90148-1118	90148-1218	90148-1318	
30	90148-1130	90148-1230	90148-1330	
32	90148-1132	90148-1232	90148-1332	

For other available circuit sizes contact Molex
 Plating A: 1.00mm (39μ") min. Hot Tin dip
 Plating E: 0.38mm (15μ") selective Gold over Nickel and 4mm (160μ") Tin over Nickel
 Plating F: 0.76mm (30μ") selective Gold over Nickel and 4mm (160μ") Tin over Nickel

2.54mm (.100") Pitch C-Grid® Receptacle

71850 High Profile, Dual Row High-Temperature, Vertical Through Hole

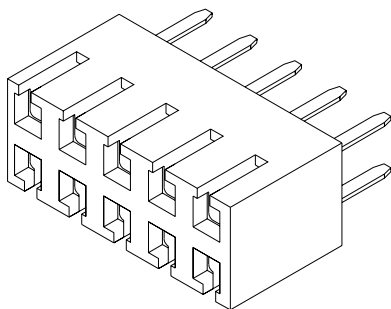

Features and Benefits

- Sizes 4 to 80 circuits
- Available with or without retention pegs
- High profile: .340" high
- Designed for parallel and perpendicular board stacking
- Stackable end-to-end on .100" grid

Reference Information

Product Specification: PS-70181
 Packaging: Tray
 UL File No.: E29179
 CSA File No.: LR19980
 Mates With: C-Grid breakaway and shrouded headers
 Designed In: Inches

Electrical

Voltage: 250V
 Current: 2.5A
 Contact Resistance: 15 milliohms max.
 Dielectric Withstanding Voltage: 1500V
 Insulation Resistance: 1000 Megohms min.

Mechanical

Contact Insertion Force: 182g (0.4 lb)
 Insertion Force to PCB: 3.6kg (8 lb) per peg
 Durability: Tin—25 cycles; Gold—50 cycles

Physical

Housing: Black high-temperature thermal plastic, UL 94V-0
 Contact: Copper Alloy
 Plating: See Table

Plating Option	Order No.	Lead-free
150μ" Tin	15-44-68XX	Yes
15μ" Gold	15-44-58XX	
30μ" Gold	15-44-51XX	
Replace XX with no. of circuits, 04-80 (even only) Example: 20 circuit = 15-44-5820		

2.54mm (.100") Pitch C-Grid® PCB Connector

71395

**High Profile, Dual Row
Vertical, SMT**

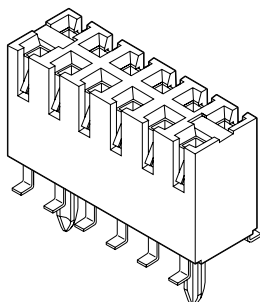

Features and Benefits

- Available with or without retention pegs
- Gull wing surface mount tails
- High profile: .340" high
- Designed for parallel and perpendicular board stacking
- Stackable end-to-end on .100" grid

Reference Information

Product Specification: PS-71395
Packaging: Tray
UL File No.: E29179
Mates With: C-Grid breakaway and shrouded headers
Designed In: Inches

Electrical

Voltage: 250V
Current: 2.5A
Contact Resistance: 15 milliohms max.
Dielectric Withstanding Voltage: 1500V
Insulation Resistance: 1000 Megohms min.

Mechanical

Insertion Force to PCB: 3.6kg (8 lb) per peg
Durability: Tin—25 cycles; Gold—50 cycles

Physical

Housing: Black high-temperature thermal plastic, UL 94V-0
Contact: Copper Alloy
Plating: See Table
Screened Paste Thickness: .010 to .015"

Not For Use With Molex C-Grid III™ Components

Plating Option	Order No.		Lead-free
	With PCB Retention Pegs	Without Pegs	
150µ" min. Tin	15-45-34XX	15-45-32XX	Yes
15µ" Gold	15-45-35XX	15-45-31XX	
30µ" min. Gold	15-45-36XX	15-45-33XX	
Replace XX with no. of circuits, 08-80 (even only) Example: 20 circuit = 15-45-3520			

2.54mm (.100") Pitch C-Grid® Receptacle

71979

**Dual Row, Right Angle
SMT**

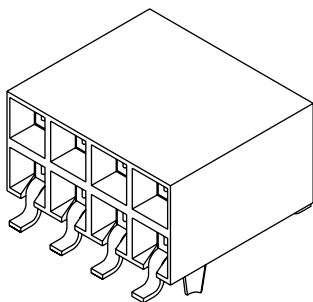

Features and Benefits

- Designed for perpendicular board stacking
- Dual beam box contact
- Staggered mating depth to lower initial insertion force
- Positive pin stop to prevent shorting between rows
- Available without pegs

Reference Information

Product Specification: PS-71973
Packaging: Tube
UL File No.: E29179
Mates With: C-Grid breakaway headers
Designed In: Inches

Electrical

Voltage: 250V
Current: 2.0A
Contact Resistance: 15 milliohms max.
Dielectric Withstanding Voltage: 1500V
Insulation Resistance: 1000 Megohms min

Mechanical

Mating Force: 1.33N (0.3 lb)
Durability: 50 cycles

Physical

Housing: Black high-temperature thermal plastic, UL 94V-0
Contact: Copper Alloy
Plating: See Table

Not For Use With Molex C-Grid III™ Components

Plating Options	Order No.	Lead-free
15µ" Gold	71979-02XX	Yes
30µ" Gold	71979-03XX	
50µ" Gold	71979-04XX	
Replace XX with no. of circuits per row, 08-80 Example: 20 circuit = 71979-0220		

2.54mm (.100") Pitch C-Grid® PCB Connector

71973

**Dual Row, Right Angle
Early Entry Receptacle
Flangeless**

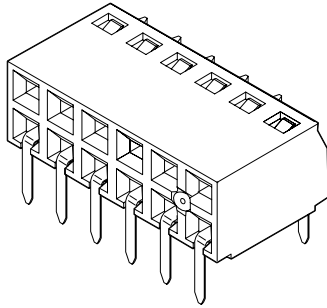

Features and Benefits

- Early entry contact provides .040" additional gold wipe on male post
- Designed for perpendicular board stacking
- Stackable end-to-end
- Flangeless with lower row pin stop offered, contact Molex
- Closed bottom insulator to prevent solder wicking

Reference Information

Product Specification: PS-71973
Packaging: Tube
UL File No.: E29179
Mates With: C-Grid breakaway headers
Designed In: Inches

Electrical

Voltage: 250V
Current: 2.0A
Contact Resistance: 15 milliohms max.
Dielectric Withstanding Voltage: 1500V
Insulation Resistance: 1000 Megohms min.

Mechanical

Mating Force: 1.33N (0.3 lb)
Durability: 50 cycles

Physical

Housing: Black high-temperature thermal plastic, UL 94V-0
Contact: Copper Alloy
Plating: See Table

Not For Use With Molex C-Grid III™ Components

Plating Options	Order No.	Lead-free
15µm Gold	71973-02XX	Yes
30µm Gold	71973-03XX	
50µm Gold	71973-04XX	
Replace XX with no. of circuits per row, 04-40 Example: 20 circuit = 71973-0220		

2.54mm (.100") Pitch C-Grid® PCB Connector

71973

**Dual Row, Right Angle
Early Entry Receptacle
With Flange**

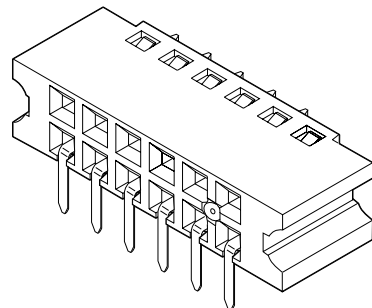

Features and Benefits

- Early entry contact provides .040" additional gold wipe on male post
- Designed for perpendicular board stacking
- Lower row pin stop offered, contact Molex
- Closed bottom insulator to prevent solder wicking
- Flange slides over guide ears on header for blind mate applications

Reference Information

Product Specification: PS-71973
Packaging: Tube
UL File No.: E29179
Mates With: 70204
Designed In: Inches

Electrical

Voltage: 250V
Current: 2.0A
Contact Resistance: 15 milliohms max.
Dielectric Withstanding Voltage: 1500V
Insulation Resistance: 1000 Megohms min.

Mechanical

Mating Force: 1.33N (0.3 lb)
Durability: 50 cycles

Physical

Housing: Black high-temperature thermal plastic, UL 94V-0
Contact: Copper Alloy
Plating: See Table

Not For Use With Molex C-Grid III™ Components

Plating Options	Order No.	Lead-free
15µm Gold	71973-10XX	Yes
30µm Gold	71973-11XX	
50µm Gold	71973-12XX	
Replace XX with no. of circuits per row, 04-36 Example: 20 circuit = 71973-1220		

2.54mm (.100") Pitch C-Grid® Shunt/Jumper

7859
2-Circuit

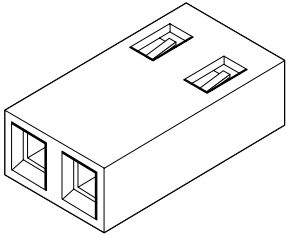

Features and Benefits

- Easily applied without soldering and reliable without accidental disconnects
- Low cost alternative to DIP switches
- Increases current flow and decreases resistance vs DIP switches
- Dual beam terminals: 2 points of contact per pin
- Open and closed top versions
- Stackable end-to-end and side-to-side

Reference Information

Product Specification: PS-7859
Packaging: Bag
UL File No.: E29179
CSA File No.: LR19980
Mates With: C-Grid breakaway headers
Designed In: Inches

Electrical

Voltage: 250V
Current: 5.0A
Contact Resistance: 30 milliohms max.
Dielectric Withstanding Voltage: 1500V
Insulation Resistance: 100K Megohms min.

Mechanical

Contact Retention to Housing: 26.69N (4 lb)
Mating Force: 4.448N (6 lb)
Unmating Force: 0.98N (1 lb)
Durability: Tin—25 cycles; Gold—200 cycles

Physical

Housing: Black polyester, UL 94V-0
Contact: Copper Alloy
Plating: See Table

Not For Use With Molex C-Grid III™ Components

Open Top		
Order No.	Plating	Lead-free
15-38-1024	150µ" Tin	Yes
15-29-1024	15µ" Gold	
15-29-1026	30µ" Gold	

Closed Top		
Order No.	Plating	Lead-free
15-38-1026	150µ" Tin	Yes
15-29-1025	15µ" Gold	
15-29-1027	30µ" Gold	

2.54mm (.100") Pitch C-Grid® Micro Shunt

90059

Low Profile

Features and Benefits

- Fully stackable
- Center probe hole—for continuity testing and easy pull-off
- Color-coded housings for plating and identification
- Delivered on break-off carrier strips for easy handling (10 per strip) or loose
- Recommended to be applied after mating header is soldered

Reference Information

Product Specification: PS-90059
Packaging: Strips or Bag
UL File No.: E29179
CSA File No.: LR19980
Designed In: Inches

Electrical

Voltage: 350V
Current: 3.0A Gold; 1.5A Tin
Contact Resistance: Gold—12 milliohms max.;
Tin—15 milliohms max.
Dielectric Withstanding Voltage: 2000V
Insulation Resistance: 2000 Megohms max.

Mechanical

Mating Force: 7N max.
Unmating Force: 0.3N Gold; 0.5N Tin min.
Durability: 50 cycles Gold and 20 cycles Tin

Physical

Housing: Glass-filled polyester, UL 94V-0
Contact: Phosphor Bronze
Plating: See Table
Height: 4.95mm (.195") max.

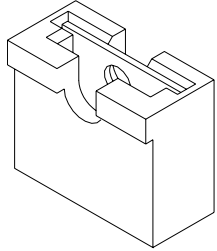

D 2.54mm (.100") Pitch PCB and Wire Connectors

Order No.	Plating No.	Color	Packaging	Lead-free
90059-0009*	1	White	Strip	Yes
90059-0007*	2	Black		
90059-0013	3			
90059-0014	4	White		
90059-0012	5			
90059-1009	1	White	Bag	
90059-1007	2	Black		

* Preferred Version In Europe/Americas

Plating No. 1: 0.38µm (15µ") Gold in contact area over 0.76µm (30µ") Nickel with Gold flash overall

Plating No. 2: 5.0µm (200µ") min. Tin over 0.2µm (8µ") min. Copper

Plating No. 3: 0.9µm (35µ") min. Prefinished

Plating No. 4: 0.1µm (4µ") min. Gold over 1.0µm (40µ") min. Nickel overall

Plating No. 5: 0.76µm (30µ") Gold over 1.27µm (50µ") Nickel in contact area with 0.2mm (8µ") min. Nickel overall

www.molex.com/product/cgrid/cgrid.html

2.54mm (.100") Pitch C-Grid III™

The C-Grid III 2.54mm (.100") pitch post and receptacle interconnection system offers complete design flexibility and modular components that provide the widest range of electronic packaging alternatives. C-Grid III is a highly-versatile 2.54mm interconnection system offering unique design features:

Surface Treatment

C-Grid III is available in 3 standard platings. Two performance levels of selective Gold and one of Tin, all over a Nickel-plated substrate, guarantee the optimum ration of quality versus cost for your application.

Flexibility

C-Grid III has been developed to meet the latest industry requirements. Two different termination techniques, solder tail, crimp and insulation displacement, are combined in a complete interconnection system which is based on north/south contact orientation. Headers will accept both discrete wire and ribbon cable connectors.

Advantage by Design

C-Grid III box contact design employs the same mating concept with all termination techniques. A uniform locking system on all contacts allows full interchangeability inside different housing styles.

Interchangeability

C-Grid III is fully compatible with the industry standard DIN 41651 as well as the French norm HE-13/14. Moreover, it is fully intermateable/interchangeable with Molex's QF-50 product range.

Lower Applied Cost

C-Grid III system incorporates a wide range of advanced application tooling, from manually-operated hand tools to semi-automatic harness making machines.

C-Grid III offers the widest range of interconnection packaging alternatives in the electronic market today.

D

2.54mm (.100") Pitch PCB and Wire Connectors

Not For Use With Molex SL™ Components

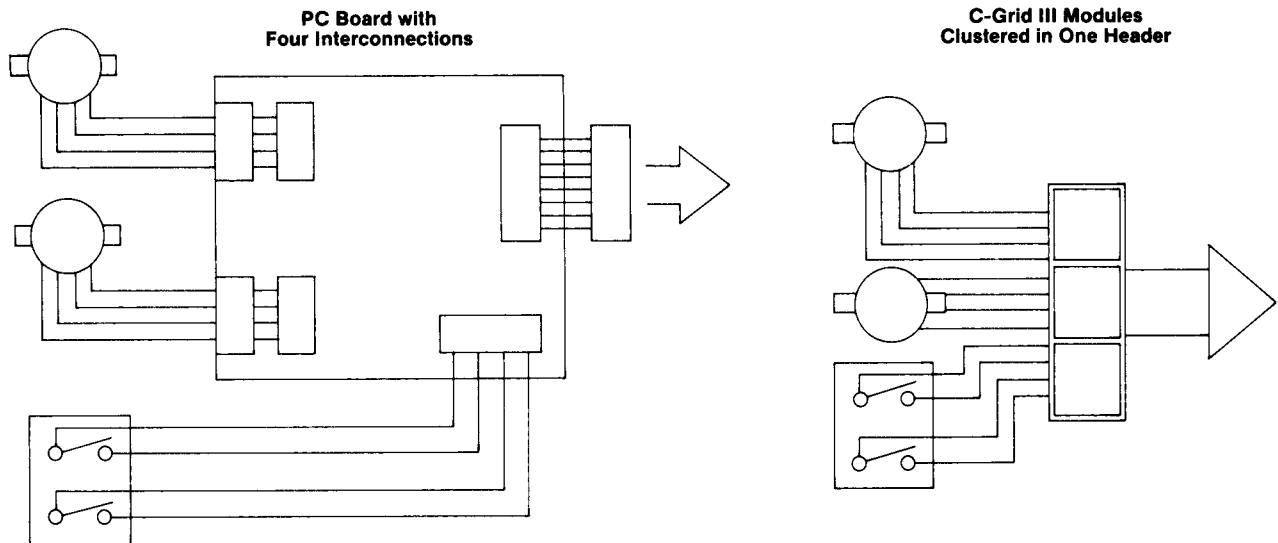

2.54mm (.100") Pitch C-Grid III™ Terminal

90119
Female
Crimp

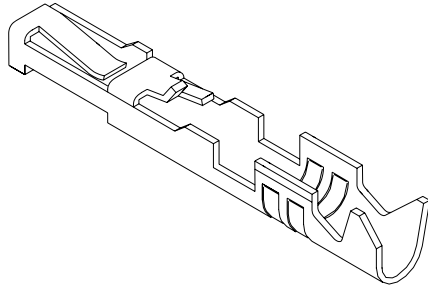

Features and Benefits

- Fully enclosed contact box
- Contact and plating orientation according to DIN 41651
- North/south contact orientation avoids overstress

Reference Information

Product Specification: PS-99020-0001
 Packaging: Chain or bag
 Mates With: 0.64mm (.025") square pins
 Use With: 90123, 90142, 90143, 90156 and 90160
 Designed In: Inches

Electrical

Voltage: 350V
 Current: 3.0A
 Contact Resistance: 20 milliohms max.

Mechanical

Contact Retention to Housing: 15N (1.5kgf)
 Normal Force: 1N

Physical

Contact: Copper Alloy
 Plating: See Table
 Wire Range: 22 to 24 and 26 to 28 AWG
 Wire Insulation Diameter: 1.70mm (.067") max.

Plating A: 1.00µm (39µ") min. Hot Tin dip
 Plating E: 0.38µm (15µ") selective Gold over Nickel and 4µm (160µ") Tin over Nickel
 Plating F: 0.76µm (30µ") selective Gold over Nickel and 4µm (160µ") Tin over Nickel

Not For Use With Molex SL™ Components

Order No.	Plating Option	Packaging	Wire Size (AWG)	Insulation Diameter Range	Lead-free
90119-0109	A	Chain—Left Hand Feed	22-24	1.02/1.47 (.040/.058)	Yes
90119-0110	E				
90119-0111	F				
90119-0120	A		26-28	0.76/1.22 (.030/.048)	
90119-0121	E				
90119-0122	F				
90119-2109	A	Bag	22-24	1.02/1.47 (.040/.058)	
90119-2110	E				
90119-2111	F				
90119-2120	A		26-28	0.76/1.22 (.030/.048)	
90119-2121	E				
90119-2122	F				

For other available versions contact Molex

2.54mm (.100") Pitch C-Grid III™ Crimp Connector Housing

90142
Dual Row

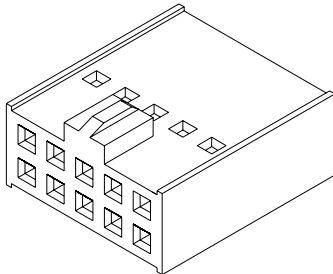

Features and Benefits

- Sizes 6 to 64 circuits
- Polarized
- Friction lock

Reference Information

Product Specification: PS-99020-0001
 Packaging: Bag
 Mates With: 90122, 90130 and 90131
 Use With: 90119
 Designed In: Inches

Electrical

Voltage: 350V
 Current: 3.0A max.
 Contact Resistance: 20 milliohms max.
 Insulation Resistance: 1000 Megohms min.

Mechanical

Contact Retention to Housing: 15N min.
 Normal Force: 1N

Physical

Housing: Black polyphenylene oxide, UL 94V-1

Delivered on a carrier with 20 pieces per strip.

Actual Size **Universal Polarizing Pin 40713-1**
 Order No. 15-04-0292

Not For Use With Molex SL™ Components

Circuits	Order No.	Circuits	Order No.	Circuits	Order No.
6	90142-0006	20	90142-0020	38	90142-0038
8	90142-0008	22	90142-0022	40	90142-0040
10	90142-0010	24	90142-0024	44	90142-0044
12	90142-0012	26	90142-0026	50	90142-0050
14	90142-0014	30	90142-0030	54	90142-0054
16	90142-0016	34	90142-0034	60	90142-0060
18	90142-0018	36	90142-0036	64	90142-0064

For other available circuit sizes contact Molex

2.54mm (.100") Pitch C-Grid III™ Header

90120 Single Row Vertical

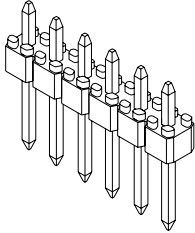

Features and Benefits

- Sizes 2 to 40 circuits
- Easy breakaway to smaller sizes
- Contact and plating orientation according to DIN 41651
- North/south contact orientation avoids overstress
- High pin retention
- High mechanical stability after soldering

Reference Information

Product Specification: PS-99020-0001
Packaging: Bag
Mates With: C-Grid III Housing and Connectors
Designed In: Inches

Electrical

Voltage: 350V
Current: 3.0A
Contact Resistance: 20 milliohms max.
Insulation Resistance: 5000 Megohms min.

Mechanical

Contact Retention to Housing: 20N (2.0kgf) min.
Mating Force: 1N max. Gold and 3N max. Tin
Unmating Force: 0.2N min. Gold and 0.2N min. Tin
Normal Force: 1N

Physical

Housing: Black glass-filled polyester, UL 94V-0
Contact: Copper Alloy, 0.64mm (.025") square pins
Plating: See Table

Plating A: 4 μ m (160 μ in) Tin over Nickel
Plating E: 0.38 μ m (15 μ in) selective Gold over Nickel and 4 μ m (160 μ in) Tin over Nickel
Plating F: 0.76 μ m (30 μ in) selective Gold over Nickel and 4 μ m (160 μ in) Tin over Nickel

Not For Use With Molex SL™ Components

Circuits	Order No.			Lead-free
	Plating A	Plating E	Plating F	
3	90120-0123	90120-0763	90120-0923	Yes
4	90120-0124	90120-0764	90120-0924	
5	90120-0125	90120-0765	90120-0925	
6	90120-0126	90120-0766	90120-0926	
7	90120-0127	90120-0767	90120-0927	
8	90120-0128	90120-0768	90120-0928	
9	90120-0129	90120-0769	90120-0929	
10	90120-0130	90120-0770	90120-0930	
11	90120-0131	90120-0771	90120-0931	
12	90120-0132	90120-0772	90120-0932	
13	90120-0133	90120-0773	90120-0933	
14	90120-0134	90120-0774	90120-0934	
15	90120-0135	90120-0775	90120-0935	
16	90120-0136	90120-0776	90120-0936	
17	90120-0137	90120-0777	90120-0937	
18	90120-0138	90120-0778	90120-0938	
19	90120-0139	90120-0779	90120-0939	
20	90120-0140	90120-0780	90120-0940	
21	90120-0141	90120-0781	90120-0941	

For other available versions contact Molex

Circuits	Order No.			Lead-free
	Plating A	Plating E	Plating F	
22	90120-0142	90120-0782	90120-0942	Yes
23	90120-0143	90120-0783	90120-0943	
24	90120-0144	90120-0784	90120-0944	
25	90120-0145	90120-0785	90120-0945	
26	90120-0146	90120-0786	90120-0946	
27	90120-0147	90120-0787	90120-0947	
28	90120-0148	90120-0788	90120-0948	
29	90120-0149	90120-0789	90120-0949	
30	90120-0150	90120-0790	90120-0950	
31	90120-0151	90120-0791	90120-0951	
32	90120-0152	90120-0792	90120-0952	
33	90120-0153	90120-0793	90120-0953	
34	90120-0154	90120-0794	90120-0954	
35	90120-0155	90120-0795	90120-0955	
36	90120-0156	90120-0796	90120-0956	
37	90120-0157	90120-0797	90120-0957	
38	90120-0158	90120-0798	90120-0958	
39	90120-0159	90120-0799	90120-0959	
40	90120-0160	90120-0800	90120-0960	

D

2.54mm (.100") Pitch PCB and Wire Connectors

2.54mm (.100") Pitch C-Grid III™ Header

90131 Dual Row Vertical

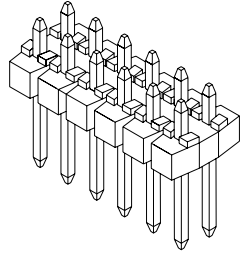

Features and Benefits

- Sizes 4 to 80 circuits
- Easy breakaway to smaller sizes
- Stackable side-to-side
- Contact and plating orientation according to DIN 41651
- North/south contact orientation avoids overstress
- High pin retention and high mechanical stability after soldering

Reference Information

Product Specification: PS-99020-0001
Packaging: Bag
Mates With: C-Grid III Housing and Connectors
Designed In: Inches

Electrical

Voltage: 350V max.
Current: 3.0A
Contact Resistance: 20 milliohms max.
Insulation Resistance: 5000 Megohms min.

Mechanical

Contact Retention to Housing: 20N (2.0kgf) min.
Mating Force: 1N max. Gold and 3N max. Tin
Unmating Force: 0.2N min. Gold and 0.2N min. Tin
Normal Force: 1N

Physical

Housing: Black glass-filled polyester, UL 94V-0
Contact: Copper Alloy, 0.64mm (.025") square pins
Plating: See Table

Plating A: 4µm (160µ") Tin over Nickel
Plating E: 0.38µm (15µ") selective Gold over Nickel and 4µm (160µ") Tin over Nickel
Plating F: 0.76µm (30µ") selective Gold over Nickel and 4µm (160µ") Tin over Nickel

Not For Use With Molex SL™ Components

Circuits	Order No.			Lead-free
	Plating A	Plating E	Plating F	
4	90131-0122	90131-0762	90131-0922	Yes
6	90131-0123	90131-0763	90131-0923	
8	90131-0124	90131-0764	90131-0924	
10	90131-0125	90131-0765	90131-0925	
12	90131-0126	90131-0766	90131-0926	
14	90131-0127	90131-0767	90131-0927	
16	90131-0128	90131-0768	90131-0928	
18	90131-0129	90131-0769	90131-0929	
20	90131-0130	90131-0770	90131-0930	
22	90131-0131	90131-0771	90131-0931	
24	90131-0132	90131-0772	90131-0932	
26	90131-0133	90131-0773	90131-0933	
28	90131-0134	90131-0774	90131-0934	
30	90131-0135	90131-0775	90131-0935	
32	90131-0136	90131-0776	90131-0936	
34	90131-0137	90131-0777	90131-0937	
36	90131-0138	90131-0778	90131-0938	
38	90131-0139	90131-0779	90131-0939	
40	90131-0140	90131-0780	90131-0940	

For other available versions contact Molex

Circuits	Order No.			Lead-free
	Plating A	Plating E	Plating F	
42	90131-0141	90131-0781	90131-0941	Yes
44	90131-0142	90131-0782	90131-0942	
46	90131-0143	90131-0783	90131-0943	
48	90131-0144	90131-0784	90131-0944	
50	90131-0145	90131-0785	90131-0945	
52	90131-0146	90131-0786	90131-0946	
54	90131-0147	90131-0787	90131-0947	
56	90131-0148	90131-0788	90131-0948	
58	90131-0149	90131-0789	90131-0949	
60	90131-0150	90131-0790	90131-0950	
62	90131-0151	90131-0791	90131-0951	
64	90131-0152	90131-0792	90131-0952	
66	90131-0153	90131-0793	90131-0953	
68	90131-0154	90131-0794	90131-0954	
70	90131-0155	90131-0795	90131-0955	
72	90131-0156	90131-0796	90131-0956	
74	90131-0157	90131-0797	90131-0957	
76	90131-0158	90131-0798	90131-0958	
78	90131-0159	90131-0799	90131-0959	

2.54mm (.100") Pitch C-Grid III™ Header

90122 Dual Row Right Angle

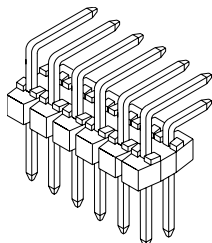

Features and Benefits

- Sizes 4 to 80 circuits
- Easy breakaway to smaller sizes
- Contact and plating orientation according to DIN 41651
- North/south contact orientation avoids overstress
- High pin retention
- High mechanical stability after soldering

Reference Information

Product Specification: PS-99020-0001
Packaging: Bag
Mates With: C-Grid III Housing and Connectors
Designed In: Inches

Electrical

Voltage: 350V
Current: 3.0A
Contact Resistance: 20 milliohms max.
Insulation Resistance: 5000 Megohms min.

Mechanical

Contact Retention to Housing: 20N (2.0kgf) min.
Mating Force: 1N max. Gold and 3N max. Tin
Unmating Force: 0.2N min. Gold and 0.2N min. Tin
Normal Force: 1N

Physical

Housing: Black glass-filled polyester, UL 94V-0
Contact: Copper Alloy, 0.64mm (.025") square pins
Plating: See Table

Plating A: 4µm (160µ") Tin over Nickel
Plating E: 0.38µm (15µ") selective Gold over Nickel and 4µm (160µ") Tin over Nickel
Plating F: 0.76µm (30µ") selective Gold over Nickel and 4µm (160µ") Tin over Nickel

Not For Use With Molex SL™ Components

Circuits	Order No.			Lead-free
	Plating A	Plating E	Plating F	
4	90122-0122	90122-0762	90122-0922	Yes
6	90122-0123	90122-0763	90122-0923	
8	90122-0124	90122-0764	90122-0924	
10	90122-0125	90122-0765	90122-0925	
12	90122-0126	90122-0766	90122-0926	
14	90122-0127	90122-0767	90122-0927	
16	90122-0128	90122-0768	90122-0928	
18	90122-0129	90122-0769	90122-0929	
20	90122-0130	90122-0770	90122-0930	
22	90122-0131	90122-0771	90122-0931	
24	90122-0132	90122-0772	90122-0932	
26	90122-0133	90122-0773	90122-0933	
28	90122-0134	90122-0774	90122-0934	
30	90122-0135	90122-0775	90122-0935	
32	90122-0136	90122-0776	90122-0936	
34	90122-0137	90122-0777	90122-0937	
36	90122-0138	90122-0778	90122-0938	
38	90122-0139	90122-0779	90122-0939	
40	90122-0140	90122-0780	90122-0940	
42	90122-0141	90122-0781	90122-0941	

For other available versions contact Molex

Circuits	Order No.			Lead-free
	Plating A	Plating E	Plating F	
44	90122-0142	90122-0782	90122-0942	Yes
46	90122-0143	90122-0783	90122-0943	
48	90122-0144	90122-0784	90122-0944	
50	90122-0145	90122-0785	90122-0945	
52	90122-0146	90122-0786	90122-0946	
54	90122-0147	90122-0787	90122-0947	
56	90122-0148	90122-0788	90122-0948	
58	90122-0149	90122-0789	90122-0949	
60	90122-0150	90122-0790	90122-0950	
62	90122-0151	90122-0791	90122-0951	
64	90122-0152	90122-0792	90122-0952	
66	90122-0153	90122-0793	90122-0953	
68	90122-0154	90122-0794	90122-0954	
70	90122-0155	90122-0795	90122-0955	
72	90122-0156	90122-0796	90122-0956	
74	90122-0157	90122-0797	90122-0957	
76	90122-0158	90122-0798	90122-0958	
78	90122-0159	90122-0799	90122-0959	
80	90122-0160	90122-0800	90122-0960	

D
2.54mm (.100") Pitch PCB and Wire Connectors

2.54mm (.100") Pitch C-Grid III™ Shrouded Header

90136
Single Row
Vertical

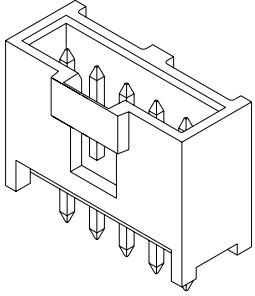

Not For Use With Molex SL™ Components

Circuits	Order No.			Lead-free
	Plating A	Plating E	Plating F	
2	90136-1102	90136-1202	90136-1302	Yes
3	90136-1103	90136-1203	90136-1303	
4	90136-1104	90136-1204	90136-1304	
5	90136-1105	90136-1205	90136-1305	
6	90136-1106	90136-1206	90136-1306	
7	90136-1107	90136-1207	90136-1307	
8	90136-1108	90136-1208	90136-1308	
9	90136-1109	90136-1209	90136-1309	

For other available circuit sizes contact Molex

Features and Benefits

- Sizes 2 to 32 circuits
- Contact and plating orientation according to DIN 41651
- North/south contact orientation avoids overstress
- High pin retention
- Polarized
- Friction lock

Reference Information

Product Specification: PS-99020-0001
Packaging: Tray
Mates With: 90123 and 90156
Designed In: Inches

Electrical

Voltage: 350V
Current: 3.0A
Contact Resistance: 20 milliohms max.
Insulation Resistance: 1000 Megohms min.

Mechanical

Contact Resistance: 20N (2.0kgf) min.
Mating Force: 1N max. Gold and 3N max. Tin
Unmating Force: 0.2N min. Gold and 0.2N min. Tin
Normal Force: 1N

Physical

Housing: Black glass-filled polyester, UL 94V-0
Contact: Copper Alloy, 0.64mm (.025") square pins
Plating: See Table

Plating A: 4µm (160µ") Tin over Nickel
Plating E: 0.38µm (15µ") selective Gold over Nickel and 4µm (160µ") Tin over Nickel
Plating F: 0.76µm (30µ") selective Gold over Nickel and 4µm (160µ") Tin over Nickel

Circuits	Order No.			Lead-free
	Plating A	Plating E	Plating F	
10	90136-1110	90136-1210	90136-1310	Yes
12	90136-1112	90136-1212	90136-1312	
15	90136-1115	90136-1215	90136-1315	
18	90136-1118	90136-1218	90136-1318	
22	90136-1122	90136-1222	90136-1322	
25	90136-1125	90136-1225	90136-1325	
30	90136-1130	90136-1230	90136-1330	
32	90136-1132	90136-1232	90136-1332	

2.54mm (.100") Pitch C-Grid III™ Shrouded Header

90136
Single Row
Right Angle

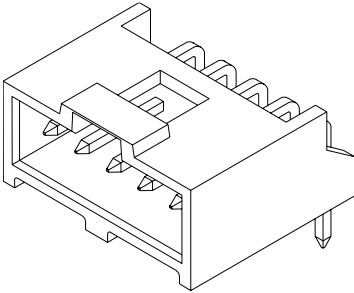

Not For Use With Molex SL™ Components

Circuits	Order No.			Lead-free
	Plating A	Plating E	Plating F	
2	90136-2102	90136-2202	90136-2302	Yes
3	90136-2103	90136-2203	90136-2303	
4	90136-2104	90136-2204	90136-2304	
5	90136-2105	90136-2205	90136-2305	
6	90136-2106	90136-2206	90136-2306	
7	90136-2107	90136-2207	90136-2307	
8	90136-2108	90136-2208	90136-2308	
9	90136-2109	90136-2209	90136-2309	

For other available circuit sizes contact Molex

Features and Benefits

- Sizes 2 to 32 circuits
- Contact and plating orientation according to DIN 41651
- North/south contact orientation avoids overstress
- High pin retention, polarized and friction lock
- 1 through 6 circuits with endwall stabilization features

Reference Information

Product Specification: PS-99020-0001
Packaging: Tray
Mates With: 90123 and 90156
Designed In: Inches

Electrical

Voltage: 350V
Current: 3.0A
Contact Resistance: 20 milliohms max.
Insulation Resistance: 1000 Megohms min.

Mechanical

Contact Retention to Housing: 20N (2.0kgf) min.
Mating Force: 1N Gold and 3N max. Tin
Unmating Force: 0.2N min. Gold and 0.2N min. Tin
Normal Force: 1N

Physical

Housing: Black glass-filled polyester, UL 94V-0
Contact: Copper Alloy, 0.64mm (.025") square pins
Plating: See Table

Plating A: 4µm (160µ") Tin over Nickel
Plating E: 0.38µm (15µ") selective Gold over Nickel and 4µm (160µ") Tin over Nickel
Plating F: 0.76µm (30µ") selective Gold over Nickel and 4µm (160µ") Tin over Nickel

Circuits	Order No.			Lead-free
	Plating A	Plating E	Plating F	
10	90136-2110	90136-2210	90136-2310	Yes
12	90136-2112	90136-2212	90136-2312	
15	90136-2115	90136-2215	90136-2315	
18	90136-2118	90136-2218	90136-2318	
22	90136-2122	90136-2222	90136-2322	
25	90136-2125	90136-2225	90136-2325	
30	90136-2130	90136-2230	90136-2330	
32	90136-2132	90136-2232	90136-2332	

2.54mm (.100") Pitch C-Grid III™ Shrouded Header

90130 Dual Row, Vertical Fully Loaded

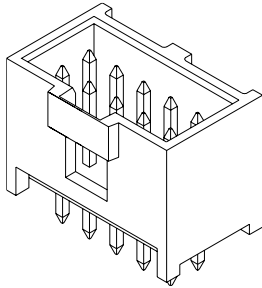

Features and Benefits

- Sizes 6 to 64 circuits
- Contact and plating orientation according to DIN 41651
- North/south contact orientation avoids overstress
- High pin retention
- Polarized
- Friction lock

Reference Information

Product Specification: PS-99020-0001
Packaging: Tray
Mates With: 90142
Designed In: Inches

Electrical

Voltage: 350V
Current: 3.0A
Contact Resistance: 20 milliohms max.
Insulation Resistance: 1000 Megohms min.

Mechanical

Contact Retention to Housing: 20N (2.0kgf) min.
Mating Force: 1N max. Gold and 3N max. Tin
Unmating Force: 0.2N min. Gold and 0.2N min. Tin
Normal Force: 1N

Physical

Housing: Black glass-filled polyester, UL 94V-0
Contact: Copper Alloy, 0.64mm (.025") square pins
Plating: See Table

Plating A: 4µm (160µ") Tin over Nickel
Plating E: 0.38µm (15µ") selective Gold over Nickel and 4µm (160µ") Tin over Nickel
Plating F: 0.76µm (30µ") selective Gold over Nickel and 4µm (160µ") Tin over Nickel

Not For Use With Molex SL™ Components

Circuits	Order No.			Lead-free
	Plating A	Plating E	Plating F	
6	90130-1106	90130-1206	90130-1306	Yes
8	90130-1108	90130-1208	90130-1308	
10	90130-1110	90130-1210	90130-1310	
12	90130-1112	90130-1212	90130-1312	
14	90130-1114	90130-1214	90130-1314	
16	90130-1116	90130-1216	90130-1316	
18	90130-1118	90130-1218	90130-1318	
20	90130-1120	90130-1220	90130-1320	
24	90130-1124	90130-1224	90130-1324	

Circuits	Order No.			Lead-free
	Plating A	Plating E	Plating F	
26	90130-1126	90130-1226	90130-1326	Yes
30	90130-1130	90130-1230	90130-1330	
34	90130-1134	90130-1234	90130-1334	
38	90130-1138	90130-1238	90130-1338	
40	90130-1140	90130-1240	90130-1340	
50	90130-1150	90130-1250	90130-1350	
60	90130-1160	90130-1260	90130-1360	
64	90130-1164	90130-1264	90130-1364	

For other available circuit sizes contact Molex

2.54mm (.100") Pitch C-Grid III™ Shrouded Header

90130 Dual Row, Right Angle Fully Loaded

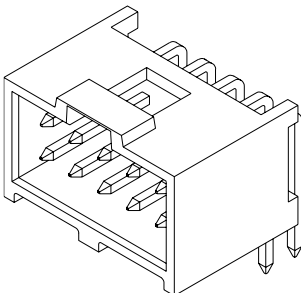

Features and Benefits

- Sizes 6 to 64 circuits
- Contact and plating orientation according to DIN 41651
- North/south contact orientation avoids overstress
- High pin retention
- Polarized
- Friction lock

Reference Information

Product Specification: PS-99020-0001
Packaging: Tray
Mates With: 90142
Designed In: Inches

Electrical

Voltage: 350V max.
Current: 3.0A
Contact Resistance: 20 milliohms max.
Insulation Resistance: 1000 Megohms min.

Mechanical

Contact Retention to Housing: 20N (2.0kgf) min.
Mating Force: 1N max. Gold and 3N max. Tin
Unmating Force: 0.2N min. Gold and 0.2N min. Tin
Nominal Force: 1N

Physical

Housing: Black glass-filled polyester, UL 94V-0
Contact: Copper Alloy, 0.64mm (.025") square pins
Plating: See Table

Plating A: 4µm (160µ") Tin over Nickel
Plating E: 0.38µm (15µ") selective Gold over Nickel and 4µm (160µ") Tin over Nickel
Plating F: 0.76µm (30µ") selective Gold over Nickel and 4µm (160µ") Tin over Nickel

Not For Use With Molex SL™ Components

Circuits	Order No.			Lead-free
	Plating A	Plating E	Plating F	
6	90130-3106	90130-3206	90130-3306	Yes
8	90130-3108	90130-3208	90130-3308	
10	90130-3110	90130-3210	90130-3310	
12	90130-3112	90130-3212	90130-3312	
14	90130-3114	90130-3214	90130-3314	
16	90130-3116	90130-3216	90130-3316	
18	90130-3118	90130-3218	90130-3318	
20	90130-3120	90130-3220	90130-3320	
24	90130-3124	90130-3224	90130-3324	

Circuits	Order No.			Lead-free
	Plating A	Plating E	Plating F	
26	90130-3126	90130-3226	90130-3326	Yes
30	90130-3130	90130-3230	90130-3330	
34	90130-3134	90130-3234	90130-3334	
38	90130-3138	90130-3238	90130-3338	
40	90130-3140	90130-3240	90130-3340	
50	90130-3150	90130-3250	90130-3350	
60	90130-3160	90130-3260	90130-3360	
64	90130-3164	90130-3264	90130-3364	

For other available circuit sizes contact Molex

2.54mm (.100") Pitch C-Grid III™ PC Board Connectors

90151 Dual Row, Vertical

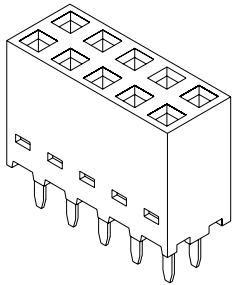

Features and Benefits

- Sizes 4 to 64 circuits
- Contact and plating orientation according to DIN 41651
- Stackable in 2 directions
- Meets HE 13/14 specification

Reference Information

Product Specification: PS-99020-0001
Packaging: Tube
Mates With: 0.64mm (.025") square pins
Use With: 1.57mm (.062") thick PC boards
Designed In: Inches

Electrical

Voltage: 350V
Current: 3.0A
Contact Resistance: 20 milliohms max.
Insulation Resistance: 1000 Megohms min.

Mechanical

Contact Retention to Housing: 15N min.
Mating Force: 1N max. Gold and 3N max. Tin
Unmating Force: 0.2N min. Gold and 0.2N min. Tin
Normal Force: 1N

Physical

Housing: Black glass-filled polyester, UL 94V-0
Contact: Copper Alloy
Plating: See Table
Recommended Mating Pin Length:
5.65mm (.222") min. to 7.00mm (.275") max.

Plating A: 1.00µm (39µ") min. Hot Tin dip
Plating E: 0.38µm (15µ") selective Gold over Nickel and 4µm (160µ") Tin over Nickel
Plating F: 0.76µm (30µ") selective Gold over Nickel and 4µm (160µ") Tin over Nickel

Not For Use With Molex SL™ Components

Circuits	Order No.						Lead-free
	Straight Tail			Kinked Tail			
	Plating A	Plating E	Plating F	Plating A	Plating E	Plating F	
4	90151-2104	90151-2204	90151-2304	90151-3104	90151-3204	90151-3304	Yes
6	90151-2106	90151-2206	90151-2306	90151-3106	90151-3206	90151-3306	
8	90151-2108	90151-2208	90151-2308	90151-3108	90151-3208	90151-3308	
10	90151-2110	90151-2210	90151-2310	90151-3110	90151-3210	90151-3310	
14	90151-2114	90151-2214	90151-2314	90151-3114	90151-3214	90151-3314	
16	90151-2116	90151-2216	90151-2316	90151-3116	90151-3216	90151-3316	
20	90151-2120	90151-2220	90151-2320	90151-3120	90151-3220	90151-3320	
26	90151-2126	90151-2226	90151-2326	90151-3126	90151-3226	90151-3326	
34	90151-2134	90151-2234	90151-2334	90151-3134	90151-3234	90151-3334	
40	90151-2140	90151-2240	90151-2340	90151-3140	90151-3240	90151-3340	
50	90151-2150	90151-2250	90151-2350	90151-3150	90151-3250	90151-3350	
60	90151-2160	90151-2260	90151-2360	90151-3160	90151-3260	90151-3360	
64	90151-2164	90151-2264	90151-2364	90151-3164	90151-3264	90151-3364	

For other available circuit sizes contact Molex

2.54mm (.100") Pitch C-Grid III™ PC Board Connectors

90152 Dual Row, Horizontal

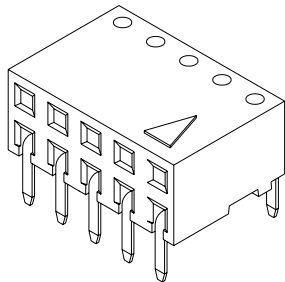

Features and Benefits

- Sizes 4 to 64 circuits
- Contact and plating orientation according to DIN 41651
- Stackable end-to-end
- Meets HE 13/14 specification

Reference Information

Product Specification: PS-99020-0001
Packaging: Tube
Mates With: 0.64mm (.025") square pins
Use With: 1.57mm (.062") thick PC boards
Designed In: Inches

Electrical

Voltage: 350V
Current: 3.0A
Contact Resistance: 20 milliohms max.
Insulation Resistance: 1000 Megohms min.

Mechanical

Contact Retention to Housing: 8.8N min.
Mating Force: 1N max. Gold and 3N max. Tin
Unmating Force: 0.2N min. Gold and 0.2N min. Tin
Normal Force: 1N

Physical

Housing: Black glass-filled polyester, UL 94V-0
Contact: Copper Alloy
Plating: See Table
Recommended Mating Pin Length:
5.65mm (.222") min. to 7.00mm (.275") max.

Plating A: 1.00µm (39µ") min. Hot Tin dip
Plating E: 0.38µm (15µ") selective Gold over Nickel and 4µm (160µ") Tin over Nickel
Plating F: 0.76µm (30µ") selective Gold over Nickel and 4µm (160µ") Tin over Nickel

Not For Use With Molex SL™ Components

Circuits	Order No.						Lead-free	
	Straight Tail			Kinked Tail				
	Plating A	Plating E	Plating F	Plating A	Plating E	Plating F		
4	90152-2104	90152-2204	90152-2304				Yes	
6	90152-2106	90152-2206	90152-2306					
8	90152-2108	90152-2208	90152-2308					
10	90152-2110	90152-2210	90152-2310					
14	90152-2114	90152-2214	90152-2314					
16	90152-2116	90152-2216	90152-2316					
20	90152-2120	90152-2220	90152-2320					
26	90152-2126	90152-2226	90152-2326					Yes
34	90152-2134	90152-2234	90152-2334					
40	90152-2140	90152-2240	90152-2340					
50	90152-2150	90152-2250	90152-2350					
60	90152-2160	90152-2260	90152-2360					
64	90152-2164	90152-2264	90152-2364					

For other available circuit sizes contact Molex

**2.54mm (.100") Pitch
KK®
Product Overview**

D

2.54mm (.100") Pitch PCB and Wire Connectors

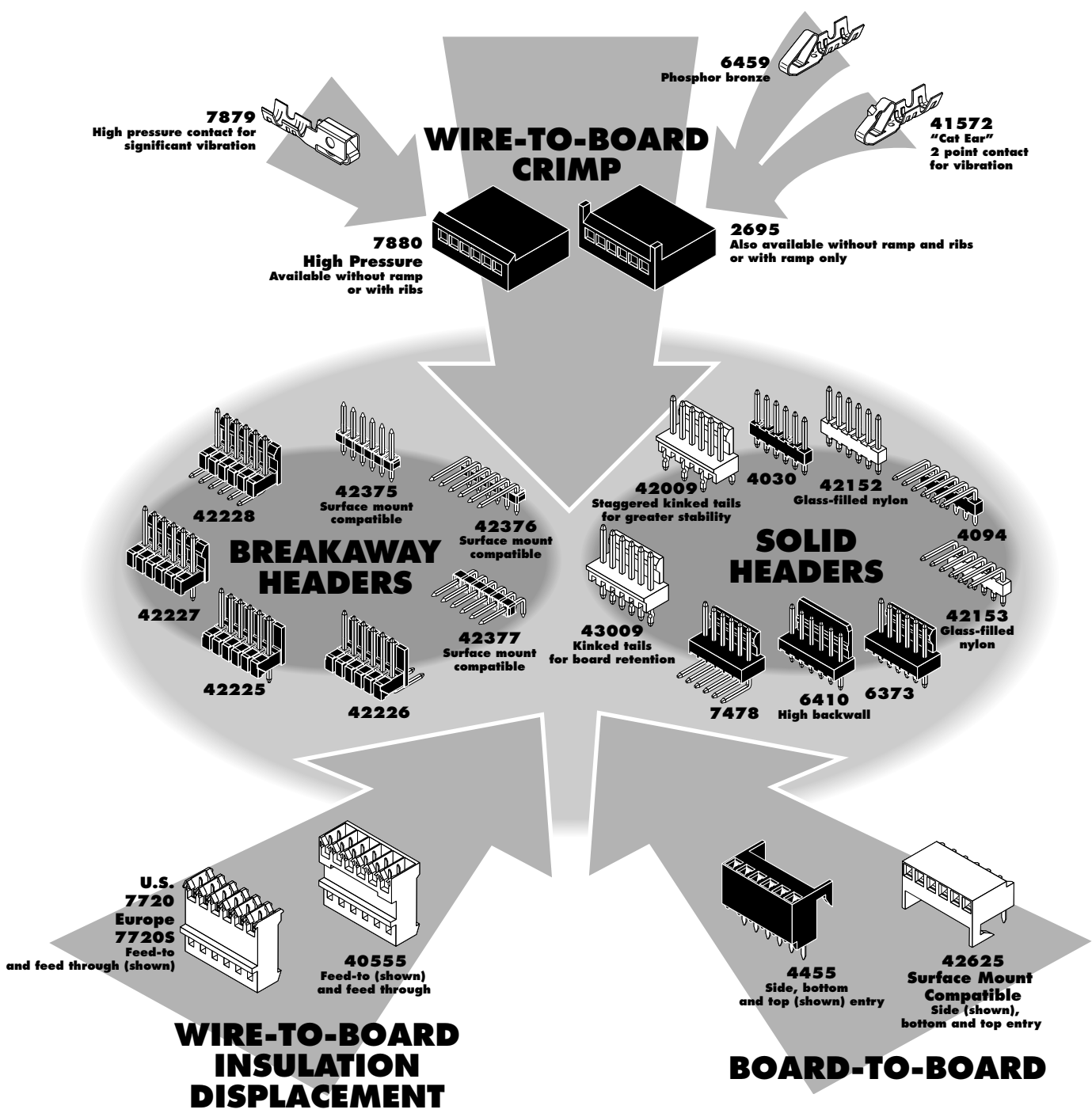

2.54mm (.100") Pitch KK[®] Crimp Terminal

2759/6459

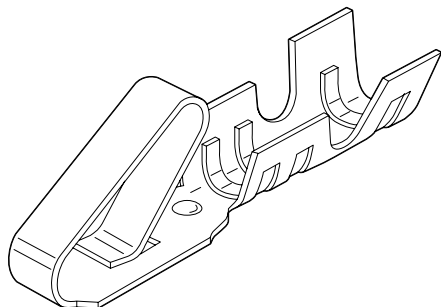

Features and Benefits

- Standard cantilever terminal
- Cantilever design provides high contact pressure
- Wiping action cleans oxides when connector is mated
- 2759 Series is Brass
- 6459 Series is Phosphor Bronze

Reference Information

Product Specification: PS-10-07
 Tooling Information: See crimp tooling section
 UL File No.: E29179
 CSA File No.: LR19980
 Use With: 2695, 5051 and 6745 housings

Electrical

Voltage: 250V
 Current: 6459—4.0A
 2759—2.5A
 Contact Resistance: 20 milliohms max.

Mechanical

Mating Force: 255g max. per contact
 Unmating Force: 50g min. per contact
 Normal Force: 200g min. per contact

Physical

Contact: 6459—Phosphor Bronze; 2759—Brass
 Wire Accommodation: 22 to 30 AWG

Contact	Order No.						Wire Gauge (AWG)	Insulation OD	Lead-free
	Tin Plating		15µm Gold Plating		15µm Selective Gold Plating				
	Reel	Bag	Reel	Bag	Reel	Bag			
Brass	08-50-0113	08-50-0114	08-56-0109	08-56-0110	08-55-0101	08-55-0102	22-30	1.57 (.062)	Yes
Phosphor Bronze	08-52-0101	08-52-0123	08-65-0813	08-65-0814	08-65-0815	08-65-0816			

2.54mm (.100") Pitch KK[®] Cat Ear Terminal

5159

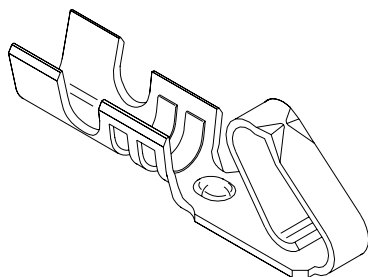

Features and Benefits

- Similar to 2759/6459 Series with cat ears
- Cat ears provide 2 high pressure points of contact
- Suitable for high vibrational requirements

Reference Information

Packaging: Bag or reel
 UL File No.: E29179
 CSA File No.: LR19980
 Use With: 2695, 5051 and 6471
 Designed In: Millimeters

Electrical

Voltage: 250V max.
 Current: 3.0A max.

Physical

Contact: Phosphor Bronze and Brass
 Plating: Tin
 Wire Accommodation: 22 to 28 AWG

Order No.				Lead-free
Phosphor Bronze		Brass		
Bag	Reel	Bag	Reel	
08-70-0049	08-70-0048	08-70-0069	08-70-0064	Yes

Preferred version in the Far East

2.54mm (.100") Pitch KK[®] Crimp Terminal

4809
Anti-Fishhooking

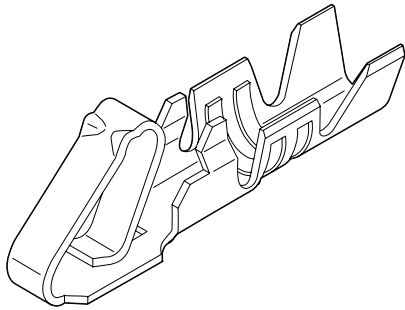

Features and Benefits

- Avoids tangling at pre-assembly
- Available with cat ears

Reference Information

Product Specification: PS-10-07
Tooling Information: See crimp tooling section
UL File No.: E29179
CSA File No.: LR19980
Used With: 5051-NM and 6471 housings

Electrical

Voltage: 250V
Current: 2.5A
Contact Resistance: 20 milliohms max.

Mechanical

Mating Force: 199g max. per contact
Unmating Force: 57g min. per contact
Normal Force: 300g per contact

Physical

Contact: Brass
Wire Accommodation: 22 to 30 AWG

Order No.		Plating	Crimp Wire Size	Insulation Diameter	Engineering No.	Lead-free
Bag	Reel					
08-50-0032	08-50-0031	1.00 to 2.50m Tin	22-30	1.57 (.062) max.	4809	Yes
08-55-0111	08-55-0110	0.38m Gold in contact area only				
08-56-0115	08-56-0120	0.38m Gold in contact area, Gold flash overall				

2.54mm (.100") Pitch KK[®] Crimp Terminal

7879
High Pressure

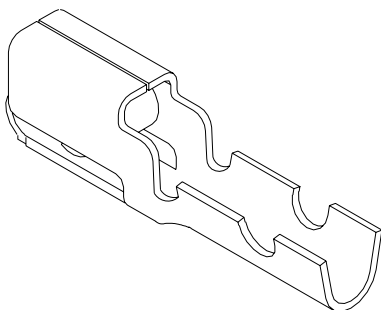

Features and Benefits

- Multiple contacting points
- Patented triple cantilever with box shroud
- Suitable for high vibration requirements
- Box shroud prevents contamination to the contact surface
- Crimping die or hand tool available

Reference Information

Product Specification: PS-7879
Tooling Information: See crimp tooling section
UL File No.: E29179
CSA File No.: LR19980
Use With: 7880 housings

Electrical

Voltage: 250V
Current: 2.5A
Contact Resistance: 10 milliohms max.

Mechanical

Mating Force: 475g max.
Unmating Force: 100g min.
Normal Force: 430g min.

Physical

Contact: Brass
Wire Accommodation: 22 to 30 AWG

Order No.		Plating	Wire Gauge (AWG)	Insulation Diameter	Lead-free
Reel	Bag				
08-50-0004	08-50-0005	Tin/Copper	22-30	1.57 (.062) max.	Yes
08-55-0124	08-55-0129	Select Gold			

Recommended wire range assumes stranded wire

2.54mm (.100") Pitch KK® Crimp Terminal Housing Receptacle

2695/6471

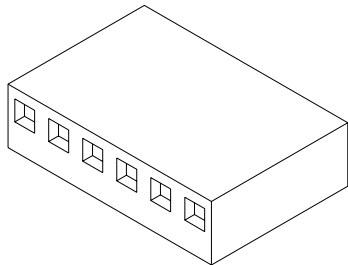

Features and Benefits

- Sizes 1 to 25 circuits
- 6471 is end-to-end stackable (2 housings only)
- 2695 version with or without locking ramp and polarizing ribs

Reference Information

Product Specification: PS-10-07
 UL File No.: E29179
 CSA File No.: LR19980
 Mates With: Molex KK 2.54mm (.100") pitch headers and
 0.04mm (.025") pins
 Use With: 2695—2759, 6459 or 41572 terminals
 6471—4809 terminals

Mechanical*

Locking: Passive, none

Physical

Housing: Nylon, UL 94V-0

Circuits	Order No.			
	2695		6471	
	With Locking Ramp	With Locking Ramp and Polarizing Ribs	Without Locking Ramp or Ribs	With Locking Ramp and Polarizing Ribs [†]
1			22-01-2011	
2	22-01-2027	22-01-3027	22-01-2021	22-01-2025
3	22-01-2037	22-01-3037	22-01-2031	22-01-2035
4	22-01-2047	22-01-3047	22-01-2041	22-01-2045
5	22-01-2057	22-01-3057	22-01-2051	22-01-2055
6	22-01-2067	22-01-3067	22-01-2061	22-01-2065
7	22-01-2077	22-01-3077	22-01-2071	22-01-2075
8	22-01-2087	22-01-3087	22-01-2081	22-01-2085
9	22-01-2097	22-01-3097	22-01-2091	22-01-2095
10	22-01-2107	22-01-3107	22-01-2101	22-01-2105
11	22-01-2117	22-01-3117	22-01-2111	22-01-2115
12	22-01-2127	22-01-3127	22-01-2121	22-01-2125
13	22-01-2137	22-01-3137	22-01-2131	22-01-2135

Circuits	Order No.			
	2695		6471	
	With Locking Ramp	With Locking Ramp and Polarizing Ribs	Without Locking Ramp or Ribs	With Locking Ramp and Polarizing Ribs [†]
14	22-01-2147	22-01-3147	22-01-2141	22-01-2145
15	22-01-2157	22-01-3157	22-01-2151	22-01-2155
16	22-01-2167	22-01-3167	22-01-2161	22-01-2165
17	22-01-2177	22-01-3177	22-01-2171	22-01-2175
18	22-01-2187	22-01-3187	22-01-2181	22-01-2185
19	22-01-2197	22-01-3197	22-01-2191	
20	22-01-2207	22-01-3207	22-01-2201	
21	22-01-2217	22-01-3217	22-01-2211	
22	22-01-2227	22-01-3227	22-01-2221	
23	22-01-2237	22-01-3237	22-01-2231	
24	22-01-2247	22-01-3247	22-01-2241	
25	22-01-2257	22-01-3257	22-01-2251	

Note: When mating polarizing rib version with breakaway friction lock header or polarizing wall series, the end friction lock or polarizing wall of header must be removed

* When mated with Molex product only

† For circuits 19-28, contact Molex

Order No.	
Polarizing Key	Polarizing Peg
15-04-9209	15-04-9210

2.54mm (.100") Pitch KK® Crimp Terminal Housing High Pressure

7880

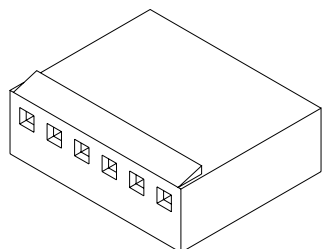

Features and Benefits

- Sizes 1 to 28 circuits
- Standard with locking ramp
- Suitable for high vibration requirements

Reference Information

Product Specification: PS-7879
 UL File No.: E29179
 CSA File No.: LR19980
 Mates With: Molex KK 2.54mm (.100") pitch headers
 Use With: 7879 terminals

Mechanical

Locking: Passive, none

Physical

Housing: Nylon, UL 94V-0

Circuits	Order No.
1	10-11-2013
2	10-11-2023
3	10-11-2033
4	10-11-2043
5	10-11-2053
6	10-11-2063
7	10-11-2073
8	10-11-2083
9	10-11-2093
10	10-11-2103

Circuits	Order No.
11	10-11-2113
12	10-11-2123
13	10-11-2133
14	10-11-2143
15	10-11-2153
16	10-11-2163
17	10-11-2173
18	10-11-2183
19	10-11-2193

Circuits	Order No.
20	10-11-2203
21	10-11-2213
22	10-11-2223
23	10-11-2233
24	10-11-2243
25	10-11-2253
26	10-11-2263
27	10-11-2273
28	10-11-2283

Note: In the Far East this housing has a different Engineering Series No. and different Order No.



2.54mm (.100") Pitch KK[®] Connector

7720
24, 26 or 28 AWG, IDT
Double Cantilever Contact

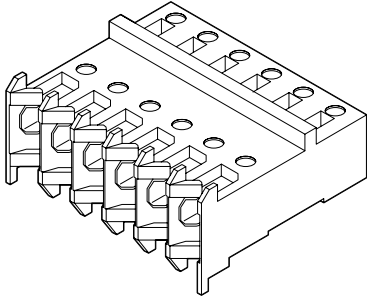

Features and Benefits

- Sizes 2 to 28 circuits
- 4 points of contact on conductor
- Feed-to and feed-through versions available
- End-to-end polarization optional
- Molded-in strain reliefs
- Terminals available with Gold plating (contact Molex for details)

Reference Information

Product Specification: PS-7690
UL File No.: E29179
CSA File No.: LR19980
Mates With: Molex KK 2.54mm (.100") pitch headers and 0.64mm (.025") pins
Use Molex Cable: 7234, 7307, 7767, 8996, 8997, 24214 and 24241

Electrical

Voltage: 250V
Current: 3.5A max. (24 AWG)
Contact Resistance: 20 milliohms max.

Mechanical

Contact Retention to Housing: 6 lb min.
Mating Force: 255g max.
Unmating Force: 85g min.
Normal Force: 6.5 oz min.

Physical

Housing: Nylon, UL 94V-2
Contact: Phosphor Bronze
Plating: Tin
Wire Range: 0.76 to 1.52mm (.030 to .060") OD max. (Discrete Wire) and 0.76 to 1.27mm (.030 to .050") OD max. (mass termination)

Order No.						Color	Type of Wire Terminated	Lead-free
Feed-Through		Feed-To						
Without Ramp	With Ramp	With Polarized Ramp	Without Ramp	With Ramp	With Polarized Ramp			
22-26-7XX1	22-26-8XX1	22-26-9XX1	22-41-3XX1	22-41-4XX1	22-41-5XX1	Brown	26 AWG stranded or solid, and 28 AWG solid, stranded or fused	Yes
22-26-7XX2	22-26-8XX2	22-26-9XX2	22-41-3XX2	22-41-4XX2	22-41-5XX2	Green	24 AWG stranded, solid, fused, topcoat, and 26 AWG fused and topcoat	

Replace XX with number of circuits, 02 to 28

Note: Some wires require deviation from chart

Order No.		
Polarizing Key	Feed To	Feed Through
15-04-0292	15-05-8XX7	15-05-8XX5

2.54mm (.100") Pitch KK[®] Connector

7720
22 AWG, IDT
Double Cantilever Contact

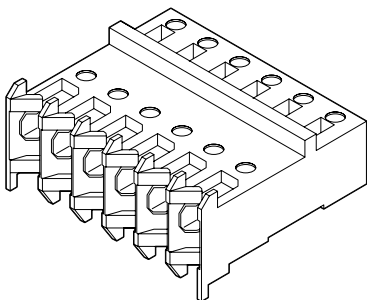

Features and Benefits

- Sizes 2 to 28 circuits
- 4 points of contact on conductor
- Feed-to and feed-through versions available
- End-to-end polarization optional
- Molded-in strain reliefs
- Terminals available with Gold plating (contact Molex for details)

Reference Information

Product Specification: PS-7690
UL File No.: E29179
CSA File No.: LR19980
Mates With: Molex KK 2.54mm (.100") pitch headers and 0.64mm (.025") pins
Use Molex Cable: 7234, 7307, 7767, 8996, 8997, 24214 and 24241

Electrical

Voltage: 250V
Current: 3.5A max.
Contact Resistance: 20 milliohms max.

Mechanical

Contact Retention to Housing: 6 lb min.
Mating Force: 255g max. per contact
Unmating Force: 85g min. per contact
Normal Force: 6.5 oz min. per contact

Physical

Housing: Nylon, UL 94V-2
Contact: Phosphor Bronze
Plating: Tin
Wire Range: 0.76 to 1.52mm (.030 to .060") OD max. (Discrete Wire) and 0.76 to 1.27mm (.030 to .050") OD max. (mass termination)

Order No.						Color	Type of Wire Terminated	Lead-free
Feed-Through			Feed-To					
Without Ramp	With Ramp	With Polarized Ramp	Without Ramp	With Ramp	With Polarized Ramp			
22-42-6XX0	22-42-6XX1	22-42-6XX2	22-42-6XX3	22-42-6XX4	22-42-6XX5	Black	22 AWG stranded tinned	Yes

Replace XX with number of circuits, 02 to 28

Order No.		
Polarizing Key	Feed To	Feed Through
15-04-0292	15-05-8XX7	15-05-8XX5

2.54mm (.100") Pitch KK[®] Connector

7720S

**IDT, High Pressure
Cat Ear Contact System**

D

2.54mm (.100") Pitch PCB and Wire Connectors

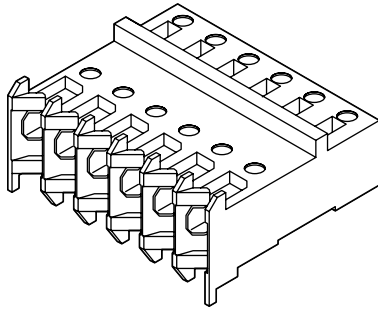

Features and Benefits

- Sizes 2 to 28 circuits
- Standard with locking ramp
- Molded-in strain reliefs

Reference Information

Product Specification: PSX-7690S
 Tooling Information: See end of section
 UL File No.: E29179
 CSA File No.: LR19980
 Mates With: Molex KK 2.54mm (.100") pitch headers
 and 0.64mm (.025") pins
 Use Molex Cable: 7234, 7307, 7767, 8996, 8997,
 24214, 24226 and 24241

Electrical

Voltage: 250V
 Current: 2.5A
 Contact Resistance: 20 milliohms max.

Mechanical

Contact Retention to Housing: 8 lb min.
 Wire Pull-Out Force: 1.35 lb min. per contact
 Mating Force: 9 oz max. per contact
 Unmating Force: 2 oz min. per contact
 Normal Force: 6.5 oz min. per contact

Physical

Housing: Nylon, UL 94V-2
 Contact: Brass
 Plating: Tin
 Wire Range: 0.76mm (.030") to 1.42mm (.056") OD

Circuits	Version		Lead-free
	H	J	
2	22-50-3025	38-00-2092	Yes
3	22-50-3035	38-00-2093	
4	22-50-3045	38-00-2094	
5	22-50-3055	38-00-2095	
6	22-50-3065	38-00-2096	
7	22-50-3075	38-00-2097	
8	22-50-3085	38-00-2098	
9	22-50-3095	38-00-2099	
10	22-50-3105	38-00-2100	

Circuits	Version		Lead-free
	H	J	
11	22-50-3115	38-00-2101	Yes
12	22-50-3125	38-00-2102	
13	22-50-3135	38-00-2103	
14	22-50-3145	38-00-2104	
15	22-50-3155	38-00-2105	
16	22-50-3165	38-00-2106	
17	22-50-3175	38-00-2107	
18	22-50-3185	38-00-2108	
19	22-50-3195	38-00-2109	

Circuits	Version		Lead-free
	H	J	
20	22-50-3205	38-00-2110	Yes
21	22-50-3215	38-00-2111	
22	22-50-3225	38-00-2112	
23	22-50-3235	38-00-2113	
24	22-50-3245	38-00-2114	
25	22-50-3255	38-00-2115	
26	22-50-3265	38-00-2116	
27	22-50-3275	38-00-2117	
28	22-50-3285	38-00-2118	

Color Identification Stripe		Type of Wire Terminated [all wires have a max. insulation diameter of 1.42mm (.056")]
ID Slot Version	Color	
H	Green	24 AWG stranded, 26 AWG solid and fused, and 28 AWG fused
J	Brown	26 AWG stranded, and 28 AWG solid and stranded

Order No.	
Polarizing Key	15-04-0292

2.54mm (.100") Pitch KK[®] Breakaway Header

42375
Vertical

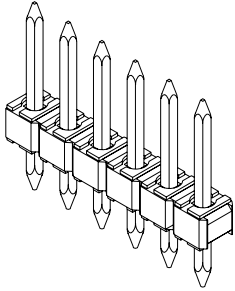

Features and Benefits

- Sizes 2 to 36 circuits
- Available with kinked PC tails
- .240, .295 and .320" standard mating lengths
- Voided circuits available (contact Molex)

Reference Information

Product Specification: PS-10-07
UL File No.: E29179
CSA File No.: LR19980
Mates With: 2695, 4455, 6471, 7720, 7859, 7880,
40556, 70066A, 70400A, 70430, 90147
and 90148

Electrical

Voltage: 250V
Current: 4.0A
Contact Resistance: 20 milliohms max.

Mechanical

Durability: Tin—25 cycles max.
Gold—100 cycles max.

Physical

Housing: 4/6 glass-filled nylon, UL 94V-0
Contact: Phosphor Bronze

Plating Option	Order No.						Lead-free
	Mating End Length = 6.09mm (.240")		Mating End Length = 7.49mm (.295")		Mating End Length = 8.13mm (.320")		
	PC Tail Length = 3.18mm (.125")	PC Tail Length = 3.43mm (.135") Kinked PC Tail	PC Tail Length = 3.05mm (.120")	PC Tail Length = 3.43mm (.135") Kinked PC Tail	PC Tail Length = 3.05mm (.130")	PC Tail Length = 3.43mm (.135") Kinked PC Tail	
Tin	22-28-4XX0	22-28-5XX0	22-28-4XX2	22-28-5XX2	22-28-4XX1	22-28-5XX1	Yes
15 μ m select Gold	22-28-4XX3	22-28-5XX3	22-28-4XX5	22-28-5XX5	22-28-4XX4	22-28-5XX4	
30 μ m select Gold	22-28-4XX6	22-28-5XX6	22-28-4XX8	22-28-5XX8	22-28-4XX7	22-28-5XX7	

Replace XX with no. of circuits, 02-36

2.54mm (.100") Pitch KK[®] Breakaway Header

42377
Right Angle

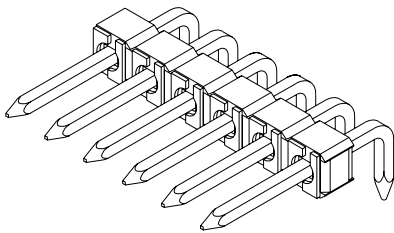

Features and Benefits

- Sizes 2 to 36 circuits
- Available with kinked PC tails
- .244 or .324" standard mating lengths
- Voided circuits available (contact Molex)
- Various pin lengths available

Reference Information

Product Specification: PS-10-07
UL File No.: E29179
CSA File No.: LR19980
Mates With*: 2695, 4455, 6471, 7720, 7859, 7880,
40556, 70066A, 70400A, 70430, 90147 and 90148

Electrical

Voltage: 250V
Current: 4.0A
Contact Resistance: 20 milliohms max.

Mechanical

Durability: Tin—25 cycles max.
Gold—100 cycles max.

Physical

Housing: 4/6 glass-filled nylon, UL 94V-0
Contact: Phosphor Bronze

Plating Option	Order No.				Lead-free
	Mating End Length = 6.20mm (.244")		Mating End Length = 8.23mm (.324")		
	PC Tail Length = 3.05mm (.120")	PC Tail Length = 3.43mm (.135") Kinked PC Tail	PC Tail Length = 3.05mm (.120")	PC Tail Length = 3.43mm (.135") Kinked PC Tail	
Tin	22-28-8XX0	22-28-9XX0	22-28-8XX1	22-28-9XX1	Yes
15 μ m select Gold	22-28-8XX2	22-28-9XX2	22-28-8XX3	22-28-9XX3	
30 μ m select Gold	22-28-8XX4	22-28-9XX4	22-28-8XX5	22-28-9XX5	

Replace XX with no. of circuits, 02-36

* 2695, 4455 and 7880 mate when 42377 is at board edge only
Circuit 1 designation is used to orient the header to locate the voided circuit. Review mating connector to assure correct mating orientation.

2.54mm (.100") Pitch KK[®] Breakaway Header

42376
Right Angle

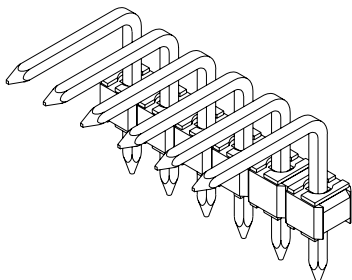

Features and Benefits

- Sizes 2 to 36 circuits
- Available with kinked PC tails
- .361 and .405" standard mating lengths
- Tin and 15 or 30µ" Gold plating
- Voids optional (contact Molex)
- Surface Mount Compatible

Reference Information

Product Specification: PS-10-07
UL File No.: E29179
CSA File No.: LR19980
Mates With: 2695, 4455, 6471, 7720, 7859, 7880, 40556, 70066A, 70400A, 70430, 90147 and 90148

Electrical

Voltage: 250V
Current: 4.0A
Contact Resistance: 20 milliohms max.

Mechanical

Durability: Tin—25 cycles max.
Gold—100 cycles max.

Physical

Housing: 4/6 glass-filled nylon, UL 94V-0
Contact: Phosphor Bronze

Plating Option	Order No.			
	M = 9.17mm (.361") C = 3.61mm (.142") P = 3.06mm (.120")	M = 9.17mm (.361") C = 3.61mm (.142") P = 3.43mm (.135") Kinked PC Tail	M = 10.29mm (.405") C = 6.30mm (.248") P = 3.06mm (.120")	M = 10.29mm (.405") C = 6.30mm (.248") P = 3.43mm (.135") Kinked PC Tail
Tin	22-28-6XX0	22-28-7XX0	22-28-6XX1	22-28-7XX1
15µ" select Gold	22-28-6XX2	22-28-7XX2	22-28-6XX3	22-28-7XX3
30µ" select Gold	22-28-6XX4	22-28-7XX4	22-28-6XX5	22-28-7XX5

Replace XX with no. of circuits, 02-36

Note: Dimension M = Mating End, Dimension C = Mating Height and Dimension P = PC Tail
Circuit 1 designation is used to orient the header to locate the voided circuit. Review mating connector to assure correct mating orientation.

2.54mm (.100") Pitch KK[®] Solid Header

4030
Vertical

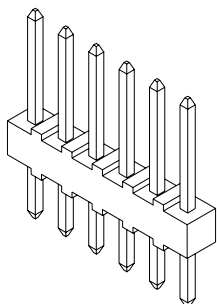

Features and Benefits

- Sizes 2 to 28 circuits
- 4030 with voids is 4380 Series
- Various pin lengths available
- Voids optional (contact Molex)

Reference Information

Product Specification: PS-10-07
UL File No.: E29179
CSA File No.: LR19980
Mates With: 2695, 4455, 6471, 7720 and 7880

Electrical

Voltage: 250V
Current: 4.0A
Contact Resistance: 20 milliohms max.

Mechanical

Durability: Tin—25 cycles max.
Gold—100 cycles max.

Physical

Housing: Nylon, UL 94V-0
Contact: Brass

Circuits	Order No.		Lead-free
	Tin	Gold	
2	22-03-2021	22-10-2021	Yes
3	22-03-2031	22-10-2031	
4	22-03-2041	22-10-2041	
5	22-03-2051	22-10-2051	
6	22-03-2061	22-10-2061	
7	22-03-2071	22-10-2071	
8	22-03-2081	22-10-2081	
9	22-03-2091	22-10-2091	
10	22-03-2101	22-10-2101	

Circuits	Order No.		Lead-free
	Tin	Gold	
11	22-03-2111	22-10-2111	Yes
12	22-03-2121	22-10-2121	
13	22-03-2131	22-10-2131	
14	22-03-2141	22-10-2141	
15	22-03-2151	22-10-2151	
16	22-03-2161	22-10-2161	
17	22-03-2171	22-10-2171	
18	22-03-2181	22-10-2181	
19	22-03-2191	22-10-2191	

Circuits	Order No.		Lead-free
	Tin	Gold	
20	22-03-2201	22-10-2201	Yes
21	22-03-2211	22-10-2211	
22	22-03-2221	22-10-2221	
23	22-03-2231	22-10-2231	
24	22-03-2241	22-10-2241	
25	22-03-2251	22-10-2251	
26	22-03-2261	22-10-2261	
27	22-03-2271	22-10-2271	
28	22-03-2281	22-10-2281	

Note: In the Far East, the polyester product has different Engineering No. and Order No.

Circuit 1 designation is used to orient the header to locate the voided circuit. Review mating connector to assure correct mating orientation.



2.54mm (.100") Pitch KK[®] Solid Header

4094 Right Angle

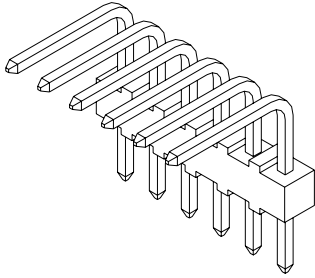

Circuits	Order No.		Lead-free
	Tin	Gold	
2	22-05-2021	22-12-2021	Yes
3	22-05-2031	22-12-2031	
4	22-05-2041	22-12-2041	
5	22-05-2051	22-12-2051	
6	22-05-2061	22-12-2061	
7	22-05-2071	22-12-2071	
8	22-05-2081	22-12-2081	
9	22-05-2091	22-12-2091	
10	22-05-2101	22-12-2101	

Note: In the Far East the polyester product has different Engineering No. and Order No.

Features and Benefits

- Sizes 2 to 28 circuits
- 4094 with voids is 4494 Series
- Various pin lengths available
- Voided circuits available (contact Molex)

Reference Information

Product Specification: PS-10-07
UL File No.: E29179
CSA File No.: LR19980
Mates With: 2695, 4455, 6471, 7720 and 7880

Electrical

Voltage: 250V
Current: 4.0A
Contact Resistance: 20 milliohms max.

Mechanical

Durability: Tin—25 cycles max.
Gold—100 cycles max.

Physical

Housing: Nylon, UL 94V-0
Contact: Brass

Circuits	Order No.		Lead-free
	Tin	Gold	
11	22-05-2111	22-12-2111	Yes
12	22-05-2121	22-12-2121	
13	22-05-2131	22-12-2131	
14	22-05-2141	22-12-2141	
15	22-05-2151	22-12-2151	
16	22-05-2161	22-12-2161	
17	22-05-2171	22-12-2171	
18	22-05-2181	22-12-2181	

Circuits	Order No.		Lead-free
	Tin	Gold	
19	22-05-2191	22-12-2191	Yes
20	22-05-2201	22-12-2201	
21	22-05-2211	22-12-2211	
22	22-05-2221	22-12-2221	
23	22-05-2231	22-12-2231	
24	22-05-2241	22-12-2241	
25	22-05-2251	22-12-2251	
28	22-05-2281	22-12-2281	

2.54mm (.100") Pitch KK[®] Solid Header

6373 Vertical, Friction Lock

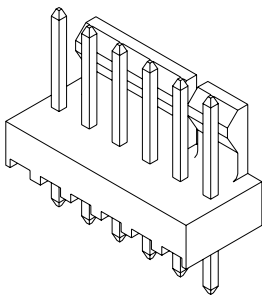

Circuits	Order No.		Lead-free
	Tin	Gold	
2	22-23-2021	22-11-2022	Yes
3	22-23-2031	22-11-2032	
4	22-23-2041	22-11-2042	
5	22-23-2051	22-11-2052	
6	22-23-2061	22-11-2062	
7	22-23-2071	22-11-2072	
8	22-23-2081	22-11-2082	
9	22-23-2091	22-11-2092	
10	22-23-2101	22-11-2102	

Note: Circuit 1 designation is used to orient the header to locate the voided circuit. Review mating connector to assure correct mating orientation.

Features and Benefits

- Sizes 2 to 28 circuits
- Friction lock provides passive lock to connector with ramp
- Good in high vibration applications
- Various pin lengths available
- Voided circuits available (contact Molex)

Reference Information

Product Specification: PS-10-07
UL File No.: E29179
CSA File No.: LR19980
Mates With: 2695, 4455, 6471, 7720 and 7880

Electrical

Voltage: 250V
Current: 4.0A
Contact Resistance: 20 milliohms max.

Mechanical

Durability: Tin—25 cycles max.
Gold—100 cycles max.

Physical

Housing: Nylon, UL 94V-0
Contact: Brass

Circuits	Order No.		Lead-free
	Tin	Gold	
11	22-23-2111	22-11-2112	Yes
12	22-23-2121	22-11-2122	
13	22-23-2131	22-11-2132	
14	22-23-2141	22-11-2142	
15	22-23-2151	22-11-2152	
16	22-23-2161	22-11-2162	
17	22-23-2171	22-11-2172	
18	22-23-2181	22-11-2182	
19	22-23-2191	22-11-2192	

Circuits	Order No.		Lead-free
	Tin	Gold	
20	22-23-2201	22-11-2202	Yes
21	22-23-2211	22-11-2212	
22	22-23-2221	22-11-2222	
23	22-23-2231	22-11-2232	
24	22-23-2241	22-11-2242	
25	22-23-2251	22-11-2252	
26	22-23-2261	22-11-2262	
27	22-23-2271	22-11-2272	
28	22-23-2281	22-11-2282	

2.54mm (.100") Pitch KK[®] Header

6410 Vertical Friction Lock

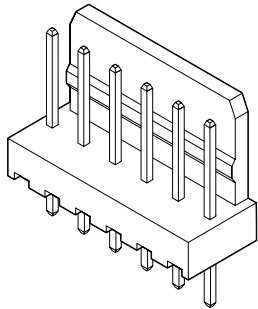

Features and Benefits

- Sizes 2 to 28 circuits
- Friction lock provides passive lock to connector with ramp
- Good in high vibration applications
- Higher backwall than the 6373 Series
- Various pin lengths available

Reference Information

Product Specification: PS-10-07
 UL File No.: E29179
 CSA File No.: LR19980
 Mates With: 2695 with locking ramp, 6471 and 7880

Electrical

Voltage: 250V
 Current: 4.0A
 Contact Resistance: 20 milliohms max.

Physical

Housing: Nylon, UL 94V-0
 Contact: Brass

Circuits	Order No.		Lead-free
	Tin	Gold	
2	22-27-2021	22-29-2021	Yes
3	22-27-2031	22-29-2031	
4	22-27-2041	22-29-2041	
5	22-27-2051	22-29-2051	
6	22-27-2061	22-29-2061	
7	22-27-2071	22-29-2071	
8	22-27-2081	22-29-2081	
9	22-27-2091	22-29-2091	
10	22-27-2101	22-29-2101	

Circuits	Order No.		Lead-free
	Tin	Gold	
11	22-27-2111	22-29-2111	Yes
12	22-27-2121	22-29-2121	
13	22-27-2131	22-29-2131	
14	22-27-2141	22-29-2141	
15	22-27-2151	22-29-2151	
16	22-27-2161	22-29-2161	
17	22-27-2171	22-29-2171	
18	22-27-2181	22-29-2181	
19	22-27-2191	22-29-2191	

Circuits	Order No.		Lead-free
	Tin	Gold	
20	22-27-2201	22-29-2201	Yes
21	22-27-2211	22-29-2211	
22	22-27-2221	22-29-2221	
23	22-27-2231	22-29-2231	
24	22-27-2241	22-29-2241	
25	22-27-2251	22-29-2251	
26	22-27-2261	22-29-2261	
27	22-27-2271	22-29-2271	
28	22-27-2281	22-29-2281	

2.54mm (.100") Pitch KK[®] Solid Header

7478 Right Angle, Friction Lock

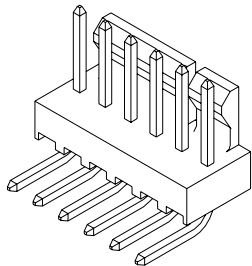

Features and Benefits

- Sizes 2 to 28 circuits
- Friction lock provides passive lock to connector with ramp
- 7478 with voids is 7832 Series
- Various pin lengths available
- End-to-end stackable
- Edge mount only

Reference Information

Product Specification: PS-10-07
 UL File No.: E29179
 CSA File No.: LR19980
 Mates With: 2695, 4455, 6471, 7720 and 7880

Electrical

Voltage: 250V
 Current: 4.0A
 Contact Resistance: 20 milliohms max.

Mechanical

Durability: Tin—25 cycles max.
 Gold—100 cycles max.

Physical

Housing: Nylon, UL 94V-0
 Contact: Brass

Circuits	Order No.		Lead-free
	Tin	Gold	
2	22-05-3021	22-12-2024	Yes
3	22-05-3031	22-12-2034	
4	22-05-3041	22-12-2044	
5	22-05-3051	22-12-2054	
6	22-05-3061	22-12-2064	
7	22-05-3071	22-12-2074	
8	22-05-3081	22-12-2084	
9	22-05-3091	22-12-2094	
10	22-05-3101	22-12-2104	

Circuits	Order No.		Lead-free
	Tin	Gold	
11	22-05-3111	22-12-2114	Yes
12	22-05-3121	22-12-2124	
13	22-05-3131	22-12-2134	
14	22-05-3141	22-12-2144	
15	22-05-3151	22-12-2154	
16	22-05-3161	22-12-2164	
17	22-05-3171	22-12-2174	
18	22-05-3181	22-12-2184	
19	22-05-3191	22-12-2194	

Circuits	Order No.		Lead-free
	Tin	Gold	
20	22-05-3201	22-12-2204	Yes
21	22-05-3211	22-12-2214	
22	22-05-3221	22-12-2224	
23	22-05-3231	22-12-2234	
24	22-05-3241	22-12-2244	
25	22-05-3251	22-12-2254	
26	22-05-3261	22-12-2264	
27	22-05-3271	22-12-2274	
28	22-05-3281	22-12-2284	

Note: Circuit 1 designation is used to orient the header to locate the voided circuit. Review mating connector to assure correct mating orientation.

2.54mm (.100") Pitch KK[®] Header

7395

**Right Angle, Square Pin
Friction Lock**

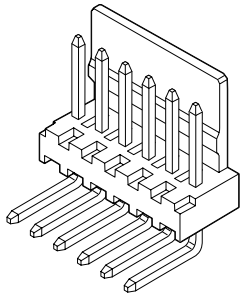

Features and Benefits

- Sizes 2 to 28 circuits
- Edge mount only

Reference Information

Product Specification: PS-10-07
 UL File No.: E29179
 CSA File No.: LR19980
 Mates With: 2695 with locking ramp, 6471 and 7880

Physical

Housing: Natural nylon, UL 94V-0
 Contact: Brass

Circuits	Order No.		Lead-free
	Tin	Gold	
2	22-05-7028	22-12-4022	Yes
3	22-05-7038	22-12-4032	
4	22-05-7048	22-12-4042	
5	22-05-7058	22-12-4052	
6	22-05-7068	22-12-4062	
7	22-05-7078	22-12-4072	
8	22-05-7088	22-12-4082	
9	22-05-7098	22-12-4092	
10	22-05-7108	22-12-4102	

Circuits	Order No.		Lead-free
	Tin	Gold	
11	22-05-7118	22-12-4112	Yes
12	22-05-7128	22-12-4122	
13	22-05-7138	22-12-4132	
14	22-05-7148	22-12-4142	
15	22-05-7158	22-12-4152	
16	22-05-7168	22-12-4162	
17	22-05-7178	22-12-4172	
18	22-05-7188	22-12-4182	
19	22-05-7198	22-12-4192	

Circuits	Order No.		Lead-free
	Tin	Gold	
20	22-05-7208	22-12-4202	Yes
21	22-05-7218	22-12-4212	
22	22-05-7228	22-12-4222	
23	22-05-7238	22-12-4232	
24	22-05-7248	22-12-4242	
25	22-05-7258	22-12-4252	
26	22-05-7268	22-12-4262	
27	22-05-7278	22-12-4272	
28	22-05-7288	22-12-4282	

D

2.54mm (.100") Pitch PCB and Wire Connectors

2.54mm (.100") Pitch KK® PC Board Connector

4455
Right Angle

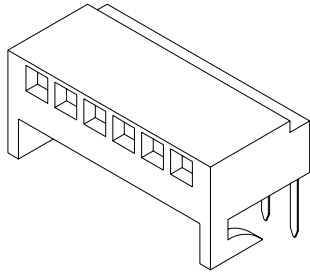

Features and Benefits

- Sizes 2 to 25 circuits
- End-to-end stackable
- See 44812 Series for high temperature version
- Thicker board hooks available

Reference Information

Product Specification: PS-10-07
UL File No.: E29179
CSA File No.: LR19980
Mates With: 4030, 4094, 4380, 42152, 42153, 42375, 42376 and 42377 headers and .025" square pins

Electrical

Voltage: 250V
Current: 2.5A max.*
Contact Resistance: 20 milliohms max.

Mechanical

Mating Force: 199g max.
Unmating Force: 57g min.

Physical

Housing: Nylon, UL 94V-0
Contact: Brass

2.54mm (.100") Pitch PCB and Wire Connectors

Circuits	Order No.				Lead-free
	Tin	Cat Ear Version	Gold	Select Gold	
2	22-15-2026	38-00-1332	22-16-2021	22-16-2020	Yes
3	22-15-2036	38-00-1333	22-16-2031	22-16-2030	
4	22-15-2046	38-00-1334	22-16-2041	22-16-2040	
5	22-15-2056	38-00-1335	22-16-2051	22-16-2050	
6	22-15-2066	38-00-1336	22-16-2061	22-16-2060	
7	22-15-2076	38-00-1337	22-16-2071	22-16-2070	
8	22-15-2086	38-00-1338	22-16-2081	22-16-2080	
9	22-15-2096	38-00-1339	22-16-2091	22-16-2090	
10	22-15-2106	38-00-1340	22-16-2101	22-16-2100	
11	22-15-2116	38-00-1341	22-16-2111	22-16-2110	
12	22-15-2126	38-00-1342	22-16-2121	22-16-2120	
13	22-15-2136	38-00-1343	22-16-2131	22-16-2130	
14	22-15-2146	38-00-1344	22-16-2141	22-16-2140	
15	22-15-2156	38-00-1345	22-16-2151	22-16-2150	
16	22-15-2166	38-00-1346	22-16-2161	22-16-2160	
17	22-15-2176	38-00-1347	22-16-2171	22-16-2170	
18	22-15-2186	38-00-1348	22-16-2181	22-16-2180	
19	22-15-2196	38-00-1349	22-16-2191	22-16-2190	
20	22-15-2206	38-00-1350	22-16-2201	22-16-2200	
21	22-15-2216	38-00-1351	22-16-2211	22-16-2210	
22	22-15-2226	38-00-1352	22-16-2221	22-16-2220	
23	22-15-2236	38-00-1353	22-16-2231	22-16-2230	
24	22-15-2246	38-00-1354	22-16-2241	22-16-2240	
25	22-15-2256	38-00-1355	22-16-2251	22-16-2250	

* Current rating is dependent upon PCB traces, Copper weight, solder, etc. (contact Molex for more information)

Order No.	
Polarizing Key 4161-1	15-04-9209

2.54mm (.100") Pitch KK[®] PC Board Connector

4455
Top Entry

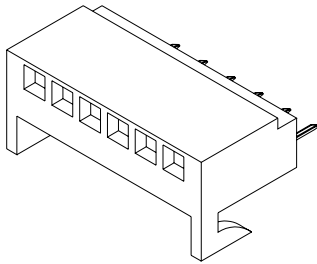

Features and Benefits

- Sizes 2 to 25 circuits
- End-to-end stackable
- Also available without board hooks (see table below)
- See 44812 Series for high temperature version
- Thicker board hooks available

Reference Information

Product Specification: PS-10-07
 UL File No.: E29179
 CSA File No.: LR19980
 Mates With: 4030, 4094, 42152, 42153, 42375, 42376, 42377, 70021 and 70475 headers and .025" square pins (edge mount only)

Electrical

Voltage: 250V
 Current: 2.5A max.*
 Contact Resistance: 20 milliohms max.

Mechanical

Contact Retention to Housing: 3.63kg (8 lb) min.
 Mating Force: 199g max.
 Unmating Force: 57g min.
 Normal Force: 300g average

Physical

Housing: Nylon, UL 94V-0
 Contact: Brass

Circuits	Order No.					Lead-free
	Tin			Gold		
	With Hooks	Without Hooks	Cat Ear Version	With Hooks	With Hooks	
2	22-02-2025	22-02-7023	38-00-1422	22-18-2023	22-18-2021	Yes
3	22-02-2035	22-02-7033	38-00-1423	22-18-2033	22-18-2031	
4	22-02-2045	22-02-7043	38-00-1424	22-18-2043	22-18-2041	
5	22-02-2055	22-02-7053	38-00-1425	22-18-2053	22-18-2051	
6	22-02-2065	22-02-7063	38-00-1426	22-18-2063	22-18-2061	
7	22-02-2075	22-02-7073	38-00-1427	22-18-2073	22-18-2071	
8	22-02-2085	22-02-7083	38-00-1428	22-18-2083	22-18-2081	
9	22-02-2095	22-02-7093	38-00-1429	22-18-2093	22-18-2091	
10	22-02-2105	22-02-7103	38-00-1430	22-18-2103	22-18-2101	
11	22-02-2115	22-02-7113	38-00-1431	22-18-2113	22-18-2111	
12	22-02-2125	22-02-7123	38-00-1432	22-18-2123	22-18-2121	
13	22-02-2135	22-02-7133	38-00-1433	22-18-2133	22-18-2131	
14			38-00-1434			
15	22-02-2155	22-02-7153	38-00-1435	22-18-2153	22-18-2151	
16	22-02-2165	22-02-7163	38-00-1436	22-18-2163	22-18-2161	
17	22-02-2175	22-02-7173	38-00-1437	22-18-2173	22-18-2171	
18	22-02-2185	22-02-7183	38-00-1438	22-18-2183	22-18-2181	
19	22-02-2195	22-02-7193	38-00-1439	22-18-2193	22-18-2191	
20	22-02-2205	22-02-7203	38-00-1440	22-18-2203	22-18-2201	
21	22-02-2215	22-02-7213	38-00-1441	22-18-2213	22-18-2211	
22	22-02-2225	22-02-7223	38-00-1442	22-18-2223	22-18-2221	
23	22-02-2235	22-02-7233	38-00-1443	22-18-2233	22-18-2231	
24	22-02-2245	22-02-7243	38-00-1444	22-18-2243	22-18-2241	
25	22-02-2255	22-02-7253	38-00-1445	22-18-2253	22-18-2251	

* Current rating is dependent upon PCB traces, Copper weight, solder, etc. (contact Molex for more information)

Order No.	
Polarizing Key 4161-1	15-04-9209

2.54mm (.100") Pitch KK® PC Board Connector

4455
Bottom Entry

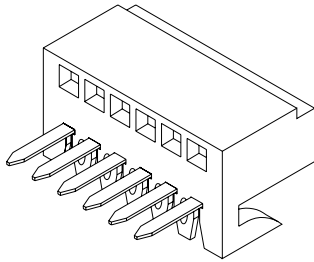

Features and Benefits

- Sizes 2 to 25 circuits
- End-to-end stackable
- Mating header must be long enough to accommodate board thickness
- See 42625 Series for high temperature version
- Thicker board hooks available

Reference Information

Product Specification: PS-10-07
 UL File No.: E29179
 CSA File No.: LR19980
 Mates With: 4030, 4094, 4380, 42152, 42153, 42375,
 42376 and 42377 headers and .025" square pins

Electrical

Voltage: 250V
 Current: 2.5A max.*
 Contact Resistance: 20 milliohms max.

Mechanical

Mating Force: 199g max.
 Unmating Force: 57g min.

Physical

Housing: Nylon, UL 94V-0
 Contact: Brass

2.54mm (.100") Pitch PCB and Wire Connectors

D

Circuits	Order No.				Lead-free
	Tin	Cat Ear Version	Gold	Select Gold	
2	22-14-2024	38-00-1392	22-17-2022	22-17-3022	Yes
3	22-14-2034	38-00-1393	22-17-2032	22-17-3032	
4	22-14-2044	38-00-1394	22-17-2042	22-17-3042	
5	22-14-2054	38-00-1395	22-17-2052	22-17-3052	
6	22-14-2064	38-00-1396	22-17-2062	22-17-3062	
7	22-14-2074	38-00-1397	22-17-2072	22-17-3072	
8	22-14-2084	38-00-1398	22-17-2082	22-17-3082	
9	22-14-2094	38-00-1399	22-17-2092	22-17-3092	
10	22-14-2104	38-00-1400	22-17-2102	22-17-3102	
11	22-14-2114	38-00-1401	22-17-2112	22-17-3112	
12	22-14-2124	38-00-1402	22-17-2122	22-17-3122	
13	22-14-2134	38-00-1403	22-17-2132	22-17-3132	
14	22-14-2144	38-00-1404	22-17-2142	22-17-3142	
15	22-14-2154	38-00-1405	22-17-2152	22-17-3152	
16	22-14-2164	38-00-1406	22-17-2162	22-17-3162	
17	22-14-2174	38-00-1407	22-17-2172	22-17-3172	
18	22-14-2184	38-00-1408	22-17-2182	22-17-3182	
19	22-14-2194	38-00-1409	22-17-2192	22-17-3192	
20	22-14-2204	38-00-1410	22-17-2202	22-17-3202	
21	22-14-2214	38-00-1411	22-17-2212	22-17-3212	
22	22-14-2224	38-00-1412	22-17-2222	22-17-3222	
23	22-14-2234	38-00-1413	22-17-2232	22-17-3232	
24	22-14-2244	38-00-1414	22-17-2242	22-17-3242	
25	22-14-2254	38-00-1415	22-17-2252	22-17-3252	

* Current rating is dependent upon PCB traces, Copper weight, solder, etc. (contact Molex for more information)

2.54mm (.100") Pitch Single Row Custom Headers

Features and Benefits

- Sizes 2 to 36 circuits
- Optional voided pin version for polarization to the mating part available
- Optional kinked PC tail versions are available for through hole and right angle versions
- Pick-and-place cap versions available
- Tape and reel packaging option available

Reference Information

Product Specification: PS-87920-019

Packaging: Tray, tube or bag

Mates With: KK 2.54mm receptacles

Designed In: Millimeters

Electrical

Voltage: 250V

Current: 3.0A

Contact Resistance: 20 milliohms max.

Dielectric Withstanding Voltage: 500V

Insulation Resistance: 1000 Megohms min.

Physical

Housing: Glass-filled nylon, UL94V-0

Contact: Copper Alloy, 0.64mm square

Plating: Tin, Gold Flash, 10 μ " Select Gold, 15 μ " Select Gold, and 30 μ " Select Gold

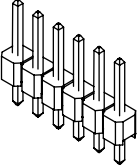
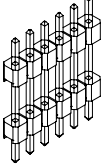
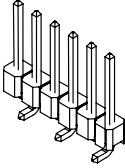
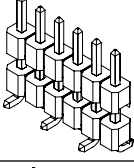
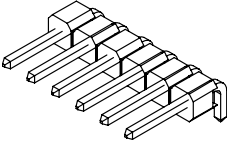
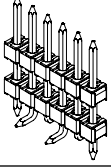
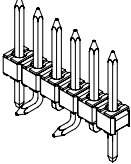
	Single Body Options	Series		Dual Body Options	Series
	Vertical Through Hole	87891		Vertical Through Hole	87937
	Vertical SMT	87898		Vertical SMT	87938
	Right Angle Through Hole	87897		Vertical SMT with Through Hole Pins	68372
	Through Hole Pins	68370			

2.54mm (.100") Pitch Dual Row Custom Headers

Features and Benefits

- Sizes 4 to 80 circuits
- Optional voided pin version for polarization to the mating part available
- Optional kinked PC tail versions are available for through hole and right angle versions
- Available with and without locating pegs
- Pick-and-place cap versions available

Reference Information

Product Specification: PS-87920-019
 Packaging: Tray, tube or bag
 Mates With: C-Grid 2.54mm Receptacles
 Designed In: Millimeters

Electrical

Voltage: 250V
 Current: 3.0A
 Contact Resistance: 20 milliohms max.
 Dielectric Withstanding Voltage: 500V
 Insulation Resistance: 1000 Megohms min.

Physical

Housing: Black high-temperature polyester, UL94V-0
 Contact: Copper Alloy, 0.64mm square
 Plating: Tin, Gold Flash, 10µ" Select Gold, 15µ" Select Gold, and 30µ" Select Gold

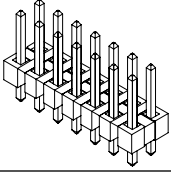
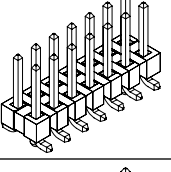
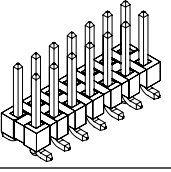
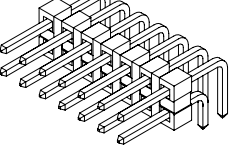
	Dual Body Options	Series
	Vertical Through Hole	87914
	Vertical SMT	87920
	Vertical SMT with pegs	87920
	Right Angle Through Hole	87911

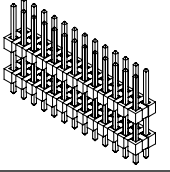
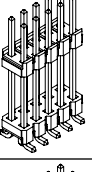
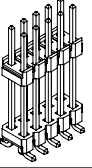
	Dual Body Options	Series
	Vertical Through Hole	87797
	Vertical SMT	87939
	Vertical SMT with pegs	87939

SMT Connectors

FFC/FPC Overview	E-2
0.25mm (.010") Pitch	
ZIF Connectors Easy-On™ Type	E-3
0.30mm (.012") Pitch	
ZIF Connectors Easy-On Type	E-3 to E-7
0.50mm (.020") Pitch	
ZIF Connectors	E-7 to E-10
ZIF Connectors Easy-On Type	E-11 to E-13
ZIF Connectors BackFlip™ Actuator	E-12
Non-ZIF Connectors	E-13
ZIF Connectors Easy-On Type for LVDS	E-14
ZIF Connectors Easy-On Dust Cover Type	E-15
1.00mm (.039") Pitch	
ZIF Connectors	E-15 to E-16
Non-ZIF Connectors	E-17 to E-18

Through Hole Connectors

1.25mm (.049") Pitch	
ZIF Connectors	E-18 to E-19
Non-ZIF Connectors	E-19 to E-20
FFC/FPC Cable Connectors — SL™	E-20 to E-22

Flat Flex Cable Jumpers—Premo-Flex™

0.50mm (.020") Pitch	E-23 to E-26
1.00mm (.039") Pitch	E-27 to E-30
1.25mm (.049") Pitch	E-31 to E-34

FFC/FPC Connectors With Actuators

Molex offers a wide variety of connectors for flat flexible cable (FFC) and flexible printed circuitry (FPC). Included in this FFC/FPC family are connectors with actuators on 0.30, 0.50, 0.625, 1.00 and 1.25mm pitch. Actuators are pre-assembled covers that secure the connection between the FFC/FPC and the connector terminals.

Features

The Actuator System offers the following advantages:

- Low wear—the Zero Insertion Force (ZIF) contacts allow for repeated cycling with minimal wear
- High strength/small size—the cover assures maximum cable retention in the smallest size
- Easy insertion—the ZIF contacts allow for the easy insertion of very thin cable

E

FFC/FPC Connectors

How the System Works

1

Raise the actuator cover and insert the FFC/FPC through the actuator cover and into the connector body.

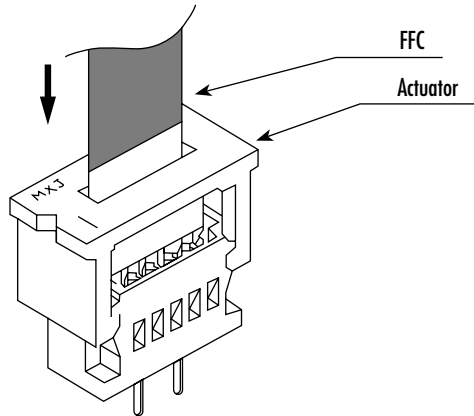

2

Press down the cover. This moves the actuating tabs against the terminals and makes a high-pressure contact between the deflected terminal and the cable contact area.

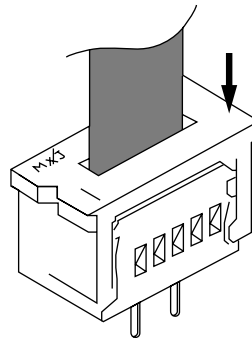

3

To disconnect the cable and connector, simply raise the cover and slip out the FFC/FPC.

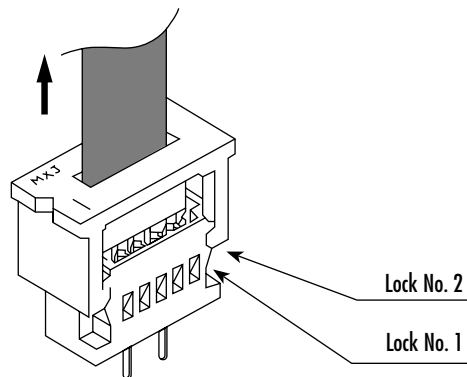

0.25mm (.010") Pitch Easy-On™ FPC Connector

502078
Right Angle, SMT
Bottom Contact Style
1.00mm (.039") Mated Height

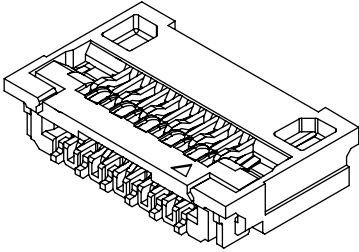

Circuits	Order No.	Lead-free
12	502078-1710	Yes
21	502078-2110	
25	502078-2510	
33	502078-3310	
39	502078-3910	
51	502078-5110	

Features and Benefits

- Sizes 17 to 51 circuits
- Easy-On actuator facilitates cable insertion
- Standard 2.0mm FPC thickness applicable

Reference Information

Product Specification: PS-502078-002
Packaging: Embossed tape
Designed In: Millimeters

Electrical

Voltage: 50V max.
Current: 0.2A max.
Contact Resistance: Odd circuits—80 milliohms max.
Even circuits—50 milliohms max.
Dielectric Withstanding Voltage: 150V AC/1 min.
Insulation Resistance: 50 Megohms min.

Physical

Housing: Glass-filled heat resistant Plastic, UL 94V-0
Actuator: Glass-filled heat resistant Plastic, UL 94-HB
Contact: Copper Alloy
Plating: Gold over Nickel
Fitting Nail: Copper Alloy, Tin over Nickel plating

0.30mm (.012") Pitch Easy-On™ BackFlip™ Type FPC Connector

502250
Right Angle, SMT
Dual Contact Style
0.90mm (.035") Mated Height

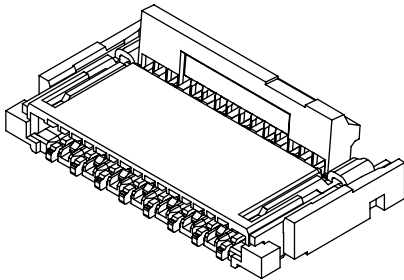

Circuits	Order No.	Lead-free
17	502250-1791	Yes
21	502250-2191	
23	502250-2391	
27	502250-2791	
33	502250-3391	

Circuits	Order No.	Lead-free
35	502250-3591	Yes
39	502250-3991	
41	502250-4191	
51	502250-5191	

Features and Benefits

- Sizes 17 to 51 circuits
- Dual contact style enables design flexibility

Reference Information

Product Specification: PS-502250-001
Packaging: Embossed tape
Designed In: Millimeters

Electrical

Voltage: 50V max.
Current: 0.2A max.
Contact Resistance: 80 milliohms max.
Dielectric Withstanding Voltage: 250V AC/1 min.
Insulation Resistance: 50 Megohms min.

Physical

Housing: Glass-filled LCP, UL 94V-0
Actuator: Glass-filled PPS, UL 94V-0
Contact: Copper Nickel Tin Alloy
Plating: Contact Area—Partial Gold over Nickel
Solder Tail Area—Partial Gold over Nickel
Fitting Nails: Phosphor Bronze, Tin over Nickel plating

0.30mm (.012") Pitch Easy-On™ BackFlip™ Type FPC Connector

501616
Right Angle, SMT
Top Contact Style
1.10mm (.043") Mated Height

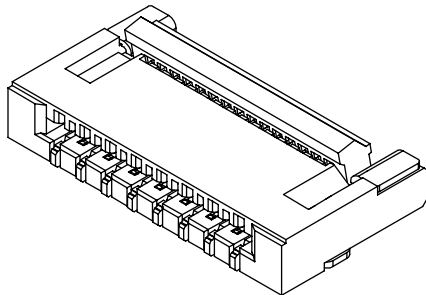

Features and Benefits

- Sizes 19 to 51 circuits
- Back-side actuator method enables easy cable insertion/extraction in very tight applications

Reference Information

Product Specification: PS-501616-002(**75)
PS-501616-003(**85)

Packaging: Embossed tape
Designed In: Millimeters

Electrical

Voltage: 50V max.
Current: 0.2A max.
Contact Resistance: 80 milliohms max.
Dielectric Withstanding Voltage: 125V AC/1 min.
Insulation Resistance: 50 Megohms min.

Physical

Housing: Gray heat resistant Polymer, UL 94V-0
Actuator: Black heat resistant Polymer, UL 94V-0
Contact: Copper Alloy
Plating: Contact Area—Partial Gold over Nickel
Solder Tail Area—Partial Gold over Nickel
Fitting Nail: Copper Alloy, Tin over Nickel plating

Circuits	Order No.	Lead-free
19	501616-1975	Yes
25	501616-2575	
27	501616-2775	
29	501616-2975	
35	501616-3585	

Circuits	Order No.	Lead-free
39	501616-3985	Yes
41	501616-4185	
45	501616-4585	
51	501616-5185	

0.30mm (.012") Pitch Easy-On™ FFC/FPC Connector

54393
Right Angle, SMT, ZIF
Bottom Contact Style

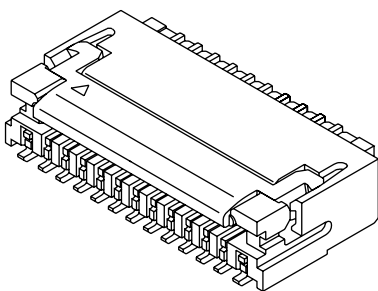

Features and Benefits

- Sizes 17 to 51 circuits
- Actuator rotates back 100 degrees for easy cable insertion
- Staggered dual-row PCB layout provides space savings and easy soldering
- Contact design includes pre-hold cable feature to help facilitate FPC insertion

Reference Information

Product Specification: PS-54393-064
Packaging: Embossed tape
Designed In: Millimeters

Electrical

Voltage: 50V max.
Current: 0.2A max.
Contact Resistance: Odd circuits—80 milliohms max.
Even circuits—40 milliohms max.
Dielectric Withstanding Voltage: 250V AC/1 min.
Insulation Resistance: 50 Megohms min.

Physical

Housing: LCP, UL 94V-0
Actuator: PPS, UL 94V-0
Contact: Phosphor Bronze
Plating: Gold over Nickel
Fitting Nail: Phosphor Bronze, Tin over Nickel Plating

Circuits	Order No.	Lead-free
17	54393-1781	Yes
21	54393-2181	
23	54393-2381	
27	54393-2781	
33	54393-3381	
39	54393-3981	
45	54393-4581	
51	54393-5181	

0.30mm (.012") Pitch Easy-On™ FPC Connector

502761
Right Angle, SMT
Bottom Contact Style
0.62mm (.024") Mated Height

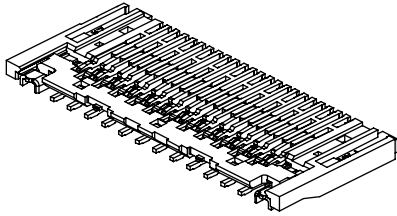

Circuits	Order No.	Lead-free
33	502761-3300	Yes
49	502761-4900	

Features and Benefits

- Sizes 33 and 49 circuits
- Ultra low profile, height 0.62mm nominal

Reference Information

Product Specification: PS-502761-001
Packaging: Embossed tape
Designed In: Millimeters

Electrical

Voltage: 50V max.
Current: 0.2A max.
Contact Resistance: 80 milliohms max.
Dielectric Withstanding Voltage: 250V AC/1 min.
Insulation Resistance: 50 Megohms min.

Physical

Housing: Glass-filled LCP, UL 94V-0
Actuator: Glass-filled LCP, UL 94V-0
Contact: Copper Nickel Tin Alloy
Plating: Contact Area—Gold over Nickel
Solder Tail Area—Gold over Nickel
Fitting Nails: Phosphor Bronze, Tin over Nickel plating

E

FFC/FPC Connectors

0.30mm (.012") Pitch Easy-On™ FPC Connector

501628
Right Angle, SMT
Bottom Contact Style
0.90mm (.035") Mated Height

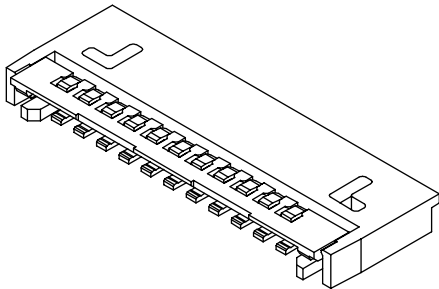

Circuits	Order No.	Lead-free
21	501628-2191	Yes
27	501628-2791	
31	501628-3191	
33	501628-3391	
35	501628-3591	
39	501628-3991	
45	501628-4591	
51	501628-5191	

Features and Benefits

- Sizes 21 to 51 circuits
- Easy-On actuator facilitates cable insertion

Reference Information

Product Specification: PS-501628-001
Packaging: Embossed tape
Designed In: Millimeters

Electrical

Voltage: 50V max.
Current: 0.2A max.
Contact Resistance: 40 milliohms max.
Dielectric Withstanding Voltage: 250V AC/1 min.
Insulation Resistance: 50 Megohms min.

Physical

Housing: Glass-filled LCP, UL 94V-0
Actuator: Glass-filled PA, UL 94V-0
Contact: Copper Alloy
Plating: Contact Area—Partial Gold over Nickel
Fitting Nail Area—Tin over Nickel

0.30mm (.012") Pitch Easy-On™ FPC Connector

54809

**Right Angle, SMT, ZIF
Bottom Contact Style
1.30mm (.051") Mated Height**

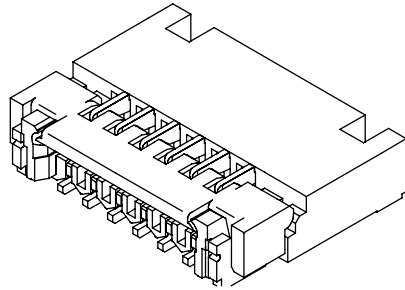

Features and Benefits

- Sizes 11 to 45 circuits
- Actuator rotates back 130 degrees for easy cable insertion
- Staggered dual-row PCB layout provides space savings and easy soldering
- Contact design includes pre-hold cable feature

Reference Information

Product Specification: PS-54809-034
Packaging: Embossed tape
Designed In: Millimeters

Electrical

Voltage: 50V max.
Current: 0.2A max.
Contact Resistance: Odd Circuits—80 milliohms max.
Even Circuits—40 milliohms max.
Dielectric Withstanding Voltage: 250V AC/1 min.
Insulation Resistance: 50 Megohms min.

Physical

Housing: LCP, UL 94V-0
Actuator: PA, UL 94V-0
Contact: Phosphor Bronze
Plating: Gold over Nickel
Fitting Nail: Phosphor Bronze, Tin over Nickel Plating

Circuits	Order No.	Lead-free
11	54809-1175	Yes
15	54809-1575	
19	54809-1975	
21	54809-2175	
25	54809-2575	
27	54809-2775	

Circuits	Order No.	Lead-free
31	54809-3175	Yes
33	54809-3375	
35	54809-3575	
39	54809-3975	
45	54809-4575	

0.30mm (.012") Pitch Easy-On™ FPC Connector

500797

**Right Angle, SMT, ZIF
Bottom Contact Style
1.05mm (.041") Mated Height**

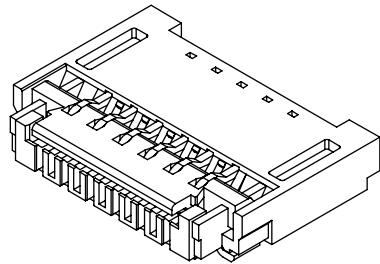

Features and Benefits

- Sizes 11 to 51 circuits
- Low profile and short width provide space savings
- Robust spring contact design
- Superior terminal design allows high retention force
- Audible click ensures cable is fully actuated

Reference Information

Product Specification: PS-500797-003
Packaging: Embossed tape
Designed In: Millimeters

Electrical

Voltage: 50V max.
Current: 0.2A max.
Contact Resistance: Odd Circuits—80 milliohms max.
Even Circuits—40 milliohms max.
Dielectric Withstanding Voltage: 250V AC/1 min.
Insulation Resistance: 50 Megohms min.

Physical

Housing: Glass-filled LCP, UL 94V-0
Actuator: Glass-filled Nylon, UL 94V-0
Contact: Copper Alloy
Plating: Gold over Nickel
Fitting Nail: Phosphor Bronze, Tin over Nickel Plating

Circuits	Order No.	Lead-free
11	500797-1194	Yes
15	500797-1594	
17	500797-1794	
23	500797-2394	
25	500797-2594	
27	500797-2794	

Circuits	Order No.	Lead-free
31	500797-3194	Yes
33	500797-3394	
35	500797-3594	
39	500797-3994	
41	500797-4194	
51	500797-5194	

0.30mm (.012") Pitch Easy-On™ FPC Connector

501912
Right Angle, SMT
Bottom Contact Style
1.80mm (.071") Mated Height

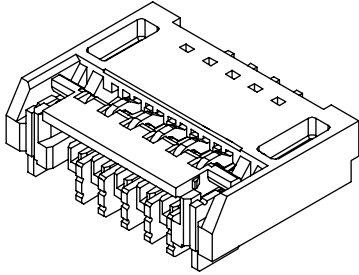

Features and Benefits

- Sizes 15 to 51 circuits
- Space under body of connector provides space for components
- LIF contact design enables temporary positioning of FPC
- Easy-On actuator for easy FPC cable insertion
- Gold plating offers good contact reliability

Reference Information

Product Specification: PS-501912-001
Packaging: Embossed tape
Designed In: Millimeters

Electrical

Voltage: 50V max.
Current: 0.2A max.
Contact Resistance: Odd circuits—80 milliohms max.
Even circuits—40 milliohms max.
Dielectric Withstanding Voltage: 250V AC/1 min.
Insulation Resistance: 50 Megohms min.

Physical

Housing: Glass-filled heat resistant Polymer, UL 94V-0
Actuator: Glass-filled heat resistant Polymer, UL 94V-0
Contact: Copper Alloy
Plating: Contact Area—Gold over Nickel
Fitting Nail Area—Tin over Nickel

Circuits	Order No.	Lead-free
15	501912-1590	Yes
21	501912-2190	
23	501912-2390	
25	501912-2590	
27	501912-2790	
33	501912-3390	
35	501912-3590	

Circuits	Order No.	Lead-free
37	501912-3790	Yes
39	501912-3990	
41	501912-4190	
45	501912-4590	
47	501912-4790	
51	501912-5190	

0.50mm (.020") Pitch FFC/FPC Connector

52559
Vertical, SMT, ZIF

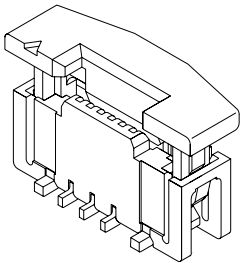

Features and Benefits

- Sizes 6 to 40 circuits
- For 0.30mm thick FFC/FPC
- Fitting nails provide PCB hold-down and strain relief for SMT tails

Reference Information

Product Specification: PS-52559-013 (XX52)
PS-52559-016 (XX54)
Packaging: Embossed tape
Designed In: Millimeters

Electrical

Voltage: 50V max.
Current: 0.5A max.
Contact Resistance: 20 milliohms max.
Dielectric Withstanding Voltage: 250V AC/1 min.
Insulation Resistance: 50 Megohms min.

Physical

Housing: Nylon, UL 94V-0
Actuator: PPS, UL 94V-0
Contact: Phosphor Bronze
Plating: Contact Area—Gold over Nickel
Solder Tail Area—Tin over Nickel
Fitting Nail: Phosphor Bronze, Tin over Nickel Plating

Circuits	Order No.		Lead-free
	Standard Packaging	High-Barrier Packaging	
6	52559-0652	52559-0654	Yes
9	52559-0952	52559-0954	
10	52559-1052	52559-1054	
12	52559-1252	52559-1254	
14	52559-1452	52559-1454	
15	52559-1552	52559-1554	
16	52559-1652	52559-1654	
20	52559-2052	52559-2054	
21	52559-2152	52559-2154	

Note: 52559-XX54 is High-Barrier (moisture protection) packaging

Circuits	Order No.		Lead-free
	Standard Packaging	High-Barrier Packaging	
24	52559-2452	52559-2454	Yes
26	52559-2652	52559-2654	
27	52559-2752	52559-2754	
28	52559-2852	52559-2854	
30	52559-3052	52559-3054	
32	52559-3252	52559-3254	
36	52559-3652	52559-3654	
40	52559-4052	52559-4054	

0.50mm (.020") Pitch FFC/FPC Connector

52745

**Right Angle, SMT, ZIF
Top Contact Style**

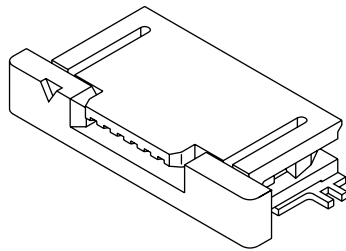

Features and Benefits

- Sizes 4 to 20 circuits
- For 0.30mm (.012") thick FFC/FPC
- Fitting nails provide PCB hold-down and strain relief for SMT tails

Reference Information

Product Specification: PS-52745-051
Packaging: Embossed tape
Designed In: Millimeters

Electrical

Voltage: 50V max.
Current: 0.5A max.
Contact Resistance: 20 milliohms max.
Dielectric Withstanding Voltage: 250V AC/1 min.
Insulation Resistance: 50 Megohms min.

Physical

Housing: Glass-filled PA, UL 94V-0
Actuator: Glass-filled PPS, UL 94V-0
Contact: Phosphor Bronze
Plating: Contact Area—Gold over Nickel
Solder Tail Area—Gold over Nickel
Fitting Nail: Phosphor Bronze, Tin over Nickel Plating

Circuits	Order No.	Lead-free
4	52745-0483	Yes
6	52745-0683	
7	52745-0783	
8	52745-0883	
10	52745-1083	
11	52745-1183	
12	52745-1283	

Circuits	Order No.	Lead-free
13	52745-1383	Yes
14	52745-1483	
15	52745-1583	
16	52745-1683	
17	52745-1783	
18	52745-1883	
20	52745-2083	

Note: High-Barrier (moisture protection) packaging

0.50mm (.020") Pitch FFC/FPC Connector

52435

**Right Angle, SMT, ZIF
Top Contact Style**

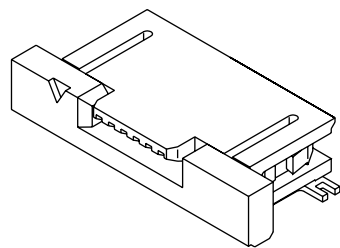

Features and Benefits

- Sizes 21 to 30 circuits
- For 0.30mm (.012") thick FFC/FPC
- Fitting nails provide PCB hold-down and strain relief for SMT tails

Reference Information

Product Specification: PS-52435-025
Packaging: Embossed tape
Designed In: Millimeters

Electrical

Voltage: 50V max.
Current: 0.5A max.
Contact Resistance: 20 milliohms max.
Dielectric Withstanding Voltage: 250V AC/1 min.
Insulation Resistance: 50 Megohms min.

Physical

Housing: Nylon, UL 94V-0
Actuator: PPS, UL 94V-0
Contact: Phosphor Bronze
Plating: Gold
Fitting Nail: Phosphor Bronze, Tin Plating

Circuits	Order No.	Lead-free
21	52435-2171	Yes
22	52435-2271	
24	52435-2471	
25	52435-2571	

Circuits	Order No.	Lead-free
26	52435-2671	Yes
27	52435-2771	
28	52435-2871	
30	52435-3071	

0.50mm (.020") Pitch FFC/FPC Connector

54104

**Right Angle, SMT, ZIF
Top Contact Style**

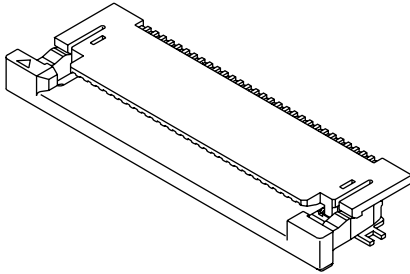

Features and Benefits

- Sizes 30 to 50 circuits
- For 0.30mm (.012") thick FFC/FPC
- Pre-hold cable feature helps facilitate correct FPC insertion
- Durable actuator design
- Fitting nails provide PCB hold-down and strain relief for SMT tails

Reference Information

Production Specification: PS-54104-071
Packaging: Embossed tape
Designed In: Millimeters

Electrical

Voltage: 50V max.
Current: 0.5A max.
Contact Resistance: 20 milliohms max.
Dielectric Withstanding Voltage: 250V AC/1 min.
Insulation Resistance: 50 Megohms min.

Physical

Housing: Nylon, UL 94V-0
Actuator: PPA, UL 94V-0
Contact: Phosphor Bronze
Plating: Gold over Nickel
Fitting Nail: Phosphor Bronze, Tin Plating

Circuits	Order No.	Lead-free
30	54104-3031	Yes
32	54104-3231	
33	54104-3331	
34	54104-3431	
35	54104-3531	
36	54104-3631	

Circuits	Order No.	Lead-free
38	54104-3831	Yes
40	54104-4031	
45	54104-4531	
46	54104-4631	
50	54104-5031	

0.50mm (.020") Pitch FFC/FPC Connector

52746

**Right Angle, SMT, ZIF
Bottom Contact Style**

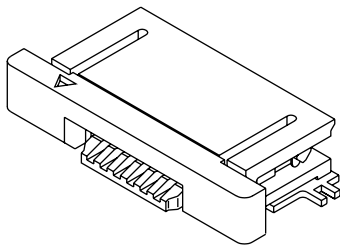

Features and Benefits

- Sizes 4 to 20 circuits
- For 0.30mm (.012") thick FFC/FPC
- Fitting nails provide PCB hold-down and strain relief for SMT tails

Reference Information

Production Specification: PS-54746-015
Packaging: Embossed tape
Designed In: Millimeters

Electrical

Voltage: 50V max.
Current: 0.5A max.
Contact Resistance: 20 milliohms max.
Dielectric Withstanding Voltage: 250V AC/1 min.
Insulation Resistance: 50 Megohms min.

Physical

Housing: Nylon, UL 94V-0
Actuator: PPS, UL 94V-0
Contact: Phosphor Bronze
Plating: Gold over Nickel
Fitting Nails: Phosphor Bronze, Tin over Nickel Plating

Circuits	Order No.	Lead-free
4	52746-0484	Yes
6	52746-0684	
7	52746-0784	
8	52746-0884	
10	52746-1084	
11	52746-1184	

Circuits	Order No.	Lead-free
12	52746-1284	Yes
14	52746-1484	
15	52746-1584	
16	52746-1684	
18	52746-1884	
20	52746-2084	

Note: High-Barrier (moisture protection) packaging

0.50mm (.020") Pitch FFC/FPC Connector

52437

**Right Angle, SMT, ZIF
Bottom Contact Style**

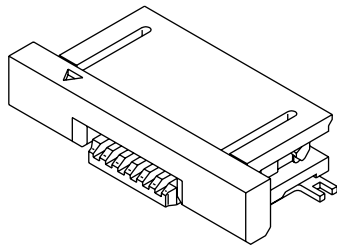

Features and Benefits

- Sizes 21 to 30 circuits
- For 0.30mm (.012") thick FFC/FPC
- Fitting nails provide PCB hold-down and strain relief for SMT tails

Reference Information

Production Specification: PS-52437-027
Packaging: Embossed tape
Designed In: Millimeters

Electrical

Voltage: 50V max.
Current: 0.5A max.
Contact Resistance: 20 milliohms max.
Dielectric Withstanding Voltage: 250V AC/1 min.
Insulation Resistance: 50 Megohms min.

Physical

Housing: Nylon, UL 94V-0
Actuator: PPS, UL 94V-0
Contact: Phosphor Bronze
Plating: Gold
Fitting Nail: Phosphor Bronze, Tin Plating

Circuits	Order No.	Lead-free
21	52437-2171	Yes
22	52437-2271	
23	52437-2371	
24	52437-2471	
25	52437-2571	

Circuits	Order No.	Lead-free
26	52437-2671	Yes
27	52437-2771	
28	52437-2871	
29	52437-2971	
30	52437-3071	

0.50mm (.020") Pitch FFC/FPC Connector

54132

**Right Angle, SMT, ZIF
Bottom Contact Style**

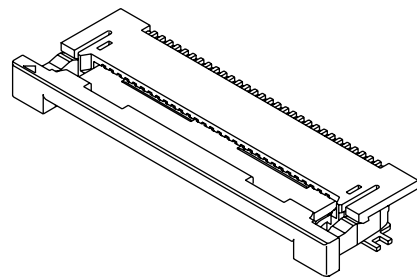

Features and Benefits

- Sizes 30 to 50 circuits
- For 0.30mm (.012") thick FFC/FPC
- Pre-hold cable retention feature helps facilitate correct FPC insertion
- Durable actuator design
- Fitting nails provide PCB hold-down and strain relief for SMT tails

Reference Information

Production Specification: PS-54132-061
Packaging: Embossed tape
Designed In: Millimeters

Electrical

Voltage: 50V max.
Current: 0.5A max.
Contact Resistance: 20 milliohms max.
Dielectric Withstanding Voltage: 250V AC/1 min.
Insulation Resistance: 50 Megohms min.

Physical

Housing: Nylon, UL 94V-0
Actuator: PPS, UL 94V-0
Contact: Phosphor Bronze
Plating: Gold over Nickel
Fitting Nails: Phosphor Bronze, Tin over Nickel plating

Circuits	Order No.	Lead-free
30	54132-3062	Yes
32	54132-3262	
33	54132-3362	
34	54132-3462	
35	54132-3562	
36	54132-3662	

Circuits	Order No.	Lead-free
38	54132-3862	Yes
40	54132-4062	
43	54132-4362	
45	54132-4562	
50	54132-5062	

0.50mm (.020") Pitch Easy-On™ FFC/FPC Connector

51296

**Right Angle, SMT, ZIF
Bottom Contact Style
1.30mm (.051") Height**

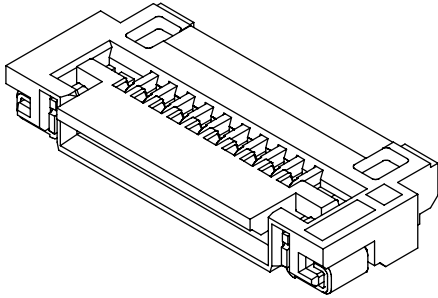

Features and Benefits

- Sizes 8 to 60 circuits
- Actuator rotates to allow for easy cable insertion from top or side
- For 0.30mm (.012") thick FFC/FPC
- Fitting nails provide PCB hold-down and strain relief for SMT tails

Reference Information

Product Specification: PS-51296-003
Packaging: Embossed tape
Designed In: Millimeters

Electrical

Voltage: 50V max.
Current: 0.5A max.
Contact Resistance: 40 milliohms max.
Dielectric Withstanding Voltage: 250V AC/1 min.
Insulation Resistance: 50 Megohms min.

Physical

Housing: Glass-filled LCP, UL 94V-0
Actuator: Glass-filled PA, UL 94V-0
Contact: Phosphor Bronze
Plating: Gold over Nickel
Fitting Nails: Phosphor Bronze, Tin over Nickel

Circuits	Order No.	Lead-free
8	51296-0894	Yes
12	51296-1294	
14	51296-1494	
18	51296-1894	
34	51296-3494	

Circuits	Order No.	Lead-free
40	51296-4094	Yes
45	51296-4594	
50	51296-5094	
54	51296-5494	
60	51296-6094	

0.50mm (.020") Pitch Easy-On™ FFC/FPC Connector

51441

**Right Angle, SMT, ZIF
Bottom Contact Style
1.10mm (.043") Mated Height**

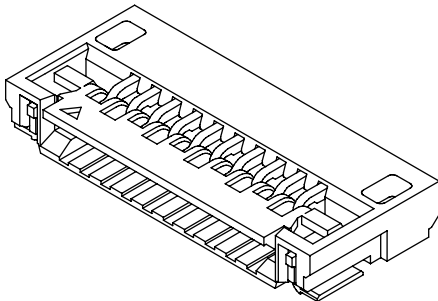

Features and Benefits

- Sizes 8 to 24 circuits
- For 0.30mm (.012") thick FFC/FPC
- Actuator rotates to allow for easy cable insertion from top or side
- Fitting nails provide PCB hold-down and strain relief for SMT tails

Reference Information

Product Specification: PS-51441-006
Packaging: Embossed tape
Designed In: Millimeters

Electrical

Voltage: 50V max.
Current: 0.5A max.
Contact Resistance: 40 milliohms max.
Dielectric Withstanding Voltage: 250V AC/1 min.
Insulation Resistance: 50 Megohms min.

Physical

Housing: Glass-filled LCP, UL 94V-0
Actuator: Glass-filled PPS, UL 94V-0
Contact: Phosphor Bronze
Plating: Gold over Nickel
Fitting Nails: Phosphor Bronze, Tin over Nickel plating

Circuits	Order No.	Lead-free
8	51441-0872	Yes
10	51441-1072	
11	51441-1172	
12	51441-1272	
20	51441-2072	
22	51441-2272	
24	51441-2472	

0.50mm (.020") Pitch Easy-On™ FPC Connector

502790

**Right Angle, SMT
Double Bottom Contact Style**

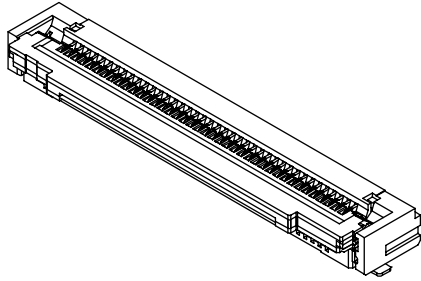

Circuits	Order No.	Lead-free
30	502790-3091	Yes
64	502790-6491	
80	502790-8091	

Features and Benefits

- Double bottom contact enables high contact reliability

Reference Information

Product Specification: PS-502790-001
Packaging: Embossed tape
Designed In: Millimeters

Electrical

Voltage: 50V max.
Current: 0.5A max.
Contact Resistance: 40 milliohms max.
Dielectric Withstanding Voltage: 125V AC/1 min.
Insulation Resistance: 50 Megohms min.

Physical

Housing: Glass-filled LCP, UL 94V-0
Actuator: Glass-filled PPS, UL 94V-0
Contact: Phosphor Bronze
Plating: Gold over Nickel
Fitting Nails: Phosphor Bronze, Tin over Nickel plating

0.50mm (.020") Pitch BackFlip™ Actuator FPC Connector

501461

**Right Angle, SMT, ZIF
Bottom Contact Style
0.80mm (.031") Mated Height**

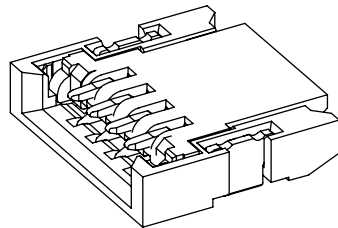

Circuits	Order No.	Lead-free
4	501461-0401	Yes
5	501461-0501	
6	501461-0601	
8	501461-0802	

Features and Benefits

- Sizes 4 to 8 circuits
- Low profile and short width provide space savings
- Two internal FPC locks allow high cable retention force
- Actuator friction locks provide secure mating
- BackFlip actuator

Reference Information

Product Specification: PS-501461-001 (4 to 6 circuits)
PS-501461-002 (8 circuits)
Packaging: Embossed tape
Designed In: Millimeters

Electrical

Voltage: 50V max.
Current: 0.3A max.
Contact Resistance: 40 milliohms max.
Dielectric Withstanding Voltage: 250V AC/1 min.
Insulation Resistance: 50 Megohms min.

Physical

Housing: Glass-filled heat resistant Polymer, UL 94V-0
Actuator: Glass-filled heat resistant Polymer, UL 94V-0
Contact: Copper Alloy
Plating: Gold over Nickel
Fitting Nail: Copper Alloy, Tin over Nickel plating

0.50mm (.020") Pitch Easy-On™ FFC/FPC Connector

501951
Vertical, SMT

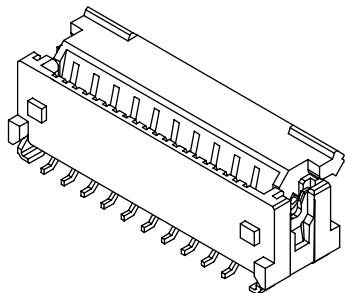

Features and Benefits

- Sizes 20 to 70 circuits
- Robust Easy-On actuator secures cable retention; easy operation
- Wide area on actuator for vacuum pick-up area
- Wide, elevated solder tabs secure PCB retention; space underneath

Reference Information

Product Specification: PS-501951-002
Packaging: Embossed tape
Designed In: Millimeters

Electrical

Voltage: 50V max.
Current: 0.4A max.
Contact Resistance: 40 milliohms max.
Dielectric Withstanding Voltage: 250V AC/1 min.
Insulation Resistance: 50 Megohms min.

Physical

Housing: Glass-filled LCP, UL 94V-0
Actuator: Glass-filled PA, UL 94V-0
Contact: Copper Alloy
Plating: Contact Area—Gold over Nickel
Fitting Nail Area—Tin over Nickel

Circuits	Order No.	Lead-free
20	501951-2010	Yes
22	501951-2210	
24	501951-2410	
30	501951-3010	
32	501951-3210	
40	501951-4010	

Circuits	Order No.	Lead-free
45	501951-4510	Yes
50	501951-5010	
60	501951-6010	
70	501951-7010	

0.50mm (.020") Pitch FFC/FPC Connector

51281
Right Angle, SMT, Non-ZIF
Dual Contact Style

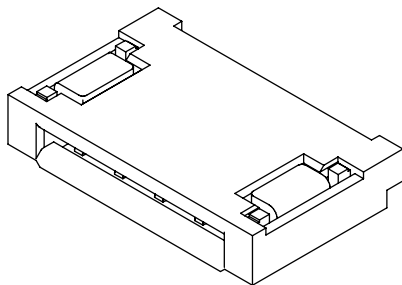

Features and Benefits

- Sizes 5 to 26 circuits
- Cable can be inserted from top or bottom
- Accepts industry standard 0.30mm (.012") thick FFC/FPC
- Low-profile design accommodates height constraints
- Surface mount solder tabs provide retention to the PCB

Reference Information

Product Specification: PS-51281-003
Packaging: Embossed tape
Designed In: Millimeters

Electrical

Voltage: 50V max.
Current: 0.5A max.
Contact Resistance: 20 milliohms max.
Dielectric Withstanding Voltage: 500V AC/1 min.
Insulation Resistance: 50 Megohms min.

Physical

Housing: Glass-filled LCP, UL 94V-0
Contact: Phosphor Bronze
Plating: Contact Area—Gold over Nickel
Solder Tail Area—Tin over Nickel
Fitting Nails: Phosphor Bronze, Tin over Nickel plating

Circuits	Order No.	Lead-free
5	51281-0594	Yes
6	51281-0694	
8	51281-0894	
9	51281-0994	
10	51281-1094	
12	51281-1294	
14	51281-1494	

Circuits	Order No.	Lead-free
16	51281-1694	Yes
18	51281-1894	
20	51281-2094	
22	51281-2294	
24	51281-2494	
26	51281-2694	

0.50mm (.020") Pitch Easy-On™ FFC Connector for LVDS

502231

Vertical, SMT, ZIF

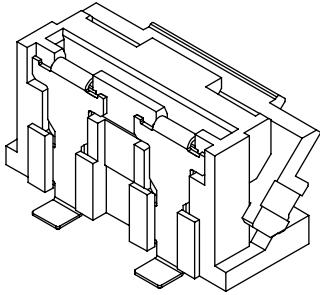

Circuits	Order No.	Lead-free
15	502231-1500	Yes
33	502231-3300	

Features and Benefits

- Sizes 15 and 33 circuits
- Grounding terminals provide noise suppression and good signal integrity
- Wide base on grounding terminals offer grounding support, PCB retention
- Easy-On actuator facilitates cable insertion
- Wide, flat actuator top provides stable pick-and-place area

Reference Information

Product Specification: PS-502231-001

Packaging: Embossed tape

Designed In: Millimeters

Electrical

Voltage: 50V max.

Current: 0.4A max.

Contact Resistance: 40 milliohms max.

Dielectric Withstanding Voltage: 250V AC/1 min.

Insulation Resistance: 50 Megohms min.

Physical

Housing: Glass-filled LCP, UL 94V-0

Actuator: Glass-filled PA, UL 94V-0

Contact: Phosphor Bronze

Plating: Contact Area—Gold over Nickel

Ground Terminal Area—Tin over Nickel

0.50mm (.020") Pitch Easy-On™ FFC Connector for LVDS

502244

Right Angle, SMT, ZIF Bottom Contact Style

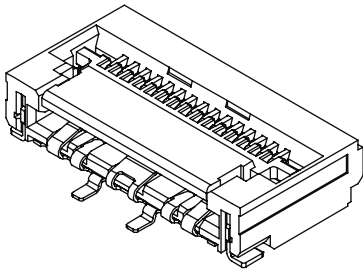

Circuits	Order No.	Lead-free
15	502244-1530	Yes
24	502244-2430	
33	502244-3330	

Features and Benefits

- Sizes 15 to 33 circuits
- Grounding terminals provide noise suppression and good signal integrity
- Wide base on grounding terminals offer grounding support, PCB retention
- Easy-On actuator facilitates cable insertion
- Wide, flat actuator top provides stable pick-and-place area

Reference Information

Product Specification: PS-502244-001

Packaging: Embossed tape

Designed In: Millimeters

Electrical

Voltage: 50V max.

Current: 0.4A max.

Contact Resistance: 40 milliohms max.

Dielectric Withstanding Voltage: 250V AC/1 min.

Insulation Resistance: 50 Megohms min.

Physical

Housing: Glass-filled LCP, UL 94V-0

Actuator: Glass-filled PA, UL 94V-0

Contact: Phosphor Bronze

Plating: Contact Area—Gold over Nickel

Ground Terminal Area—Tin over Nickel

Fitting Nails: Phosphor Bronze, Tin over Nickel Plating

0.50mm (.020") Pitch
Easy-On™
FPC Connector
Dust Cover type
502611
Right Angle, SMT
Bottom Contact Style
3.90mm (.154") Mated Height

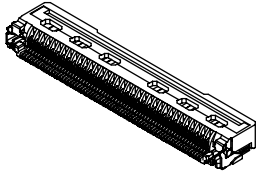

Features and Benefits

- Sizes 20 to 68 circuits
- Dust cover type
- Large actuator on back side prevents dust insertion

Reference Information

Product Specification: PS-502611-002
 Packaging: Embossed tape
 Designed In: Millimeters

Electrical

Voltage: 100V max.
 Current: 0.3A max.
 Contact Resistance: 100 milliohms max.
 Dielectric Withstanding Voltage: 100V AC/1 min.
 Insulation Resistance: 50 Megohms min.

Physical

Housing: Glass-filled heat resistant Polymer, UL 94V-0
 Actuator: Glass-filled heat resistant Polymer, UL 94V-0
 Contact: Copper Alloy
 Plating: Partial Gold over Nickel
 Fitting Nails: Copper Alloy, Tin plating

Circuits	Order No.	Lead-free
20	502611-2021	Yes
35	502611-3521	
55	502611-5521	
68	502611-6821	

1.00mm (.039") Pitch
FFC/FPC Connector
52610
Vertical, SMT, ZIF

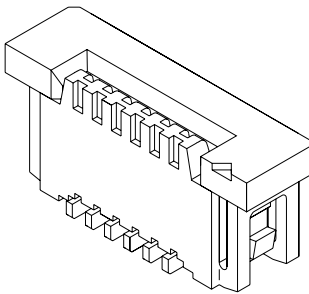

Features and Benefits

- Sizes 6 to 30 circuits
- For 0.30mm thick FFC/FPC

Reference Information

Product Specification: PS-52610-007
 UL File No.: E29179
 Packaging: Embossed tape
 Designed In: Millimeters

Electrical

Voltage: 125V max.
 Current: 1.0A max.
 Contact Resistance: 20 milliohms max.
 Dielectric Withstanding Voltage: 500V AC/1 min.
 Insulation Resistance: 100 Megohms min.

Physical

Housing: Nylon, UL 94V-0
 Actuator: PPS, UL 94V-0
 Contact: Phosphor Bronze
 Plating: Contact Area—Gold over Nickel
 Solder Tail Area—Tin over Nickel

Circuits	Order No.		Lead-free
	Standard Packaging	High-Barrier Packaging	
6	52610-0672	52610-0677	Yes
8	52610-0872	52610-0877	
9	52610-0972	52610-0977	
10	52610-1072	52610-1077	
12	52610-1272	52610-1277	
14	52610-1472	52610-1477	
15	52610-1572	52610-1577	
16	52610-1672	52610-1677	

Note: 52610-XX77 is High-Barrier (moisture protection) packaging

Circuits	Order No.		Lead-free
	Standard Packaging	High-Barrier Packaging	
17	52610-1772	52610-1777	Yes
18	52610-1872	52610-1877	
20	52610-2072	52610-2077	
22	52610-2272	52610-2277	
24	52610-2472	52610-2477	
26	52610-2672	52610-2677	
30	52610-3072	52610-3077	

1.00mm (.039") Pitch FFC/FPC Connector

52207

**Right Angle, SMT, ZIF
Top Contact Style**

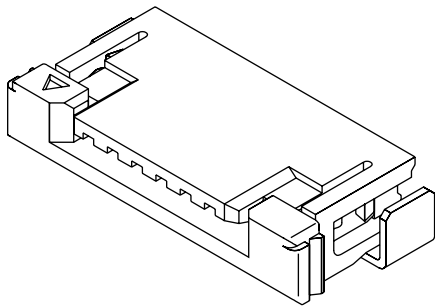

Features and Benefits

- Sizes 3 to 30 circuits
- For 0.30mm thick FFC/FPC
- Fitting nails provide PCB hold-down and strain relief for SMT tails

Reference Information

Product Specification: PS-52207-048
 Packaging: Embossed tape
 UL File No.: E29179
 CSA File No.: LR19980
 Designed In: Millimeters

Electrical

Voltage: 125V max.
 Current: 1.0A max.
 Contact Resistance: 20 milliohms max.
 Dielectric Withstanding Voltage: 500V AC/1 min.
 Insulation Resistance: 100 Megohms min.

Physical

Housing: Nylon, UL 94V-0
 Actuator: PPS, UL 94V-0
 Contact: Phosphor Bronze
 Plating: Contact Area—Gold over Nickel
 Solder Tail Area—Tin over Nickel
 Fitting Nail: Copper Alloy, Tin over Nickel plating

Circuits	Order No.		Lead-free
	Standard Packaging	High-Barrier Packaging	
3	52207-0360	52207-0351	Yes
4	52207-0460	52207-0451	
5	52207-0560	52207-0551	
6	52207-0660	52207-0651	
7	52207-0760	52207-0751	
8	52207-0860	52207-0851	
9	52207-0960	52207-0951	
10	52207-1060	52207-1051	

Circuits	Order No.		Lead-free
	Standard Packaging	High-Barrier Packaging	
11	52207-1160	52207-1151	Yes
12	52207-1260	52207-1251	
13	52207-1360	52207-1351	
14	52207-1460	52207-1451	
15	52207-1560	52207-1551	
16	52207-1660	52207-1651	
18	52207-1860	52207-1851	
19	52207-1960	52207-1951	

Circuits	Order No.		Lead-free
	Standard Packaging	High-Barrier Packaging	
20	52207-2060	52207-2051	Yes
21	52207-2160	52207-2151	
22	52207-2260	52207-2251	
24	52207-2460	52207-2451	
26	52207-2660	52207-2651	
27	52207-2760		
28	52207-2860	52207-2851	
30	52207-3060	52207-3051	

Note: 52207-XX51 is High-Barrier (moisture protection) packaging

1.00mm (.039") Pitch FFC/FPC Connector

52271

**Right Angle, SMT, ZIF
Bottom Contact Style**

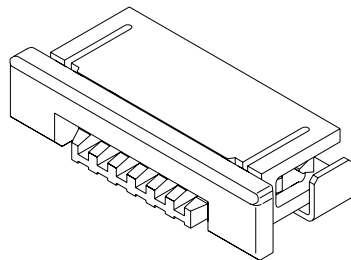

Features and Benefits

- Sizes 5 to 30 circuits
- For 0.30mm thick FFC/FPC
- Fitting nails provide PCB hold-down and strain relief for SMT tails

Reference Information

Product Specification: PS-52271-054
 Packaging: Embossed tape
 UL File No.: E29179
 CSA File No.: LR19980
 Designed In: Millimeters

Electrical

Voltage: 50V max.
 Current: 0.5A max.
 Contact Resistance: 20 milliohms max.
 Dielectric Withstanding Voltage: 500V AC/1 min.
 Insulation Resistance: 100 Megohms min.

Physical

Housing: Nylon, UL 94V-0
 Actuator: PPS, UL 94V-0
 Contact: Phosphor Bronze
 Plating: Contact Area—Gold over Nickel
 Solder Tail Area—Tin over Nickel
 Fitting Nail: Copper Alloy, Tin over Nickel plating

Circuits	Order No.		Lead-free
	Standard Packaging	High-Barrier Packaging	
5	52271-0569	52271-0583	Yes
7	52271-0769	52271-0783	
8	52271-0869	52271-0883	
10	52271-1069	52271-1083	
12	52271-1269	52271-1283	
13	52271-1369	52271-1383	
14	52271-1469	52271-1483	
15	52271-1569	52271-1583	
16	52271-1669	52271-1683	

Circuits	Order No.		Lead-free
	Standard Packaging	High-Barrier Packaging	
17	52271-1769	52271-1783	Yes
18	52271-1869	52271-1883	
20	52271-2069	52271-2083	
21	52271-2169	52271-2183	
22	52271-2269	52271-2283	
25	52271-2569	52271-2583	
27	52271-2769	52271-2783	
28	52271-2869		
30	52271-3069	52271-3083	

Note: 52271-XX83 is High-Barrier (moisture protection) packaging

1.00mm (.039") Pitch FFC/FPC Connector

52808

Vertical, SMT, Non-ZIF

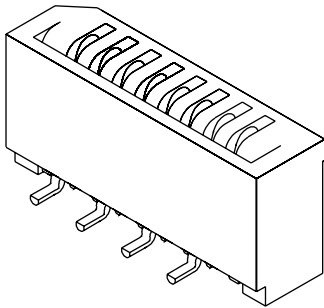

Features and Benefits

- Sizes 4 to 30 circuits

Reference Information

Product Specification: PS-52808-004
Packaging: Embossed tape
Designed In: Millimeters

Electrical

Voltage: 125V max.
Current: 0.5A max.
Contact Resistance: 30 milliohms max.
Dielectric Withstanding Voltage: 500V AC/1 min.
Insulation Resistance: 100 Megohms min.

Physical

Housing: PPS, UL 94V-0
Contact: Phosphor Bronze
Plating: Tin Bismuth over Nickel

Circuits	Order No.	Lead-free
4	52808-0470	Yes
5	52808-0570	
6	52808-0670	
7	52808-0770	
8	52808-0870	
9	52808-0970	
10	52808-1070	
11	52808-1170	
12	52808-1270	

Circuits	Order No.	Lead-free
13	52808-1370	Yes
14	52808-1470	
15	52808-1570	
16	52808-1670	
17	52808-1770	
18	52808-1870	
19	52808-1970	
20	52808-2070	
21	52808-2170	

Circuits	Order No.	Lead-free
22	52808-2270	Yes
23	52808-2370	
24	52808-2470	
25	52808-2570	
26	52808-2670	
27	52808-2770	
28	52808-2870	
29	52808-2970	
30	52808-3070	

1.00mm (.039") Pitch FFC/FPC Connector

52793

**Right Angle, SMT, Non-ZIF
Top Contact Style**

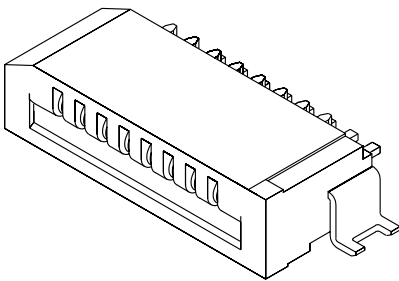

Features and Benefits

- Sizes 4 to 30 circuits
- For 0.30mm thick FFC/FPC
- Fitting nails provide PCB hold-down and strain relief for SMT tails

Reference Information

Product Specification: PS-52793-014
Packaging: Embossed tape
Designed In: Millimeters

Electrical

Voltage: 50V max.
Current: 0.5A max.
Contact Resistance: 30 milliohms max.
Dielectric Withstanding Voltage: 500V AC/1 min.
Insulation Resistance: 100 Megohms min.

Physical

Housing: PPS, UL 94V-0
Contact: Phosphor Bronze
Plating: Tin Bismuth over Nickel
Fitting Nail: Phosphor Bronze, Tin over Nickel plating

Circuits	Order No.	Lead-free
4	52793-0470	Yes
5	52793-0570	
6	52793-0670	
7	52793-0770	
8	52793-0870	
9	52793-0970	
10	52793-1070	
11	52793-1170	
12	52793-1270	

Circuits	Order No.	Lead-free
13	52793-1370	Yes
14	52793-1470	
15	52793-1570	
16	52793-1670	
17	52793-1770	
18	52793-1870	
19	52793-1970	
20	52793-2070	
21	52793-2170	

Circuits	Order No.	Lead-free
22	52793-2270	Yes
23	52793-2370	
24	52793-2470	
25	52793-2570	
26	52793-2670	
27	52793-2770	
28	52793-2870	
29	52793-2970	
30	52793-3070	

1.00mm (.039") Pitch FFC/FPC Connector

52852

**Right Angle, SMT, Non-ZIF
Bottom Contact Style**

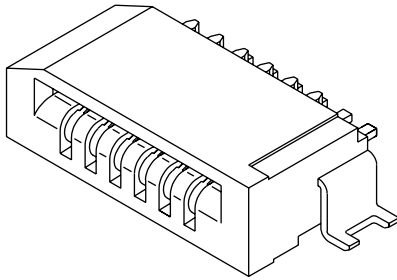

Features and Benefits

- Sizes 4 to 30 circuits
- For 0.30mm thick FFC/FPC
- Fitting nails provide PCB hold-down and strain relief for SMT tails

Reference Information

Product Specification: PS-52852-014
Packaging: Embossed tape
Designed In: Millimeters

Electrical

Voltage: 50V max.
Current: 0.5A max.
Contact Resistance: 20 milliohms max.
Dielectric Withstanding Voltage: 500V AC/1 min.
Insulation Resistance: 50 Megohms min.

Physical

Housing: PPS, UL 94V-0
Contact: Phosphor Bronze
Plating: Tin Bismuth over Nickel
Fitting Nail: Phosphor Bronze, Tin over Nickel plating

Circuits	Order No.	Lead-free
4	52852-0470	Yes
5	52852-0570	
6	52852-0670	
7	52852-0770	
8	52852-0870	
9	52852-0970	
10	52852-1070	
11	52852-1170	
12	52852-1270	

Circuits	Order No.	Lead-free
13	52852-1370	Yes
14	52852-1470	
15	52852-1570	
16	52852-1670	
18	52852-1870	
19	52852-1970	
20	52852-2070	
22	52852-2270	
23	52852-2370	

Circuits	Order No.	Lead-free
24	52852-2470	Yes
25	52852-2570	
26	52852-2670	
27	52852-2770	
28	52852-2870	
29	52852-2970	
30	52852-3070	

1.25mm (.049") Pitch FFC/FPC Connector

5597-NCPB7F

Vertical, ZIF

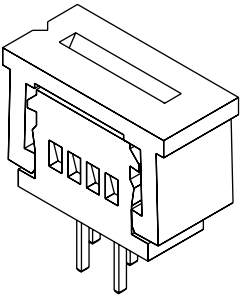

Features and Benefits

- Sizes 3 to 30 circuits
- Staggered solder tails, 3.50mm (.138") long
- 5597 accommodates FFC/FPC 0.30mm (.012") thick

Reference Information

Product Specification: PS-5597-004
Packaging: Tray
UL File No.: E29179
Designed In: Millimeters

Electrical

Voltage: 2V max.
Current: 1.0A max.
Contact Resistance: 20 milliohms max.
Dielectric Withstanding Voltage: 500V AC/1 min.
Insulation Resistance: 500 Megohms min.

Physical

Housing: PBTP, UL 94V-0
Actuator: PBTP, UL 94V-0
Contact: Phosphor Bronze
Plating: Tin Bismuth over Nickel

Circuits	Order No.	Lead-free
3	39-53-2035	Yes
4	39-53-2045	
5	39-53-2055	
6	39-53-2065	
7	39-53-2075	
8	39-53-2085	
9	39-53-2095	
10	39-53-2105	
11	39-53-2115	
12	39-53-2125	

Circuits	Order No.	Lead-free
13	39-53-2135	Yes
14	39-53-2145	
15	39-53-2155	
16	39-53-2165	
17	39-53-2175	
18	39-53-2185	
19	39-53-2195	
20	39-53-2205	
21	39-53-2215	
22	39-53-2225	

Circuits	Order No.	Lead-free
23	39-53-2235	Yes
24	39-53-2245	
25	39-53-2255	
26	39-53-2265	
27	39-53-2275	
28	39-53-2285	
29	39-53-2295	
30	39-53-2305	

1.25mm (.049") Pitch FFC/FPC Connector

52045

Vertical, Non-ZIF

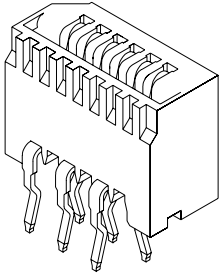

Features and Benefits

- Sizes 3 to 40 circuits
- For 0.30mm thick FFC/FPC
- All solder tails kinked for added PCB retention

Reference Information

Product Specification: PS-52045-001
 Packaging: Tray
 UL File No.: E29179
 Designed In: Millimeters

Electrical

Voltage: 200V max.
 Current: 1.0A max.
 Contact Resistance: 30 milliohms max.
 Dielectric Withstanding Voltage: 500V AC/1 min.
 Insulation Resistance: 500 Megohms min.

Physical

Housing: PBTP, UL 94V-0
 Contact: Phosphor Bronze
 Plating: Tin

Circuits	Order No.	Lead-free
3	52045-0345	Yes
4	52045-0445	
5	52045-0545	
6	52045-0645	
7	52045-0745	
8	52045-0845	
9	52045-0945	
10	52045-1045	
11	52045-1145	
12	52045-1245	
13	52045-1345	
14	52045-1445	
15	52045-1545	

Circuits	Order No.	Lead-free
16	52045-1645	Yes
17	52045-1745	
18	52045-1845	
19	52045-1945	
20	52045-2045	
21	52045-2145	
22	52045-2245	
23	52045-2345	
24	52045-2445	
25	52045-2545	
26	52045-2645	
27	52045-2745	
28	52045-2845	

Circuits	Order No.	Lead-free
29	52045-2945	Yes
30	52045-3045	
31	52045-3145	
32	52045-3245	
33	52045-3345	
34	52045-3445	
35	52045-3545	
36	52045-3645	
37	52045-3745	
38	52045-3845	
39	52045-3945	
40	52045-4045	

1.25mm (.049") Pitch FFC/FPC Connector

5597-NAPB7F

Right Angle, ZIF

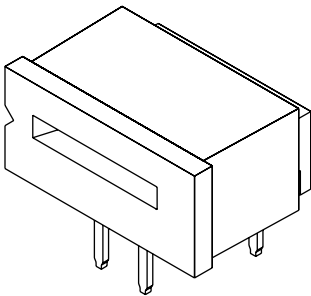

Features and Benefits

- Sizes 3 to 30 circuits
- Staggered solder tails, 3.50mm (.138") long
- 5597 accommodates FFC/FPC 0.30mm (.012") thick

Reference Information

Product Specification: PS-5597-004
 Packaging: Tray
 UL File No.: E29179
 Designed In: Millimeters

Electrical

Voltage: 2V max.
 Current: 1.0A max.
 Contact Resistance: 20 milliohms max.
 Dielectric Withstanding Voltage: 500V AC/1 min.
 Insulation Resistance: 500 Megohms min.

Physical

Housing: PBTP, UL 94V-0
 Actuator: PBTP, UL 94V-0
 Contact: Phosphor Bronze
 Plating: Tin Bismuth over Nickel

Circuits	Order No.	Lead-free
3	39-53-2034	Yes
4	39-53-2044	
5	39-53-2054	
6	39-53-2064	
7	39-53-2074	
8	39-53-2084	
9	39-53-2094	
10	39-53-2104	
11	39-53-2114	
12	39-53-2124	

Circuits	Order No.	Lead-free
13	39-53-2134	Yes
14	39-53-2144	
15	39-53-2154	
16	39-53-2164	
17	39-53-2174	
18	39-53-2184	
19	39-53-2194	
20	39-53-2204	
21	39-53-2214	
22	39-53-2224	

Circuits	Order No.	Lead-free
23	39-53-2234	Yes
24	39-53-2244	
25	39-53-2254	
26	39-53-2264	
27	39-53-2274	
28	39-53-2284	
29	39-53-2294	
30	39-53-2304	

1.25mm (.049") Pitch FFC/FPC Connector

52044

**Right Angle, Non-ZIF
Top Contact Style**

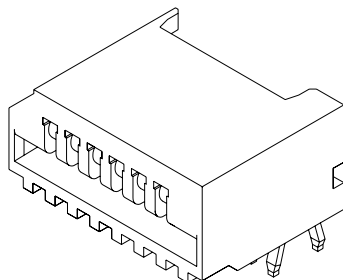

Features and Benefits

- Sizes 3 to 40 circuits
- For 0.30mm thick FFC/FPC
- All solder tails kinked for added PCB retention

Reference Information

Product Specification: PS-52044-002
Packaging: Tray
UL File No.: E29179
Designed In: Millimeters

Electrical

Voltage: 200V max.
Current: 1.0A max.
Contact Resistance: 30 milliohms max.
Dielectric Withstanding Voltage: 500V AC/1 min.
Insulation Resistance: 500 Megohms min.

Physical

Housing: PBTP, UL 94V-0
Contact: Phosphor Bronze
Plating: Tin

www.molex.com/product/ffc/

Circuits	Order No.	Lead-free
3	52044-0345	Yes
4	52044-0445	
5	52044-0545	
6	52044-0645	
7	52044-0745	
8	52044-0845	
9	52044-0945	
10	52044-1045	
11	52044-1145	
12	52044-1245	
13	52044-1345	
14	52044-1445	
15	52044-1545	

Circuits	Order No.	Lead-free
16	52044-1645	Yes
17	52044-1745	
18	52044-1845	
19	52044-1945	
20	52044-2045	
21	52044-2145	
22	52044-2245	
23	52044-2345	
24	52044-2445	
25	52044-2545	
26	52044-2645	
27	52044-2745	
28	52044-2845	

Circuits	Order No.	Lead-free
29	52044-2945	Yes
30	52044-3045	
31	52044-3145	
32	52044-3245	
33	52044-3345	
34	52044-3445	
35	52044-3545	
36	52044-3645	
37	52044-3745	
38	52044-3845	
39	52044-3945	
40	52044-4045	

2.54mm (.100") Pitch SL™ FFC/FPC Connector

70430

**Single Row, Female
Version A**

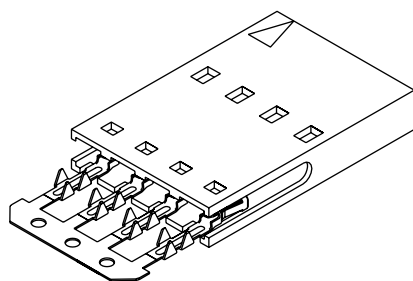

Features and Benefits

- Sizes 2 to 25 circuits
- Stackable end-to-end and side-by-side
- Piercing crimp provides 3 high-pressure interfaces with the conductor
- Terminals preloaded into housing

Reference Information

Product Specification: PS-70430
Packaging: Tube
UL File No.: E29179
CSA File No.: LR19980
Mates With: 2.54mm (.100") pitch, single or dual row headers (C-Grid®, SL, KK®)
Designed In: Inches

Electrical

Voltage: 250V
Current: 2.0A (for Copper conductors)
Contact Resistance: 10 milliohms max.
Dielectric Withstanding Voltage: 1500V
Insulation Resistance: 1000 Megohms min.

Mechanical

Contact Retention to Housing: 13.34N (3 lb) min.
Mating Force: 2.22N (.50 lb) max.
Unmating Force: 0.28N (.06 lb) min.
Wire Pull-Out Force: 26.69N (6 lb)
Durability: Tin—25 cycles; Gold—50 cycles

Physical

Housing: Black polyester, UL 94V-0
Contact: Copper Alloy
Plating: See Table

Circuits	Order No.			Lead-free
	150µm Tin	15µm Gold	30µm Gold	
2	15-38-8028	15-47-4020	15-47-4024	Yes
3	15-38-8038	15-47-4030	15-47-4034	
4	15-38-8048	15-47-4040	15-47-4044	
5	15-38-8058	15-47-4050	15-47-4054	
6	15-38-8068	15-47-4060	15-47-4064	
7	15-38-8078	15-47-4070	15-47-4074	
8	15-38-8088	15-47-4080	15-47-4084	
9	15-38-8098	15-47-4090	15-47-4094	
10	15-38-8108	15-47-4100	15-47-4104	
11	15-38-8118	15-47-4110	15-47-4114	
12	15-38-8128	15-47-4120	15-47-4124	
13	15-38-8138	15-47-4130	15-47-4134	

Circuits	Order No.			Lead-free
	150µm Tin	15µm Gold	30µm Gold	
14	15-38-8148	15-47-4140	15-47-4144	Yes
15	15-38-8158	15-47-4150	15-47-4154	
16	15-38-8168	15-47-4160	15-47-4164	
17	15-38-8178	15-47-4170	15-47-4174	
18	15-38-8188	15-47-4180	15-47-4184	
19	15-38-8198	15-47-4190	15-47-4194	
20	15-38-8208	15-47-4200	15-47-4204	
21	15-38-8218	15-47-4210	15-47-4214	
22	15-38-8228	15-47-4220	15-47-4224	
23	15-38-8238	15-47-4230	15-47-4234	
24	15-38-8248	15-47-4240	15-47-4244	
25	15-38-8258	15-47-4250	15-47-4254	

2.54mm (.100") Pitch SL™ FFC/FPC Connector

70430 Single Row, Female Version C

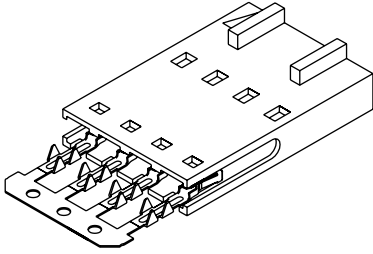

Features and Benefits

- Sizes 2 to 25 circuits
- Front polarizing ribs prevent pin damage during disconnect, housing cannot be twisted off pins
- Piercing crimp provides 3 high-pressure interfaces with the conductor
- Terminals preloaded into housing

Reference Information

Product Specification: PS-70430
Packaging: Tube
UL File No.: E29179
CSA File No.: LR19980
Mates With: 2.54mm (.100") SL headers
Designed In: Inches

Electrical

Voltage: 250V
Current: 2.0A (for Copper conductors)
Contact Resistance: 10 milliohms max.
Dielectric Withstanding Voltage: 1500V
Insulation Resistance: 1000 Megohms min.

Mechanical

Contact Retention to Housing: 13.34N (3 lb) min.
Mating Force: 2.22N (.50 lb) max.
Unmating Force: 0.28N (.06 lb) min.
Wire Pull-Out Force: 26.69N (6 lb)
Durability: Tin—25 cycles; Gold—50 cycles

Physical

Housing: Black polyester, UL 94V-0
Contact: Copper Alloy
Plating: See Table

Circuits	Order No.			Lead-free
	150µm Tin	15µm Gold	30µm Gold	
2	15-38-8027	15-47-4021	15-47-4025	Yes
3	15-38-8037	15-47-4031	15-47-4035	
4	15-38-8047	15-47-4041	15-47-4045	
5	15-38-8057	15-47-4051	15-47-4055	
6	15-38-8067	15-47-4061	15-47-4065	
7	15-38-8077	15-47-4071	15-47-4075	
8	15-38-8087	15-47-4081	15-47-4085	
9	15-38-8097	15-47-4091	15-47-4095	
10	15-38-8107	15-47-4101	15-47-4105	
11	15-38-8117	15-47-4111	15-47-4115	
12	15-38-8127	15-47-4121	15-47-4125	
13	15-38-8137	15-47-4131	15-47-4135	

Circuits	Order No.			Lead-free
	150µm Tin	15µm Gold	30µm Gold	
14	15-38-8147	15-47-4141	15-47-4145	Yes
15	15-38-8157	15-47-4151	15-47-4155	
16	15-38-8167	15-47-4161	15-47-4165	
17	15-38-8177	15-47-4171	15-47-4175	
18	15-38-8187	15-47-4181	15-47-4185	
19	15-38-8197	15-47-4191	15-47-4195	
20	15-38-8207	15-47-4201	15-47-4205	
21	15-38-8217	15-47-4211	15-47-4215	
22	15-38-8227	15-47-4221	15-47-4225	
23	15-38-8237	15-47-4231	15-47-4235	
24	15-38-8247	15-47-4241	15-47-4245	
25	15-38-8257	15-47-4251	15-47-4255	

2.54mm (.100") Pitch SL™ FFC/FPC Connector

70430 Single Row, Female Version D

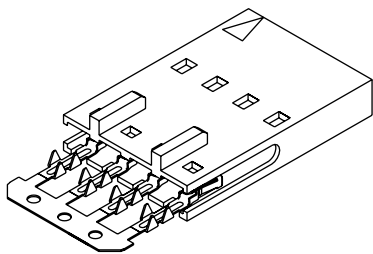

Features and Benefits

- Sizes 2 to 25 circuits
- Designed for use within interim clips and panel mount connectors to form a larger single mating connector
- Stackable end-to-end and back-to-back
- Back polarizing ribs prevent the assembly from drifting within the interim clip when another module is removed
- Piercing crimp provides 3 high-pressure interfaces with the conductor
- Terminals preloaded into housing

Reference Information

Product Specification: PS-70430
Packaging: Tube
UL File No.: E29179
CSA File No.: LR19980
Accessories: Interim clips 70004 and 70013 to form female connector assembly
Mates With: 70021 male crimp terminals, 70400 and 70430 connector assemblies and 0.64mm (.025") square pins
Designed In: Inches

Electrical

Voltage: 250V
Current: 2.0A (for Copper conductors)
Contact Resistance: 10 milliohms max.
Dielectric Withstanding Voltage: 1500V
Insulation Resistance: 1000 Megohms min.

Mechanical

Contact Retention to Housing: 13.34N (3 lb) min.
Mating Force: 2.22N (.50 lb) max.
Unmating Force: 0.28N (.06 lb) min.
Wire Pull-Out Force: 26.69N (6 lb)
Durability: Tin—25 cycles; Gold—50 cycles

Physical

Housing: Black polyester, UL 94V-0
Contact: Copper Alloy
Plating: See Table

Circuits	Order No.			Lead-free
	150µm Tin	15µm Gold	30µm Gold	
2	15-38-8029	15-47-4022	15-47-4026	Yes
3	15-38-8039	15-47-4032	15-47-4036	
4	15-38-8049	15-47-4042	15-47-4046	
5	15-38-8059	15-47-4052	15-47-4056	
6	15-38-8069	15-47-4062	15-47-4066	
7	15-38-8079	15-47-4072	15-47-4076	
8	15-38-8089	15-47-4082	15-47-4086	
9	15-38-8099	15-47-4092	15-47-4096	
10	15-38-8109	15-47-4102	15-47-4106	
11	15-38-8119	15-47-4112	15-47-4116	
12	15-38-8129	15-47-4122	15-47-4126	
13	15-38-8139	15-47-4132	15-47-4136	

Circuits	Order No.			Lead-free
	150µm Tin	15µm Gold	30µm Gold	
14	15-38-8149	15-47-4142	15-47-4146	Yes
15	15-38-8159	15-47-4152	15-47-4156	
16	15-38-8169	15-47-4162	15-47-4166	
17	15-38-8179	15-47-4172	15-47-4176	
18	15-38-8189	15-47-4182	15-47-4186	
19	15-38-8199	15-47-4192	15-47-4196	
20	15-38-8209	15-47-4202	15-47-4206	
21	15-38-8219	15-47-4212	15-47-4216	
22	15-38-8229	15-47-4222	15-47-4226	
23	15-38-8239	15-47-4232	15-47-4236	
24	15-38-8249	15-47-4242	15-47-4246	
25	15-38-8259	15-47-4252	15-47-4256	

2.54mm (.100") Pitch SL™ FFC/FPC Connector

70430 Single Row, Female Version G

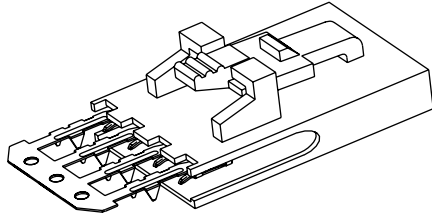

Features and Benefits

- Sizes 2 to 25 circuits
- Positive latch locks connector to header or panel mount
- Piercing crimp provides 3 high-pressure interfaces with the conductor
- Terminals preloaded into housing

Reference Information

Product Specification: PS-70430
 Packaging: Tube
 UL File No.: E29179
 CSA File No.: LR19980
 Mates With: 70018, 70107A/B, 70541, 70543, 70545, 70551, 70553, 70555, 70634 and 74099
 Designed In: Inches

Electrical

Voltage: 250V
 Current: 2.0A (for Copper conductors)
 Contact Resistance: 10 milliohms max.
 Dielectric Withstanding Voltage: 1500V
 Insulation Resistance: 1000 Megohms min.

Mechanical

Contact Retention to Housing: 13.34N (3 lb) min.
 Mating Force: 2.22N (.50 lb) max.
 Unmating Force: 0.28N (.06 lb) min.
 Wire Pull-Out Force: 26.69N (6 lb)
 Durability: Tin—25 cycles; Gold—50 cycles

Physical

Housing: Black polyester, UL 94V-0
 Contact: Copper Alloy
 Plating: See Table

Circuits	Order No.			Lead-free
	150µm Tin	15µm Gold	30µm Gold	
2	15-38-8020	15-47-4023	15-47-4027	Yes
3	15-38-8030	15-47-4033	15-47-4037	
4	15-38-8040	15-47-4043	15-47-4047	
5	15-38-8050	15-47-4053	15-47-4057	
6	15-38-8060	15-47-4063	15-47-4067	
7	15-38-8070	15-47-4073	15-47-4077	
8	15-38-8080	15-47-4083	15-47-4087	
9	15-38-8090	15-47-4093	15-47-4097	
10	15-38-8100	15-47-4103	15-47-4107	
11	15-38-8110	15-47-4113	15-47-4117	
12	15-38-8120	15-47-4123	15-47-4127	
13	15-38-8130	15-47-4133	15-47-4137	

Circuits	Order No.			Lead-free
	150µm Tin	15µm Gold	30µm Gold	
14	15-38-8140	15-47-4143	15-47-4147	Yes
15	15-38-8150	15-47-4153	15-47-4157	
16	15-38-8160	15-47-4163	15-47-4167	
17	15-38-8170	15-47-4173	15-47-4177	
18	15-38-8180	15-47-4183	15-47-4187	
19	15-38-8190	15-47-4193	15-47-4197	
20	15-38-8200	15-47-4203	15-47-4207	
21	15-38-8210	15-47-4213	15-47-4217	
22	15-38-8220	15-47-4223	15-47-4227	
23	15-38-8230	15-47-4233	15-47-4237	
24	15-38-8240	15-47-4243	15-47-4247	
25	15-38-8250	15-47-4253	15-47-4257	

2.54mm (.100") Pitch SL™ FFC/FPC Connector

70431 Single Row, Male Version D

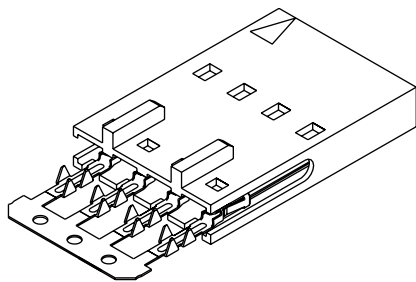

Features and Benefits

- Sizes 2 to 25 circuits
- Stackable end-to-end and back-to-back
- Back ribs prevent movement when used within panel mount housings
- Piercing crimp provides 3 high-pressure interfaces with the conductor
- Terminals preloaded into housing

Reference Information

Product Specification: PS-70431
 Packaging: Tube
 UL File No.: E29179
 CSA File No.: LR19980
 Accessories: Panel mount connectors 70018, 70022 and 70104 to form a male pin assembly
 Mates With: 70058 and 71851 female crimp terminals, 70400 and 70430 connector assemblies and 0.64mm (.025") square pins
 Designed In: Inches

Electrical

Voltage: 250V
 Current: 2.0A (for Copper conductors)
 Contact Resistance: 10 milliohms max.
 Dielectric Withstanding Voltage: 1500V
 Insulation Resistance: 1000 Megohms min.

Mechanical

Wire Pull-Out Force: 26.69N (6 lb)
 Mating Force: 2.22N (.50 lb) max.
 Unmating Force: 0.28N (.06 lb) min.
 Durability: Tin—25 cycles; Gold—50 cycles

Physical

Housing: Black polyester, UL 94V-0
 Contact: Copper Alloy
 Plating: See Table

Circuits	Order No.		
	15µm Gold	30µm Gold	150µm Tin
2	15-47-5020	15-47-5024	15-38-9022
3	15-47-5030	15-47-5034	15-38-9032
4	15-47-5040	15-47-5044	15-38-9042
5	15-47-5050	15-47-5054	15-38-9052
6	15-47-5060	15-47-5064	15-38-9062
7	15-47-5070	15-47-5074	15-38-9072
8	15-47-5080	15-47-5084	15-38-9082
9	15-47-5090	15-47-5094	15-38-9092
10	15-47-5100	15-47-5104	15-38-9102
11	15-47-5110	15-47-5114	15-38-9112
12	15-47-5120	15-47-5124	15-38-9122
13	15-47-5130	15-47-5134	15-38-9132

Circuits	Order No.		
	15µm Gold	30µm Gold	150µm Tin
14	15-47-5140	15-47-5144	15-38-9142
15	15-47-5150	15-47-5154	15-38-9152
16	15-47-5160	15-47-5164	15-38-9162
17	15-47-5170	15-47-5174	15-38-9172
18	15-47-5180	15-47-5184	15-38-9182
19	15-47-5190	15-47-5194	15-38-9192
20	15-47-5200	15-47-5204	15-38-9202
21	15-47-5210	15-47-5214	15-38-9212
22	15-47-5220	15-47-5224	15-38-9222
23	15-47-5230	15-47-5234	15-38-9232
24	15-47-5240	15-47-5244	15-38-9242
25	15-47-5250	15-47-5254	15-38-9252

0.50mm (.020") Pitch Premo-Flex™ Flat Flex Cable Jumpers

21020
Standard

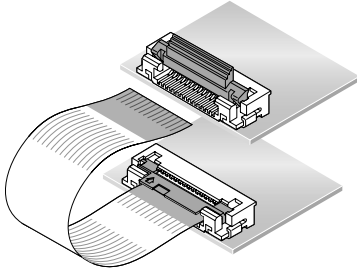

Molex introduces a complete line of 0.50mm (.020") pitch Flat Flex Cable jumpers. These jumpers are used to connect 2 PC boards and terminate to either ZIF or Non-ZIF FFC Connectors.

Molex 0.50mm (.020") Flat Flex Cable jumpers are available in a wide variety of lengths and circuit sizes. These standard lengths are easy to order and feature shorter lead times.

Reference Information

UL Style No.: 2896
Mates With: Any 0.50mm (.020") pitch Molex FFC/FPC connector
Designed In: Millimeters

Electrical
Voltage: 30V
Current: 0.5A

Physical
Strip Length: 4.0mm (.157")
Reinforcement Length: 6.00mm (.236")
Width: (N + 1) 0.50mm
Span: (N - 1) 0.50mm
Margin: 0.35mm (.014")
Conductor Width: 0.30mm (.012")
Conductor Thickness: 0.10mm (.004")
End Thickness: 0.30 ± 0.05mm (.012 ± .002")

Type A FFC Jumpers—Contacts on same side (Preferred version in North America)

Circuits	Order No.											Lead-free
	Overall Length											
	30.00mm (1.181")	51.00mm (2.00")	76.00mm (3.00")	102.00mm (4.00")	127.00mm (5.00")	152.00mm (6.00")	178.00mm (7.00")	203.00mm (8.00")	229.00mm (9.00")	254.00mm (10.00")	305.00mm (12.00")	
6	21020-0051	21020-0053	21020-0055	21020-0057	21020-0059	21020-0061	21020-0063	21020-0065	21020-0067	21020-0069	21020-0071	
7	21020-0745	21020-0747	21020-0749	21020-0751	21020-0753	21020-0755	21020-0757	21020-0759	21020-0761	21020-0763	21020-0765	
8	21020-0073	21020-0075	21020-0077	21020-0079	21020-0081	21020-0083	21020-0085	21020-0087	21020-0089	21020-0091	21020-0093	
9	21020-0767	21020-0769	21020-0771	21020-0773	21020-0775	21020-0777	21020-0779	21020-0781	21020-0783	21020-0785	21020-0787	
10	21020-0095	21020-0097	21020-0099	21020-0101	21020-0103	21020-0105	21020-0107	21020-0109	21020-0111	21020-0113	21020-0115	
11	21020-0789	21020-0791	21020-0793	21020-0795	21020-0797	21020-0799	21020-0801	21020-0803	21020-0805	21020-0807	21020-0809	
12	21020-0117	21020-0119	21020-0121	21020-0123	21020-0125	21020-0127	21020-0129	21020-0131	21020-0133	21020-0135	21020-0137	
13	21020-0811	21020-0813	21020-0815	21020-0817	21020-0819	21020-0821	21020-0823	21020-0825	21020-0827	21020-0829	21020-0831	
14	21020-0139	21020-0141	21020-0143	21020-0145	21020-0147	21020-0149	21020-0151	21020-0153	21020-0155	21020-0157	21020-0159	
15	21020-0833	21020-0835	21020-0837	21020-0839	21020-0841	21020-0843	21020-0845	21020-0847	21020-0849	21020-0851	21020-0853	
16	21020-0161	21020-0163	21020-0165	21020-0167	21020-0169	21020-0171	21020-0173	21020-0175	21020-0177	21020-0179	21020-0181	
17	21020-0855	21020-0857	21020-0859	21020-0861	21020-0863	21020-0865	21020-0867	21020-0869	21020-0871	21020-0873	21020-0875	
18	21020-0183	21020-0185	21020-0187	21020-0189	21020-0191	21020-0193	21020-0195	21020-0197	21020-0199	21020-0201	21020-0203	
19	21020-0877	21020-0879	21020-0881	21020-0883	21020-0885	21020-0887	21020-0889	21020-0891	21020-0893	21020-0895	21020-0897	
20	21020-0205	21020-0207	21020-0209	21020-0211	21020-0213	21020-0215	21020-0217	21020-0219	21020-0221	21020-0223	21020-0225	
21	21020-0899	21020-0901	21020-0903	21020-0905	21020-0907	21020-0909	21020-0911	21020-0913	21020-0915	21020-0917	21020-0919	
22	21020-0227	21020-0229	21020-0231	21020-0233	21020-0235	21020-0237	21020-0239	21020-0241	21020-0243	21020-0245	21020-0247	
23	21020-0921	21020-0923	21020-0925	21020-0927	21020-0929	21020-0931	21020-0933	21020-0935	21020-0937	21020-0939	21020-0941	Yes
24	21020-0249	21020-0251	21020-0253	21020-0255	21020-0257	21020-0259	21020-0261	21020-0263	21020-0265	21020-0267	21020-0269	
25	21020-0943	21020-0945	21020-0947	21020-0949	21020-0951	21020-0953	21020-0955	21020-0957	21020-0959	21020-0961	21020-0963	
26	21020-0271	21020-0273	21020-0275	21020-0277	21020-0279	21020-0281	21020-0283	21020-0285	21020-0287	21020-0289	21020-0291	
27	21020-0965	21020-0967	21020-0969	21020-0971	21020-0973	21020-0975	21020-0977	21020-0979	21020-0981	21020-0983	21020-0985	
28	21020-0293	21020-0295	21020-0297	21020-0299	21020-0301	21020-0303	21020-0305	21020-0307	21020-0309	21020-0311	21020-0313	
29	21020-0987	21020-0989	21020-0991	21020-0993	21020-0995	21020-0997	21020-0999	21020-1001	21020-1003	21020-1005	21020-1007	
30	21020-0315	21020-0317	21020-0319	21020-0321	21020-0323	21020-0325	21020-0327	21020-0329	21020-0331	21020-0333	21020-0335	
31	21020-1009	21020-1011	21020-1013	21020-1015	21020-1017	21020-1019	21020-1021	21020-1023	21020-1025	21020-1027	21020-1029	
32	21020-0337	21020-0339	21020-0341	21020-0343	21020-0345	21020-0347	21020-0349	21020-0351	21020-0353	21020-0355	21020-0357	
33	21020-1031	21020-1033	21020-1035	21020-1037	21020-1039	21020-1041	21020-1043	21020-1045	21020-1047	21020-1049	21020-1051	
34	21020-0359	21020-0361	21020-0363	21020-0365	21020-0367	21020-0369	21020-0371	21020-0373	21020-0375	21020-0377	21020-0379	
35	21020-1053	21020-1055	21020-1057	21020-1059	21020-1061	21020-1063	21020-1065	21020-1067	21020-1069	21020-1071	21020-1073	
36	21020-0381	21020-0383	21020-0385	21020-0387	21020-0389	21020-0391	21020-0393	21020-0395	21020-0397	21020-0399	21020-0401	
37	21020-1075	21020-1077	21020-1079	21020-1081	21020-1083	21020-1085	21020-1087	21020-1089	21020-1091	21020-1093	21020-1095	
38	21020-0403	21020-0405	21020-0407	21020-0409	21020-0411	21020-0413	21020-0415	21020-0417	21020-0419	21020-0421	21020-0423	
39	21020-1097	21020-1099	21020-1101	21020-1103	21020-1105	21020-1107	21020-1109	21020-1111	21020-1113	21020-1115	21020-1117	
40	21020-0425	21020-0427	21020-0429	21020-0431	21020-0433	21020-0435	21020-0437	21020-0439	21020-0441	21020-0443	21020-0445	

Custom jumpers available

0.50mm (.020") Pitch Premo-Flex™ Flat Flex Cable Jumpers

21020 Standard

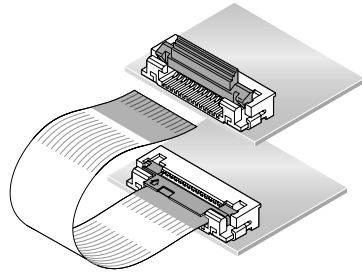

Molex introduces a complete line of 0.50mm (.020") pitch Flat Flex Cable jumpers. These jumpers are used to connect 2 PC boards and terminate to either ZIF or Non-ZIF FFC Connectors.

Molex 0.50mm (.020") Flat Flex Cable jumpers are available in a wide variety of lengths and circuit sizes. These standard lengths are easy to order and feature shorter lead times.

Reference Information

UL Style No.: 2896

Mates With: Any 0.50mm (.020") pitch Molex FFC/FPC connector

Designed In: Millimeters

Electrical

Voltage: 30V

Current: 0.5A

Physical

Strip Length: 4.0mm (.157")

Reinforcement Length: 6.00mm (.236")

Width: (N + 1) 0.50mm

Span: (N - 1) 0.50mm

Margin: 0.35mm (.014")

Conductor Width: 0.30mm (.012")

Conductor Thickness: 0.10mm (.004")

End Thickness: 0.30 ± 0.05mm (.012 ± .002")

Type D FFC Jumpers—Contacts on opposite sides (Preferred version in North America)

Circuits	Order No.											Lead-free
	Overall Length											
	30.00mm (1.181")	51.00mm (2.00")	76.00mm (3.00")	102.00mm (4.00")	127.00mm (5.00")	152.00mm (6.00")	178.00mm (7.00")	203.00mm (8.00")	229.00mm (9.00")	254.00mm (10.00")	305.00mm (12.00")	
6	21020-0052	21020-0054	21020-0056	21020-0058	21020-0060	21020-0062	21020-0064	21020-0066	21020-0068	21020-0070	21020-0072	
7	21020-0744	21020-0746	21020-0748	21020-0750	21020-0752	21020-0754	21020-0756	21020-0758	21020-0760	21020-0762	21020-0764	
8	21020-0074	21020-0076	21020-0078	21020-0080	21020-0082	21020-0084	21020-0086	21020-0088	21020-0090	21020-0092	21020-0094	
9	21020-0766	21020-0768	21020-0770	21020-0772	21020-0774	21020-0776	21020-0778	21020-0780	21020-0782	21020-0784	21020-0786	
10	21020-0096	21020-0098	21020-0100	21020-0102	21020-0104	21020-0106	21020-0108	21020-0110	21020-0112	21020-0114	21020-0116	
11	21020-0788	21020-0790	21020-0792	21020-0794	21020-0796	21020-0798	21020-0800	21020-0802	21020-0804	21020-0806	21020-0808	
12	21020-0118	21020-0120	21020-0122	21020-0124	21020-0126	21020-0128	21020-0130	21020-0132	21020-0134	21020-0136	21020-0138	
13	21020-0810	21020-0812	21020-0814	21020-0816	21020-0818	21020-0820	21020-0822	21020-0824	21020-0826	21020-0828	21020-0830	
14	21020-0140	21020-0142	21020-0144	21020-0146	21020-0148	21020-0150	21020-0152	21020-0154	21020-0156	21020-0158	21020-0160	
15	21020-0832	21020-0834	21020-0836	21020-0838	21020-0840	21020-0842	21020-0844	21020-0846	21020-0848	21020-0850	21020-0852	
16	21020-0162	21020-0164	21020-0166	21020-0168	21020-0170	21020-0172	21020-0174	21020-0176	21020-0178	21020-0180	21020-0182	
17	21020-0854	21020-0856	21020-0858	21020-0860	21020-0862	21020-0864	21020-0866	21020-0868	21020-0870	21020-0872	21020-0874	
18	21020-0184	21020-0186	21020-0188	21020-0190	21020-0192	21020-0194	21020-0196	21020-0198	21020-0200	21020-0202	21020-0204	
19	21020-0876	21020-0878	21020-0880	21020-0882	21020-0884	21020-0886	21020-0888	21020-0890	21020-0892	21020-0894	21020-0896	
20	21020-0206	21020-0208	21020-0210	21020-0212	21020-0214	21020-0216	21020-0218	21020-0220	21020-0222	21020-0224	21020-0226	
21	21020-0898	21020-0900	21020-0902	21020-0904	21020-0906	21020-0908	21020-0910	21020-0912	21020-0914	21020-0916	21020-0918	
22	21020-0228	21020-0230	21020-0232	21020-0234	21020-0236	21020-0238	21020-0240	21020-0242	21020-0244	21020-0246	21020-0248	
23	21020-0920	21020-0922	21020-0924	21020-0926	21020-0928	21020-0930	21020-0932	21020-0934	21020-0936	21020-0938	21020-0940	Yes
24	21020-0250	21020-0252	21020-0254	21020-0256	21020-0258	21020-0260	21020-0262	21020-0264	21020-0266	21020-0268	21020-0270	
25	21020-0942	21020-0944	21020-0946	21020-0948	21020-0950	21020-0952	21020-0954	21020-0956	21020-0958	21020-0960	21020-0962	
26	21020-0272	21020-0274	21020-0276	21020-0278	21020-0280	21020-0282	21020-0284	21020-0286	21020-0288	21020-0290	21020-0292	
27	21020-0964	21020-0966	21020-0968	21020-0970	21020-0972	21020-0974	21020-0976	21020-0978	21020-0980	21020-0982	21020-0984	
28	21020-0294	21020-0296	21020-0298	21020-0300	21020-0302	21020-0304	21020-0306	21020-0308	21020-0310	21020-0312	21020-0314	
29	21020-0986	21020-0988	21020-0990	21020-0992	21020-0994	21020-0996	21020-0998	21020-1000	21020-1002	21020-1004	21020-1006	
30	21020-0316	21020-0318	21020-0320	21020-0322	21020-0324	21020-0326	21020-0328	21020-0330	21020-0332	21020-0334	21020-0336	
31	21020-1008	21020-1010	21020-1012	21020-1014	21020-1016	21020-1018	21020-1020	21020-1022	21020-1024	21020-1026	21020-1028	
32	21020-0338	21020-0340	21020-0342	21020-0344	21020-0346	21020-0348	21020-0350	21020-0352	21020-0354	21020-0356	21020-0358	
33	21020-1030	21020-1032	21020-1034	21020-1036	21020-1038	21020-1040	21020-1042	21020-1044	21020-1046	21020-1048	21020-1050	
34	21020-0360	21020-0362	21020-0364	21020-0366	21020-0368	21020-0370	21020-0372	21020-0374	21020-0376	21020-0378	21020-0380	
35	21020-1052	21020-1054	21020-1056	21020-1058	21020-1060	21020-1062	21020-1064	21020-1066	21020-1068	21020-1070	21020-1072	
36	21020-0382	21020-0384	21020-0386	21020-0388	21020-0390	21020-0392	21020-0394	21020-0396	21020-0398	21020-0400	21020-0402	
37	21020-1074	21020-1076	21020-1078	21020-1080	21020-1082	21020-1084	21020-1086	21020-1088	21020-1090	21020-1092	21020-1094	
38	21020-0404	21020-0406	21020-0408	21020-0410	21020-0412	21020-0414	21020-0416	21020-0418	21020-0420	21020-0422	21020-0424	
39	21020-1096	21020-1098	21020-1100	21020-1102	21020-1104	21020-1106	21020-1108	21020-1110	21020-1112	21020-1114	21020-1116	
40	21020-0426	21020-0428	21020-0430	21020-0432	21020-0434	21020-0436	21020-0438	21020-0440	21020-0442	21020-0444	21020-0446	

Custom jumpers available

0.50mm (.020") Pitch Premo-Flex™ Flat Flex Cable Jumpers

98266
Standard

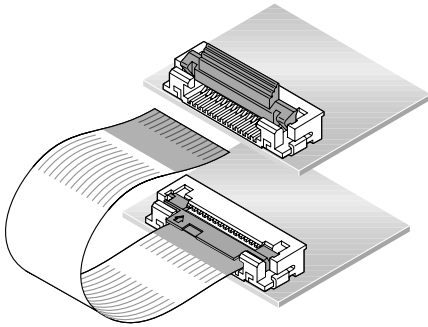

Molex introduces a complete line of 0.50mm (.020") pitch Flat Flex Cable jumpers. These jumpers are used to connect 2 PC boards and terminate to either ZIF or Non-ZIF FFC connectors.

Molex 0.50mm (.020") Flat Flex Cable jumpers are available in a wide variety of lengths and circuit sizes. These standard lengths are easy to order and feature shorter lead times.

We are also able to offer customized lengths and circuit sizes.

Reference Information

Product Specification: PS-98266-001

Packaging: Box

UL Style No.: 20706

Mates With: Any 0.50mm (.020") pitch Molex FFC/FPC connector
Designed In: Millimeters

Electrical

Voltage: 60V

Current: 0.5A

Physical

Strip Length: 4.0mm (.157")

Reinforcement Length: 8.0mm (.315")

Width: (N + 1) 0.50mm

Span: (N - 1) 0.50mm

Margin: 0.35mm (.014")

Conductor Width: 0.30mm (.012")

Conductor Thickness: 0.10mm (.004")

End Thickness: 0.30 ± 0.05mm (.012 ± .002")

Type A Jumpers—Contacts on same side (Preferred version in Europe)

Circuits	Order No.											Lead-free
	Overall Length											
	30mm (1.181")	5 mm (2.00")	76mm (3.00")	102mm (4.00")	127mm (5.00")	152mm (6.00")	178mm (7.00")	203mm (8.00")	229mm (9.00")	254mm (10.00")	305mm (12.00")	
6	98266-0051	98266-0053	98266-0055	98266-0057	98266-0059	98266-0061	98266-0063	98266-0065	98266-0067	98266-0069	98266-0071	
7	98266-0745	98266-0747	98266-0749	98266-0751	98266-0753	98266-0755	98266-0757	98266-0759	98266-0761	98266-0763	98266-0765	
8	98266-0073	98266-0075	98266-0077	98266-0079	98266-0081	98266-0083	98266-0085	98266-0087	98266-0089	98266-0091	98266-0093	
9	98266-0767	98266-0769	98266-0771	98266-0773	98266-0775	98266-0777	98266-0779	98266-0781	98266-0783	98266-0785	98266-0787	
10	98266-0095	98266-0097	98266-0099	98266-0101	98266-0103	98266-0105	98266-0107	98266-0109	98266-0111	98266-0113	98266-0115	
11	98266-0789	98266-0791	98266-0793	98266-0795	98266-0797	98266-0799	98266-0801	98266-0803	98266-0805	98266-0807	98266-0809	
12	98266-0117	98266-0119	98266-0121	98266-0123	98266-0125	98266-0127	98266-0129	98266-0131	98266-0133	98266-0135	98266-0137	
13	98266-0811	98266-0813	98266-0815	98266-0817	98266-0819	98266-0821	98266-0823	98266-0825	98266-0827	98266-0829	98266-0831	
14	98266-0139	98266-0141	98266-0143	98266-0145	98266-0147	98266-0149	98266-0151	98266-0153	98266-0155	98266-0157	98266-0159	
15	98266-0833	98266-0835	98266-0837	98266-0839	98266-0841	98266-0843	98266-0845	98266-0847	98266-0849	98266-0851	98266-0853	
16	98266-0161	98266-0163	98266-0165	98266-0167	98266-0169	98266-0171	98266-0173	98266-0175	98266-0177	98266-0179	98266-0181	
17	98266-0855	98266-0857	98266-0859	98266-0861	98266-0863	98266-0865	98266-0867	98266-0869	98266-0871	98266-0873	98266-0875	
18	98266-0183	98266-0185	98266-0187	98266-0189	98266-0191	98266-0193	98266-0195	98266-0197	98266-0199	98266-0201	98266-0203	
19	98266-0877	98266-0879	98266-0881	98266-0883	98266-0885	98266-0887	98266-0889	98266-0891	98266-0893	98266-0895	98266-0897	
20	98266-0205	98266-0207	98266-0209	98266-0211	98266-0213	98266-0215	98266-0217	98266-0219	98266-0221	98266-0223	98266-0225	
21	98266-0899	98266-0901	98266-0903	98266-0905	98266-0907	98266-0909	98266-0911	98266-0913	98266-0915	98266-0917	98266-0919	
22	98266-0227	98266-0229	98266-0231	98266-0233	98266-0235	98266-0237	98266-0239	98266-0241	98266-0243	98266-0245	98266-0247	
23	98266-0921	98266-0923	98266-0925	98266-0927	98266-0929	98266-0931	98266-0933	98266-0935	98266-0937	98266-0939	98266-0941	
24	98266-0249	98266-0251	98266-0253	98266-0255	98266-0257	98266-0259	98266-0261	98266-0263	98266-0265	98266-0267	98266-0269	
25	98266-0943	98266-0945	98266-0947	98266-0949	98266-0951	98266-0953	98266-0955	98266-0957	98266-0959	98266-0961	98266-0963	
26	98266-0271	98266-0273	98266-0275	98266-0277	98266-0279	98266-0281	98266-0283	98266-0285	98266-0287	98266-0289	98266-0291	
27	98266-0965	98266-0967	98266-0969	98266-0971	98266-0973	98266-0975	98266-0977	98266-0979	98266-0981	98266-0983	98266-0985	
28	98266-0293	98266-0295	98266-0297	98266-0299	98266-0301	98266-0303	98266-0305	98266-0307	98266-0309	98266-0311	98266-0313	
29	98266-0987	98266-0989	98266-0991	98266-0993	98266-0995	98266-0997	98266-0999	98266-1001	98266-1003	98266-1005	98266-1007	
30	98266-0315	98266-0317	98266-0319	98266-0321	98266-0323	98266-0325	98266-0327	98266-0329	98266-0331	98266-0333	98266-0335	
31	98266-1009	98266-1011	98266-1013	98266-1015	98266-1017	98266-1019	98266-1021	98266-1023	98266-1025	98266-1027	98266-1029	
32	98266-0337	98266-0339	98266-0341	98266-0343	98266-0345	98266-0347	98266-0349	98266-0351	98266-0353	98266-0355	98266-0357	
33	98266-1031	98266-1033	98266-1035	98266-1037	98266-1039	98266-1041	98266-1043	98266-1045	98266-1047	98266-1049	98266-1051	
34	98266-0359	98266-0361	98266-0363	98266-0365	98266-0367	98266-0369	98266-0371	98266-0373	98266-0375	98266-0377	98266-0379	
35	98266-1053	98266-1055	98266-1057	98266-1059	98266-1061	98266-1063	98266-1065	98266-1067	98266-1069	98266-1071	98266-1073	
36	98266-0381	98266-0383	98266-0385	98266-0387	98266-0389	98266-0391	98266-0393	98266-0395	98266-0397	98266-0399	98266-0401	
37	98266-1075	98266-1077	98266-1079	98266-1081	98266-1083	98266-1085	98266-1087	98266-1089	98266-1091	98266-1093	98266-1095	
38	98266-0403	98266-0405	98266-0407	98266-0409	98266-0411	98266-0413	98266-0415	98266-0417	98266-0419	98266-0421	98266-0423	
39	98266-1097	98266-1099	98266-1101	98266-1103	98266-1105	98266-1107	98266-1109	98266-1111	98266-1113	98266-1115	98266-1117	
40	98266-0425	98266-0427	98266-0429	98266-0431	98266-0433	98266-0435	98266-0437	98266-0439	98266-0441	98266-0443	98266-0445	
41	98266-1119	98266-1121	98266-1123	98266-1125	98266-1127	98266-1129	98266-1131	98266-1133	98266-1135	98266-1137	98266-1139	
42	98266-0447	98266-0449	98266-0451	98266-0453	98266-0455	98266-0457	98266-0459	98266-0461	98266-0463	98266-0465	98266-0467	
43	98266-1141	98266-1143	98266-1145	98266-1147	98266-1149	98266-1151	98266-1153	98266-1155	98266-1157	98266-1159	98266-1161	
44	98266-0469	98266-0471	98266-0473	98266-0475	98266-0477	98266-0479	98266-0481	98266-0483	98266-0485	98266-0487	98266-0489	
45	98266-1163	98266-1165	98266-1167	98266-1169	98266-1171	98266-1173	98266-1175	98266-1177	98266-1179	98266-1181	98266-1183	
46	98266-0491	98266-0493	98266-0495	98266-0497	98266-0499	98266-0501	98266-0503	98266-0505	98266-0507	98266-0509	98266-0511	
47	98266-1185	98266-1187	98266-1189	98266-1191	98266-1193	98266-1195	98266-1197	98266-1199	98266-1201	98266-1203	98266-1205	
48	98266-0513	98266-0515	98266-0517	98266-0519	98266-0521	98266-0523	98266-0525	98266-0527	98266-0529	98266-0531	98266-0533	
49	98266-1207	98266-1209	98266-1211	98266-1213	98266-1215	98266-1217	98266-1219	98266-1221	98266-1223	98266-1225	98266-1227	
50	98266-0535	98266-0537	98266-0539	98266-0541	98266-0543	98266-0545	98266-0547	98266-0549	98266-0551	98266-0553	98266-0555	

E

FFC/FPC Connectors

0.50mm (.020") Pitch Premo-Flex™ Flat Flex Cable Jumpers

98266
Standard

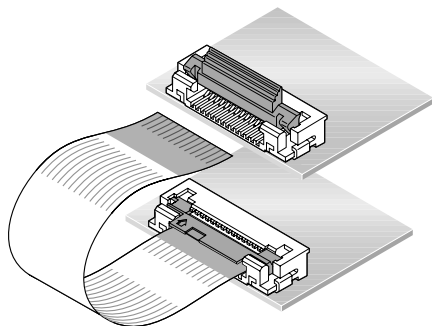

Molex introduces a complete line of 0.50mm (.020") pitch Flat Flex Cable jumpers. These jumpers are used to connect 2 PC boards and terminate to either ZIF or Non-ZIF FFC connectors.

Molex 0.50mm (.020") Flat Flex Cable jumpers are available in a wide variety of lengths and circuit sizes. These standard lengths are easy to order and feature shorter lead times.

We are also able to offer customized lengths and circuit sizes.

Reference Information

Product Specification: PS-98266-001

Packaging: Box

UL Style No.: 20706

Mates With: Any 0.50mm (.020") Pitch Molex FFC/FPC connector

Designed In: Millimeters

Electrical
Voltage: 60V
Current: 0.5A

Physical
Strip Length: 4.0mm (.157")
Reinforcement Length: 8.0mm (.315")
Width: (N + 1) 0.50mm
Span: (N - 1) 0.50mm
Margin: 0.35mm (.014")
Conductor Width: 0.30mm (.012")
Conductor Thickness: 0.10mm (.004")
End Thickness: 0.30 ± 0.05mm (.012 ± .002")

Type D Jumpers—Contacts on opposite sides (Preferred version in Europe)

Circuits	Order No.											Lead-free
	Overall Length											
	30 mm (1.181")	51 mm (2.00")	76mm (3.00")	102mm (4.00")	127mm (5.00")	152mm (6.00")	178mm (7.00")	203mm (8.00")	229mm (9.00")	254mm (10.00")	305mm (12.00")	
6	98266-0052	98266-0054	98266-0056	98266-0058	98266-0060	98266-0062	98266-0064	98266-0066	98266-0068	98266-0070	98266-0072	
7	98266-0744	98266-0746	98266-0748	98266-0750	98266-0752	98266-0754	98266-0756	98266-0758	98266-0760	98266-0762	98266-0764	
8	98266-0074	98266-0076	98266-0078	98266-0080	98266-0082	98266-0084	98266-0086	98266-0088	98266-0090	98266-0092	98266-0094	
9	98266-0766	98266-0768	98266-0770	98266-0772	98266-0774	98266-0776	98266-0778	98266-0780	98266-0782	98266-0784	98266-0786	
10	98266-0096	98266-0098	98266-0100	98266-0102	98266-0104	98266-0106	98266-0108	98266-0110	98266-0112	98266-0114	98266-0116	
11	98266-0788	98266-0790	98266-0792	98266-0794	98266-0796	98266-0798	98266-0800	98266-0802	98266-0804	98266-0806	98266-0808	
12	98266-0118	98266-0120	98266-0122	98266-0124	98266-0126	98266-0128	98266-0130	98266-0132	98266-0134	98266-0136	98266-0138	
13	98266-0810	98266-0812	98266-0814	98266-0816	98266-0818	98266-0820	98266-0822	98266-0824	98266-0826	98266-0828	98266-0830	
14	98266-0140	98266-0142	98266-0144	98266-0146	98266-0148	98266-0150	98266-0152	98266-0154	98266-0156	98266-0158	98266-0160	
15	98266-0832	98266-0834	98266-0836	98266-0838	98266-0840	98266-0842	98266-0844	98266-0846	98266-0848	98266-0850	98266-0852	
16	98266-0162	98266-0164	98266-0166	98266-0168	98266-0170	98266-0172	98266-0174	98266-0176	98266-0178	98266-0180	98266-0182	
17	98266-0854	98266-0856	98266-0858	98266-0860	98266-0862	98266-0864	98266-0866	98266-0868	98266-0870	98266-0872	98266-0874	
18	98266-0184	98266-0186	98266-0188	98266-0190	98266-0192	98266-0194	98266-0196	98266-0198	98266-0200	98266-0202	98266-0204	
19	98266-0876	98266-0878	98266-0880	98266-0882	98266-0884	98266-0886	98266-0888	98266-0890	98266-0892	98266-0894	98266-0896	
20	98266-0206	98266-0208	98266-0210	98266-0212	98266-0214	98266-0216	98266-0218	98266-0220	98266-0222	98266-0224	98266-0226	
21	98266-0898	98266-0900	98266-0902	98266-0904	98266-0906	98266-0908	98266-0910	98266-0912	98266-0914	98266-0916	98266-0918	
22	98266-0228	98266-0230	98266-0232	98266-0234	98266-0236	98266-0238	98266-0240	98266-0242	98266-0244	98266-0246	98266-0248	
23	98266-0920	98266-0922	98266-0924	98266-0926	98266-0928	98266-0930	98266-0932	98266-0934	98266-0936	98266-0938	98266-0940	
24	98266-0250	98266-0252	98266-0254	98266-0256	98266-0258	98266-0260	98266-0262	98266-0264	98266-0266	98266-0268	98266-0270	
25	98266-0942	98266-0944	98266-0946	98266-0948	98266-0950	98266-0952	98266-0954	98266-0956	98266-0958	98266-0960	98266-0962	
26	98266-0272	98266-0274	98266-0276	98266-0278	98266-0280	98266-0282	98266-0284	98266-0286	98266-0288	98266-0290	98266-0292	
27	98266-0964	98266-0966	98266-0968	98266-0970	98266-0972	98266-0974	98266-0976	98266-0978	98266-0980	98266-0982	98266-0984	
28	98266-0294	98266-0296	98266-0298	98266-0300	98266-0302	98266-0304	98266-0306	98266-0308	98266-0310	98266-0312	98266-0314	
29	98266-0986	98266-0988	98266-0990	98266-0992	98266-0994	98266-0996	98266-0998	98266-1000	98266-1002	98266-1004	98266-1006	
30	98266-0316	98266-0318	98266-0320	98266-0322	98266-0324	98266-0326	98266-0328	98266-0330	98266-0332	98266-0334	98266-0336	
31	98266-1008	98266-1010	98266-1012	98266-1014	98266-1016	98266-1018	98266-1020	98266-1022	98266-1024	98266-1026	98266-1028	
32	98266-0338	98266-0340	98266-0342	98266-0344	98266-0346	98266-0348	98266-0350	98266-0352	98266-0354	98266-0356	98266-0358	
33	98266-1030	98266-1032	98266-1034	98266-1036	98266-1038	98266-1040	98266-1042	98266-1044	98266-1046	98266-1048	98266-1050	
34	98266-0360	98266-0362	98266-0364	98266-0366	98266-0368	98266-0370	98266-0372	98266-0374	98266-0376	98266-0378	98266-0380	
35	98266-1052	98266-1054	98266-1056	98266-1058	98266-1060	98266-1062	98266-1064	98266-1066	98266-1068	98266-1070	98266-1072	
36	98266-0382	98266-0384	98266-0386	98266-0388	98266-0390	98266-0392	98266-0394	98266-0396	98266-0398	98266-0400	98266-0402	
37	98266-1074	98266-1076	98266-1078	98266-1080	98266-1082	98266-1084	98266-1086	98266-1088	98266-1090	98266-1092	98266-1094	
38	98266-0404	98266-0406	98266-0408	98266-0410	98266-0412	98266-0414	98266-0416	98266-0418	98266-0420	98266-0422	98266-0424	
39	98266-1096	98266-1098	98266-1100	98266-1102	98266-1104	98266-1106	98266-1108	98266-1110	98266-1112	98266-1114	98266-1116	
40	98266-0426	98266-0428	98266-0430	98266-0432	98266-0434	98266-0436	98266-0438	98266-0440	98266-0442	98266-0444	98266-0446	
41	98266-1118	98266-1120	98266-1122	98266-1124	98266-1126	98266-1128	98266-1130	98266-1132	98266-1134	98266-1136	98266-1138	
42	98266-0448	98266-0450	98266-0452	98266-0454	98266-0456	98266-0458	98266-0460	98266-0462	98266-0464	98266-0466	98266-0468	
43	98266-1140	98266-1142	98266-1144	98266-1146	98266-1148	98266-1150	98266-1152	98266-1154	98266-1156	98266-1158	98266-1160	
44	98266-0470	98266-0472	98266-0474	98266-0476	98266-0478	98266-0480	98266-0482	98266-0484	98266-0486	98266-0488	98266-0490	
45	98266-1162	98266-1164	98266-1166	98266-1168	98266-1170	98266-1172	98266-1174	98266-1176	98266-1178	98266-1180	98266-1182	
46	98266-0492	98266-0494	98266-0496	98266-0498	98266-0500	98266-0502	98266-0504	98266-0506	98266-0508	98266-0510	98266-0512	
47	98266-1184	98266-1186	98266-1188	98266-1190	98266-1192	98266-1194	98266-1196	98266-1198	98266-1200	98266-1202	98266-1204	
48	98266-0514	98266-0516	98266-0518	98266-0520	98266-0522	98266-0524	98266-0526	98266-0528	98266-0530	98266-0532	98266-0534	
49	98266-1206	98266-1208	98266-1210	98266-1212	98266-1214	98266-1216	98266-1218	98266-1220	98266-1222	98266-1224	98266-1226	
50	98266-0536	98266-0538	98266-0540	98266-0542	98266-0544	98266-0546	98266-0548	98266-0550	98266-0552	98266-0554	98266-0556	

1.00mm (.039") Pitch Premo-Flex™ Flat Flex Cable Jumpers

21039
Standard

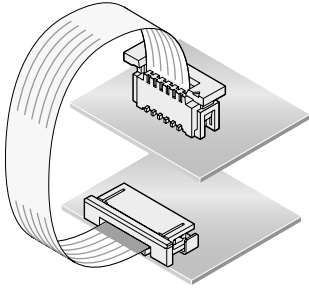

Molex introduces a complete line of 1.00mm (.039") pitch Flat Flex Cable jumpers. These jumpers are used to connect 2 PC boards and terminate to either ZIF or Non-ZIF FFC Connectors.

Molex 1.00mm (.039") Flat Flex Cable jumpers are available in a wide variety of lengths and circuit sizes. These standard lengths are easy to order and feature shorter lead times.

Reference Information

UL Style No.: 2896
Mates With: Any 1.00mm (.039") pitch Molex FFC/FPC connector
Designed In: Millimeters

Electrical
Voltage: 30V
Current: 1.2A

Physical
Strip Length: 4.0mm (.157")
Reinforcement Length: 8.00mm (.315")
Width: (N + 1) 1.00mm
Span: (N - 1) 1.00mm
Margin: 0.65mm (.026")
Conductor Width: 0.70mm (.028")
Conductor Thickness: 0.10mm (.004")
End Thickness: 0.30 ± 0.05mm (.012 ± .002")

Type A FFC Jumpers—Contacts on same side (Preferred version in North America)

Circuits	Order No.											Lead-free
	Overall Length											
	30.00mm (1.181")	51.00mm (2.00")	76.00mm (3.00")	102.00mm (4.00")	127.00mm (5.00")	152.00mm (6.00")	178.00mm (7.00")	203.00mm (8.00")	229.00mm (9.00")	254.00mm (10.00")	305.00mm (12.00")	
4	21039-0701	21039-0703	21039-0705	21039-0707	21039-0709	21039-0711	21039-0713	21039-0715	21039-0717	21039-0719	21039-0721	
5	21039-0723	21039-0725	21039-0727	21039-0729	21039-0731	21039-0733	21039-0735	21039-0737	21039-0739	21039-0741	21039-0743	
6	21039-0201	21039-0203	21039-0205	21039-0207	21039-0209	21039-0211	21039-0213	21039-0215	21039-0217	21039-0219	21039-0221	
7	21039-0745	21039-0747	21039-0749	21039-0751	21039-0753	21039-0755	21039-0757	21039-0759	21039-0761	21039-0763	21039-0765	
8	21039-0223	21039-0225	21039-0227	21039-0229	21039-0231	21039-0233	21039-0235	21039-0237	21039-0239	21039-0241	21039-0243	
9	21039-0767	21039-0769	21039-0771	21039-0773	21039-0775	21039-0777	21039-0779	21039-0781	21039-0783	21039-0785	21039-0787	
10	21039-0245	21039-0247	21039-0249	21039-0251	21039-0253	21039-0255	21039-0257	21039-0259	21039-0261	21039-0263	21039-0265	
11	21039-0789	21039-0791	21039-0793	21039-0795	21039-0797	21039-0799	21039-0801	21039-0803	21039-0805	21039-0807	21039-0809	
12	21039-0267	21039-0269	21039-0271	21039-0273	21039-0275	21039-0277	21039-0279	21039-0281	21039-0283	21039-0285	21039-0287	
13	21039-0811	21039-0813	21039-0815	21039-0817	21039-0819	21039-0821	21039-0823	21039-0825	21039-0827	21039-0829	21039-0831	
14	21039-0289	21039-0291	21039-0293	21039-0295	21039-0297	21039-0299	21039-0301	21039-0303	21039-0305	21039-0307	21039-0309	
15	21039-0833	21039-0835	21039-0837	21039-0839	21039-0841	21039-0843	21039-0845	21039-0847	21039-0849	21039-0851	21039-0853	
16	21039-0311	21039-0313	21039-0315	21039-0317	21039-0319	21039-0321	21039-0323	21039-0325	21039-0327	21039-0329	21039-0331	
17	21039-0855	21039-0857	21039-0859	21039-0861	21039-0863	21039-0865	21039-0867	21039-0869	21039-0871	21039-0873	21039-0875	
18	21039-0333	21039-0335	21039-0337	21039-0339	21039-0341	21039-0343	21039-0345	21039-0347	21039-0349	21039-0351	21039-0353	
19	21039-0877	21039-0879	21039-0881	21039-0883	21039-0885	21039-0887	21039-0889	21039-0891	21039-0893	21039-0895	21039-0897	
20	21039-0355	21039-0357	21039-0359	21039-0361	21039-0363	21039-0365	21039-0367	21039-0369	21039-0371	21039-0373	21039-0375	
21	21039-0899	21039-0901	21039-0903	21039-0905	21039-0907	21039-0909	21039-0911	21039-0913	21039-0915	21039-0917	21039-0919	
22	21039-0377	21039-0379	21039-0381	21039-0383	21039-0385	21039-0387	21039-0389	21039-0391	21039-0393	21039-0395	21039-0397	Yes
23	21039-0921	21039-0923	21039-0925	21039-0927	21039-0929	21039-0931	21039-0933	21039-0935	21039-0937	21039-0939	21039-0941	
24	21039-0399	21039-0401	21039-0403	21039-0405	21039-0407	21039-0409	21039-0411	21039-0413	21039-0415	21039-0417	21039-0419	
25	21039-0943	21039-0945	21039-0947	21039-0949	21039-0951	21039-0953	21039-0955	21039-0957	21039-0959	21039-0961	21039-0963	
26	21039-0421	21039-0423	21039-0425	21039-0427	21039-0429	21039-0431	21039-0433	21039-0435	21039-0437	21039-0439	21039-0441	
27	21039-0965	21039-0967	21039-0969	21039-0971	21039-0973	21039-0975	21039-0977	21039-0979	21039-0981	21039-0983	21039-0985	
28	21039-0443	21039-0445	21039-0447	21039-0449	21039-0451	21039-0453	21039-0455	21039-0457	21039-0459	21039-0461	21039-0463	
29	21039-0987	21039-0989	21039-0991	21039-0993	21039-0995	21039-0997	21039-0999	21039-1001	21039-1003	21039-1005	21039-1007	
30	21039-0465	21039-0467	21039-0469	21039-0471	21039-0473	21039-0475	21039-0477	21039-0479	21039-0481	21039-0483	21039-0485	
31	21039-1009	21039-1011	21039-1013	21039-1015	21039-1017	21039-1019	21039-1021	21039-1023	21039-1025	21039-1027	21039-1029	
32	21039-0487	21039-0489	21039-0491	21039-0493	21039-0495	21039-0497	21039-0499	21039-0501	21039-0503	21039-0505	21039-0507	
33	21039-1031	21039-1033	21039-1035	21039-1037	21039-1039	21039-1041	21039-1043	21039-1045	21039-1047	21039-1049	21039-1051	
34	21039-0509	21039-0511	21039-0513	21039-0515	21039-0517	21039-0519	21039-0521	21039-0523	21039-0525	21039-0527	21039-0529	
35	21039-1053	21039-1055	21039-1057	21039-1059	21039-1061	21039-1063	21039-1065	21039-1067	21039-1069	21039-1071	21039-1073	
36	21039-0531	21039-0533	21039-0535	21039-0537	21039-0539	21039-0541	21039-0543	21039-0545	21039-0547	21039-0549	21039-0551	
37	21039-1075	21039-1077	21039-1079	21039-1081	21039-1083	21039-1085	21039-1087	21039-1089	21039-1091	21039-1093	21039-1095	
38	21039-0553	21039-0555	21039-0557	21039-0559	21039-0561	21039-0563	21039-0565	21039-0567	21039-0569	21039-0571	21039-0573	
39	21039-1097	21039-1099	21039-1101	21039-1103	21039-1105	21039-1107	21039-1109	21039-1111	21039-1113	21039-1115	21039-1117	
40	21039-0575	21039-0577	21039-0579	21039-0581	21039-0583	21039-0585	21039-0587	21039-0589	21039-0591	21039-0593	21039-0595	

Custom jumpers available

1.00mm (.039") Pitch Premo-Flex™ Flat Flex Cable Jumpers

21039 Standard

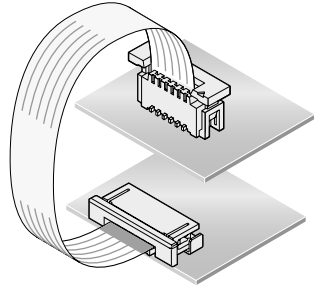

Molex introduces a complete line of 1.00mm (.039") pitch Flat Flex Cable jumpers. These jumpers are used to connect 2 PC boards and terminate to either ZIF or Non-ZIF FFC Connectors.

Molex 1.00mm (.039") Flat Flex Cable jumpers are available in a wide variety of lengths and circuit sizes. These standard lengths are easy to order and feature shorter lead times.

Reference Information

UL Style No.: 2896

Mates With: Any 1.00mm (.039") pitch Molex FFC/FPC connector

Designed In: Millimeters

Electrical
Voltage: 30V
Current: 1.2A

Physical
Strip Length: 4.0mm (.157")
Reinforcement Length: 8.00mm (.315")
Width: (N + 1) 1.00mm
Span: (N - 1) 1.00mm
Margin: 0.65mm (.026")
Conductor Width: 0.70mm (.028")
Conductor Thickness: 0.10mm (.004")
End Thickness: 0.30 ± 0.05mm (.012 ± .002")

Type D FFC Jumpers—Contacts on opposite sides (Preferred version in North America)

Circuits	Order No.											Lead-free
	Overall Length											
	30.00mm (1.181")	51.00mm (2.00")	76.00mm (3.00")	102.00mm (4.00")	127.00mm (5.00")	152.00mm (6.00")	178.00mm (7.00")	203.00mm (8.00")	229.00mm (9.00")	254.00mm (10.00")	305.00mm (12.00")	
4	21039-0700	21039-0702	21039-0704	21039-0706	21039-0708	21039-0710	21039-0712	21039-0714	21039-0716	21039-0718	21039-0720	
5	21039-0722	21039-0724	21039-0726	21039-0728	21039-0730	21039-0732	21039-0734	21039-0736	21039-0738	21039-0740	21039-0742	
6	21039-0202	21039-0204	21039-0206	21039-0208	21039-0210	21039-0212	21039-0214	21039-0216	21039-0218	21039-0220	21039-0222	
7	21039-0744	21039-0746	21039-0748	21039-0750	21039-0752	21039-0754	21039-0756	21039-0758	21039-0760	21039-0762	21039-0764	
8	21039-0224	21039-0226	21039-0228	21039-0230	21039-0232	21039-0234	21039-0236	21039-0238	21039-0240	21039-0242	21039-0244	
9	21039-0766	21039-0768	21039-0770	21039-0772	21039-0774	21039-0776	21039-0778	21039-0780	21039-0782	21039-0784	21039-0786	
10	21039-0246	21039-0248	21039-0250	21039-0252	21039-0254	21039-0256	21039-0258	21039-0260	21039-0262	21039-0264	21039-0266	
11	21039-0788	21039-0790	21039-0792	21039-0794	21039-0796	21039-0798	21039-0800	21039-0802	21039-0804	21039-0806	21039-0808	
12	21039-0268	21039-0270	21039-0272	21039-0274	21039-0276	21039-0278	21039-0280	21039-0282	21039-0284	21039-0286	21039-0288	
13	21039-0810	21039-0812	21039-0814	21039-0816	21039-0818	21039-0820	21039-0822	21039-0824	21039-0826	21039-0828	21039-0830	
14	21039-0290	21039-0292	21039-0294	21039-0296	21039-0298	21039-0300	21039-0302	21039-0304	21039-0306	21039-0308	21039-0310	
15	21039-0832	21039-0834	21039-0836	21039-0838	21039-0840	21039-0842	21039-0844	21039-0846	21039-0848	21039-0850	21039-0852	
16	21039-0312	21039-0314	21039-0316	21039-0318	21039-0320	21039-0322	21039-0324	21039-0326	21039-0328	21039-0330	21039-0332	
17	21039-0854	21039-0856	21039-0858	21039-0860	21039-0862	21039-0864	21039-0866	21039-0868	21039-0870	21039-0872	21039-0874	
18	21039-0334	21039-0336	21039-0338	21039-0340	21039-0342	21039-0344	21039-0346	21039-0348	21039-0350	21039-0352	21039-0354	
19	21039-0876	21039-0878	21039-0880	21039-0882	21039-0884	21039-0886	21039-0888	21039-0890	21039-0892	21039-0894	21039-0896	
20	21039-0356	21039-0358	21039-0360	21039-0362	21039-0364	21039-0366	21039-0368	21039-0370	21039-0372	21039-0374	21039-0376	
21	21039-0898	21039-0900	21039-0902	21039-0904	21039-0906	21039-0908	21039-0910	21039-0912	21039-0914	21039-0916	21039-0918	
22	21039-0378	21039-0380	21039-0382	21039-0384	21039-0386	21039-0388	21039-0390	21039-0392	21039-0394	21039-0396	21039-0398	Yes
23	21039-0920	21039-0922	21039-0924	21039-0926	21039-0928	21039-0930	21039-0932	21039-0934	21039-0936	21039-0938	21039-0940	
24	21039-0400	21039-0402	21039-0404	21039-0406	21039-0408	21039-0410	21039-0412	21039-0414	21039-0416	21039-0418	21039-0420	
25	21039-0942	21039-0944	21039-0946	21039-0948	21039-0950	21039-0952	21039-0954	21039-0956	21039-0958	21039-0960	21039-0962	
26	21039-0422	21039-0424	21039-0426	21039-0428	21039-0430	21039-0432	21039-0434	21039-0436	21039-0438	21039-0440	21039-0442	
27	21039-0964	21039-0966	21039-0968	21039-0970	21039-0972	21039-0974	21039-0976	21039-0978	21039-0980	21039-0982	21039-0984	
28	21039-0444	21039-0446	21039-0448	21039-0450	21039-0452	21039-0454	21039-0456	21039-0458	21039-0460	21039-0462	21039-0464	
29	21039-0986	21039-0988	21039-0990	21039-0992	21039-0994	21039-0996	21039-0998	21039-1000	21039-1002	21039-1004	21039-1006	
30	21039-0466	21039-0468	21039-0470	21039-0472	21039-0474	21039-0476	21039-0478	21039-0480	21039-0482	21039-0484	21039-0486	
31	21039-1008	21039-1010	21039-1012	21039-1014	21039-1016	21039-1018	21039-1020	21039-1022	21039-1024	21039-1026	21039-1028	
32	21039-0488	21039-0490	21039-0492	21039-0494	21039-0496	21039-0498	21039-0500	21039-0502	21039-0504	21039-0506	21039-0508	
33	21039-1030	21039-1032	21039-1034	21039-1036	21039-1038	21039-1040	21039-1042	21039-1044	21039-1046	21039-1048	21039-1050	
34	21039-0510	21039-0512	21039-0514	21039-0516	21039-0518	21039-0520	21039-0522	21039-0524	21039-0526	21039-0528	21039-0530	
35	21039-1052	21039-1054	21039-1056	21039-1058	21039-1060	21039-1062	21039-1064	21039-1066	21039-1068	21039-1070	21039-1072	
36	21039-0532	21039-0534	21039-0536	21039-0538	21039-0540	21039-0542	21039-0544	21039-0546	21039-0548	21039-0550	21039-0552	
37	21039-1074	21039-1076	21039-1078	21039-1080	21039-1082	21039-1084	21039-1086	21039-1088	21039-1090	21039-1092	21039-1094	
38	21039-0554	21039-0556	21039-0558	21039-0560	21039-0562	21039-0564	21039-0566	21039-0568	21039-0570	21039-0572	21039-0574	
39	21039-1096	21039-1098	21039-1100	21039-1102	21039-1104	21039-1106	21039-1108	21039-1110	21039-1112	21039-1114	21039-1116	
40	21039-0576	21039-0578	21039-0580	21039-0582	21039-0584	21039-0586	21039-0588	21039-0590	21039-0592	21039-0594	21039-0596	

Custom jumpers available

1.00mm (.039") Pitch Premo-Flex™ Flat Flex Cable Jumpers

98267
Standard

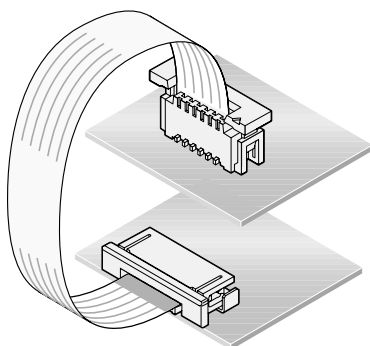

Molex introduces a complete line of 1.00mm (.039") pitch Flat Flex Cable jumpers. These jumpers are used to connect 2 PC boards and terminate to either ZIF or Non-ZIF FFC connectors.

Molex 1.00mm (.020") Flat Flex Cable jumpers are available in a wide variety of lengths and circuit sizes. These standard lengths are easy to order and feature shorter lead times.

We are also able to offer customized lengths and circuit sizes.

Reference Information

Product Specification: PS-98267-001

Packaging: Box

UL Style No.: 20706

Mates With: Any 1.00mm (.039") Pitch Molex FFC/FPC connector

Designed In: Millimeters

Electrical
Voltage: 60V
Current: 1.2A

Physical
Strip Length: 4.0mm (.157")
Reinforcement Length: 8.0mm (.315")
Width: (N + 1) 1.00mm
Span: (N - 1) 1.00mm
Margin: 0.65mm (.014")
Conductor Width: 0.70mm (.012")
Conductor Thickness: 0.10mm (.004")
End Thickness: 0.30 ± 0.05mm (.012 ± .002")

Type A Jumpers—Contacts on same side (Preferred version in Europe)

Circuits	Order No.											Lead-free
	Overall Length											
	30mm (1.181")	51mm (2.00")	76mm (3.00")	102mm (4.00")	127mm (5.00")	152mm (6.00")	178mm (7.00")	203mm (8.00")	229mm (9.00")	254mm (10.00")	305mm (12.00")	
4	98267-0701	98267-0703	98267-0705	98267-0707	98267-0709	98267-0711	98267-0713	98267-0715	98267-0717	98267-0719	98267-0721	
5	98267-0723	98267-0725	98267-0727	98267-0729	98267-0731	98267-0733	98267-0735	98267-0737	98267-0739	98267-0741	98267-0743	
6	98267-0201	98267-0203	98267-0205	98267-0207	98267-0209	98267-0211	98267-0213	98267-0215	98267-0217	98267-0219	98267-0221	
7	98267-0745	98267-0747	98267-0749	98267-0751	98267-0753	98267-0755	98267-0757	98267-0759	98267-0761	98267-0763	98267-0765	
8	98267-0223	98267-0225	98267-0227	98267-0229	98267-0231	98267-0233	98267-0235	98267-0237	98267-0239	98267-0241	98267-0243	
9	98267-0767	98267-0769	98267-0771	98267-0773	98267-0775	98267-0777	98267-0779	98267-0781	98267-0783	98267-0785	98267-0787	
10	98267-0245	98267-0247	98267-0249	98267-0251	98267-0253	98267-0255	98267-0257	98267-0259	98267-0261	98267-0263	98267-0265	
11	98267-0789	98267-0791	98267-0793	98267-0795	98267-0797	98267-0799	98267-0801	98267-0803	98267-0805	98267-0807	98267-0809	
12	98267-0267	98267-0269	98267-0271	98267-0273	98267-0275	98267-0277	98267-0279	98267-0281	98267-0283	98267-0285	98267-0287	
13	98267-0811	98267-0813	98267-0815	98267-0817	98267-0819	98267-0821	98267-0823	98267-0825	98267-0827	98267-0829	98267-0831	
14	98267-0289	98267-0291	98267-0293	98267-0295	98267-0297	98267-0299	98267-0301	98267-0303	98267-0305	98267-0307	98267-0309	
15	98267-0833	98267-0835	98267-0837	98267-0839	98267-0841	98267-0843	98267-0845	98267-0847	98267-0849	98267-0851	98267-0853	
16	98267-0311	98267-0313	98267-0315	98267-0317	98267-0319	98267-0321	98267-0323	98267-0325	98267-0327	98267-0329	98267-0331	
17	98267-0855	98267-0857	98267-0859	98267-0861	98267-0863	98267-0865	98267-0867	98267-0869	98267-0871	98267-0873	98267-0875	
18	98267-0333	98267-0335	98267-0337	98267-0339	98267-0341	98267-0343	98267-0345	98267-0347	98267-0349	98267-0351	98267-0353	
19	98267-0877	98267-0879	98267-0881	98267-0883	98267-0885	98267-0887	98267-0889	98267-0891	98267-0893	98267-0895	98267-0897	
20	98267-0355	98267-0357	98267-0359	98267-0361	98267-0363	98267-0365	98267-0367	98267-0369	98267-0371	98267-0373	98267-0375	
21	98267-0899	98267-0901	98267-0903	98267-0905	98267-0907	98267-0909	98267-0911	98267-0913	98267-0915	98267-0917	98267-0919	
22	98267-0377	98267-0379	98267-0381	98267-0383	98267-0385	98267-0387	98267-0389	98267-0391	98267-0393	98267-0395	98267-0397	Yes
23	98267-0921	98267-0923	98267-0925	98267-0927	98267-0929	98267-0931	98267-0933	98267-0935	98267-0937	98267-0939	98267-0941	
24	98267-0399	98267-0401	98267-0403	98267-0405	98267-0407	98267-0409	98267-0411	98267-0413	98267-0415	98267-0417	98267-0419	
25	98267-0943	98267-0945	98267-0947	98267-0949	98267-0951	98267-0953	98267-0955	98267-0957	98267-0959	98267-0961	98267-0963	
26	98267-0421	98267-0423	98267-0425	98267-0427	98267-0429	98267-0431	98267-0433	98267-0435	98267-0437	98267-0439	98267-0441	
27	98267-0965	98267-0967	98267-0969	98267-0971	98267-0973	98267-0975	98267-0977	98267-0979	98267-0981	98267-0983	98267-0985	
28	98267-0443	98267-0445	98267-0447	98267-0449	98267-0451	98267-0453	98267-0455	98267-0457	98267-0459	98267-0461	98267-0463	
29	98267-0987	98267-0989	98267-0991	98267-0993	98267-0995	98267-0997	98267-0999	98267-1001	98267-1003	98267-1005	98267-1007	
30	98267-0465	98267-0467	98267-0469	98267-0471	98267-0473	98267-0475	98267-0477	98267-0479	98267-0481	98267-0483	98267-0485	
31	98267-1009	98267-1011	98267-1013	98267-1015	98267-1017	98267-1019	98267-1021	98267-1023	98267-1025	98267-1027	98267-1029	
32	98267-0487	98267-0489	98267-0491	98267-0493	98267-0495	98267-0497	98267-0499	98267-0501	98267-0503	98267-0505	98267-0507	
33	98267-1031	98267-1033	98267-1035	98267-1037	98267-1039	98267-1041	98267-1043	98267-1045	98267-1047	98267-1049	98267-1051	
34	98267-0509	98267-0511	98267-0513	98267-0515	98267-0517	98267-0519	98267-0521	98267-0523	98267-0525	98267-0527	98267-0529	
35	98267-1053	98267-1055	98267-1057	98267-1059	98267-1061	98267-1063	98267-1065	98267-1067	98267-1069	98267-1071	98267-1073	
36	98267-0531	98267-0533	98267-0535	98267-0537	98267-0539	98267-0541	98267-0543	98267-0545	98267-0547	98267-0549	98267-0551	
37	98267-1075	98267-1077	98267-1079	98267-1081	98267-1083	98267-1085	98267-1087	98267-1089	98267-1091	98267-1093	98267-1095	
38	98267-0553	98267-0555	98267-0557	98267-0559	98267-0561	98267-0563	98267-0565	98267-0567	98267-0569	98267-0571	98267-0573	
39	98267-1097	98267-1099	98267-1101	98267-1103	98267-1105	98267-1107	98267-1109	98267-1111	98267-1113	98267-1115	98267-1117	
40	98267-0575	98267-0577	98267-0579	98267-0581	98267-0583	98267-0585	98267-0587	98267-0589	98267-0591	98267-0593	98267-0595	

1.00mm (.039") Pitch Premo-Flex™ Flat Flex Cable Jumpers

**98267
Standard**

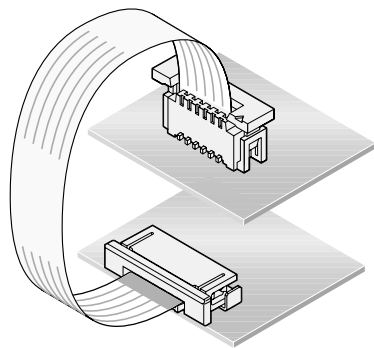

Molex introduces a complete line of 1.00mm (.039") pitch Flat Flex Cable jumpers. These jumpers are used to connect 2 PC boards and terminate to either ZIF or Non-ZIF FFC connectors.

Molex 1.00mm (.020") Flat Flex Cable jumpers are available in a wide variety of lengths and circuit sizes. These standard lengths are easy to order and feature shorter lead times.

We are also able to offer customized lengths and circuit sizes.

Reference Information

Product Specification: PS-98267-001
Packaging: Box
UL Style No.: 20706
Mates With: Any 1.00mm (.039") Pitch Molex FFC/FPC connector
Designed In: Millimeters

Electrical
Voltage: 60V
Current: 1.2A

Physical
Strip Length: 4.0mm (.157")
Reinforcement Length: 8.0mm (.315")
Width: (N + 1) 1.00mm
Span: (N - 1) 1.00mm
Margin: 0.65mm (.014")
Conductor Width: 0.70mm (.012")
Conductor Thickness: 0.10mm (.004")
End Thickness: 0.30 ± 0.05mm (.012 ± .002")

Type D Jumpers—Contacts on opposite side (Preferred version in Europe)

Circuits	Order No.											Lead-free
	Overall Length											
	30mm (1.181")	51mm (2.00")	76mm (3.00")	102mm (4.00")	127mm (5.00")	152mm (6.00")	178mm (7.00")	203mm (8.00")	229mm (9.00")	254mm (10.00")	305mm (12.00")	
4	98267-0700	98267-0702	98267-0704	98267-0706	98267-0708	98267-0710	98267-0712	98267-0714	98267-0716	98267-0718	98267-0720	
5	98267-0722	98267-0724	98267-0726	98267-0728	98267-0730	98267-0732	98267-0734	98267-0736	98267-0738	98267-0740	98267-0742	
6	98267-0202	98267-0204	98267-0206	98267-0208	98267-0210	98267-0212	98267-0214	98267-0216	98267-0218	98267-0220	98267-0222	
7	98267-0744	98267-0746	98267-0748	98267-0750	98267-0752	98267-0754	98267-0756	98267-0758	98267-0760	98267-0762	98267-0764	
8	98267-0224	98267-0226	98267-0228	98267-0230	98267-0232	98267-0234	98267-0236	98267-0238	98267-0240	98267-0242	98267-0244	
9	98267-0766	98267-0768	98267-0770	98267-0772	98267-0774	98267-0776	98267-0778	98267-0780	98267-0782	98267-0784	98267-0786	
10	98267-0246	98267-0248	98267-0250	98267-0252	98267-0254	98267-0256	98267-0258	98267-0260	98267-0262	98267-0264	98267-0266	
11	98267-0788	98267-0790	98267-0792	98267-0794	98267-0796	98267-0798	98267-0800	98267-0802	98267-0804	98267-0806	98267-0808	
12	98267-0268	98267-0270	98267-0272	98267-0274	98267-0276	98267-0278	98267-0280	98267-0282	98267-0284	98267-0286	98267-0288	
13	98267-0810	98267-0812	98267-0814	98267-0816	98267-0818	98267-0820	98267-0822	98267-0824	98267-0826	98267-0828	98267-0830	
14	98267-0290	98267-0292	98267-0294	98267-0296	98267-0298	98267-0300	98267-0302	98267-0304	98267-0306	98267-0308	98267-0310	
15	98267-0832	98267-0834	98267-0836	98267-0838	98267-0840	98267-0842	98267-0844	98267-0846	98267-0848	98267-0850	98267-0852	
16	98267-0312	98267-0314	98267-0315	98267-0318	98267-0320	98267-0322	98267-0324	98267-0326	98267-0328	98267-0330	98267-0332	
17	98267-0854	98267-0856	98267-0858	98267-0860	98267-0862	98267-0864	98267-0866	98267-0868	98267-0870	98267-0872	98267-0874	
18	98267-0334	98267-0336	98267-0338	98267-0340	98267-0342	98267-0344	98267-0346	98267-0348	98267-0350	98267-0352	98267-0354	
19	98267-0876	98267-0878	98267-0880	98267-0882	98267-0884	98267-0886	98267-0888	98267-0890	98267-0892	98267-0894	98267-0896	
20	98267-0356	98267-0358	98267-0360	98267-0362	98267-0364	98267-0366	98267-0368	98267-0370	98267-0372	98267-0374	98267-0376	
21	98267-0898	98267-0900	98267-0902	98267-0904	98267-0906	98267-0908	98267-0910	98267-0912	98267-0914	98267-0916	98267-0918	
22	98267-0378	98267-0380	98267-0382	98267-0384	98267-0386	98267-0388	98267-0390	98267-0392	98267-0394	98267-0396	98267-0398	Yes
23	98267-0920	98267-0922	98267-0924	98267-0926	98267-0928	98267-0930	98267-0932	98267-0934	98267-0936	98267-0938	98267-0940	
24	98267-0400	98267-0402	98267-0404	98267-0406	98267-0408	98267-0410	98267-0412	98267-0414	98267-0416	98267-0418	98267-0420	
25	98267-0942	98267-0944	98267-0946	98267-0948	98267-0950	98267-0952	98267-0954	98267-0956	98267-0958	98267-0960	98267-0962	
26	98267-0422	98267-0424	98267-0426	98267-0428	98267-0430	98267-0432	98267-0434	98267-0436	98267-0438	98267-0440	98267-0442	
27	98267-0964	98267-0966	98267-0968	98267-0970	98267-0972	98267-0974	98267-0976	98267-0978	98267-0980	98267-0982	98267-0984	
28	98267-0444	98267-0446	98267-0448	98267-0450	98267-0452	98267-0454	98267-0456	98267-0458	98267-0460	98267-0462	98267-0464	
29	98267-0986	98267-0988	98267-0990	98267-0992	98267-0994	98267-0996	98267-0998	98267-1000	98267-1002	98267-1004	98267-1006	
30	98267-0466	98267-0468	98267-0470	98267-0472	98267-0474	98267-0476	98267-0478	98267-0480	98267-0482	98267-0484	98267-0486	
31	98267-1008	98267-1010	98267-1012	98267-1014	98267-1016	98267-1018	98267-1020	98267-1022	98267-1024	98267-1026	98267-1028	
32	21039-0488	98267-0490	98267-0492	98267-0494	98267-0496	98267-0498	98267-0500	98267-0502	98267-0504	98267-0506	98267-0508	
33	98267-1030	98267-1032	98267-1034	98267-1036	98267-1038	98267-1040	98267-1042	98267-1044	98267-1046	98267-1048	98267-1050	
34	98267-0510	98267-0512	98267-0514	98267-0516	98267-0518	98267-0520	98267-0522	98267-0524	98267-0526	98267-0528	98267-0530	
35	98267-1052	98267-1054	98267-1056	98267-1058	98267-1060	98267-1062	98267-1064	98267-1066	98267-1068	98267-1070	98267-1072	
36	98267-0532	98267-0534	98267-0536	98267-0538	98267-0540	98267-0542	98267-0544	98267-0546	98267-0548	98267-0550	98267-0552	
37	98267-1074	98267-1076	98267-1078	98267-1080	98267-1082	98267-1084	98267-1086	98267-1088	98267-1090	98267-1092	98267-1094	
38	98267-0554	98267-0556	98267-0558	98267-0560	98267-0562	98267-0564	98267-0566	98267-0568	98267-0570	98267-0572	98267-0574	
39	98267-1096	98267-1098	98267-1100	98267-1102	98267-1104	98267-1106	98267-1108	98267-1110	98267-1112	98267-1114	98267-1116	
40	98267-0576	98267-0578	98267-0580	98267-0582	98267-0584	98267-0586	98267-0588	98267-0590	98267-0592	98267-0594	98267-0596	

1.25mm (.049") Pitch Premo-Flex™ Flat Flex Cable Jumpers

**21049
Standard**

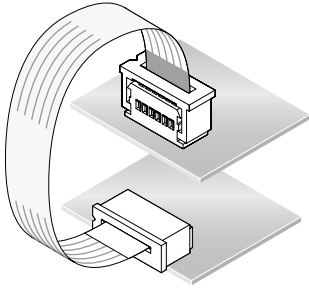

Molex introduces a complete line of 1.25mm (.049") pitch Flat Flex Cable jumpers. These jumpers are used to connect 2 PC boards and terminate to either ZIF or Non-ZIF FFC Connectors.

Molex 1.25mm (.049") Flat Flex Cable jumpers are available in a wide variety of lengths and circuit sizes. These standard lengths are easy to order and feature shorter lead times.

Reference Information

UL Style No.: 2896
Mates With: Any 1.25mm (.049") pitch Molex FFC/FPC connector
Designed In: Millimeters

Electrical
Voltage: 30V
Current: 1.2A

Physical
Strip Length: 5.0mm (.197")
Reinforcement Length: 10.00mm (.394")
Width: (N + 1) 1.25mm
Span: (N - 1) 1.25mm
Margin: 0.85mm (.033")
Conductor Width: 0.80mm (.031")
Conductor Thickness: 0.10mm (.004")
End Thickness: 0.30 ± 0.05mm (.012 ± .002")

Type A FFC Jumpers—Contacts on same side (Preferred version in North America)

Circuits	Order No.											Lead-free
	Overall Length											
	30.00mm (1.181")	51.00mm (2.00")	76.00mm (3.00")	102.00mm (4.00")	127.00mm (5.00")	152.00mm (6.00")	178.00mm (7.00")	203.00mm (8.00")	229.00mm (9.00")	254.00mm (10.00")	305.00mm (12.00")	
4	21049-0701	21049-0703	21049-0705	21049-0707	21049-0709	21049-0711	21049-0713	21049-0715	21049-0717	21049-0719	21049-0721	Yes
5	21049-0723	21049-0725	21049-0727	21049-0729	21049-0731	21049-0733	21049-0735	21049-0737	21049-0739	21049-0741	21049-0743	
6	21049-0101	21049-0103	21049-0105	21049-0107	21049-0109	21049-0111	21049-0113	21049-0115	21049-0117	21049-0119	21049-0121	
7	21049-0745	21049-0747	21049-0749	21049-0751	21049-0753	21049-0755	21049-0757	21049-0759	21049-0761	21049-0763	21049-0765	
8	21049-0123	21049-0125	21049-0127	21049-0129	21049-0131	21049-0133	21049-0135	21049-0137	21049-0139	21049-0141	21049-0143	
9	21049-0767	21049-0769	21049-0771	21049-0773	21049-0775	21049-0777	21049-0779	21049-0781	21049-0783	21049-0785	21049-0787	
10	21049-0145	21049-0147	21049-0149	21049-0151	21049-0153	21049-0155	21049-0157	21049-0159	21049-0161	21049-0163	21049-0165	
11	21049-0789	21049-0791	21049-0793	21049-0795	21049-0797	21049-0799	21049-0801	21049-0803	21049-0805	21049-0807	21049-0809	
12	21049-0167	21049-0169	21049-0171	21049-0173	21049-0175	21049-0177	21049-0179	21049-0181	21049-0183	21049-0185	21049-0187	
13	21049-0811	21049-0813	21049-0815	21049-0817	21049-0819	21049-0821	21049-0823	21049-0825	21049-0827	21049-0829	21049-0831	
14	21049-0189	21049-0191	21049-0193	21049-0195	21049-0197	21049-0199	21049-0201	21049-0203	21049-0205	21049-0207	21049-0209	
15	21049-0833	21049-0835	21049-0837	21049-0839	21049-0841	21049-0843	21049-0845	21049-0847	21049-0849	21049-0851	21049-0853	
16	21049-0211	21049-0213	21049-0215	21049-0217	21049-0219	21049-0221	21049-0223	21049-0225	21049-0227	21049-0229	21049-0231	
17	21049-0855	21049-0857	21049-0859	21049-0861	21049-0863	21049-0865	21049-0867	21049-0869	21049-0871	21049-0873	21049-0875	
18	21049-0233	21049-0235	21049-0237	21049-0239	21049-0241	21049-0243	21049-0245	21049-0247	21049-0249	21049-0251	21049-0253	
19	21049-0877	21049-0879	21049-0881	21049-0883	21049-0885	21049-0887	21049-0889	21049-0891	21049-0893	21049-0895	21049-0897	
20	21049-0255	21049-0257	21049-0259	21049-0261	21049-0263	21049-0265	21049-0267	21049-0269	21049-0271	21049-0273	21049-0275	
21	21049-0899	21049-0901	21049-0903	21049-0905	21049-0907	21049-0909	21049-0911	21049-0913	21049-0915	21049-0917	21049-0919	
22	21049-0277	21049-0279	21049-0281	21049-0283	21049-0285	21049-0287	21049-0289	21049-0291	21049-0293	21049-0295	21049-0297	
23	21049-0921	21049-0923	21049-0925	21049-0927	21049-0929	21049-0931	21049-0933	21049-0935	21049-0937	21049-0939	21049-0941	
24	21049-0299	21049-0301	21049-0303	21049-0305	21049-0307	21049-0309	21049-0311	21049-0313	21049-0315	21049-0317	21049-0319	
25	21049-0943	21049-0945	21049-0947	21049-0949	21049-0951	21049-0953	21049-0955	21049-0957	21049-0959	21049-0961	21049-0963	
26	21049-0321	21049-0323	21049-0325	21049-0327	21049-0329	21049-0331	21049-0333	21049-0335	21049-0337	21049-0339	21049-0341	
27	21049-0965	21049-0967	21049-0969	21049-0971	21049-0973	21049-0975	21049-0977	21049-0979	21049-0981	21049-0983	21049-0985	
28	21049-0343	21049-0345	21049-0347	21049-0349	21049-0351	21049-0353	21049-0355	21049-0357	21049-0359	21049-0361	21049-0363	
29	21049-0987	21049-0989	21049-0991	21049-0993	21049-0995	21049-0997	21049-0999	21049-1001	21049-1003	21049-1005	21049-1007	
30	21049-0365	21049-0367	21049-0369	21049-0371	21049-0373	21049-0375	21049-0377	21049-0379	21049-0381	21049-0383	21049-0385	
31	21049-1009	21049-1011	21049-1013	21049-1015	21049-1017	21049-1019	21049-1021	21049-1023	21049-1025	21049-1027	21049-1029	
32	21049-0387	21049-0389	21049-0391	21049-0393	21049-0395	21049-0397	21049-0399	21049-0401	21049-0403	21049-0405	21049-0407	
33	21049-1031	21049-1033	21049-1035	21049-1037	21049-1039	21049-1041	21049-1043	21049-1045	21049-1047	21049-1049	21049-1051	
34	21049-0409	21049-0411	21049-0413	21049-0415	21049-0417	21049-0419	21049-0421	21049-0423	21049-0425	21049-0427	21049-0429	
35	21049-1053	21049-1055	21049-1057	21049-1059	21049-1061	21049-1063	21049-1065	21049-1067	21049-1069	21049-1071	21049-1073	
36	21049-0431	21049-0433	21049-0435	21049-0437	21049-0439	21049-0441	21049-0443	21049-0445	21049-0447	21049-0449	21049-0451	
37	21049-1075	21049-1077	21049-1079	21049-1081	21049-1083	21049-1085	21049-1087	21049-1089	21049-1091	21049-1093	21049-1095	
38	21049-0453	21049-0455	21049-0457	21049-0459	21049-0461	21049-0463	21049-0465	21049-0467	21049-0469	21049-0471	21049-0473	
39	21049-1097	21049-1099	21049-1101	21049-1103	21049-1105	21049-1107	21049-1109	21049-1111	21049-1113	21049-1115	21049-1117	
40	21049-0475	21049-0477	21049-0479	21049-0481	21049-0483	21049-0485	21049-0487	21049-0489	21049-0491	21049-0493	21049-0495	

Custom jumpers available

1.25mm (.049") Pitch Premo-Flex™ Flat Flex Cable Jumpers

**21049
Standard**

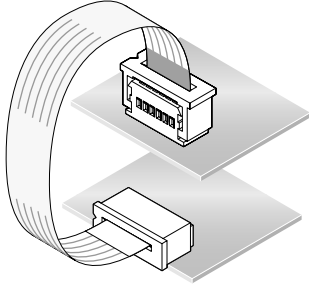

Molex introduces a complete line of 1.25mm (.049") pitch Flat Flex Cable jumpers. These jumpers are used to connect 2 PC boards and terminate to either ZIF or Non-ZIF FFC Connectors.

Molex 1.25mm (.049") Flat Flex Cable jumpers are available in a wide variety of lengths and circuit sizes. These standard lengths are easy to order and feature shorter lead times.

Reference Information

UL Style No.: 2896
Mates With: Any 1.25mm (.049") pitch Molex FFC/FPC connector
Designed In: Millimeters

Electrical
Voltage: 30V
Current: 1.2A

Physical
Strip Length: 5.0mm (.197")
Reinforcement Length: 10.00mm (.394")
Width: (N + 1) 1.25mm
Span: (N - 1) 1.25mm
Margin: 0.85mm (.033")
Conductor Width: 0.80mm (.031")
Conductor Thickness: 0.10mm (.004")
End Thickness: 0.30 ± 0.05mm (.012 ± .002")

Type D FFC Jumpers—Contacts on opposite sides (Preferred version in North America)

Circuits	Order No.											Lead-free
	Overall Length											
	30.00mm (1.181")	51.00mm (2.00")	76.00mm (3.00")	102.00mm (4.00")	127.00mm (5.00")	152.00mm (6.00")	178.00mm (7.00")	203.00mm (8.00")	229.00mm (9.00")	254.00mm (10.00")	305.00mm (12.00")	
4	21049-0700	21049-0702	21049-0704	21049-0706	21049-0708	21049-0710	21049-0712	21049-0714	21049-0716	21049-0718	21049-0720	
5	21049-0722	21049-0724	21049-0726	21049-0728	21049-0730	21049-0732	21049-0734	21049-0736	21049-0738	21049-0740	21049-0742	
6	21049-0102	21049-0104	21049-0106	21049-0108	21049-0110	21049-0112	21049-0114	21049-0116	21049-0118	21049-0120	21049-0122	
7	21049-0744	21049-0746	21049-0748	21049-0750	21049-0752	21049-0754	21049-0756	21049-0758	21049-0760	21049-0762	21049-0764	
8	20149-0124	20149-0126	21049-0128	21049-0130	21049-0132	21049-0134	21049-0136	21049-0138	21049-0140	21049-0142	21049-0144	
9	21049-0766	21049-0768	21049-0770	21049-0772	21049-0774	21049-0776	21049-0778	21049-0780	21049-0782	21049-0784	21049-0786	
10	21049-0146	21049-0148	21049-0150	21049-0152	21049-0154	21049-0156	21049-0158	21049-0160	21049-0162	21049-0164	21049-0166	
11	21049-0788	21049-0790	21049-0792	21049-0794	21049-0796	21049-0798	21049-0800	21049-0802	21049-0804	21049-0806	21049-0808	
12	21049-0168	21049-0170	21049-0172	21049-0174	21049-0176	21049-0178	21049-0180	21049-0182	21049-0184	21049-0186	21049-0188	
13	21049-0810	21049-0812	21049-0814	21049-0816	21049-0818	21049-0820	21049-0822	21049-0824	21049-0826	21049-0828	21049-0830	
14	21049-0190	21049-0192	21049-0194	21049-0196	21049-0198	21049-0200	21049-0202	21049-0204	21049-0206	21049-0208	21049-0210	
15	21049-0832	21049-0834	21049-0836	21049-0838	21049-0840	21049-0842	21049-0844	21049-0846	21049-0848	21049-0850	21049-0852	
16	21049-0212	21049-0214	21049-0216	21049-0218	21049-0220	21049-0222	21049-0224	21049-0226	21049-0228	21049-0230	21049-0232	
17	21049-0854	21049-0856	21049-0858	21049-0860	21049-0862	21049-0864	21049-0866	21049-0868	21049-0870	21049-0872	21049-0874	
18	21049-0234	21049-0236	21049-0238	21049-0240	21049-0242	21049-0244	21049-0246	21049-0248	21049-0250	21049-0252	21049-0254	
19	21049-0876	21049-0878	21049-0880	21049-0882	21049-0884	21049-0886	21049-0888	21049-0890	21049-0892	21049-0894	21049-0896	
20	21049-0256	21049-0258	21049-0260	21049-0262	21049-0264	21049-0266	21049-0268	21049-0270	21049-0272	21049-0274	21049-0276	
21	21049-0898	21049-0900	21049-0902	21049-0904	21049-0906	21049-0908	21049-0910	21049-0912	21049-0914	21049-0916	21049-0918	
22	21049-0278	21049-0280	21049-0282	21049-0284	21049-0286	21049-0288	21049-0290	21049-0292	21049-0294	21049-0296	21049-0298	Yes
23	21049-0920	21049-0922	21049-0924	21049-0926	21049-0928	21049-0930	21049-0932	21049-0934	21049-0936	21049-0938	21049-0940	
24	21049-0300	21049-0302	21049-0304	21049-0306	21049-0308	21049-0310	21049-0312	21049-0314	21049-0316	21049-0318	21049-0320	
25	21049-0942	21049-0944	21049-0946	21049-0948	21049-0950	21049-0952	21049-0954	21049-0956	21049-0958	21049-0960	21049-0962	
26	21049-0322	21049-0324	21049-0326	21049-0328	21049-0330	21049-0332	21049-0334	21049-0336	21049-0338	21049-0340	21049-0342	
27	21049-0964	21049-0966	21049-0968	21049-0970	21049-0972	21049-0974	21049-0976	21049-0978	21049-0980	21049-0982	21049-0984	
28	21049-0344	21049-0346	21049-0348	21049-0350	21049-0352	21049-0354	21049-0356	21049-0358	21049-0360	21049-0362	21049-0364	
29	21049-0986	21049-0988	21049-0990	21049-0992	21049-0994	21049-0996	21049-0998	21049-1000	21049-1002	21049-1004	21049-1006	
30	21049-0366	21049-0368	21049-0370	21049-0372	21049-0374	21049-0376	21049-0378	21049-0380	21049-0382	21049-0384	21049-0386	
31	21049-1008	21049-1010	21049-1012	21049-1014	21049-1016	21049-1018	21049-1020	21049-1022	21049-1024	21049-1026	21049-1028	
32	21049-0388	21049-0390	21049-0392	21049-0394	21049-0396	21049-0398	21049-0400	21049-0402	21049-0404	21049-0406	21049-0408	
33	21049-1030	21049-1032	21049-1034	21049-1036	21049-1038	21049-1040	21049-1042	21049-1044	21049-1046	21049-1048	21049-1050	
34	21049-0410	21049-0412	21049-0414	21049-0416	21049-0418	21049-0420	21049-0422	21049-0424	21049-0426	21049-0428	21049-0430	
35	21049-1052	21049-1054	21049-1056	21049-1058	21049-1060	21049-1062	21049-1064	21049-1066	21049-1068	21049-1070	21049-1072	
36	21049-0432	21049-0434	21049-0436	21049-0438	21049-0440	21049-0442	21049-0444	21049-0446	21049-0448	21049-0450	21049-0452	
37	21049-1074	21049-1076	21049-1078	21049-1080	21049-1082	21049-1084	21049-1086	21049-1088	21049-1090	21049-1092	21049-1094	
38	21049-0454	21049-0456	21049-0458	21049-0460	21049-0462	21049-0464	21049-0466	21049-0468	21049-0470	21049-0472	21049-0474	
39	21049-1096	21049-1098	21049-1100	21049-1102	21049-1104	21049-1106	21049-1108	21049-1110	21049-1112	21049-1114	21049-1116	
40	21049-0476	21049-0478	21049-0480	21049-0482	21049-0484	21049-0486	21049-0488	21049-0490	21049-0492	21049-0494	21049-0496	

Custom jumpers available

1.25mm (.049") Pitch Premo-Flex™ Flat Flex Cable Jumpers

98268
Standard

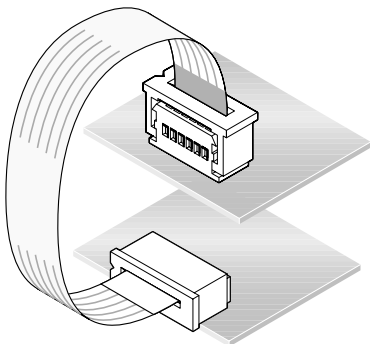

Molex introduces a complete line of 1.25mm (.049") pitch Flat Flex Cable jumpers. These jumpers are used to connect 2 PC boards and terminate to either ZIF or Non-ZIF FFC connectors.

Molex 1.25mm (.049") Flat Flex Cable jumpers are available in a wide variety of lengths and circuit sizes. These standard lengths are easy to order and feature shorter lead times.

We are also able to offer customized lengths and circuit sizes.

Reference Information

Product Specification: PS-98268-001
Packaging: Box
UL Style No.: 20706
Mates With: Any 1.25mm (.049") Pitch Molex FFC/FPC connector
Designed In: Millimeters

Electrical
Voltage: 60V
Current: 1.4A

Physical
Strip Length: 5.0mm (.197")
Reinforcement Length: 10.0mm (.394")
Width: (N + 1) 1.25mm
Span: (N - 1) 1.25mm
Margin: 0.85mm (.033")
Conductor Width: 0.80mm (.031")
Conductor Thickness: 0.10mm (.004")
End Thickness: 0.30 ± 0.05mm (.012 ± .002")

Type A Jumpers—Contacts on same side (Preferred version in Europe)

Circuits	Order No.											Lead-free
	Overall Length											
	30mm (1.81")	51mm (2.00")	76mm (3.00")	102mm (4.00")	127mm (5.00")	152mm (6.00")	178mm (7.00")	203mm (8.00")	229mm (9.00")	254mm (10.00")	305mm (12.00")	
4	98268-0701	98268-0703	98268-0705	98268-0707	98268-0709	98268-0711	98268-0713	98268-0715	98268-0717	98268-0719	98268-0721	
5	98268-0723	98268-0725	98268-0727	98268-0729	98268-0731	98268-0733	98268-0735	98268-0737	98268-0739	98268-0741	98268-0743	
6	98268-0101	98268-0103	98268-0105	98268-0107	98268-0109	98268-0111	98268-0113	98268-0115	98268-0117	98268-0119	98268-0121	
7	98268-0745	98268-0747	98268-0749	98268-0751	98268-0753	98268-0755	98268-0757	98268-0759	98268-0761	98268-0763	98268-0765	
8	98268-0123	98268-0125	98268-0127	98268-0129	98268-0131	98268-0133	98268-0135	98268-0137	98268-0139	98268-0141	98268-0143	
9	98268-0767	98268-0769	98268-0771	98268-0773	98268-0775	98268-0777	98268-0779	98268-0781	98268-0783	98268-0785	98268-0787	
10	98268-0145	98268-0147	98268-0149	98268-0151	98268-0153	98268-0155	98268-0157	98268-0159	98268-0161	98268-0163	98268-0165	
11	98268-0789	98268-0791	98268-0793	98268-0795	98268-0797	98268-0799	98268-0801	98268-0803	98268-0805	98268-0807	98268-0809	
12	98268-0167	98268-0169	98268-0171	98268-0173	98268-0175	98268-0177	98268-0179	98268-0181	98268-0183	98268-0185	98268-0187	
13	98268-0811	98268-0813	98268-0815	98268-0817	98268-0819	98268-0821	98268-0823	98268-0825	98268-0827	98268-0829	98268-0831	
14	98268-0189	98268-0191	98268-0193	98268-0195	98268-0197	98268-0199	98268-0201	98268-0203	98268-0205	98268-0207	98268-0209	
15	98268-0833	98268-0835	98268-0837	98268-0839	98268-0841	98268-0843	98268-0845	98268-0847	98268-0849	98268-0851	98268-0853	
16	98268-0211	98268-0213	98268-0215	98268-0217	98268-0219	98268-0221	98268-0223	98268-0225	98268-0227	98268-0229	98268-0231	
17	98268-0855	98268-0857	98268-0859	98268-0861	98268-0863	98268-0865	98268-0867	98268-0869	98268-0871	98268-0873	98268-0875	
18	98268-0233	98268-0235	98268-0237	98268-0239	98268-0241	98268-0243	98268-0245	98268-0247	98268-0249	98268-0251	98268-0253	
19	98268-0877	98268-0879	98268-0881	98268-0883	98268-0885	98268-0887	98268-0889	98268-0891	98268-0893	98268-0895	98268-0897	
20	98268-0255	98268-0257	98268-0259	98268-0261	98268-0263	98268-0265	98268-0267	98268-0269	98268-0271	98268-0273	98268-0275	
21	98268-0899	98268-0901	98268-0903	98268-0905	98268-0907	98268-0909	98268-0911	98268-0913	98268-0915	98268-0917	98268-0919	
22	98268-0277	98268-0279	98268-0281	98268-0283	98268-0285	98268-0287	98268-0289	98268-0291	98268-0293	98268-0295	98268-0297	
23	98268-0921	98268-0923	98268-0925	98268-0927	98268-0929	98268-0931	98268-0933	98268-0935	98268-0937	98268-0939	98268-0941	
24	98268-0299	98268-0301	98268-0303	98268-0305	98268-0307	98268-0309	98268-0311	98268-0313	98268-0315	98268-0317	98268-0319	
25	98268-0943	98268-0945	98268-0947	98268-0949	98268-0951	98268-0953	98268-0955	98268-0957	98268-0959	98268-0961	98268-0963	
26	98268-0321	98268-0323	98268-0325	98268-0327	98268-0329	98268-0331	98268-0333	98268-0335	98268-0337	98268-0339	98268-0341	
27	98268-0965	98268-0967	98268-0969	98268-0971	98268-0973	98268-0975	98268-0977	98268-0979	98268-0981	98268-0983	98268-0985	
28	98268-0343	98268-0345	98268-0347	98268-0349	98268-0351	98268-0353	98268-0355	98268-0357	98268-0359	98268-0361	98268-0363	
29	98268-0987	98268-0989	98268-0991	98268-0993	98268-0995	98268-0997	98268-0999	98268-1001	98268-1003	98268-1005	98268-1007	
30	98268-0365	98268-0367	98268-0369	98268-0371	98268-0373	98268-0375	98268-0377	98268-0379	98268-0381	98268-0383	98268-0385	
31	98268-1009	98268-1011	98268-1013	98268-1015	98268-1017	98268-1019	98268-1021	98268-1023	98268-1025	98268-1027	98268-1029	
32	98268-0387	98268-0389	98268-0391	98268-0393	98268-0395	98268-0397	98268-0399	98268-0401	98268-0403	98268-0405	98268-0407	
33	98268-1031	98268-1033	98268-1035	98268-1037	98268-1039	98268-1041	98268-1043	98268-1045	98268-1047	98268-1049	98268-1051	
34	98268-0409	98268-0411	98268-0413	98268-0415	98268-0417	98268-0419	98268-0421	98268-0423	98268-0425	98268-0427	98268-0429	
35	98268-1053	98268-1055	98268-1057	98268-1059	98268-1061	98268-1063	98268-1065	98268-1067	98268-1069	98268-1071	98268-1073	
36	98268-0431	98268-0433	98268-0435	98268-0437	98268-0439	98268-0441	98268-0443	98268-0445	98268-0447	98268-0449	98268-0451	
37	98268-1075	98268-1077	98268-1079	98268-1081	98268-1083	98268-1085	98268-1087	98268-1089	98268-1091	98268-1093	98268-1095	
38	98268-0453	98268-0455	98268-0457	98268-0459	98268-0461	98268-0463	98268-0465	98268-0467	98268-0469	98268-0471	98268-0473	
39	98268-1097	98268-1099	98268-1101	98268-1103	98268-1105	98268-1107	98268-1109	98268-1111	98268-1113	98268-1115	98268-1117	
40	98268-0475	98268-0477	98268-0479	98268-0481	98268-0483	98268-0485	98268-0487	98268-0489	98268-0491	98268-0493	98268-0495	

1.25mm (.049") Pitch Premo-Flex™ Flat Flex Cable Jumpers

98268
Standard

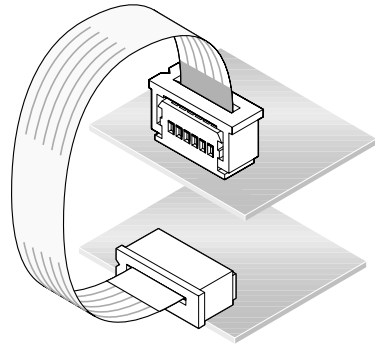

Molex introduces a complete line of 1.25mm (.049") pitch Flat Flex Cable jumpers. These jumpers are used to connect 2 PC boards and terminate to either ZIF or Non-ZIF FFC connectors.

Molex 1.25mm (.049") Flat Flex Cable jumpers are available in a wide variety of lengths and circuit sizes. These standard lengths are easy to order and feature shorter lead times.

We are also able to offer customized lengths and circuit sizes.

Reference Information

Product Specification: PS-98268-001

Packaging: Box

UL Style No.: 20706

Mates With: Any 1.25mm (.049") Pitch Molex FFC/FPC connector

Designed In: Millimeters

Electrical

Voltage: 60V

Current: 1.4A

Physical

Strip Length: 5.0mm (.197")

Reinforcement Length: 10.0mm (.394")

Width: (N + 1) 1.25mm

Span: (N - 1) 1.25mm

Margin: 0.85mm (.033")

Conductor Width: 0.80mm (.031")

Conductor Thickness: 0.10mm (.004")

End Thickness: 0.30 ± 0.05mm (.012 ± .002")

Type D Jumpers—Contacts on opposite side (Preferred version in Europe)

Circuits	Order No.											Lead-free
	Overall Length											
	30mm (1.81")	51mm (2.00")	76mm (3.00")	102mm (4.00")	127mm (5.00")	152mm (6.00")	178mm (7.00")	203mm (8.00")	229mm (9.00")	254mm (10.00")	305mm (12.00")	
4	98268-0700	98268-0702	98268-0704	98268-0706	98268-0708	98268-0710	98268-0712	98268-0714	98268-0716	98268-0718	98268-0720	
5	98268-0722	98268-0724	98268-0726	98268-0728	98268-0730	98268-0732	98268-0734	98268-0736	98268-0738	98268-0740	98268-0742	
6	98268-0102	98268-0104	98268-0106	98268-0108	98268-0110	98268-0112	98268-0114	98268-0116	98268-0118	98268-0120	98268-0122	
7	98268-0744	98268-0746	98268-0748	98268-0750	98268-0752	98268-0754	98268-0756	98268-0758	98268-0760	98268-0762	98268-0764	
8	98268-0124	98268-0126	98268-0128	98268-0130	98268-0132	98268-0134	98268-0136	98268-0138	98268-0140	98268-0142	98268-0144	
9	98268-0766	98268-0768	98268-0770	98268-0772	98268-0774	98268-0776	98268-0778	98268-0780	98268-0782	98268-0784	98268-0786	
10	98268-0146	98268-0148	98268-0150	98268-0152	98268-0154	98268-0156	98268-0158	98268-0160	98268-0162	98268-0164	98268-0166	
11	98268-0788	98268-0790	98268-0792	98268-0794	98268-0796	98268-0798	98268-0800	98268-0802	98268-0804	98268-0806	98268-0808	
12	98268-0168	98268-0170	98268-0172	98268-0174	98268-0176	98268-0178	98268-0180	98268-0182	98268-0184	98268-0186	98268-0188	
13	98268-0810	98268-0812	98268-0814	98268-0816	98268-0818	98268-0820	98268-0822	98268-0824	98268-0826	98268-0828	98268-0830	
14	98268-0190	98268-0192	98268-0194	98268-0196	98268-0198	98268-0200	98268-0202	98268-0204	98268-0206	98268-0208	98268-0210	
15	98268-0832	98268-0834	98268-0836	98268-0838	98268-0840	98268-0842	98268-0844	98268-0846	98268-0848	98268-0850	98268-0852	
16	98268-0212	98268-0214	98268-0216	98268-0218	98268-0220	98268-0222	98268-0224	98268-0226	98268-0228	98268-0230	98268-0232	
17	98268-0854	98268-0856	98268-0858	98268-0860	98268-0862	98268-0864	98268-0866	98268-0868	98268-0870	98268-0872	98268-0874	
18	98268-0234	98268-0236	98268-0238	98268-0240	98268-0242	98268-0244	98268-0246	98268-0248	98268-0250	98268-0252	98268-0254	
19	98268-0876	98268-0878	98268-0880	98268-0882	98268-0884	98268-0886	98268-0888	98268-0890	98268-0892	98268-0894	98268-0896	
20	98268-0256	98268-0258	98268-0260	98268-0262	98268-0264	98268-0266	98268-0268	98268-0270	98268-0272	98268-0274	98268-0276	
21	98268-0898	98268-0900	98268-0902	98268-0904	98268-0906	98268-0908	98268-0910	98268-0912	98268-0914	98268-0916	98268-0918	
22	98268-0278	98268-0280	98268-0282	98268-0284	98268-0286	98268-0288	98268-0290	98268-0292	98268-0294	98268-0296	98268-0298	Yes
23	98268-0920	98268-0922	98268-0924	98268-0926	98268-0928	98268-0930	98268-0932	98268-0934	98268-0936	98268-0938	98268-0940	
24	98268-0300	98268-0302	98268-0304	98268-0306	98268-0308	98268-0310	98268-0312	98268-0314	98268-0316	98268-0318	98268-0320	
25	98268-0942	98268-0944	98268-0946	98268-0948	98268-0950	98268-0952	98268-0954	98268-0956	98268-0958	98268-0960	98268-0962	
26	98268-0322	98268-0324	98268-0326	98268-0328	98268-0330	98268-0332	98268-0334	98268-0336	98268-0338	98268-0340	98268-0342	
27	98268-0964	98268-0966	98268-0968	98268-0970	98268-0972	98268-0974	98268-0976	98268-0978	98268-0980	98268-0982	98268-0984	
28	98268-0344	98268-0346	98268-0348	98268-0350	98268-0352	98268-0354	98268-0356	98268-0358	98268-0360	98268-0362	98268-0364	
29	98268-0986	98268-0988	98268-0990	98268-0992	98268-0994	98268-0996	98268-0998	98268-1000	98268-1002	98268-1004	98268-1006	
30	98268-0366	98268-0368	98268-0370	98268-0372	98268-0374	98268-0376	98268-0378	98268-0380	98268-0382	98268-0384	98268-0386	
31	98268-1008	98268-1010	98268-1012	98268-1014	98268-1016	98268-1018	98268-1020	98268-1022	98268-1024	98268-1026	98268-1028	
32	98268-0388	98268-0390	98268-0392	98268-0394	98268-0396	98268-0398	98268-0400	98268-0402	98268-0404	98268-0406	98268-0408	
33	98268-1030	98268-1032	98268-1034	98268-1036	98268-1038	98268-1040	98268-1042	98268-1044	98268-1046	98268-1048	98268-1050	
34	98268-0410	98268-0412	98268-0414	98268-0416	98268-0418	98268-0420	98268-0422	98268-0424	98268-0426	98268-0428	98268-0430	
35	98268-1052	98268-1054	98268-1056	98268-1058	98268-1060	98268-1062	98268-1064	98268-1066	98268-1068	98268-1070	98268-1072	
36	98268-0432	98268-0434	98268-0436	98268-0438	98268-0440	98268-0442	98268-0444	98268-0446	98268-0448	98268-0450	98268-0452	
37	98268-1074	98268-1076	98268-1078	98268-1080	98268-1082	98268-1084	98268-1086	98268-1088	98268-1090	98268-1092	98268-1094	
38	98268-0454	98268-0456	98268-0458	98268-0460	98268-0462	98268-0464	98268-0466	98268-0468	98268-0470	98268-0472	98268-0474	
39	98268-1096	98268-1098	98268-1100	98268-1102	98268-1104	98268-1106	98268-1108	98268-1110	98268-1112	98268-1114	98268-1116	
40	98268-0476	98268-0478	98268-0480	98268-0482	98268-0484	98268-0486	98268-0488	98268-0490	98268-0492	98268-0494	98268-0496	

Ribbon Cable Connectors

1.27mm (.050") Pitch – Picoflex™ PF-50

- IDT Connectors F-2
- Headers F-3 to F-7
- Custom Cable Harness F-7 to F-8

Connectors for 1.27mm (.050") Pitch Ribbon Cable – QF-50™

- Receptacles F-11 to F-12
- Strain Relief F-12
- Shrouded Headers F-13 to F-16

2.54mm (.010") Pitch Connectors – SL™ F-17

Wire Traps

2.00mm (.079") Pitch F-18

Visit www.molex.com to access more part numbers and product information, download sales drawings, product specifications, 3D models, place sample requests, and more.

1.27mm (.050") Pitch Picoflex™ PF-50 Connector

90327
Low Profile, IDT

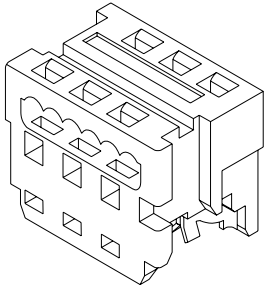

Features and Benefits

- 1-piece housing assures precise positioning of cable
- Molded-in polarization
- 4 points of contact with ribbon cable
- Preloaded contacts
- Accepts 28 or 26 AWG (7 strand) ribbon cable
- Tape option for high-speed termination, contact Molex for part numbers

Reference Information

Product Specification: PS-99020-0011
 Packaging: Bag (tape optional)
 Tooling Information: See end of section
 UL File No.: E29179
 CSA File No.: LR19980-181
 Mates With: 90325, 90779, 90800, 90814, 91330 and 91714
 Use Molex Cable: 6800, 8863 and 40158
 Designed In: Millimeters

Electrical

Voltage: 250V
 Current: 1.2A
 Contact Resistance: 15 milliohms max.
 Dielectric Withstanding Voltage: 750V rms
 Insulation Resistance: 1000 Megohms min.

Mechanical

Mating Force: Tin—1.7N; Gold—1.1N
 Unmating Force: Tin—0.25N; Gold—0.25N
 Durability: Tin—30 cycles max.
 Gold—100 cycles max. (using extraction tool)

Physical

Housing: White polyester, UL 94V-0
 Contact: Phosphor Bronze Alloy
 Plating: See Table
 Cable Accommodation: 26 and 28 AWG stranded

Circuits	Order No.		Lead-free
	Plating 1	Plating 2	
4	90327-0304	90327-3304	Yes
6	90327-0306	90327-3306	
8	90327-0308	90327-3308	
10	90327-0310	90327-3310	
12	90327-0312	90327-3312	
14	90327-0314	90327-3314	

Plating 1: 2-4µm (80-160µ") Tin
 Plating 2: 0.76µm (30µ") Select Gold

Circuits	Order No.		Lead-free
	Plating 1	Plating 2	
16	90327-0316	90327-3316	Yes
18	90327-0318	90327-3318	
20	90327-0320	90327-3320	
22	90327-0322	90327-3322	
24	90327-0324	90327-3324	
26	90327-0326	90327-3326	

1.27mm (.050") Pitch Picoflex™ PF-50 Connector

90584
Low Profile, IDT
Board-In

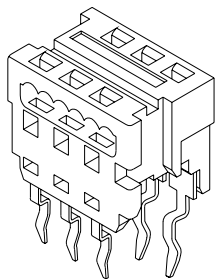

Features and Benefits

- For permanent wire-to-board connections
- Kinked solder tails for board retention during solder process
- Fits same board layout pattern as male header
- Height from board when soldered and terminated only 6.40mm (.252")
- 2 points of contact in IDT section
- Accepts 26 to 28 AWG, 7 strands, ribbon cable

Reference Information

Product Specification: PS-99020-0011
 Packaging: Tube (2 options)
 Tooling Information: See end of section
 Designed In: Millimeters

Electrical

Voltage: 250V
 Current: 1.2A
 Contact Resistance: 15 milliohms max.
 Dielectric Withstanding Voltage: 750V
 Insulation Resistance: 1000 Megohms min.

Physical

Housing: White polyester, UL 94V-0
 Contact: Phosphor Bronze Alloy
 Plating: 2-4µm (80-160µ") Tin over Nickel

Circuits	Order No.		Lead-free
	Individual Tube	Stacked Tube	
4	90584-1304	90584-2304	Yes
6	90584-1306	90584-2306	
8	90584-1308	90584-2308	
10	90584-1310	90584-2310	
12	90584-1312	90584-2312	
14	90584-1314	90584-2314	

Note: Stacked tube is a group of 7 individual tubes in a stack

Circuits	Order No.		Lead-free
	Individual Tube	Stacked Tube	
16	90584-1316	90584-2316	Yes
18	90584-1318	90584-2318	
20	90584-1320	90584-2320	
22	90584-1322	90584-2322	
24	90584-1324	90584-2324	
26	90584-1326	90584-2326	

1.27mm (.050") Pitch Picoflex™ PF-50 Crimp Terminal

91821

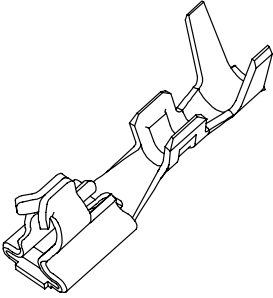

Features and Benefits

- High current capability
- Two points of contact with male pin
- Can be used in low current/high temperature/high vibration applications

Reference Information

Product Specification: PS-99020-0011
 Packaging: Reel
 Mates With: 90814, 90325, 90779, 90800, 91714 and 91330
 Use With: 91935
 Designed In: Millimeters

Electrical

Voltage: 250V
 Current: 2.4A
 Contact Resistance: 15 milliohms max.
 Dielectric Withstanding Voltage: 750V rms
 Insulation Resistance: 1000 Megohms min.

Mechanical

Contact Insertion Force: 1.7N
 Contact Retention to Housing: 15N
 Wire Pull-Out Force: 10 to 30N
 Durability: 30 cycles min.

Physical

Contact: Phosphor Bronze
 Plating: Contact Area—Tin/Gold
 Underplating—Nickel
 Insulation Diameter: 1.50mm max.
 Strip Length: 2.00 to 2.50mm
 Wire Gauge: 24 to 28AWG

Order No.		Lead-free
Tin	Gold	
91821-0001	91821-0003	Yes

1.27mm (.050") Pitch Picoflex™ PF-50 Crimp Housing

91935

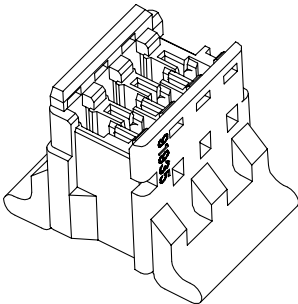

Features and Benefits

- Glow wire compatible 750°C
- Termination windows for visual check on crimp termination
- Friction lock
- Polarized housing
- Finger grips for ease of use

Reference Information

Product Specification: PS-99020-0011
 Packaging: Bag
 Mates With: 90814, 90325, 90779, 90800, 91714 and 91330
 Use With: 91821
 Designed In: Millimeters

Electrical

Voltage: 250V
 Current: 2.4A
 Contact Resistance: 15 milliohms max.
 Dielectric Withstanding Voltage: 750V rms
 Insulation Resistance: 1000 Megohms min.

Mechanical

Contact Insertion Force: 1.7N
 Contact Retention to Housing: 15N
 Durability: 30 cycles min.

Physical

Housing: Natural 30% glass-filled PET, UL 94V-0

Circuits	Order No.	Lead-free
4	91935-9004	Yes
6	91935-9006	
8	91935-9008	
10	91935-9010	
12	91935-9012	
14	91935-9014	

Circuits	Order No.	Lead-free
16	91935-9016	Yes
18	91935-9018	
20	91935-9020	
22	91935-9022	
24	91935-9024	
26	91935-9026	

1.27mm (.050") Pitch Picoflex™ PF-50 Header

90325
Low Profile

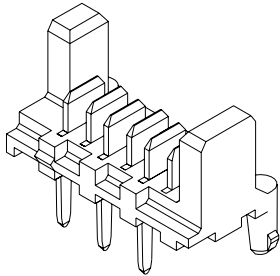

Features and Benefits

- Polarizing side posts and PCB pegs
- Stamped contacts with in-line, flat blades
- 2 points of contact with female terminal
- Rigid, staggered solder tails
- Friction lock
- Tube option packaging for robotic delivery, contact Molex for part numbers

Reference Information

Product Specification: PS-99020-0011
 Packaging: Bag or tube
 UL File No.: E29179
 CSA File No.: LR19980-181
 Mates With: 90327 and 91935
 Designed In: Millimeters

Electrical

Voltage: 250V
 Current: 1.2A
 Contact Resistance: 15 milliohms max.
 Dielectric Withstanding Voltage: 750V rms
 Insulation Resistance: 1000 Megohms min.

Mechanical

Contact Retention to Housing: 7N
 Mating Force: Tin—1.7N; Gold—1.1N
 Unmating Force: Tin—0.25N; Gold—0.25N
 Durability: Tin—30 cycles max.
 Gold—100 cycles max. (using extraction tool)

Physical

Housing: Black 15% glass-filled polyester, UL 94V-0
 Contact: Brass
 Plating: See Table

Circuits	Order No.		Lead-free
	Plating 1	Plating 2	
4	90325-0004	90325-3004	Yes
6	90325-0006	90325-3006	
8	90325-0008	90325-3008	
10	90325-0010	90325-3010	
12	90325-0012	90325-3012	
14	90325-0014	90325-3014	
16	90325-0016	90325-3016	

Plating 1: 3-5µm (120-200µ") Tin
 Plating 2: 0.76µm (30µ") Select Gold

Circuits	Order No.		Lead-free
	Plating 1	Plating 2	
14	90325-0014	90325-3014	Yes
16	90325-0016	90325-3016	
18	90325-0018	90325-3018	
20	90325-0020	90325-3020	
22	90325-0022	90325-3022	
24	90325-0024	90325-3024	
26	90325-0026	90325-3026	

1.27mm (.050") Pitch Picoflex™ PF-50 Header

90814
SMT

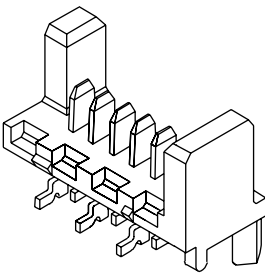

Features and Benefits

- Polarizing side posts and PCB pegs
- Stamped SMT contacts with in-line, flat blades
- 2 points of contact with female terminal
- Rigid, staggered SMT solder tails
- Friction lock

Reference Information

Product Specification: PS-99020-0011
 Packaging: Tube or blister pack (contact Molex)
 Mates With: 90327 and 91935
 Designed In: Millimeters

Electrical

Voltage: 250V
 Current: 1.2A
 Contact Resistance: 15 milliohms max.
 Dielectric Withstanding Voltage: 750V rms
 Insulation Resistance: 1000 Megohms min.

Mechanical

Contact Retention to Housing: 7N
 Mating Force: Tin—1.7N; Gold—1.1N
 Unmating Force: Tin—0.25N; Gold—0.25N
 Durability: Tin—30 cycles max.
 Gold—100 cycles max. (using extraction tool)

Physical

Housing: Natural 30% glass-filled nylon, UL 94V-0
 Contact: Brass
 Plating: See Table

Circuits	Order No.				Lead-free
	Tube Pack		Blister Pack		
	120-200µ" (3-5µm) Tin	30µ" (0.76µm) Select Gold	120-200µ" (3-5µm) Tin	30µ" (0.76µm) Select Gold	
4	90814-0804	90814-3804	90814-0904	90814-3904	Yes
6	90814-0806	90814-3806	90814-0906	90814-3906	
8	90814-0808	90814-3808	90814-0908	90814-3908	
10	90814-0810	90814-3810	90814-0910	90814-3910	
12	90814-0812	90814-3812	90814-0912	90814-3912	
14	90814-0814	90814-3814	90814-0914	90814-3914	
16	90814-0816	90814-3816	90814-0916	90814-3916	
18	90814-0818	90814-3818	90814-0918	90814-3918	
20	90814-0820	90814-3820	90814-0920	90814-3920	
22	90814-0822	90814-3822	90814-0922	90814-3922	
24	90814-0824	90814-3824	90814-0924	90814-3924	
26	90814-0826	90814-3826	90814-0926	90814-3926	

1.27mm (.050") Pitch Picoflex™ PF-50 Header

91330
Low Profile, Bottom Entry
SMT

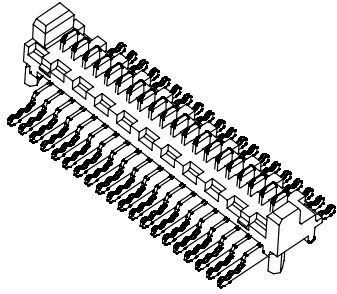

Features and Benefits

- Polarizing side posts and PCB pegs
- Stamped SMT contacts
- Two points of contact with female terminal
- Friction lock
- Can be used in RoHS lead-free process up to 260°C
- Kapton tape for pick and place during SMT assembly
- Low profile application which creates a double-sided board effect with a single-side SMT process

Reference Information

Product Specification: PS-99020-0011
Packaging: Tape and Reel
Mates With: 90327 and 91935
Designed In: Millimeters

Electrical

Voltage: 250V
Current: 1.2 to 2.4A
Contact Resistance: 15 milliohms max.
Dielectric Withstanding Voltage: 750V rms
Insulation Resistance: 1000 Megohms min.

Mechanical

Contact Insertion Force: 1.7N
Contact Retention to Housing: 7N
Durability: 30 cycles max.

Physical

Housing: Natural 30% glass-filled Nylon, UL 94V-0
Contact: Brass
Plating: Contact Area—Tin
Solder Tail Area—Tin
Underplating—Tin
PCB Thickness: 1.57mm ±0.13

Circuits	Order No.	Lead-free
6	91330-0006	Yes
8	91330-0008	
10	91330-0010	
12	91330-0012	
14	91330-0014	
16	91330-0016	

Circuits	Order No.	Lead-free
18	91330-0018	Yes
20	91330-0020	
22	91330-0022	
24	91330-0024	
26	91330-0026	

1.27mm (.050") Pitch Picoflex™ PF-50 Header

90779
Low Profile
High Temperature

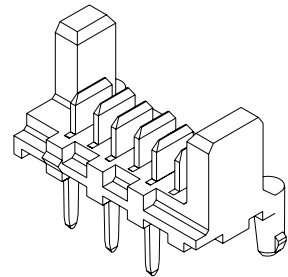

Features and Benefits

- Polarizing side posts and PCB pegs
- Stamped contacts with in-line, flat blades
- 2 points of contact with female terminal
- Rigid, staggered solder tails
- Friction Lock
- High-temperature Surface Mount Compatible housing

Reference Information

Product Specification: PS-99020-0011
Packaging: Bag (contact Molex for tube part numbers)
Mates With: 90327 and 91935
Designed In: Millimeters

Electrical

Voltage: 250V
Current: 1.2A
Contact Resistance: 15 milliohms max.
Dielectric Withstanding Voltage: 750V rms
Insulation Resistance: 1000 Megohms min.

Mechanical

Contact Retention to Housing: 7N
Mating Force: Tin—1.7N; Gold—1.1N
Unmating Force: Tin—0.25N; Gold—0.25N
Durability: Tin—30 cycles max.
Gold—100 cycles max. (using extraction tool)

Physical

Housing: Natural 30% glass-filled nylon, UL 94V-0
Contact: Brass
Plating: See Table

Circuits	Order No.		Lead-free
	Plating 1	Plating 2	
4	90779-0001	90779-3001	Yes
6	90779-0002	90779-3002	
8	90779-0003	90779-3003	
10	90779-0004	90779-3004	
12	90779-0005	90779-3005	
14	90779-0006	90779-3006	

Plating 1: Tin 4-6µm (160-240µ")
Plating 2: Select Gold .76µm (30µ")

Circuits	Order No.		Lead-free
	Plating 1	Plating 2	
16	90779-0007	90779-3007	Yes
18	90779-0008	90779-3008	
20	90779-0010	90779-3010	
22	90779-0011	90779-3011	
24	90779-0012	90779-3012	
26	90779-0013	90779-3013	

1.27mm (.050") Pitch Picoflex™ PF-50 Header

90800
Right Angle, Low Profile

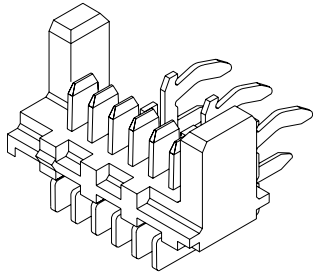

Features and Benefits

- Polarizing side posts
- Stamped contacts
- 2 points of contact with female terminal
- Kinked solder tails for board retention during solder process
- Friction lock

Reference Information

Packaging: Tube
Tooling Information: See end of section
Mates With: 90327
Designed In: Millimeters

Electrical

Voltage: 250V
Current: 1.2A
Contact Resistance: 15 milliohms max.
Dielectric Withstanding Voltage: 750V
Insulation Resistance: 1000 Megohms min.

Mechanical

Contact Retention to Housing: 7N
Mating Force: Tin—1.7N
Unmating Force: Tin—0.25N
Durability: Tin—30 cycles max. (using extraction tool)

Physical

Housing: Black 15% glass-filled polyester, UL 94V-0
Contact: Brass
Plating: See Table

Circuits	Order No.		Lead-free
	Plating 1	Plating 2	
4	90800-0004	90800-3004	Yes
6	90800-0006	90800-3006	
8	90800-0008		
10	90800-0010		
12	90800-0012	90800-3012	
14	90800-0014	90800-3014	

Plating 1: Tin 3-5µm Tin over Nickel
Plating 2: Select Gold .76µm (30µ")

Circuits	Order No.		Lead-free
	Plating 1	Plating 2	
16	90800-0016		Yes
18	90800-0018		
20	90800-0020	90800-3020	
22	90800-0022		
24	90800-0024	90800-3024	
26	90800-0026	90800-3026	

1.27mm (.050") Pitch Picoflex™ PF-50 Header

91714
Right Angle, Low Profile
High Temperature
Through Hole

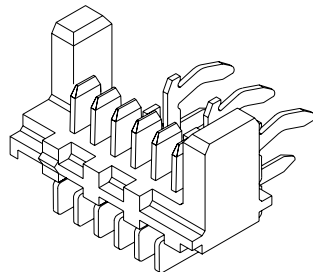

Features and Benefits

- Polarizing side posts
- Stamped contacts
- Two points of contact with female terminal
- Kinked solder tails for board retention during solder process
- Friction lock
- High-temperature Surface Mount Compatible housing

Reference Information

Product Specification: PS-99020-0011
Packaging: Tube
Mates With: 90327 and 91935
Designed In: Millimeters

Mechanical

Contact Insertion Force: 1.7N
Contact Retention to Housing: 7N
Durability: 30 cycles min.

Physical

Housing: Natural 30% glass-filled Nylon, UL 94V-0
Contact: Brass
Plating: Contact Area—Tin/Gold
Solder Tail Area—Tin
Underplating—Nickel
PCB Thickness: 1.60mm ±0.20

Circuits	Order No.		Lead-free
	Tin	Gold	
4	91714-0004	91714-3004	Yes
6	91714-0006	91714-3006	
8	91714-0008	91714-3008	
10	91714-0010	91714-3010	
12	91714-0012	91714-3012	
14	91714-0014	91714-3014	

Circuits	Order No.		Lead-free
	Tin	Gold	
16	91714-0016	91714-3016	Yes
18	91714-0018	91714-3018	
20	91714-0020	91714-3020	
22	91714-0022	91714-3022	
24	91714-0024	91714-3024	
26	91714-0026	91714-3026	

1.27mm (.050") Pitch Picoflex™ PF-50 Latched Header

90816
SMT

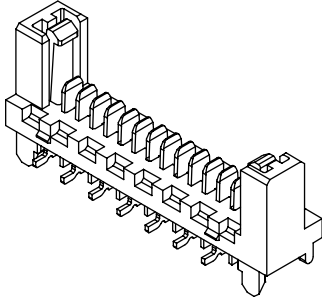

Features and Benefits

- Positive latch for increased retention
- Polarizing side posts and PCB pegs
- Stamped SMT contacts with in-line, flat blades
- 2 points of contact with female terminal
- Rigid, staggered SMT solder tails
- Can be used in RMS lead-free process up to 260°

Reference Information

Product Specification: PS-99020-0011
Packaging: Tube or blister pack (contact Molex)
Mates With: 90327
Designed In: Millimeters

Electrical

Voltage: 250V
Current: 1.2A
Contact Resistance: 15 milliohms max.
Dielectric Withstanding Voltage: 750V rms
Insulation Resistance: 1000 Megohms min.

Mechanical

Contact Retention to Housing: 7N
Mating Force: Tin—1.7N; Gold—1.1N
Unmating Force: Tin—0.25N; Gold—0.25N
Durability: Tin—5 cycles max. (using extraction tool)
Gold—5 cycles max. (using extraction tool)

Physical

Housing: Black Polyphthalamide 30% glass-filled
Contact: Brass
Plating: See Table

Circuits	Order No.				Lead-free
	Tube Pack		Blister Pack		
	120-200 μ m (3-5 μ m) Tin	30 μ m (0.76 μ m) Select Gold	120-200 μ m (3-5 μ m) Tin	30 μ m (0.76 μ m) Select Gold	
4	90816-0004	90816-3004			Yes
6	90816-0006	90816-3006	90816-0206	90816-3206	
8	90816-0008	90816-3008	90816-0208	90816-3208	
10	90816-0010	90816-3010	90816-0210	90816-3210	
12	90816-0012	90816-3012	90816-0212	90816-3212	
14	90816-0014	90816-3014	90816-0214	90816-3214	
16	90816-0016	90816-3016	90816-0216	90816-3216	
18	90816-0018	90816-3018	90816-0218	90816-3218	
20	90816-0020	90816-3020	90816-0220	90816-3220	
22	90816-0022	90816-3022	90816-0222	90816-3222	
24	90816-0024	90816-3024	90816-0224	90816-3224	
26	90816-0026	90816-3026	90816-0226	90816-3226	

1.27mm (.050") Pitch Picoflex™ PF-50 Custom Cable Harness

92315

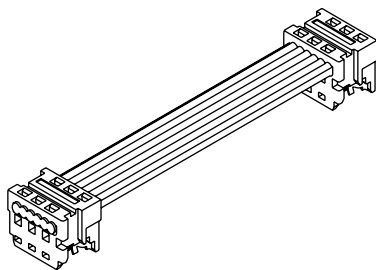

Features and Benefits

- Cable assembly with two 90327 connectors, C-style
- Sizes 4 to 26
- UL 2651, 28 AWG (7 strand) ribbon cable
- Lengths from 6 to 120cm

Reference Information

Packaging: Bag
Mates With: 90325, 90800, 90814, 90715 and 90779
Designed In: Millimeters

Electrical

Voltage: 250V
Current: 1.2A

Mechanical

Mating Force: 1.7N
Unmating Force: 0.25N
Durability: 30 cycles max.

Physical

Housing: 6/6 nylon, UL 94V-0
Contact: Phosphor Bronze Alloy
Plating: 3 to 6 μ m Tin
Insulation: Cable—Gray PVC
Wire Range: 28 AWG

Circuits	Order No.	Lead-free
4	92315-04XX	Yes
6	92315-06XX	
8	92315-08XX	
10	92315-10XX	
12	92315-12XX	
14	92315-14XX	

Circuits	Order No.	Lead-free
16	92315-16XX	Yes
18	92315-18XX	
20	92315-20XX	
22	92315-22XX	
24	92315-24XX	
26	92315-26XX	

Length	XX
6-99cm	06-99
100cm	01
105cm	02
110cm	03
115cm	04
120cm	05

Replace XX with length in cm (min. 6cm, max. 120cm), see table
Example: 92315-0832 is a cable with two 90327-0308, 32cm long

1.27mm (.050") Pitch Picoflex™ PF-50 Custom Cable Harness

92317

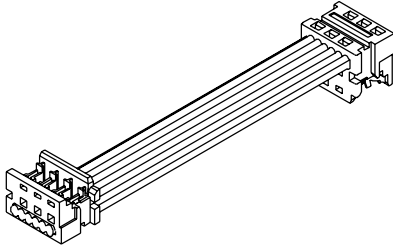

Features and Benefits

- Cable assembly with two 90327 connectors, Z-style
- Sizes 4 to 26
- UL 2651, 28 AWG (7 strand) ribbon cable
- Lengths from 6 to 120cm

Reference Information

Packaging: Bag
Mates With: 90325, 90800, 90814, 90715 and 90779
Designed In: Millimeters

Electrical

Voltage: 250V
Current: 1.2A

Mechanical

Mating Force: 1.7N
Unmating Force: 0.25N
Durability: 30 cycles max.

Physical

Housing: 6/6 nylon, UL 94V-0
Contact: Phosphor Bronze Alloy
Plating: 3 to 6µ" Tin
Insulation: Cable—Gray PVC
Wire Range: 28 AWG

Circuits	Order No.	Lead-free
4	92317-04XX	Yes
6	92317-06XX	
8	92317-08XX	
10	92317-10XX	
12	92317-12XX	
14	92317-14XX	

Circuits	Order No.	Lead-free
16	92317-16XX	Yes
18	92317-18XX	
20	92317-20XX	
22	92317-22XX	
24	92317-24XX	
26	92317-26XX	

Length	XX
6-99cm	06-99
100cm	01
105cm	02
110cm	03
115cm	04
120cm	05

Replace XX with length in cm (min. 6cm, max. 120cm), see table
Example: 92317-0832 is a cable with two 90327-0308, 32cm long

1.27mm (.050") Pitch Picoflex™ PF-50 Custom Cable Harness

92318

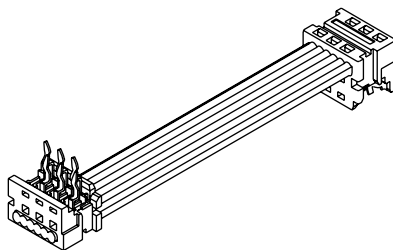

Features and Benefits

- Cable assembly with 90327 and 90584 connectors, Z-style
- Sizes 4 to 26
- UL 2651, 28 AWG (7 strand) ribbon cable
- Lengths from 6 to 120cm

Reference Information

Packaging: Tube
Mates With: 90325, 90800, 90814, 90715 and 90779
Designed In: Millimeters

Electrical

Voltage: 250V
Current: 1.2A

Mechanical

Mating Force: 1.7N
Unmating Force: 0.25N
Durability: 30 cycles max.

Physical

Housing: 6/6 nylon, UL 94V-0
Contact: Phosphor Bronze Alloy
Plating: 3 to 6µ" Tin
Insulation: Cable—Gray PVC
Wire Range: 28 AWG

Circuits	Order No.	Lead-free
4	92318-04XX	Yes
6	92318-06XX	
8	92318-08XX	
10	92318-10XX	
12	92318-12XX	
14	92318-14XX	

Circuits	Order No.	Lead-free
16	92318-16XX	Yes
18	92318-18XX	
20	92318-20XX	
22	92318-22XX	
24	92318-24XX	
26	92318-26XX	

Length	XX
6-99cm	06-99
100cm	01
105cm	02
110cm	03
115cm	04
120cm	05

Replace XX with length in cm (min. 6cm, max. 120cm), see table
Example: 92318-0832 is a cable with 90327-0308 and 90584-2308, 32cm long

1.27mm (.050") Pitch Picoflex™ PF-50 Custom Cable Harness

92316

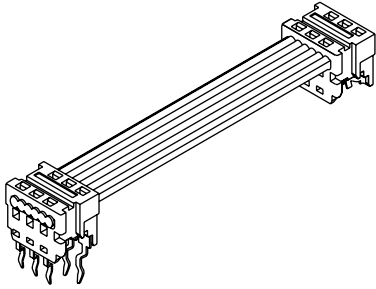

Features and Benefits

- Cable assembly with 90327 and 90584 connectors, C-style
- Sizes 4 to 26
- UL 2651, 28 AWG (7 strand) ribbon cable
- Lengths from 6 to 120cm

Reference Information

Packaging: Tube
Mates With: 90325, 90800, 90814, 90715 and 90779
Designed In: Millimeters

Electrical

Voltage: 250V
Current: 1.2A

Mechanical

Mating Force: 1.7N
Unmating Force: 0.25N
Durability: 30 cycles max.

Physical

Housing: 6/6 nylon, UL 94V-0
Contact: Phosphor Bronze Alloy
Plating: 3 to 6µ" Tin
Insulation: Cable—Gray PVC
Wire Range: 28 AWG

Circuits	Order No.	Lead-free
4	92316-04XX	Yes
6	92316-06XX	
8	92316-08XX	
10	92316-10XX	
12	92316-12XX	
14	92316-14XX	

Circuits	Order No.	Lead-free
16	92316-16XX	Yes
18	92316-18XX	
20	92316-20XX	
22	92316-22XX	
24	92316-24XX	
26	92316-26XX	

Length	XX
6-99cm	06-99
100cm	01
105cm	02
110cm	03
115cm	04
120cm	05

Replace XX with length in cm (min. 6 cm, max. 120cm), see table
Example: 92316-0832 is a cable with 90327-0308 and 90584-2308, 32cm long

2.54mm (.100") Pitch QF-50™ Connector System For 1.27mm (.050") Pitch Ribbon Cable

Molex offers one of the widest ranges of connectors for 1.27mm (.050") ribbon cable on the market today. The QF-50 family features a variety of products conforming to industry-standard styles, such as DIN 41651, MIL-C-83503 keying, HE-10, etc. There is a choice of receptacle styles addressed to specific market requirements and a variety of designer-friendly headers.

Receptacles

Built to the highest-quality standards, 2 distinct styles are offered:

- 5320 series, incorporating a dual-contact beam independently acknowledged to out-perform others on the market
- 90635 series, a lower-cost single-contact beam product, offering all the technical performance of its dual-beam counterpart, while also offering MIL keying

Headers

Available in 3 styles:

- Latch-eject style uniquely functioning with or without strain reliefs on receptacles and with ejectors that remain flush with the body, thus saving valuable PCB real estate
- Standard shrouded headers
- Low-profile headers in industry-standard styles with various options, including variable board location/retention features and SMT-compatible insulators

Application Tooling

Molex has developed a choice of equipment that allows you to tailor your application tooling according to your volumes—from simple hand tools to high-volume automatic termination. Various packaging styles are available as options to optimize your applied cost. Please see end of section.

Cable

In line with the philosophy of offering our customers a complete interconnection solution, Molex also supplies the necessary cable to get you connected! Please refer to section H.

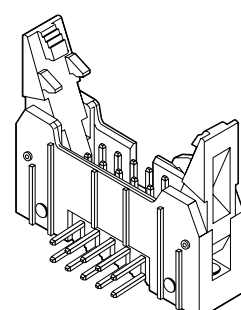
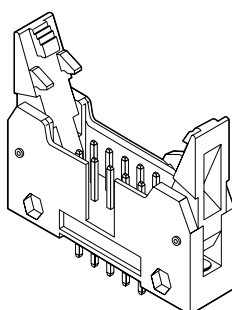
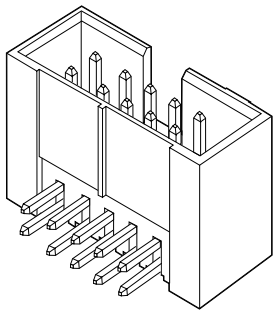
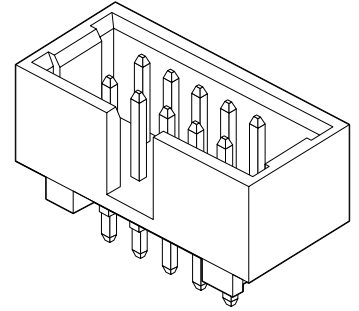
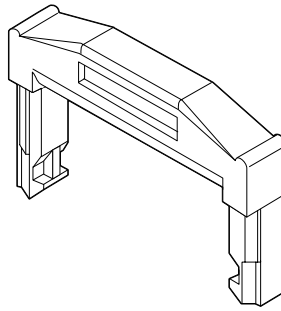
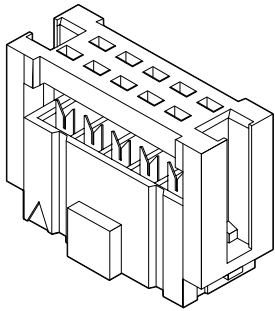

2.54mm (.100") Pitch QF-50™ Receptacle

5320-NA Dual Row Unloaded Upper Housing

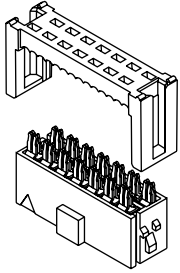

Features and Benefits

- Sizes 10 to 64 circuits
- For 1.27mm (.050") ribbon cable
- Single polarization

Reference Information

Packaging: Tray
 Tooling Information: See section U
 UL File No.: E29179
 CSA File No.: LR19980
 Mates With: 5330, 5332, 5340, 5342, 5576 and 5578
 Use With: 90170 strain relief
 Designed In: Millimeters

Electrical

Current: 1.0A
 Contact Resistance: 20 milliohms max.
 Dielectric Withstanding Voltage: 500V AC
 Insulation Resistance: 1000 Megohms min.

Physical

Housing: Black glass-filled polyester, UL 94V-0
 Contact: Phosphor Bronze Alloy
 Plating: See Table
 Cable Accommodation: 26 AWG stranded and 28 AWG stranded and solid
 Insulation Range: 1.14mm (.045") diameter max.

Circuits	Order No.		Lead-free
	4µ" (0.1µm) Gold	35µ" (0.9µm) Tin	
10	39-53-4106	39-52-1104	Yes
14	39-53-4146	39-52-1144	
16	39-53-4166	39-52-1164	
20	39-53-4206	39-52-1204	
26	39-53-4266	39-52-1264	
30	39-53-4306	39-52-1304	

Circuits	Order No.		Lead-free
	4µ" (0.1µm) Gold	35µ" (0.9µm) Tin	
34	39-53-4346	39-52-1344	Yes
40	39-53-4406	39-52-1404	
50	39-53-4506	39-52-1504	
60	39-53-4606		
64	39-53-4646		

2.54mm (.100) Pitch QF-50™ Receptacle

5320-NB Dual Row Preloaded Upper Housing

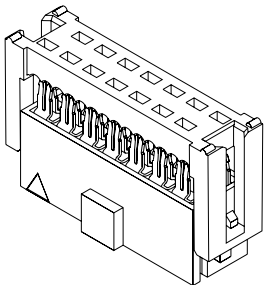

Features and Benefits

- Sizes 10 to 64 circuits
- For 1.27mm (.050") ribbon cable
- Single polarization

Reference Information

Packaging: Tray
 UL File No.: E29179
 CSA File No.: LR37272-P21
 Mates With: 5330, 5332, 5340, 5342, 5576 and 5578
 Use With: 90170 strain relief
 Designed In: Millimeters

Electrical

Current: 1.0A
 Contact Resistance: 20 milliohms max.
 Dielectric Withstanding Voltage: 500V AC
 Insulation Resistance: 1000 Megohms min.

Physical

Housing: Black glass-filled polyester, UL 94V-0
 Contact: Phosphor Bronze Alloy
 Plating: See Table
 Cable Accommodation: 26 AWG stranded and 28 AWG stranded and solid
 Insulation Range: 1.14mm (.045") diameter max.

Circuits	Order No.			Lead-free
	4µ" (0.1µm) Gold	30µ" (0.76µm) Gold	35µ" (0.9µm) Tin	
10	39-53-3109	39-53-4100	39-52-1105	Yes
14	39-53-3149	39-53-4140	39-52-1145	
16	39-53-3169	39-53-4160	39-52-1165	
20	39-53-3209	39-53-4200	39-52-1205	
26	39-53-3269	39-53-4260	39-52-1265	
30	39-53-3309	39-53-4300	39-52-1305	

Circuits	Order No.			Lead-free
	4µ" (0.1µm) Gold	30µ" (0.76µm) Gold	35µ" (0.9µm) Tin	
34	39-53-3349	39-53-4340	39-52-1345	Yes
40	39-53-3409	39-53-4400	39-52-1405	
50	39-53-3509	39-53-4500	39-52-1505	
60	39-53-3609	39-53-4600		
64	39-53-3649	39-53-4640		

1.27mm (.050") Pitch QF-50™ Receptacle

90635
Vertical, MIL/DIN Version

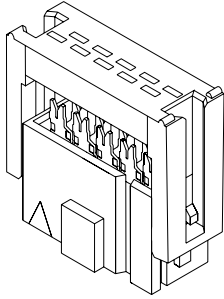

Features and Benefits

- Sizes 10 to 64 circuits
- Available with or without polarization
- Complies with industry-standard DIN 41651 and MIL-3-83503 keying
- Selective Gold plating option for contacts
- Available in various packaging styles

Reference Information

Product Specification: PS-99020-0015
Packaging: Tray (contact Molex for chain)
Tooling Information: See end of section
Mates With: 90663
Use With: 90170 strain relief
Designed In: Millimeters

Electrical

Voltage: 250V
Current: 1.0A
Contact Resistance: 20 milliohms max.
Dielectric Withstanding Voltage: 500V AC
Insulation Resistance: 1000 Megohms min.

Mechanical

Mating Force: 350g (0.77 lb) max. per circuit
Unmating Force: 50g (0.11 lb) min. per circuit
Durability: 300 cycles max.

Physical

Housing: Glass-filled polyester, UL 94V-0
Contact: Copper Alloy
Plating: See Table
Cable Accommodation: 26 AWG stranded and 28 AWG stranded and solid

Circuits	Order No.						Lead-free
	With Polarization			Without Polarization			
	Plating 1	Plating 2	Plating 3	Plating 1	Plating 2	Plating 3	
10	90635-1101	90635-1102	90635-1103	90635-3101	90635-3102	90635-3103	Yes
14	90635-1141	90635-1142	90635-1143	90635-3141	90635-3142	90635-3143	
16	90635-1161	90635-1162	90635-1163	90635-3161	90635-3162	90635-3163	
20	90635-1201	90635-1202	90635-1203	90635-3201	90635-3202	90635-3203	
24	90635-1241	90635-1242	90635-1243	90635-3241	90635-3242	90635-3243	
26	90635-1261	90635-1262	90635-1263	90635-3261	90635-3262	90635-3263	
30	90635-1301	90635-1302	90635-1303	90635-3301	90635-3302	90635-3303	
34	90635-1341	90635-1342	90635-1343	90635-3341	90635-3342	90635-3343	
40	90635-1401	90635-1402	90635-1403	90635-3401	90635-3402	90635-3403	
50	90635-1501	90635-1502	90635-1503	90635-3501	90635-3502	90635-3503	
60	90635-1601	90635-1602	90635-1603	90635-3601	90635-3602	90635-3603	
64	90635-1641	90635-1642	90635-1643	90635-3641	90635-3642	90635-3643	

Plating 1: Contact area: 4µ" Gold flash min. IDT area: 39µ" min. Tin over Nickel.
Plating 2: Contact area: 30µ" Gold min. IDT area: 39µ" min. Tin over Nickel.
Plating 3: Contact area: 15µ" Gold min. IDT area: 39µ" Tin over Nickel.

QF-50™ Strain Relief

90170
DIN 41651, Standard
Low Profile

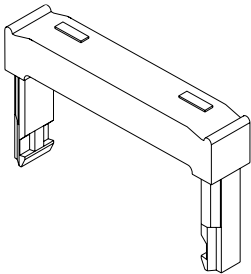

Features and Benefits

- Complies with industry-standard DIN 41651

Reference Information

Product Specification: PS-99020-0015
Packaging: Bag
Use With: 5320 and 90635
Designed In: Inches

Physical

Housing: Black glass-filled polyester, UL 94V-0

Preferred Version in Europe

Circuits*	Order No.
10	90170-0010
14	90170-0014
16	90170-0016
20	90170-0020
26	90170-0026
30	90170-0030

Circuits*	Order No.
34	90170-0034
40	90170-0040
50	90170-0050
60	90170-0060
64	90170-0064

* Number of circuits on mating connector

2.54mm (.100") Pitch QF-50™ Shrouded Header 5332 Vertical, Dual Row Single Polarization

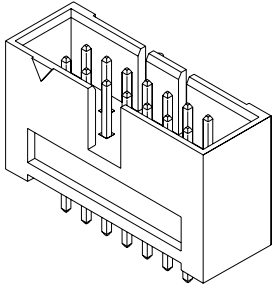

Features and Benefits

- Sizes 10 to 60 circuits
- Selective Gold- and Tin-plated versions

Reference Information

Packaging: Tray
UL File No.: E29179-E
Mates With: 5320-NA and 5320-NB
Designed In: Millimeters

Electrical

Current: 1.0A
Contact Resistance: 20 milliohms max.
Dielectric Withstanding Voltage: 500V AC
Insulation Resistance: 1000 Megohms min.

Physical

Housing: Black glass-filled polyester, UL 94V-0
Contact: Brass
Contact Pin: 0.635mm (.025") square
Plating: See Table

Circuits	Order No.			Lead-free
	4μ" (0.1μm) Gold	30μ" (0.76μm) Gold	35μ" (0.9μm) Tin	
10	39-53-6104	39-53-6105	39-28-5101	Yes
14	39-53-6144	39-53-6145	39-28-5141	
16	39-53-6164	39-53-6165	39-28-5161	
20	39-53-6204	39-53-6205	39-28-5201	
26	39-53-6264	39-53-6265	39-28-5261	

Circuits	Order No.			Lead-free
	4μ" (0.1μm) Gold	30μ" (0.76μm) Gold	35μ" (0.9μm) Tin	
30	39-53-6304	39-53-6305	39-28-5301	Yes
34	39-53-6344	39-53-6345	39-28-5341	
40	39-53-6404	39-53-6405		
50	39-53-6504	39-53-6505		
60	39-53-6604	39-53-6605		

2.54mm (.100") Pitch QF-50™ Shrouded Header 5342 Right Angle, Dual Row Single Polarization

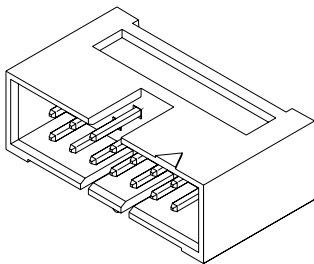

Features and Benefits

- Sizes 10 to 60 circuits
- Selective Gold- and Tin-plated versions

Reference Information

Packaging: Tray
UL File No.: E29179-E
Mates With: 5320-NA and 5320-NB
Designed In: Millimeters

Electrical

Current: 1.0A
Contact Resistance: 20 milliohms max.
Dielectric Withstanding Voltage: 500V AC
Insulation Resistance: 1000 Megohms min.

Physical

Housing: Black glass-filled polyester, UL 94V-0
Contact: Brass
Contact Pin: 0.635mm (.025") square
Plating: See Table

Circuits	Order No.			Lead-free
	4μ" (0.1μm) Gold	30μ" (0.76μm) Gold	35μ" (0.9μm) Tin	
10	39-53-7104	39-53-7105	39-28-5104	Yes
14	39-53-7144	39-53-7145	39-28-5144	
16	39-53-7164	39-53-7165	39-28-5164	
20	39-53-7204	39-53-7205	39-28-5204	
26	39-53-7264	39-53-7265	39-28-5264	

Circuits	Order No.			Lead-free
	4μ" (0.1μm) Gold	30μ" (0.76μm) Gold	35μ" (0.9μm) Tin	
30	39-53-7304	39-53-7305	39-28-5304	Yes
34	39-53-7344	39-53-7345	39-28-5344	
40	39-53-7404	39-53-7405		
50	39-53-7504	39-53-7505		
60	39-53-7604	39-53-7605		

2.54mm (.100") Pitch QF-50™ Shrouded Header

5330
Vertical, Dual Row
With Eject Levers

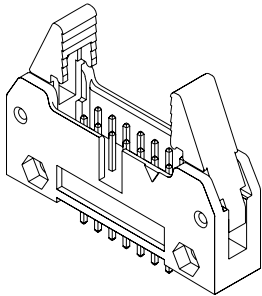

Features and Benefits

- Sizes 10 to 64 circuits
- Polarized
- Stackable side-by-side
- Latches connector with or without strain relief
- Selective Gold- and overall Tin-plated versions
- Lever spring pins—Stainless Steel

Reference Information

Packaging: Tray
UL File No.: E29179-E
CSA File No.: LR19980
Mates With: 5320-NA and 5320-NB
Designed In: Millimeters

Electrical

Current: 1.0A
Contact Resistance: 20 milliohms max.
Dielectric Withstanding Voltage: 500V AC
Insulation Resistance: 1000 Megohms min.

Physical

Housing: Black glass-filled polyester, UL 94V-0
Contact: Brass
Contact Pins: 0.635mm (.025") square
Plating: See Table

Circuits	Order No.			Lead-free
	4μ" (0.1μm) Gold	30μ" (0.76μm) Gold	35μ" (0.9μm) Tin	
10	39-35-2106	39-53-5109	39-28-5100	Yes
14	39-35-2146	39-53-5149	39-28-5140	
16	39-35-2166	39-53-5169	39-28-5160	
20	39-35-2206	39-53-5209	39-28-5200	
26	39-35-2266	39-53-5269	39-28-5260	
30	39-35-2306	39-53-5309	39-28-5300	

Circuits	Order No.			Lead-free
	4μ" (0.1μm) Gold	30μ" (0.76μm) Gold	35μ" (0.9μm) Tin	
34	39-35-2346	39-53-5349	39-28-5340	Yes
40	39-35-2406	39-53-5409	39-28-5400	
50	39-35-2506	39-53-5509	39-28-5500	
60	39-35-2606	39-53-5609		
64	39-35-2646	39-53-5649		

2.54mm (.100") Pitch QF-50™ Shrouded Header

5340
Right Angle, Dual Row
With Eject Levers

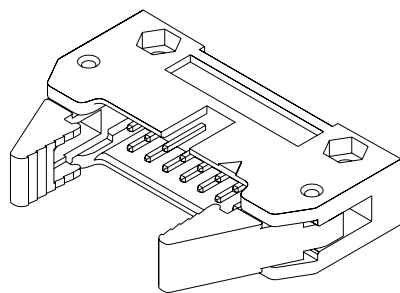

Features and Benefits

- Sizes 10 to 64 circuits
- Polarized
- Stackable side-by-side
- Selective Gold- and overall Tin-plated versions
- Lever spring pins—Stainless Steel

Reference

Packaging: Tray
UL File No.: E29179-E
Mates With: 5320-NA and 5320-NB
Designed In: Millimeters

Electrical

Current: 1.0A
Contact Resistance: 20 milliohms max.
Dielectric Withstanding Voltage: 500V AC
Insulation Resistance: 1000 Megohms min.

Physical

Housing: Black glass-filled polyester, UL 94V-0
Contact: Brass
Contact Pin: 0.635mm (.025") square
Plating: See Table

Circuits	Order No.			Lead-free
	4μ" (0.1μm) Gold	30μ" (0.76μm) Gold	35μ" (0.9μm) Tin	
10	39-53-3107	39-53-7108	39-28-5103	Yes
14	39-53-3147	39-53-7148	39-28-5143	
16	39-53-3167	39-53-7168	39-28-5163	
20	39-53-3207	39-53-7208	39-28-5203	
26	39-53-3267	39-53-7268	39-28-5263	
30	39-53-3307	39-53-7308	39-28-5303	

Circuits	Order No.			Lead-free
	4μ" (0.1μm) Gold	30μ" (0.76μm) Gold	35μ" (0.9μm) Tin	
34	39-53-3347	39-53-7348	39-28-5343	Yes
40	39-53-3407	39-53-7408	39-28-5403	
50	39-53-3507	39-53-7508	39-28-5503	
60	39-53-3607	39-53-7608		
64	39-53-3647	39-53-7648		

2.54mm (.100") Pitch QF-50™ Shrouded Header

5576 Vertical With Eject Levers

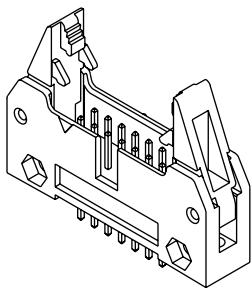

Features and Benefits

- 10 to 64 circuits
- Tin plated on solder tail
- Complies with industry standard DIN 41654
- Polarized
- Selective Gold plating options for contacts
- Eject levers allow end-to-end stacking with or without strain relief with no loss of board space

Reference Information

Packaging: Tray
Designed In: Millimeters
Mates With: 5320

Electrical

Voltage: 250V
Current: 1.0A
Contact Resistance: 20 milliohms max.
Dielectric Withstanding Voltage: 500V
Insulation Resistance: 1000 Megohms min.

Physical

Housing: Glass-filled PBTP
Contact: Brass

Circuits	Order No.			Lead-free
	Plating NBGS1	Plating NBGS2	Plating NBT2	
10	39-27-1103	39-27-1104	39-28-5105	Yes
14	39-27-1143	39-27-1144	39-28-5145	
16	39-27-1163	39-27-1164	39-28-5165	
20	39-27-1203	39-27-1204	39-28-5205	
26	39-27-1263	39-27-1264	39-28-5265	
30	39-27-1303	39-27-1304	39-28-5305	

Plating NBGS1: 39µm (1.5µm) min. Nickel underplate. Contact area: 0.1µm min. Gold.
Solder area: 3µm min. Tin

Plating NBGS2: 39µm (1.5µm) min. Nickel underplate. Contact area: 0.76µm min. Gold.
Solder area: 3µm min. Tin

Plating NBT2: 20µm (0.5µm) min. Nickel underplate. Contact and solder area: 39µm (1.5µm) min. Tin

Circuits	Order No.			Lead-free
	Plating NBGS1	Plating NBGS2	Plating NBT2	
34	39-27-1343	39-27-1344	39-28-5345	Yes
40	39-27-1403	39-27-1404	39-28-5405	
50	39-27-1503	39-27-1504	39-28-5505	
60	39-27-1603	39-27-1604		
64	39-27-1643	39-27-1644		

2.54mm (.100") Pitch QF-50™ Shrouded Header

5578 Right Angle With Eject Levers

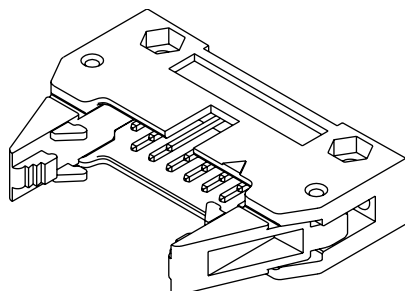

Features and Benefits

- 10 to 64 circuits
- Tin plated on solder tail
- Complies with industry standard DIN 41654
- Polarized
- Selective Gold plating options for contacts
- Eject levers allow end-to-end stacking with or without strain relief with no loss of board space

Reference Information

Packaging: Tray
Mates With: 5320
Designed In: Millimeters

Electrical

Voltage: 250V
Current: 1.0A
Contact Resistance: 20 milliohms max.
Dielectric Withstanding Voltage: 500V
Insulation Resistance: 1000 Megohms min.

Physical

Housing: Glass-filled PBTP
Contact: Brass

Circuits	Order No.			Lead-free
	Plating NBGS17F	Plating NBGS2	Plating NBT2	
10	39-53-6108	39-53-6109	39-28-5106	Yes
14	39-53-6148	39-53-6149	39-28-5146	
16	39-53-6168	39-53-6169	39-28-5166	
20	39-53-6208	39-53-6209	39-28-5206	
26	39-53-6268	39-53-6269	39-28-5266	
30	39-53-6308	39-53-6309	39-28-5306	

Plating NBGS1: 39µm (1.5µm) min. Nickel underplate. Contact area: 0.1µm min. Gold.
Solder area: 3µm min. Tin

Plating NBGS2: 39µm (1.5µm) min. Nickel underplate. Contact area: 0.76µm min. Gold.
Solder area: 3µm min. Tin

Plating NBT2: 20µm (0.5µm) min. Nickel underplate. Contact and solder area: 39µm (1.5µm) min. Tin

Circuits	Order No.			Lead-free
	Plating NBGS17F	Plating NBGS2	Plating NBT2	
34	39-53-6348	39-53-6349	39-28-5346	Yes
40	39-53-6408	39-53-6409	39-28-5406	
50	39-53-6508	39-53-6509	39-28-5506	
60	39-53-6608	39-53-6609		
64	39-53-6648	39-53-6649		

2.54mm (.100") Pitch QF-50™ Shrouded Header

90663
Vertical, MIL Keying
With Latch/Eject Levers

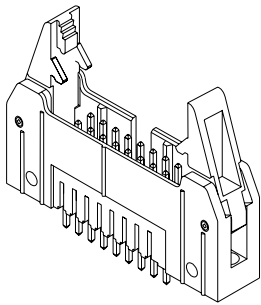

Features and Benefits

- Sizes 10 to 64 circuits
- Tin plated on solder tail
- Complies with industry-standard DIN 41651 and MIL-3-83503 keying
- Selective Gold plating options for contacts
- Eject levers allow end-to-end stacking with or without strain relief with no loss of board space
- Polarized
- Contact Molex for variations on eject levers

Reference Information

Product Specification: PS-99020-0015
Packaging: Tray
Mates With: 90635
Designed In: Millimeters

Electrical

Voltage: 250V
Current: 2.5A
Contact Resistance: 20 milliohms max.
Dielectric Withstanding Voltage: 500V AC
Insulation Resistance: 1000 Megohms min.

Mechanical

Pin Retention Force: 1.5kg (3.3 lb)
Mating Force: 350g (0.77 lb) max. per circuit
Unmating Force: 50g (0.11 lb) min. per circuit
Durability: 300 cycles max.

Physical

Housing: Black glass-filled polyester, UL 94V-0
Contact: Copper Alloy
Plating: See Table

Circuits	Order No.			Lead-free
	Plating 1	Plating 2	Plating 3	
10	90663-1101	90663-1102	90663-1103	Yes
14	90663-1141	90663-1142	90663-1143	
16	90663-1161	90663-1162	90663-1163	
20	90663-1201	90663-1202	90663-1203	
26	90663-1261	90663-1262	90663-1263	
30	90663-1301	90663-1302	90663-1303	

Note: Also available with 91081 ejectors. Please contact Molex.

Plating 1: 4µm Gold in contact area, 118µm Tin in solder area, 39µm Nickel underplate
Plating 2: 30µm Gold in contact area, 118µm Tin in solder area, 39µm Nickel underplate
Plating 3: 10µm Gold in contact area, 118µm Tin in solder area, 39µm Nickel underplate

Circuits	Order No.			Lead-free
	Plating 1	Plating 2	Plating 3	
34	90663-1341	90663-1342	90663-1343	Yes
40	90663-1401	90663-1402	90663-1403	
50	90663-1501	90663-1502	90663-1503	
60	90663-1601	90663-1602	90663-1603	
64	90663-1641	90663-1642	90663-1643	

2.54mm (.100") Pitch QF-50™ Shrouded Header

90663
Right Angle, MIL Keying
With Latch/Eject Levers

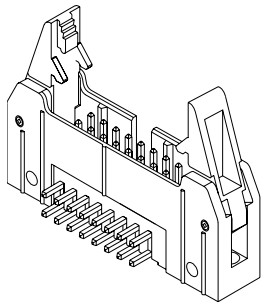

Features and Benefits

- Sizes 10 to 64 circuits
- Tin plated on solder tail
- Complies with industry-standard DIN 41651 and MIL-3 83503 keying
- Selective Gold plating options for contacts
- Eject levers allow end-to-end stacking with or without strain relief with no loss of board space
- Polarized
- Contact Molex for variations on eject levers

Reference Information

Product Specification: PS-99020-0015
Packaging: Tray
Mates With: 90635
Designed In: Millimeters

Electrical

Voltage: 250V
Current: 2.5A
Contact Resistance: 20 milliohms max.
Dielectric Withstanding Voltage: 500V AC
Insulation Resistance: 1000 Megohms min.

Mechanical

Pin Retention Force: 1.5kg (3.3 lb)
Mating Force: 350g (0.77 lb) max. per circuit
Unmating Force: 50g (0.11 lb) min. per circuit
Durability: 300 cycles max.

Physical

Housing: Black glass-filled polyester, UL 94V-0
Contact: Copper Alloy
Plating: See Table

Circuits	Order No.			Lead-free
	Plating 1	Plating 2	Plating 3	
10	90663-3101	90663-3102	90663-3103	Yes
14	90663-3141	90663-3142	90663-3143	
16	90663-3161	90663-3162	90663-3163	
20	90663-3201	90663-3202	90663-3203	
26	90663-3261	90663-3262	90663-3263	
30	90663-3301	90663-3302	90663-3303	

Plating 1: 4µm Gold in contact area, 118µm Tin in solder area, 39µm Nickel underplate
Plating 2: 30µm Gold in contact area, 118µm Tin in solder area, 39µm Nickel underplate
Plating 3: 10µm Gold in contact area, 118µm Tin in solder area, 39µm Nickel underplate

Circuits	Order No.			Lead-free
	Plating 1	Plating 2	Plating 3	
34	90663-3341	90663-3342	90663-3343	Yes
40	90663-3401	90663-3402	90663-3403	
50	90663-3501	90663-3502	90663-3503	
60	90663-3601	90663-3602	90663-3603	
64	90663-3641	90663-3642	90663-3643	

2.54mm (.100") Pitch SL™ Ribbon Cable Connectors

70400/70475 Single Row Cable Connector System

Please refer to section A of this catalog for more detailed information

Features and Benefits

- Sizes 2 to 25 circuits
- Modular connectors for use with SL single row shrouded headers and clips
- Terminals preloaded into housings
- Polarization and positive locking options

Reference Information

Packaging: Tube
 UL File No.: E29179
 CSA File No.: LR19980
 Use Molex Cable: 7307, 7767, 8996, 8997, 24226, 24241, 24369 and 24389
 Designed In: Inches

Electrical

Voltage: 250V
 Current: 3.0A max
 Contact Resistance: 15 milliohms max.
 Dielectric Withstanding Voltage: 1500V
 Insulation Resistance: 10,000 Megohms min.

Mechanical

Contact Insertion Force: 3.11N (0.7 lb) max.
 Contact Retention to Housing: 17.79N (4 lb) min.
 for 15 seconds
 Durability: Tin—25 cycles; Gold—50 cycles

Physical

Housing: Polyester, UL 94V-0
 Contact: Copper alloy

Version D — Male

70475

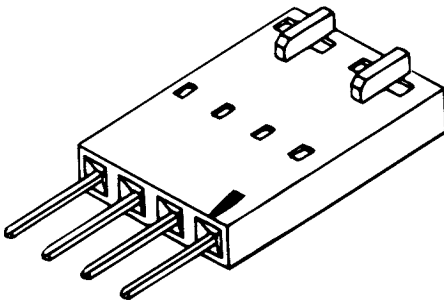

Version A — Female

70400

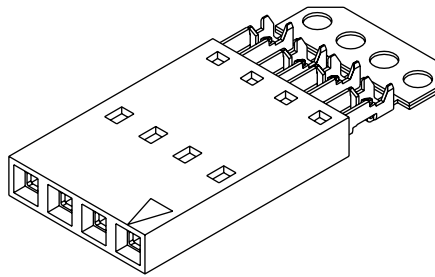

Version C — Female

70400

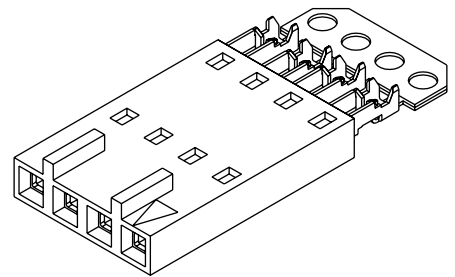

Version D — Female

70400

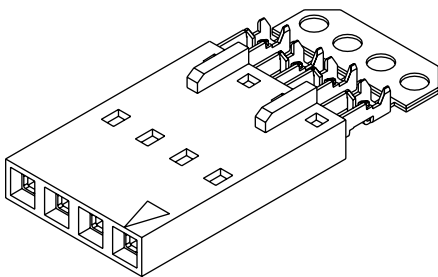

Version G — Female

70400

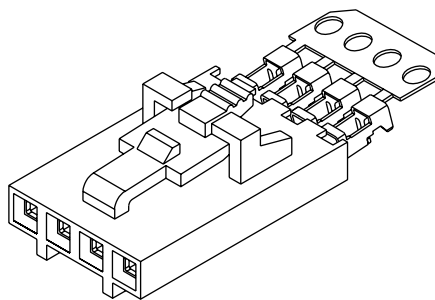

2.00mm (.079") Pitch Wire Trap

52147 Pull-Cover Style Vertical

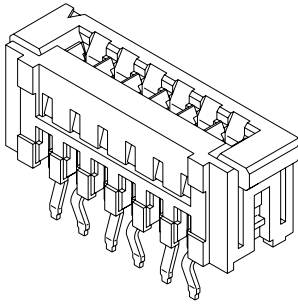

Features and Benefits

- Sizes 2 to 17 circuits
- For topcoated ribbon cable
- Wire range: 26 AWG
- Insulation diameter: 1.60mm max.
- Strip length: 4.50mm

Reference Information

Product Specification: PS-52147-001
Packaging: Tray
UL File No.: E29179
Designed In: Millimeters

Electrical

Voltage: 150V max.
Current: 2.0A max.
Contact Resistance: 20 milliohms max.
Dielectric Withstanding Voltage: 500V AC/1 min.
Insulation Resistance: 1000 Megohms min.

Physical

Housing: Glass-filled PBT, UL 94V-0
Actuator: Glass-filled PBT, UL 94V-0
Contact: Phosphor Bronze
Plating: Tin

Circuits	Order No.	Lead-free
2	52147-0210	Yes
3	52147-0310	
4	52147-0410	
5	52147-0510	
6	52147-0610	
7	52147-0710	
8	52147-0810	
9	52147-0910	

Circuits	Order No.	Lead-free
10	52147-1010	Yes
11	52147-1110	
12	52147-1210	
13	52147-1310	
14	52147-1410	
15	52147-1510	
16	52147-1610	
17	52147-1710	

Note: All PC tails kinked opposite ways except two-circuit version, which has no kinks

2.00mm (.079") Pitch Wire Trap

52151 Pull-Cover Style Right Angle

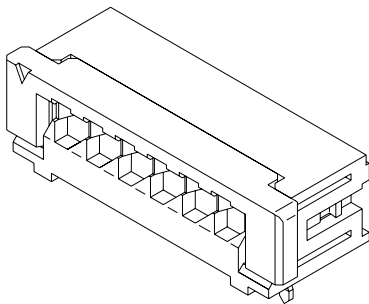

Features and Benefits

- Sizes 2 to 16 circuits
- For topcoated ribbon cable
- Wire range: 26 AWG
- Insulation diameter: 1.60mm max.
- Strip length: 4.50mm

Reference Information

Product Specification: PS-52147-001
Packaging: Tray
UL File No.: E29179
Designed In: Millimeters

Electrical

Voltage: 150V max.
Current: 2.0A max.
Contact Resistance: 20 milliohms max.
Dielectric Withstanding Voltage: 500V AC/1 min.
Insulation Resistance: 1000 Megohms min.

Physical

Housing: Glass-filled PBT, UL 94V-0
Actuator: Glass-filled PBT, UL 94V-0
Contact: Phosphor Bronze
Plating: Tin

Circuits	Order No.	Lead-free
2	52151-0210	Yes
3	52151-0310	
4	52151-0410	
5	52151-0510	
6	52151-0610	
7	52151-0710	
8	52151-0810	
9	52151-0910	

Circuits	Order No.	Lead-free
10	52151-1010	Yes
11	52151-1110	
12	52151-1210	
13	52151-1310	
14	52151-1410	
15	52151-1510	
16	52151-1610	

Note: All PC tails kinked opposite ways except two-circuit version, which has no kinks

www.molex.com/industry/automotive.html

www.molex.com

molex[®]
one company › a world of innovation