

Xinger®

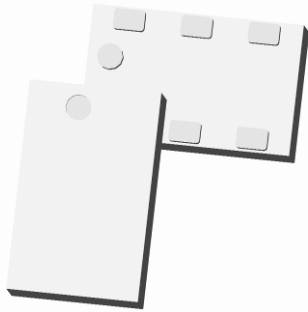

Ultra Low Profile 0805 20dB Directional Coupler

Description

The DC4759J5020AHF is a low cost, low profile sub-miniature high performance 20 dB directional coupler in an easy to use RoHS compliant, Halogen Free surface mount package. It is designed for 4700 – 5900MHz applications including: WiFi and P2P / P2MP applications. The DC4759J5020AHF is ideal for power detection, signal injection and other applications where low insertion loss signal monitoring is required. The DC4759J5020AHF is available on tape and reel for pick and place high volume manufacturing. All of the Xinger components are constructed from ceramic filled PTFE composites which possess excellent electrical and mechanical stability. All parts have been subjected to rigorous qualification testing and units are 100% RF tested.

Detailed Electrical Specifications: Specifications subject to change without notice.

Features:	ROOM (25°C)												
	Frequency (MHz)	Mean Coupling (dB)			Insertion loss (dB)		Return Loss (dB)		Directivity (dB)		Frequency Sensitivity (dB)		Power Handling @85°C (watts)
		Min	Typ.	Max	Typ.	Max	Typ.	Min	Typ.	Min	Typ.	Max	
<ul style="list-style-type: none"> • 4700 – 5900 MHz • Mean Coupling 20dB • 0.58mm Height Profile • Ultra Low Insertion Loss • Surface Mountable • Tape & Reel • RoHS Compliant • Halogen Free • -55°C to 140°C 	4900-5500	18.3	19.4	20.6	0.14	0.27	8.3	6.9	15.4	11.0	0.19	0.21	2
	4700-5900	18.6	19.7	21.0	0.17	0.32	7.6	6.3	10.3	5.3	0.91	1.02	2

**Specification based on performance of unit properly installed on microstrip printed circuit boards with 50 Ω nominal impedance.

Outline Drawing

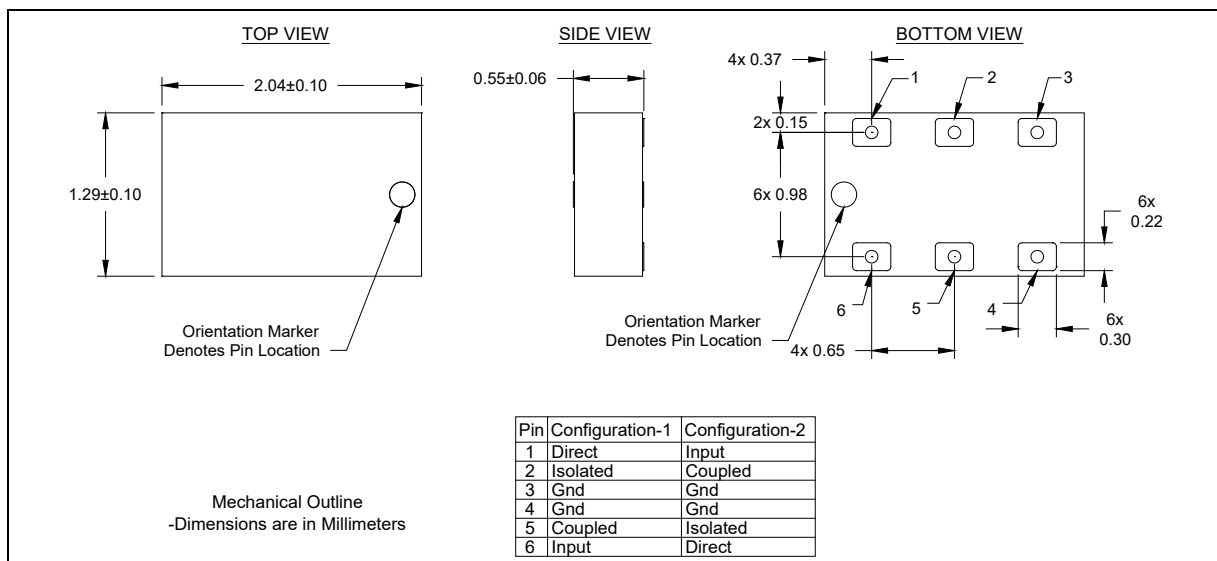

Typical Performance: 4700 MHz. to 5900 MHz. (Configuration 1)

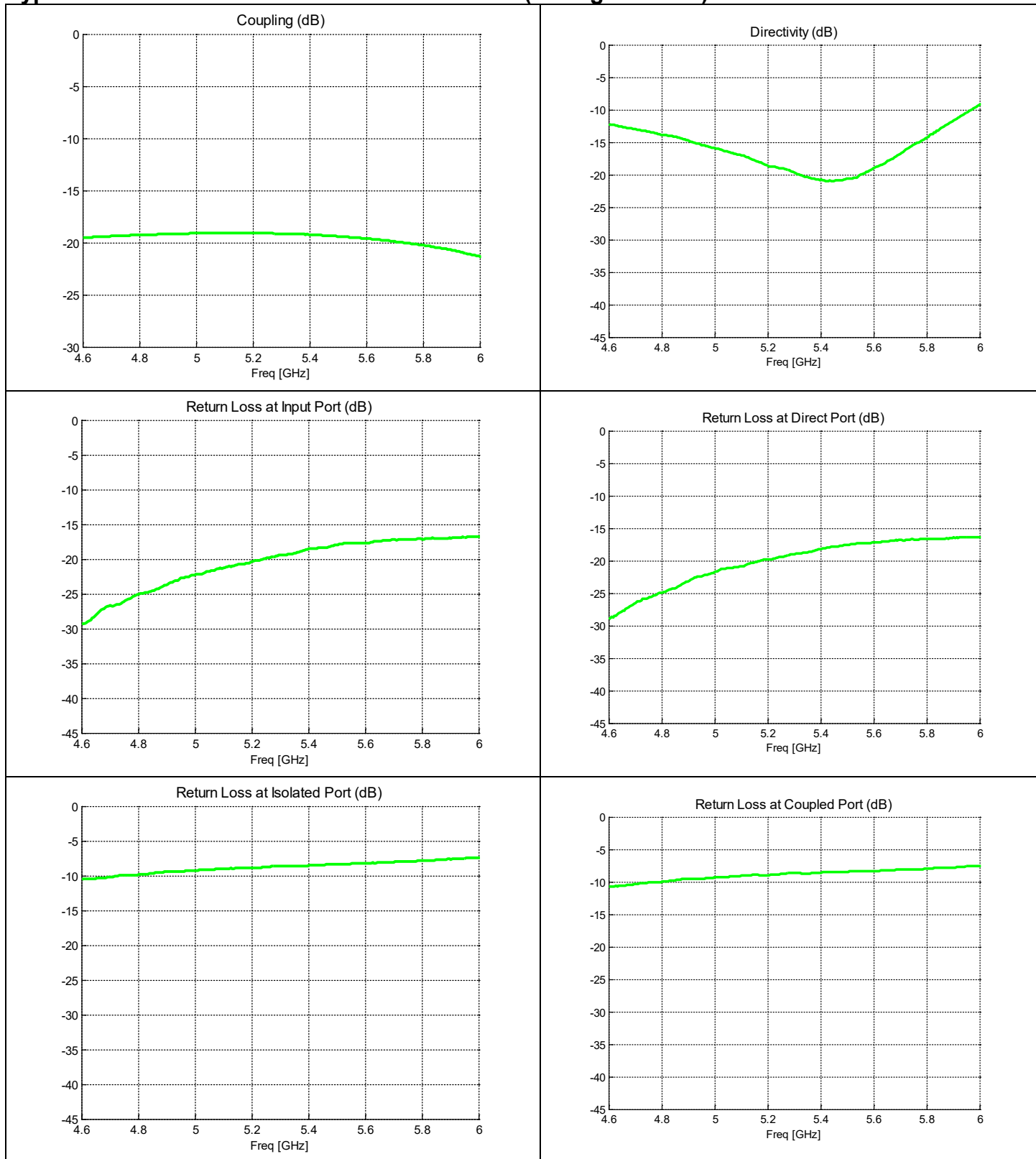

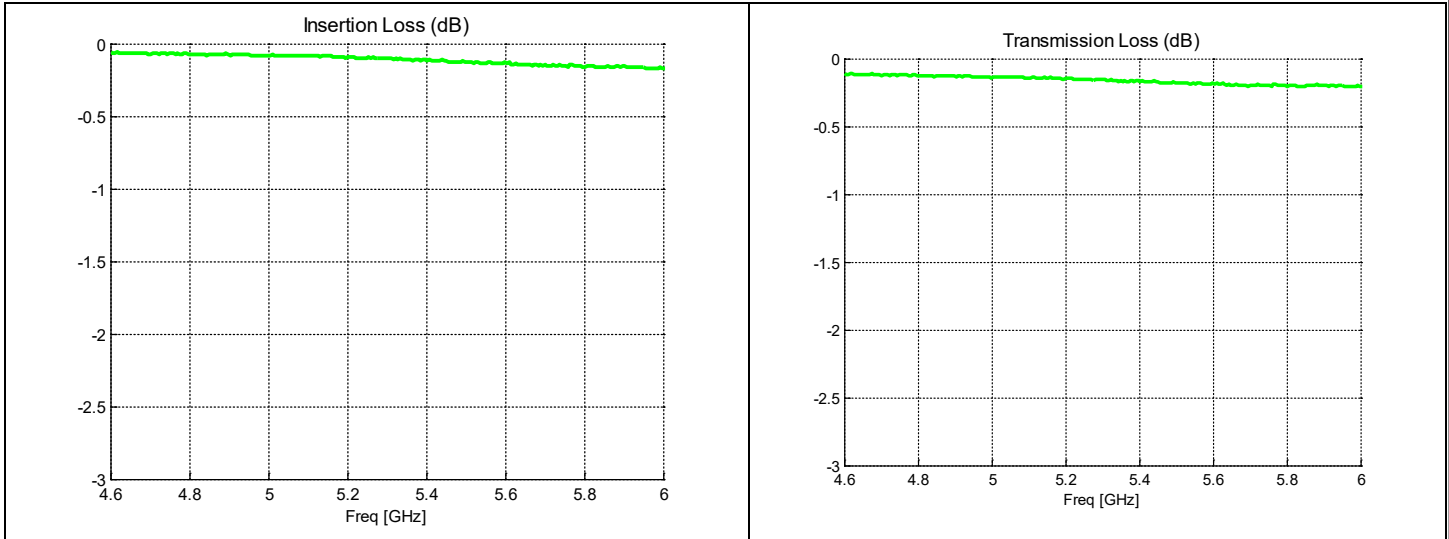

Wideband Performance: 0 to 8500MHz (Configuration 1)

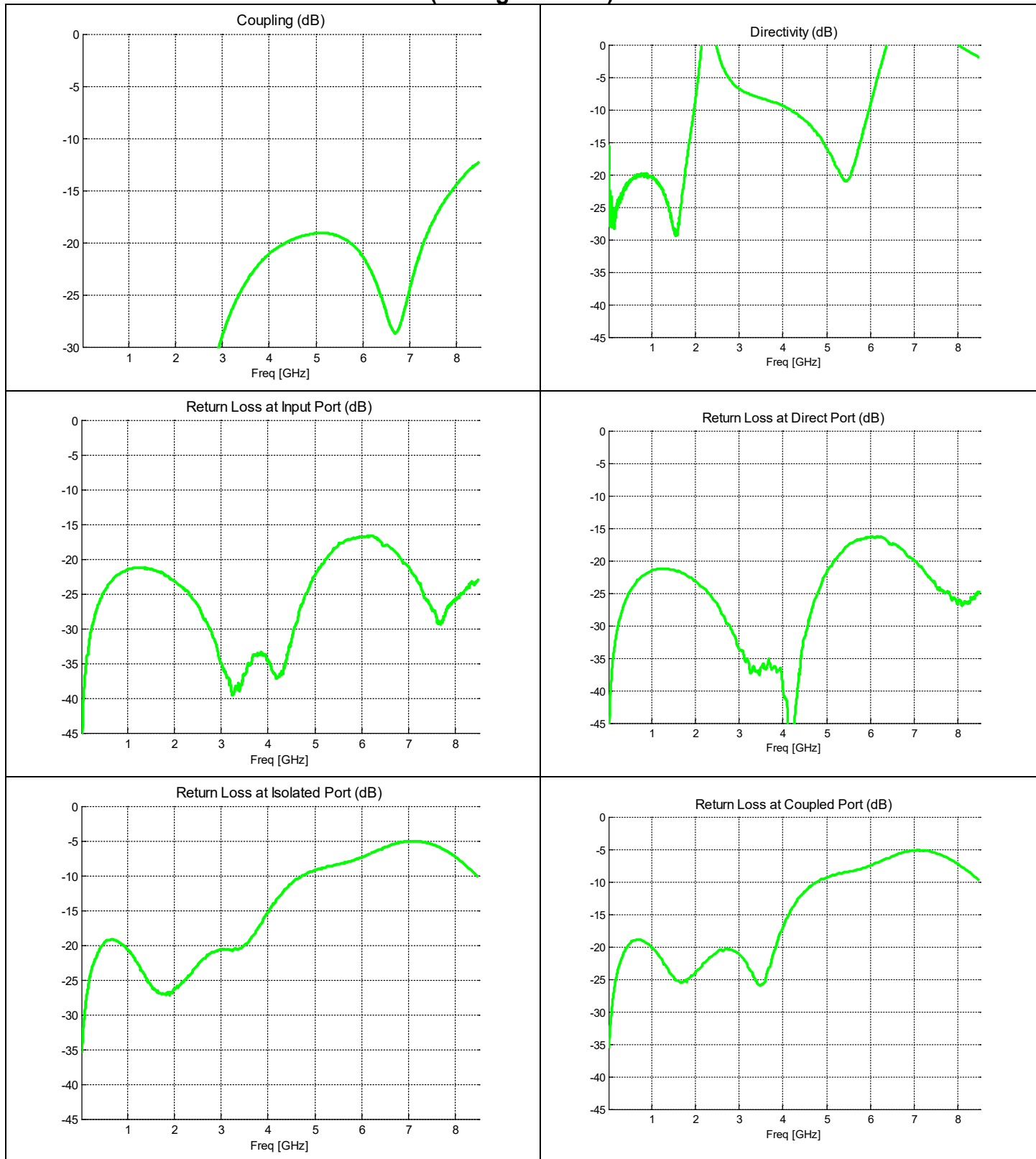

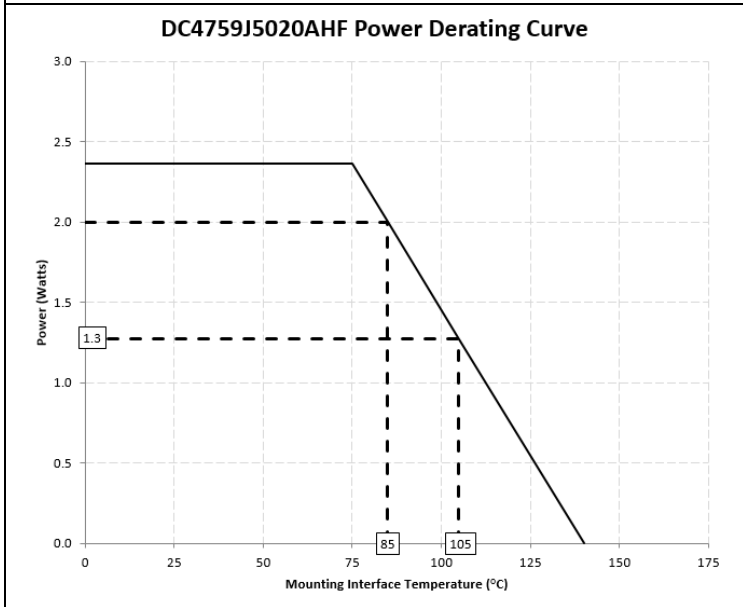
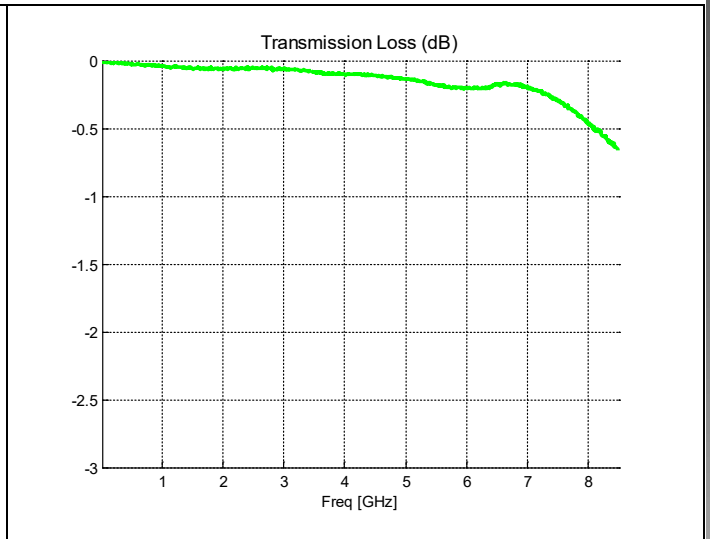
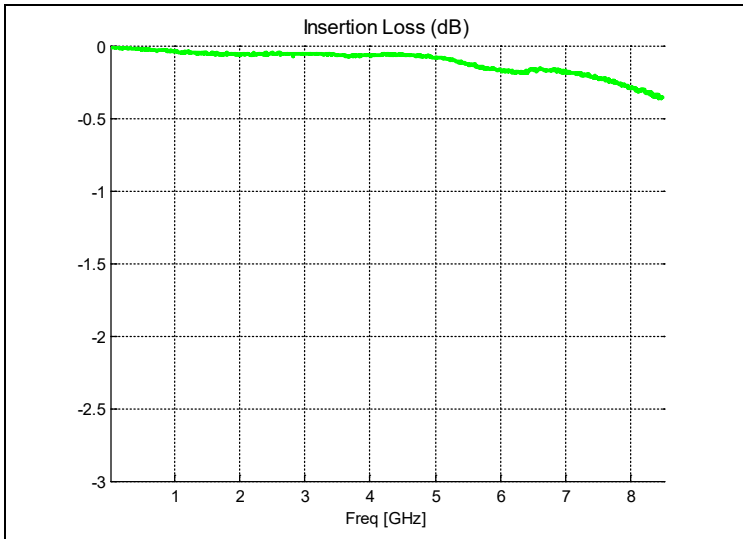

Definition of Measured Specifications

Parameter	Definition	Mathematical Representation for Pin Configuration 1	Mathematical Representation for Pin Configuration 2
Return Loss	The impedance match of the coupler to a 50Ω system. Return Loss is an alternate means to express VSWR.	Return Loss (dB)= $20 \log_{10}(S_{ii}) \quad i = 1, 2, 3, 4$	Return Loss (dB)= $20 \log_{10}(S_{ii}) \quad i = 1, 2, 3, 4$
Mean Coupling	At a given frequency (ω_n), coupling is the input power divided by the power at the coupled port. Mean coupling is the average value of the coupling values in the band. N is the number of frequencies in the band.	Coupling (dB) = $C = 20 \log_{10} S_{34} $ Mean Coupling (dB) = $\frac{\sum_{n=1}^N C(\omega_n)}{N}$	Coupling (dB) = $C = 20 \log_{10} S_{21} $ Mean Coupling (dB) = $\frac{\sum_{n=1}^N C(\omega_n)}{N}$
Insertion Loss	The input power divided by the sum of the power at the two output ports.	$10 \log_{10} (S_{14} ^2 + S_{34} ^2)$	$10 \log_{10} (S_{41} ^2 + S_{21} ^2)$
Transmission Loss	The input power divided by the power at the direct port.	$20 \log_{10} (S_{14})$	$20 \log_{10} (S_{41})$
Directivity	The power at the coupled port divided by the power at the isolated port.	$20 \log_{10} \left(\frac{ S_{24} }{ S_{34} } \right)$	$20 \log_{10} \left(\frac{ S_{31} }{ S_{21} } \right)$
Frequency Sensitivity	The decibel difference between the maximum in band coupling value and the minimum in band coupling value.	(Max Coupling (dB) – Min Coupling (dB))/2	(Max Coupling (dB) – Min Coupling (dB))/2

*100% RF test is performed on configuration 1 where port 1 is connected to pin1, port 2 is connected to pin 2, port 3 is connected to pin 5 and port 4 is connected to pin 6.

Mounting Configuration:

In order for Xinger surface mount components to work optimally, the proper impedance transmission lines must be used to connect to the RF ports. If this condition is not satisfied, insertion loss, Isolation and VSWR may not meet published specifications.

All of the Xinger components are constructed from organic PTFE based composites which possess excellent electrical and mechanical stability. Xinger components are compliant to a variety of ROHS and Green standards and ready for Pb-free soldering processes. Pads are Gold plated with a Nickel barrier.

An example of the PCB footprint used in the testing of these parts is shown below. In specific designs, the transmission line widths need to be adjusted to the unique dielectric coefficients and thicknesses as well as varying pick and place equipment tolerances.

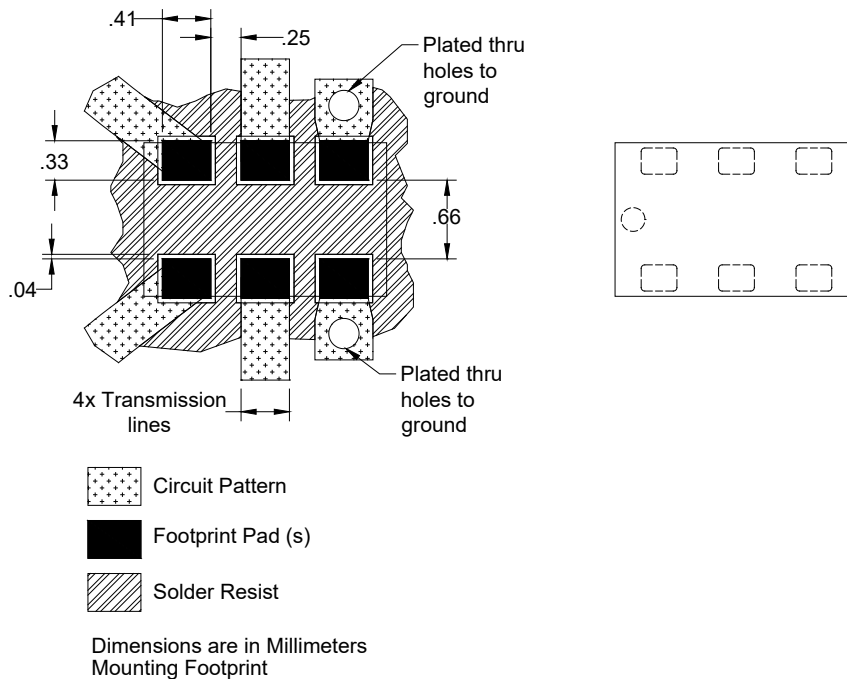

Packaging and Ordering Information

Parts are available in reel and are packaged per EIA 481-D. Parts are oriented in tape and reel as shown below. Minimum order quantities are 4000 per reel.

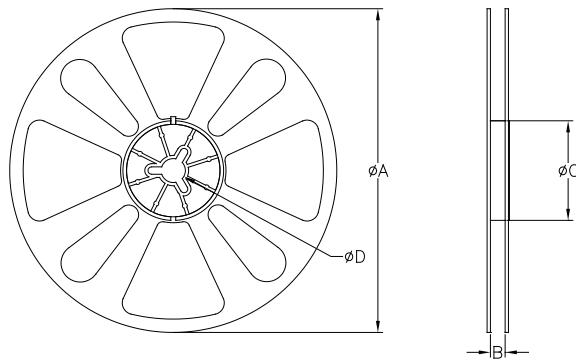
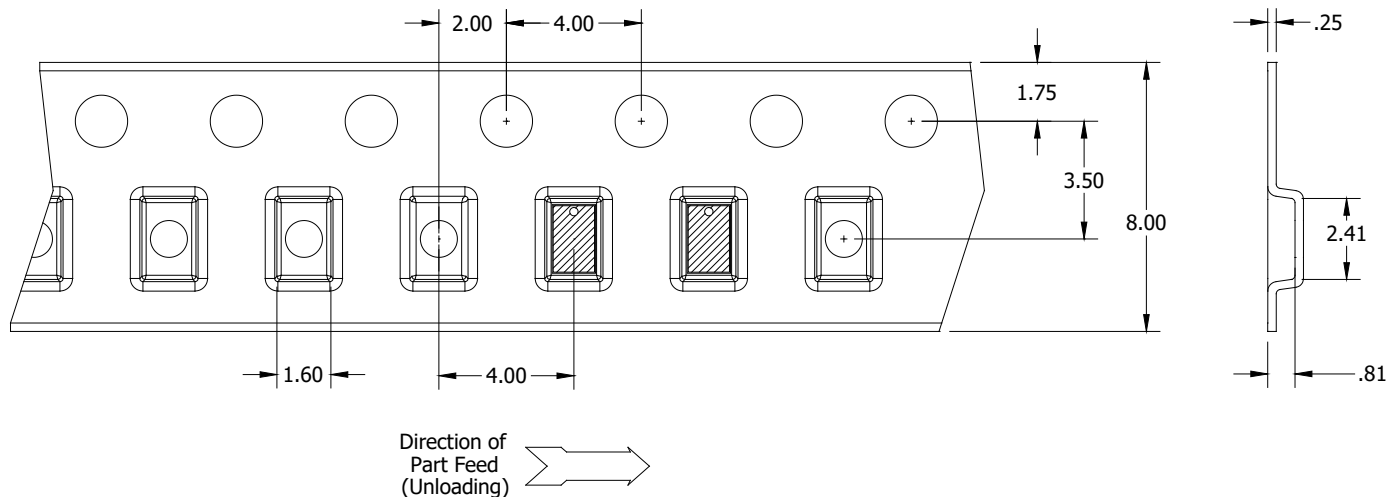

QUANTITY/REEL	REEL DIMENSIONS mm	
4000	ϕA	177.80
	B	8.00
	ϕC	50.80
	ϕD	13.00