

## FEATURES

Output frequency range: 400 MHz to 6 GHz  
 1 dB output compression:  $\geq 9.0$  dBm from 450 MHz to 4 GHz  
 Output return loss  $\leq -12$  dB from 450 MHz to 4.5 GHz  
 Noise floor:  $-160$  dBm/Hz @ 900 MHz  
 Sideband suppression:  $\leq -50$  dBc @ 900 MHz  
 Carrier feedthrough:  $\leq -45$  dBm @ 900 MHz  
 IQ3dB bandwidth:  $\geq 750$  MHz  
 Baseband input bias level  
   **ADL5375-EP**: 500 mV  
 Single supply: 4.75 V to 5.25 V  
 24-lead LFCSP\_WQ package

## ENHANCED PRODUCT FEATURES

Supports defense and aerospace applications (AQEC)  
 Extended temperature range  $-55^{\circ}\text{C}$  to  $+105^{\circ}\text{C}$   
 Controlled manufacturing baseline  
 One assembly/test site  
 One fabrication site  
 Enhanced product change notification  
 Qualification data available on request

## APPLICATIONS

Cellular communication systems  
   GSM/EDGE, CDMA2000, W-CDMA, TD-SCDMA  
 WiMAX/LTE broadband wireless access systems  
 Satellite modems  
 Defense and aerospace systems

## GENERAL DESCRIPTION

The **ADL5375-EP** is a broadband quadrature modulator designed for operation from 400 MHz to 6 GHz. Its excellent phase accuracy and amplitude balance enable high performance intermediate frequency or direct radio frequency modulation for communication systems.

The **ADL5375-EP** features a broad baseband bandwidth, along with an output gain flatness that varies no more than 1 dB from 450 MHz to 5 GHz. These features, coupled with a broadband output return loss of  $\leq -12$  dB, make the **ADL5375-EP** ideally suited for broadband zero IF or low IF-to-RF applications, broadband digital predistortion transmitters, and multiband radio designs.

## FUNCTIONAL BLOCK DIAGRAM

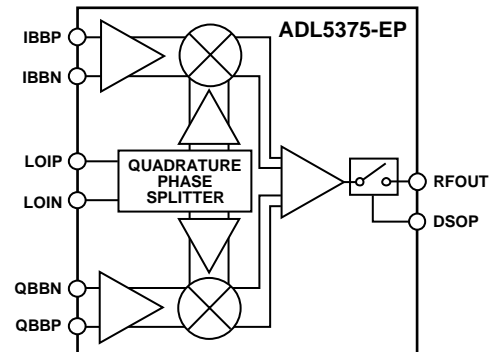

Figure 1.

10275-001

The **ADL5375-EP** accepts two differential baseband inputs and a single-ended LO. It generates a single-ended 50  $\Omega$  output. The **ADL5375-EP** offers an input baseband bias level of 500 mV.

The **ADL5375-EP** is fabricated using an advanced silicon-germanium bipolar process. It is available in a 24-lead, exposed paddle, lead-free, LFCSP\_WQ package. Performance is specified over a  $-55^{\circ}\text{C}$  to  $+105^{\circ}\text{C}$  temperature range. A lead-free evaluation board is also available.

Additional application and technical information can be found in the **ADL5375** data sheet.

Rev. A

[Document Feedback](#)

Information furnished by Analog Devices is believed to be accurate and reliable. However, no responsibility is assumed by Analog Devices for its use, nor for any infringements of patents or other rights of third parties that may result from its use. Specifications subject to change without notice. No license is granted by implication or otherwise under any patent or patent rights of Analog Devices. Trademarks and registered trademarks are the property of their respective owners.

One Technology Way, P.O. Box 9106, Norwood, MA 02062-9106, U.S.A.  
 Tel: 781.329.4700 ©2011–2014 Analog Devices, Inc. All rights reserved.  
[Technical Support](#) [www.analog.com](http://www.analog.com)

**TABLE OF CONTENTS**

Features .....	1	Absolute Maximum Ratings .....	6
Enhanced Product Features .....	1	ESD Caution.....	6
Applications.....	1	Pin Configuration and Function Descriptions.....	7
Functional Block Diagram .....	1	Typical Performance Characteristics .....	8
General Description .....	1	Outline Dimensions.....	13
Revision History .....	2	Ordering Guide .....	13
Specifications.....	3		

**REVISION HISTORY**

**6/14—Rev. 0 to Rev. A**

Changes to Figure 13 and Figure 14.....	9
Changes to Figure 15, Figure 17, and Figure 20 .....	10
Changes to Figure 21 and Figure 22.....	11
Changes to Ordering Guide.....	13

**11/11—Revision 0: Initial Version**

## SPECIFICATIONS

$V_S = 5\text{ V}$ ;  $T_A = 25^\circ\text{C}$ ; LO = 0 dBm single-ended drive; baseband I/Q amplitude = 1 V p-p differential sine waves in quadrature with a 500 mV dc bias; baseband I/Q frequency ( $f_{\text{BB}}$ ) = 1 MHz, unless otherwise noted.

Table 1.

Parameter	Test Conditions/Comments	Min	Typ	Max	Unit
OPERATING FREQUENCY RANGE					
Low frequency			400		MHz
High frequency			6000		MHz
LO = 450 MHz					
Output Power, $P_{\text{OUT}}$	$V_{\text{IQ}} = 1\text{ V p-p differential}$		0.85		dBm
Modulator Voltage Gain	RF output divided by baseband input voltage		-3.1		dB
Output P1dB			9.6		dBm
Output Return Loss			-16.4		dB
Carrier Feedthrough			-47.5		dBm
Sideband Suppression			-37.6		dBc
Quadrature Error			1.7		Degrees
I/Q Amplitude Balance			0.07		dB
Second Harmonic	$P_{\text{OUT}} - (f_{\text{LO}} + (2 \times f_{\text{BB}}))$ , $P_{\text{OUT}} = 0.85\text{ dBm}$		-75.9		dBc
Third Harmonic	$P_{\text{OUT}} - (f_{\text{LO}} + (3 \times f_{\text{BB}}))$ , $P_{\text{OUT}} = 0.85\text{ dBm}$		-51.5		dBc
Output IP2	$f_{1\text{BB}} = 3.5\text{ MHz}$ , $f_{2\text{BB}} = 4.5\text{ MHz}$ , baseband I/Q amplitude per tone = 0.5 V p-p differential		65.4		dBm
Output IP3	$f_{1\text{BB}} = 3.5\text{ MHz}$ , $f_{2\text{BB}} = 4.5\text{ MHz}$ , baseband I/Q amplitude per tone = 0.5 V p-p differential		26.6		dBm
Noise Floor	I/Q inputs = 0 V differential with a dc bias only, 20 MHz carrier offset		-160.5		dBm/Hz
LO = 900 MHz					
Output Power, $P_{\text{OUT}}$	$V_{\text{IQ}} = 1\text{ V p-p differential}$		0.75		dBm
Modulator Voltage Gain	RF output divided by baseband input voltage		-3.2		dB
Output P1dB			9.6		dBm
Output Return Loss			-15.7		dB
Carrier Feedthrough			-45.1		dBm
Sideband Suppression			-52.8		dBc
Quadrature Error			0.01		Degrees
I/Q Amplitude Balance			0.07		dB
Second Harmonic	$P_{\text{OUT}} - (f_{\text{LO}} + (2 \times f_{\text{BB}}))$ , $P_{\text{OUT}} = 0.75\text{ dBm}$		-75.8		dBc
Third Harmonic	$P_{\text{OUT}} - (f_{\text{LO}} + (3 \times f_{\text{BB}}))$ , $P_{\text{OUT}} = 0.75\text{ dBm}$		-50.7		dBc
Output IP2	$f_{1\text{BB}} = 3.5\text{ MHz}$ , $f_{2\text{BB}} = 4.5\text{ MHz}$ , baseband I/Q amplitude per tone = 0.5 V p-p differential		62.6		dBm
Output IP3	$f_{1\text{BB}} = 3.5\text{ MHz}$ , $f_{2\text{BB}} = 4.5\text{ MHz}$ , baseband I/Q amplitude per tone = 0.5 V p-p differential		25.9		dBm
Noise Floor	I/Q inputs = 0 V differential with a dc bias only, 20 MHz carrier offset		-160.0		dBm/Hz
LO = 1900 MHz					
Output Power, $P_{\text{OUT}}$	$V_{\text{IQ}} = 1\text{ V p-p differential}$		0.53		dBm
Modulator Voltage Gain	RF output divided by baseband input voltage		-3.4		dB
Output P1dB			9.9		dBm
Output Return Loss			-16.2		dB
Carrier Feedthrough			-40.3		dBm
Sideband Suppression			-50.2		dBc
Quadrature Error			0.02		Degrees
I/Q Amplitude Balance			0.07		dB
Second Harmonic	$P_{\text{OUT}} - (f_{\text{LO}} + (2 \times f_{\text{BB}}))$ , $P_{\text{OUT}} = 0.53\text{ dBm}$		-67.9		dBc
Third Harmonic	$P_{\text{OUT}} - (f_{\text{LO}} + (3 \times f_{\text{BB}}))$ , $P_{\text{OUT}} = 0.53\text{ dBm}$		-51.8		dBc

Parameter	Test Conditions/Comments	Min	Typ	Max	Unit
Output IP2	f1BB = 3.5 MHz, f2BB = 4.5 MHz, baseband I/Q amplitude per tone = 0.5 V p-p differential		62.6		dBm
Output IP3	f1BB = 3.5 MHz, f2BB = 4.5 MHz, baseband I/Q amplitude per tone = 0.5 V p-p differential		24.3		dBm
Noise Floor	I/Q inputs = 0 V differential with a dc bias only, 20 MHz carrier offset		-160.0		dBm/Hz
LO = 2150 MHz					
Output Power, P <sub>OUT</sub>	V <sub>IQ</sub> = 1 V p-p differential		0.73		dBm
Modulator Voltage Gain	RF output divided by baseband input voltage		-3.2		dB
Output P1dB			10.0		dBm
Output Return Loss			-17.1		dB
Carrier Feedthrough			-39.7		dBm
Sideband Suppression			-47.3		dBc
Quadrature Error			-0.16		Degrees
I/Q Amplitude Balance			0.07		dB
Second Harmonic	P <sub>OUT</sub> - (f <sub>LO</sub> + (2 × f <sub>BB</sub> )), P <sub>OUT</sub> = 0.73 dBm		-71.3		dBc
Third Harmonic	P <sub>OUT</sub> - (f <sub>LO</sub> + (3 × f <sub>BB</sub> )), P <sub>OUT</sub> = 0.73 dBm		-52.4		dBc
Output IP2	f1BB = 3.5 MHz, f2BB = 4.5 MHz, baseband I/Q amplitude per tone = 0.5 V p-p differential		61.6		dBm
Output IP3	f1BB = 3.5 MHz, f2BB = 4.5 MHz, baseband I/Q amplitude per tone = 0.5 V p-p differential		24.2		dBm
Noise Floor	I/Q inputs = 0 V differential with a dc bias only, 20 MHz carrier offset		-159.5		dBm/Hz
LO = 2600 MHz					
Output Power, P <sub>OUT</sub>	V <sub>IQ</sub> = 1 V p-p differential		0.61		dBm
Modulator Voltage Gain	RF output divided by baseband input voltage		-3.4		dB
Output P1dB			9.6		dBm
Output Return Loss			-19.3		dB
Carrier Feedthrough			-36.5		dBm
Sideband Suppression			-48.3		dBc
Quadrature Error			-0.37		Degrees
I/Q Amplitude Balance			0.07		dB
Second Harmonic	P <sub>OUT</sub> - (f <sub>LO</sub> + (2 × f <sub>BB</sub> )), P <sub>OUT</sub> = 0.61 dBm		-60.9		dBc
Third Harmonic	P <sub>OUT</sub> - (f <sub>LO</sub> + (3 × f <sub>BB</sub> )), P <sub>OUT</sub> = 0.61 dBm		-51.3		dBc
Output IP2	f1BB = 3.5 MHz, f2BB = 4.5 MHz, baseband I/Q amplitude per tone = 0.5 V p-p differential		55.0		dBm
Output IP3	f1BB = 3.5 MHz, f2BB = 4.5 MHz, baseband I/Q amplitude per tone = 0.5 V p-p differential		22.7		dBm
Noise Floor	I/Q inputs = 0 V differential with a dc bias only, 20 MHz carrier offset		-159.0		dBm/Hz
LO = 3500 MHz					
Output Power, P <sub>OUT</sub>	V <sub>IQ</sub> = 1 V p-p differential		0.21		dBm
Modulator Voltage Gain	RF output divided by baseband input voltage		-3.8		dB
Output P1dB			9.6		dBm
Output Return Loss			-20.7		dB
Carrier Feedthrough			-30.4		dBm
Sideband Suppression			-48.3		dBc
Quadrature Error			0.01		Degrees
I/Q Amplitude Balance			0.08		dB
Second Harmonic	P <sub>OUT</sub> - (f <sub>LO</sub> + (2 × f <sub>BB</sub> )), P <sub>OUT</sub> = 0.21 dBm		-55.8		dBc
Third Harmonic	P <sub>OUT</sub> - (f <sub>LO</sub> + (3 × f <sub>BB</sub> )), P <sub>OUT</sub> = 0.21 dBm		-50.2		dBc
Output IP2	f1BB = 3.5 MHz, f2BB = 4.5 MHz, baseband I/Q amplitude per tone = 0.5 V p-p differential		51.1		dBm
Output IP3	f1BB = 3.5 MHz, f2BB = 4.5 MHz, baseband I/Q amplitude per tone = 0.5 V p-p differential		23.1		dBm
Noise Floor	I/Q inputs = 0 V differential with a dc bias only, 20 MHz carrier offset		-157.6		dBm/Hz

Parameter	Test Conditions/Comments	Min	Typ	Max	Unit
LO = 5800 MHz					
Output Power, P <sub>OUT</sub>	V <sub>IQ</sub> = 1 V p-p differential		-1.36		dBm
Modulator Voltage Gain	RF output divided by baseband input voltage		-5.3		dB
Output P1dB			4.9		dBm
Output Return Loss			-7.4		dB
Carrier Feedthrough			-19.5		dBm
Sideband Suppression			-38.2		dBc
Quadrature Error			-0.51		Degrees
I/Q Amplitude Balance			-0.05		dB
Second Harmonic	P <sub>OUT</sub> - (f <sub>LO</sub> + (2 × f <sub>BB</sub> )), P <sub>OUT</sub> = -1.36 dBm		-52.6		dBc
Third Harmonic	P <sub>OUT</sub> - (f <sub>LO</sub> + (3 × f <sub>BB</sub> )), P <sub>OUT</sub> = -1.36 dBm		-45.7		dBc
Output IP2	f1BB = 3.5 MHz, f2BB = 4.5 MHz, baseband I/Q amplitude per tone = 0.5 V p-p differential		39.1		dBm
Output IP3	f1BB = 3.5 MHz, f2BB = 4.5 MHz, baseband I/Q amplitude per tone = 0.5 V p-p differential		14.6		dBm
Noise Floor	I/Q inputs = 0 V differential with a dc bias only, 20 MHz carrier offset		-153.0		dBm/Hz
LO INPUTS					
LO Drive Level	Characterization performed at typical level	-6	0	+6	dBm
Input Return Loss	500 MHz < f <sub>LO</sub> < 3.3 GHz, see Figure 8 for return loss vs. frequency		≤ -10		dB
BASEBAND INPUTS	Pin IBBP, Pin IBBN, Pin QBBP, Pin QBBN				
I/Q Input Bias Level <sup>1</sup>			500		mV
Absolute Voltage Level <sup>1</sup>	On Pin IBBP, Pin IBBN, Pin QBBP, Pin QBBN	0		1	V
Input Bias Current	Current sourcing from each baseband input		41		μA
Input Offset Current			0.1		μA
Differential Input Impedance			60		kΩ
Bandwidth (0.1 dB)	LO = 1900 MHz, baseband input = 500 mV p-p sine wave		95		MHz
OUTPUT DISABLE	Pin DSOP				
Off Isolation	P <sub>OUT</sub> (DSOP low) - P <sub>OUT</sub> (DSOP high) DSOP high, LO leakage, LO = 2150 MHz		84		dB
Turn-On Settling Time	DSOP high to low (90% of envelope)		-55		dBm
Turn-Off Settling Time	DSOP high to low (90% of envelope)		220		ns
DSOP High Level (Logic 1)	DSOP low to high (10% of envelope)		100		ns
DSOP Low Level (Logic 0)		2.0		0.8	V
POWER SUPPLIES	Pin VPS1 and Pin VPS2				
Voltage		4.75		5.25	V
Supply Current	DSOP = low		194		mA
	DSOP = high		126		mA

<sup>1</sup> The input bias level can vary as long as the voltages on the individual IBBP, IBBN, QBBP, and QBBN pins remain within the specified absolute voltage level.

## ABSOLUTE MAXIMUM RATINGS

Table 2.

Parameter	Rating
Supply Voltage, VPOS	5.5 V
IBBP, IBBN, QBBP, QBBN	0 V to 2 V
LOIP and LOIN	13 dBm
Internal Power Dissipation	1500 mW
$\theta_{JA}$ (Exposed Paddle Soldered Down) <sup>1</sup>	54°C/W
Maximum Junction Temperature	150°C
Operating Temperature Range	-55°C to +105°C
Storage Temperature Range	-65°C to +150°C

<sup>1</sup> Per JEDEC standard JESD 51-2.

Stresses above those listed under Absolute Maximum Ratings may cause permanent damage to the device. This is a stress rating only; functional operation of the device at these or any other conditions above those indicated in the operational section of this specification is not implied. Exposure to absolute maximum rating conditions for extended periods may affect device reliability.

### ESD CAUTION



**ESD (electrostatic discharge) sensitive device.** Charged devices and circuit boards can discharge without detection. Although this product features patented or proprietary protection circuitry, damage may occur on devices subjected to high energy ESD. Therefore, proper ESD precautions should be taken to avoid performance degradation or loss of functionality.

## PIN CONFIGURATION AND FUNCTION DESCRIPTIONS

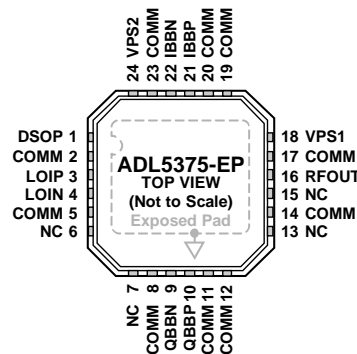

**NOTES**  
 1. NC = NO CONNECT. DO NOT CONNECT TO THIS PIN.  
 2. CONNECT EXPOSED PAD TO THE GROUND PLANE VIA A LOW IMPEDANCE PATH.

Figure 2. Pin Configuration

Table 3. Pin Function Descriptions

Pin No.	Mnemonic	Description
1	DSOP	Output Disable. A logic high on this pin disables the RF output. Connect this pin to ground or leave it floating to enable the output.
2, 5, 8, 11, 12, 14, 17, 19, 20, 23	COMM	Input Common Pins. Connect to the ground plane via a low impedance path.
3, 4	LOIP, LOIN	Local Oscillator Inputs. Single-ended operation: The LOIP pin is driven from the LO source through an ac-coupling capacitor while the LOIN pin is ac-coupled to ground through a capacitor. Differential operation: The LOIP and LOIN pins must be driven differentially through ac-coupling capacitors in this mode of operation.
6, 7, 13, 15, 9, 10, 21, 22	NC QBBN, QBBP, IBBN, IBBP	No Connect. These pins can be left open or tied to ground. Differential In-Phase and Quadrature Baseband Inputs. These high impedance inputs should be dc-biased to the recommended level (500 mV). These inputs should be driven from a low impedance source. Nominal characterized ac signal swing is 500 mV p-p on each pin. This results in a differential drive of 1 V p-p. These inputs are not self-biased and must be externally biased.
16	RFOUT	RF Output. Single-ended, 50 Ω internally biased RF output. RFOUT must be ac-coupled to the load.
18, 24	VPS1, VPS2	Positive Supply Voltage Pins. All pins should be connected to the same supply (V <sub>s</sub> ). To ensure adequate external bypassing, connect 0.1 μF and 100 pF capacitors between each pin and ground.
	EP	Exposed Pad. Connect to the ground plane via a low impedance path.

TYPICAL PERFORMANCE CHARACTERISTICS

$V_S = 5\text{ V}$ ;  $T_A = 25^\circ\text{C}$ ; LO = 0 dBm single-ended drive; baseband I/Q amplitude = 1 V p-p differential sine waves in quadrature with a 500 mV dc bias; baseband I/Q frequency ( $f_{BB}$ ) = 1 MHz, unless otherwise noted.

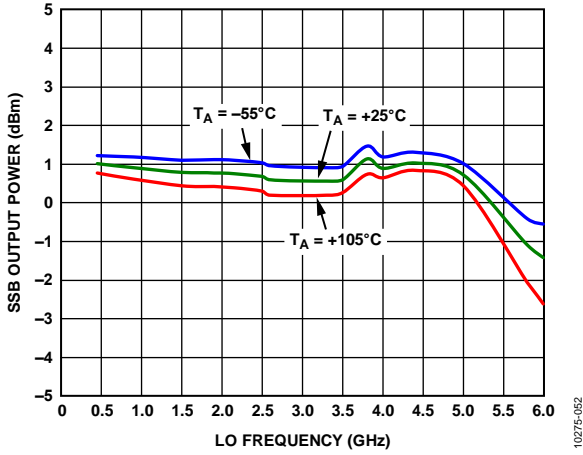

Figure 3. Single-Sideband (SSB) Output Power ( $P_{out}$ ) vs. LO Frequency ( $f_{LO}$ ) and Temperature

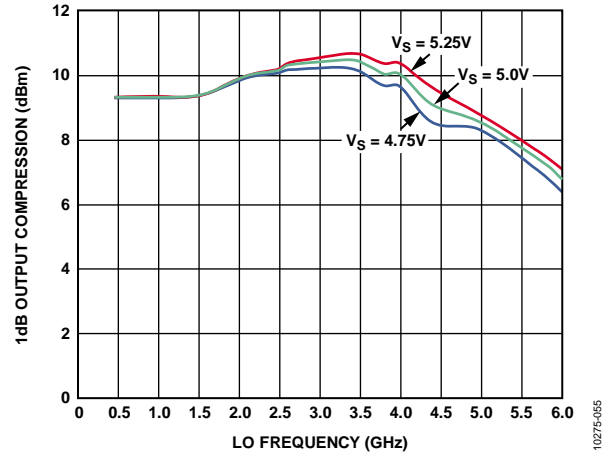

Figure 6. SSB Output 1dB Compression Point ( $OP_{1dB}$ ) vs. LO Frequency ( $f_{LO}$ ) and Supply

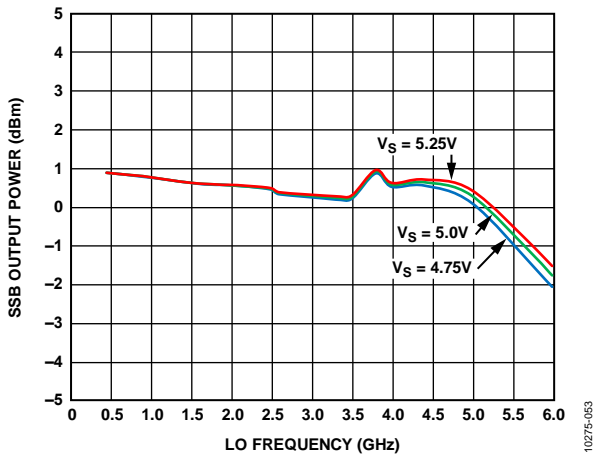

Figure 4. Single-Sideband (SSB) Output Power ( $P_{out}$ ) vs. LO Frequency ( $f_{LO}$ ) and Supply

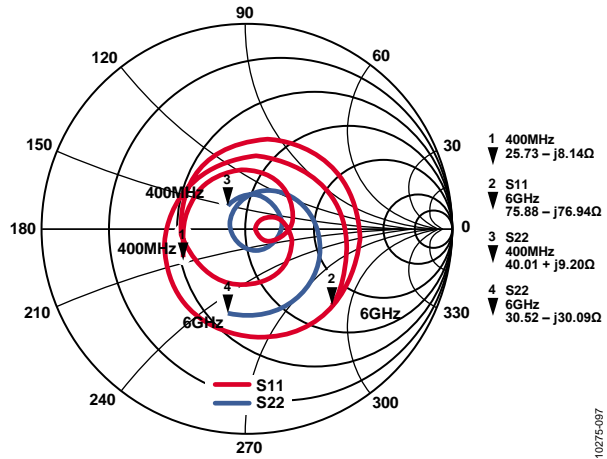

Figure 7. Smith Chart of LOIP (LOIN AC-Coupled to Ground) S11 and RFOUT S22 from 450 MHz to 6000 MHz

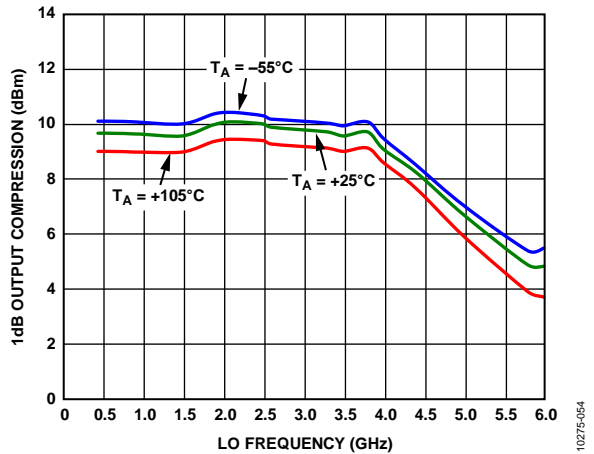

Figure 5. SSB Output 1dB Compression Point ( $OP_{1dB}$ ) vs. LO Frequency ( $f_{LO}$ ) and Temperature

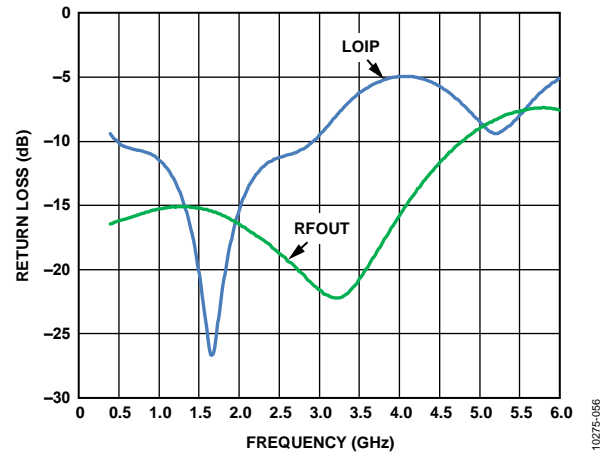

Figure 8. Return Loss of LOIP (LOIN AC-Coupled to Ground) S11 and RFOUT S22 from 450 MHz to 6000 MHz



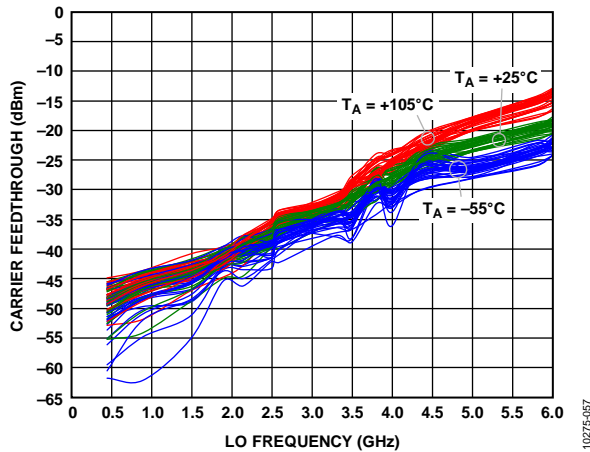

Figure 9. Carrier Feedthrough vs. LO Frequency ( $f_{LO}$ ) and Temperature; Multiple Devices Shown

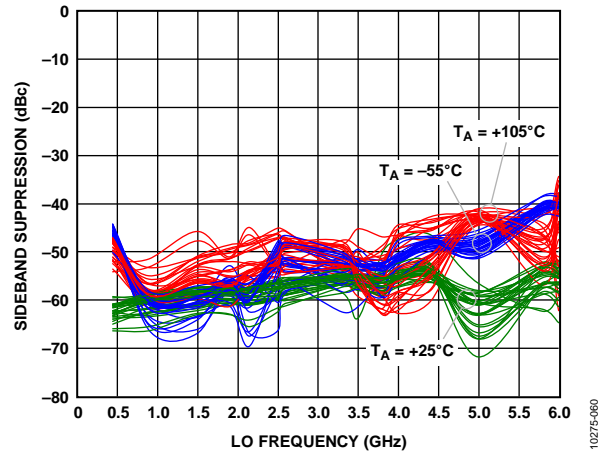

Figure 12. Sideband Suppression vs. LO Frequency ( $f_{LO}$ ) and Temperature After Nulling at 25°C; Multiple Devices Shown

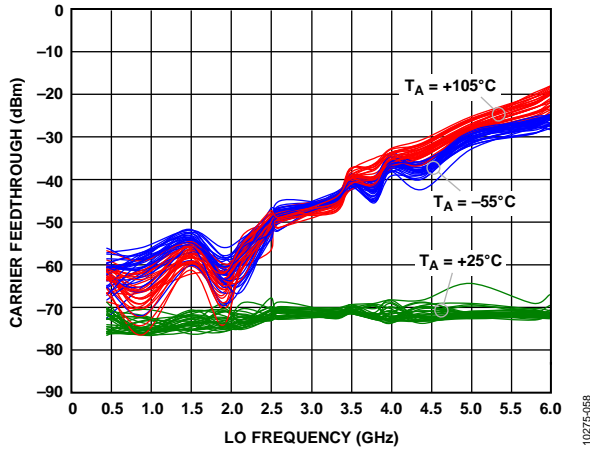

Figure 10. Carrier Feedthrough vs. LO Frequency ( $f_{LO}$ ) and Temperature After Nulling at 25°C; Multiple Devices Shown

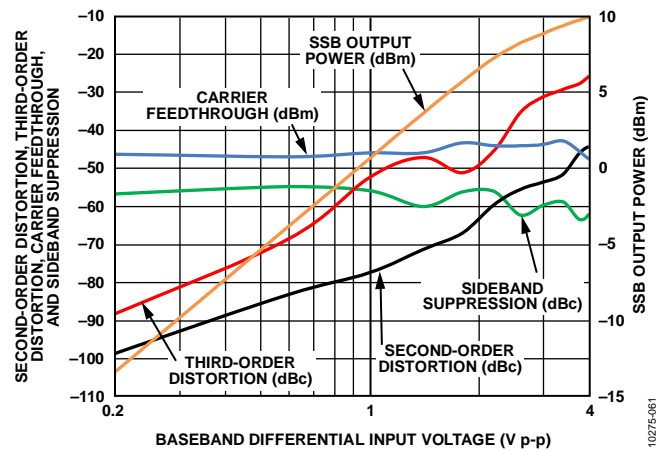

Figure 13. Second- and Third-Order Distortion, Carrier Feedthrough, Sideband Suppression, and SSB  $P_{OUT}$  vs. Baseband Differential Input Level ( $f_{LO} = 900$  MHz)

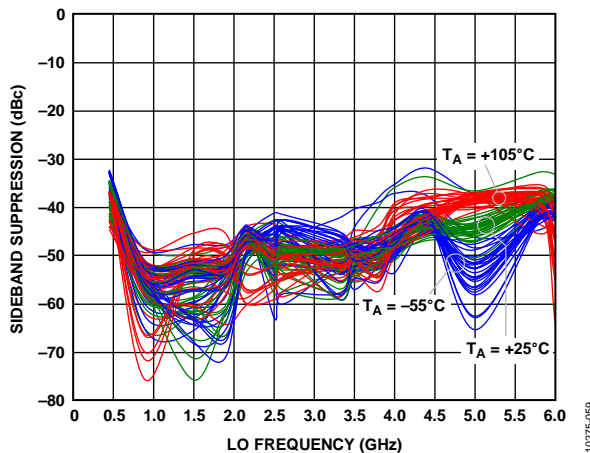

Figure 11. Sideband Suppression vs. LO Frequency ( $f_{LO}$ ) and Temperature; Multiple Devices Shown

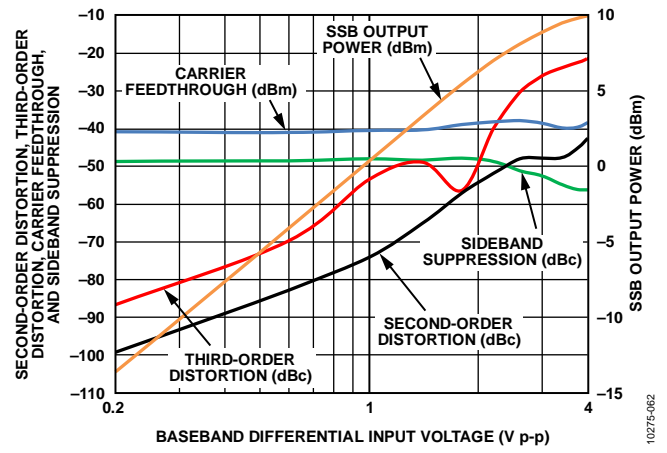

Figure 14. Second- and Third-Order Distortion, Carrier Feedthrough, Sideband Suppression, and SSB  $P_{OUT}$  vs. Baseband Differential Input Level ( $f_{LO} = 2150$  MHz)

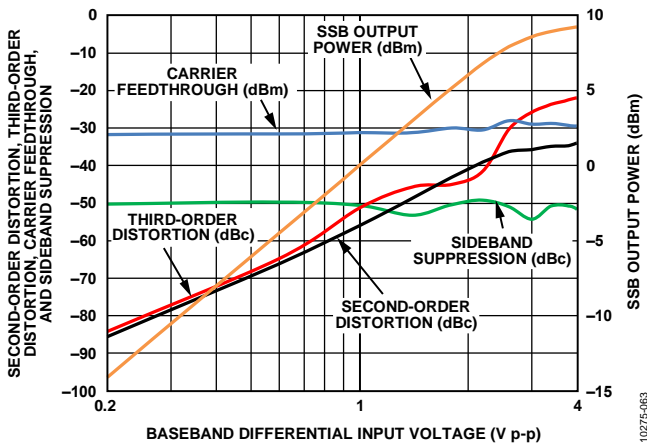

Figure 15. Second- and Third-Order Distortion, Carrier Feedthrough, Sideband Suppression, and SSB  $P_{OUT}$  vs. Baseband Differential Input Level ( $f_{LO} = 3500$  MHz)

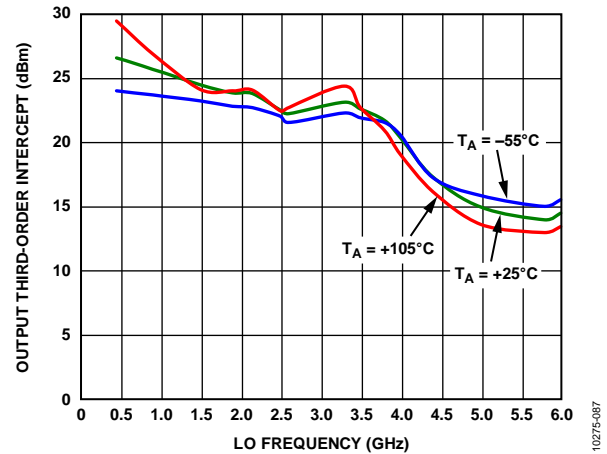

Figure 18. OIP3 vs. LO Frequency ( $f_{LO}$ ) and Temperature ( $P_{OUT} \approx -5$  dBm)

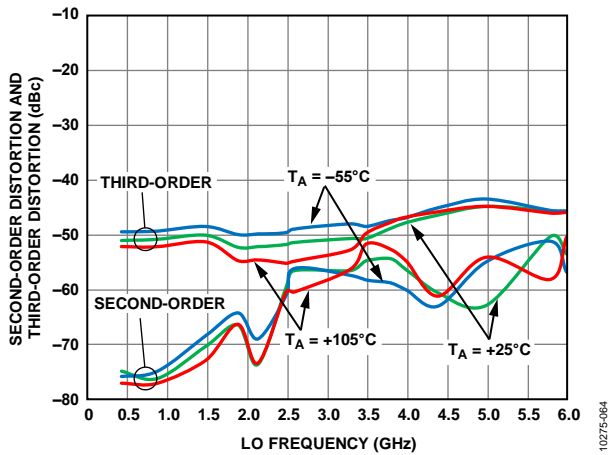

Figure 16. Second- and Third-Order Distortion vs. LO Frequency ( $f_{LO}$ ) and Temperature (Baseband I/Q Amplitude = 1 V p-p Differential)

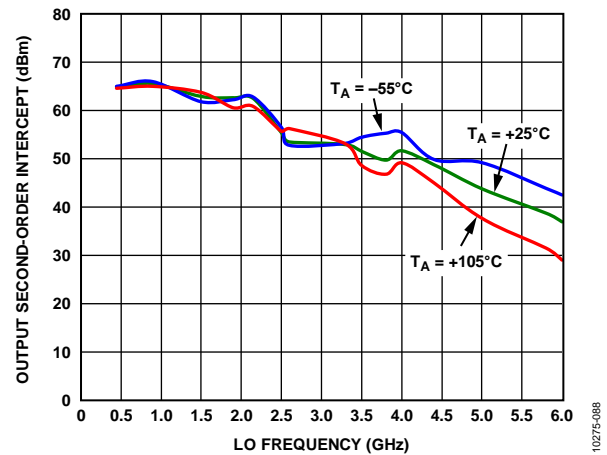

Figure 19. OIP2 vs. LO Frequency ( $f_{LO}$ ) and Temperature ( $P_{OUT} \approx -5$  dBm)

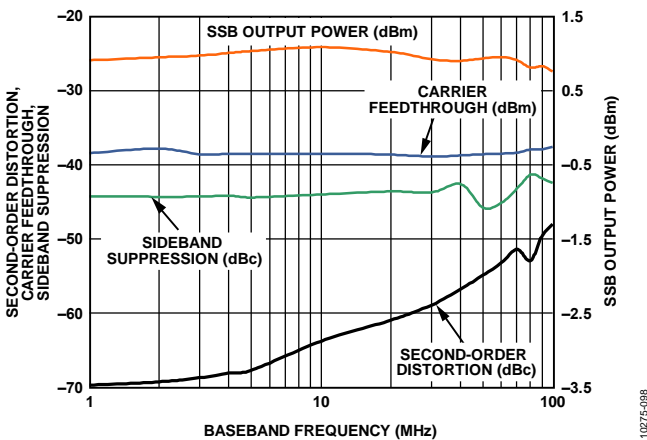

Figure 17. Second-Order Distortion, Carrier Feedthrough, Sideband Suppression, and SSB  $P_{OUT}$  vs. Baseband Frequency ( $f_{BB}$ );  $f_{LO} = 2140$  MHz

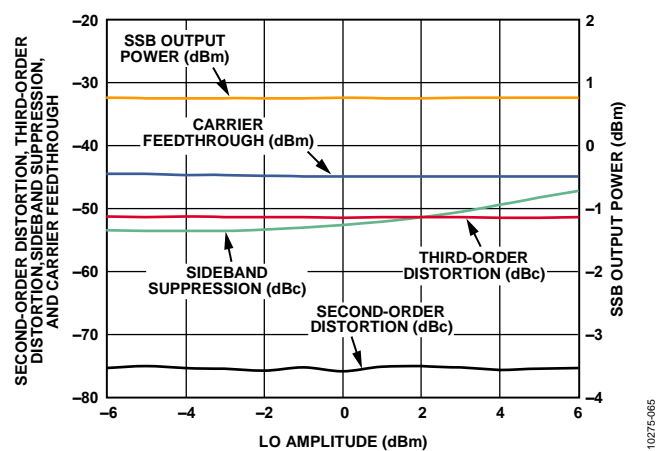

Figure 20. Second- and Third-Order Distortion, Carrier Feedthrough, Sideband Suppression, and SSB  $P_{OUT}$  vs. LO Amplitude ( $f_{LO} = 900$  MHz)

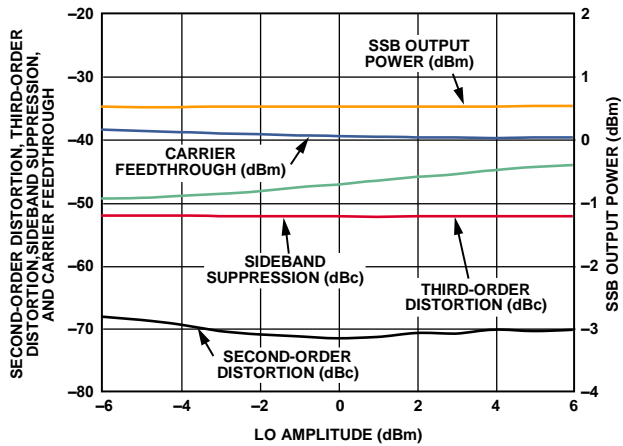

Figure 21. Second- and Third-Order Distortion, Carrier Feedthrough, Sideband Suppression, and SSB  $P_{OUT}$  vs. LO Amplitude ( $f_{LO} = 2150$  MHz)

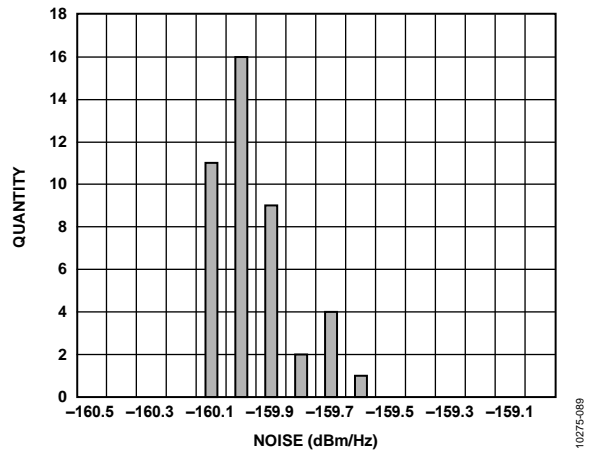

Figure 24. 20 MHz Offset Noise Floor Distribution at  $f_{LO} = 900$  MHz ( $I/Q$  Amplitude = 0 mV p-p with 500 mV DC Bias)

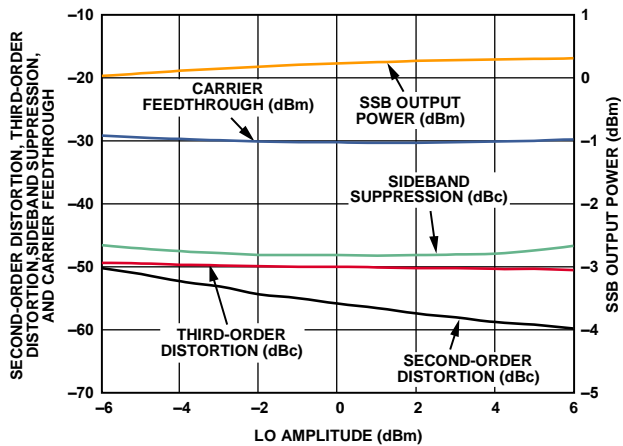

Figure 22. Second- and Third-Order Distortion, Carrier Feedthrough, Sideband Suppression, and SSB  $P_{OUT}$  vs. LO Amplitude ( $f_{LO} = 3500$  MHz)

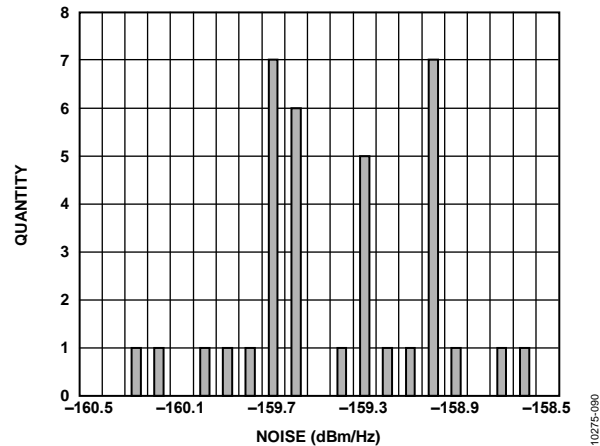

Figure 25. 20 MHz Offset Noise Floor Distribution at  $f_{LO} = 2140$  MHz ( $I/Q$  Amplitude = 0 mV p-p with 500 mV DC Bias)

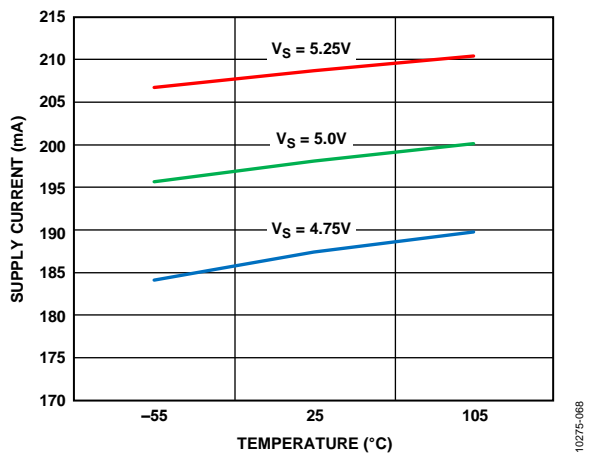

Figure 23. Power Supply Current vs. Temperature

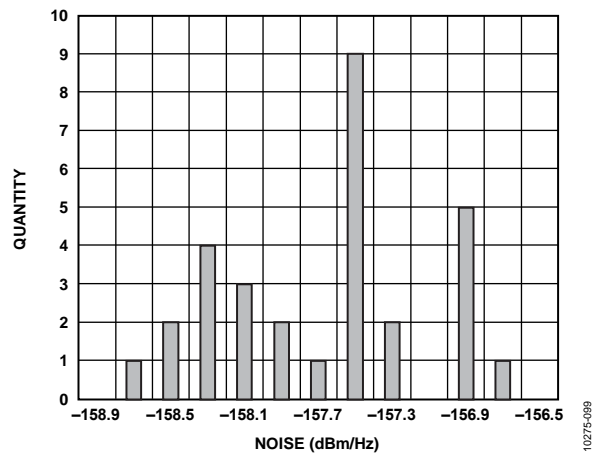

Figure 26. 20 MHz Offset Noise Floor Distribution at  $f_{LO} = 3500$  MHz ( $I/Q$  Amplitude = 0 mV p-p with 500 mV DC Bias)

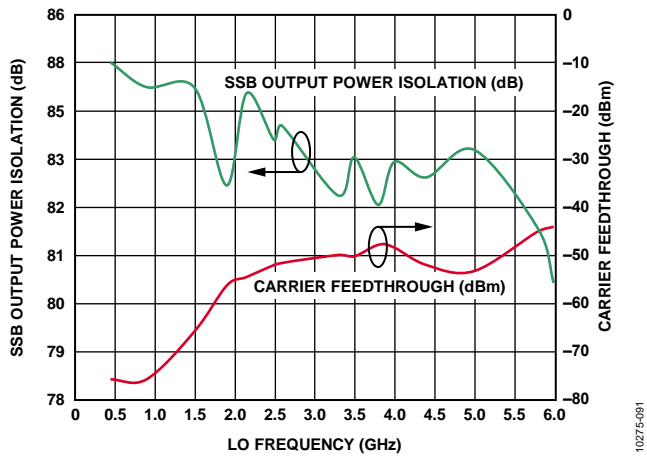
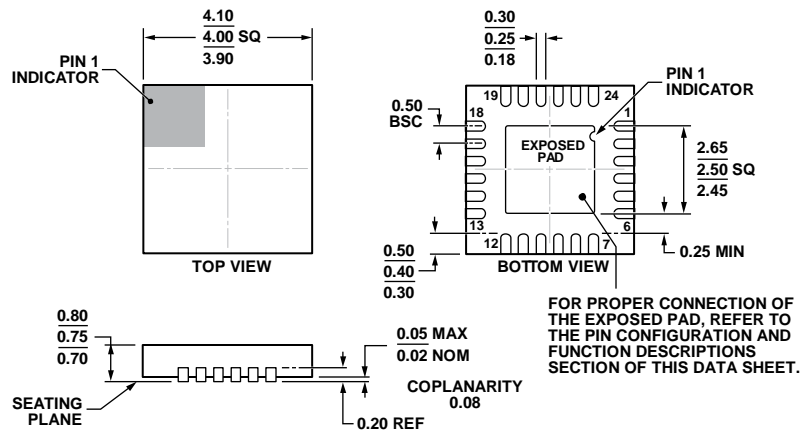

Figure 27. SSB  $P_{OUT}$  Isolation and Carrier Feedthrough with DSOP High

# OUTLINE DIMENSIONS



COMPLIANT TO JEDEC STANDARDS MO-220-WGGD.

Figure 28. 24-Lead Lead Frame Chip Scale Package [LFCSP\_WQ]  
 4 mm × 4 mm Body, Very Very Thin Quad  
 (CP-24-7)  
 Dimensions shown in millimeters

04-12-2012-A

## ORDERING GUIDE

Model <sup>1</sup>	Temperature Range	Package Description	Package Option
ADL5375-05SCPZEPR7	-55°C to +105°C	24-Lead LFCSP_WQ, 7" Tape and Reel	CP-24-7
ADL5375-05EP-EVALZ		Evaluation Board	

<sup>1</sup> Z = RoHS Compliant Part.

**NOTES**

**NOTES**

**NOTES**