

STRADELLA-HB-W

~90° wide beam for industrial applications

SPECIFICATION:

| | |
|----------------|----------------|
| Dimensions | 13.9 x 13.9 mm |
| Height | 7.1 mm |
| Fastening | pin |
| ROHS compliant | yes ⓘ |

MATERIALS:

| Component | Type | Material | Colour | Finish |
|----------------|-------------|----------|--------|--------|
| STRADELLA-HB-W | Single lens | PMMA | clear | |

ORDERING INFORMATION:

| Component | Qty in box | MOQ | MPQ | Box weight (kg) |
|---|------------|------|------|-----------------|
| C15247_STRADELLA-HB-W » Box size: 480 x 250 x 390 mm | 16000 | 1000 | 1000 | 11.9 |



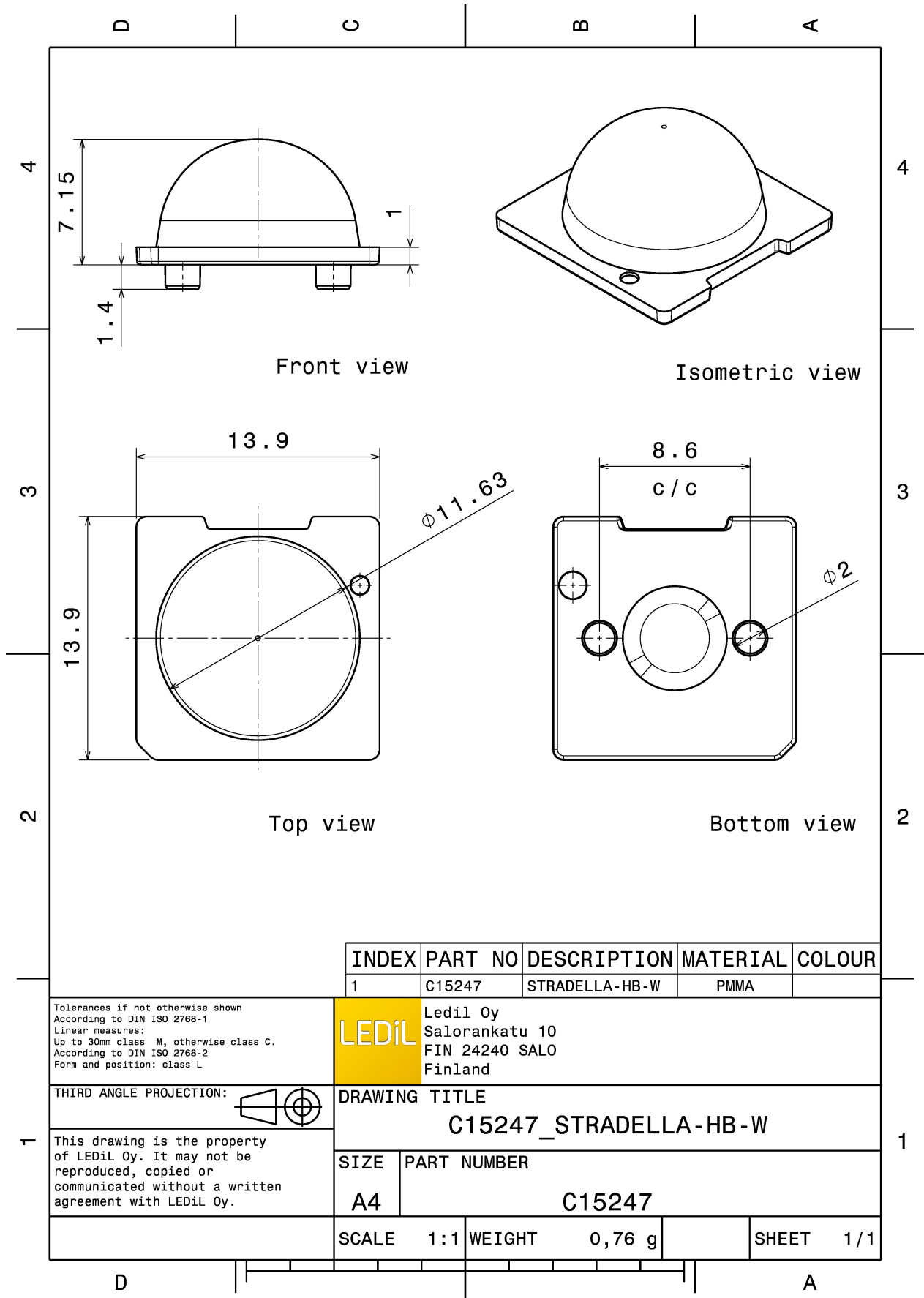

| INDEX | PART NO | DESCRIPTION | MATERIAL | COLOUR |
|-------|---------|----------------|----------|--------|
| 1 | C15247 | STRADELLA-HB-W | PMMA | |

Tolerances if not otherwise shown
According to DIN ISO 2768-1
Linear measures:
Up to 30mm class M, otherwise class C.
According to DIN ISO 2768-2
Form and position: class L

LEDiL Ledil Oy
Salorankatu 10
FIN 24240 SALO
Finland

THIRD ANGLE PROJECTION:

DRAWING TITLE
C15247_STRADELLA-HB-W

This drawing is the property of LEDiL Oy. It may not be reproduced, copied or communicated without a written agreement with LEDiL Oy.

| SIZE | PART NUMBER |
|------|-------------|
| A4 | C15247 |

| SCALE | 1:1 | WEIGHT | 0,76 g | SHEET | 1/1 |
|-------|-----|--------|--------|-------|-----|
|-------|-----|--------|--------|-------|-----|

See also our general installation guide: www.ledil.com/installation_guide

OPTICAL RESULTS (MEASURED):

CREE LED

LED J Series 3030
 FWHM / FWTM 77.0° / 133.0°
 Efficiency 96 %
 Peak intensity 0.6 cd/lm
 LEDs/each optic 1
 Light colour White
 Required components:

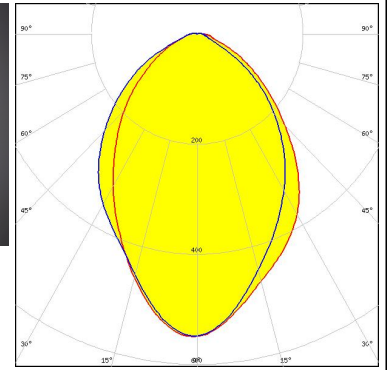

CREE LED

LED XT-E
 FWHM / FWTM 76.0° / 138.0°
 Efficiency 94 %
 Peak intensity 0.5 cd/lm
 LEDs/each optic 1
 Light colour White
 Required components:

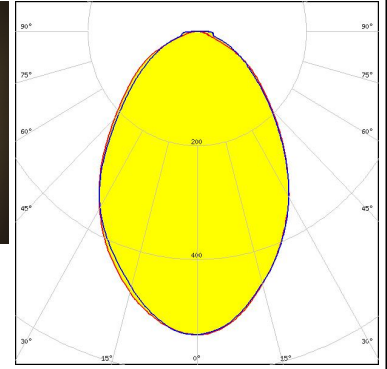

NICHIA

LED NVSW219D
 FWHM / FWTM 83.0° / 131.0°
 Efficiency 94 %
 Peak intensity 0.5 cd/lm
 LEDs/each optic 1
 Light colour White
 Required components:

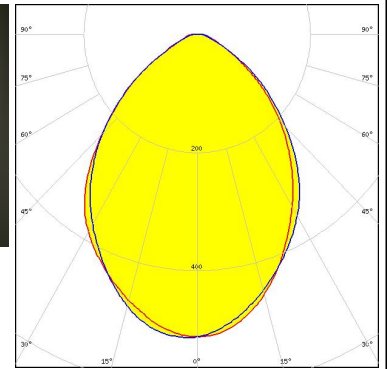
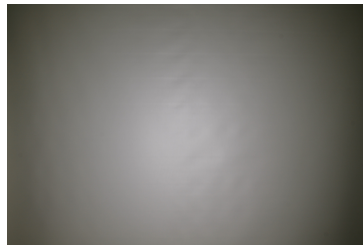

NICHIA

LED NVSW319B
 FWHM / FWTM 92.0° / 139.0°
 Efficiency 94 %
 Peak intensity 0.5 cd/lm
 LEDs/each optic 1
 Light colour White
 Required components:

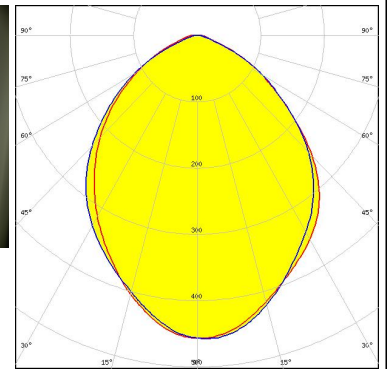
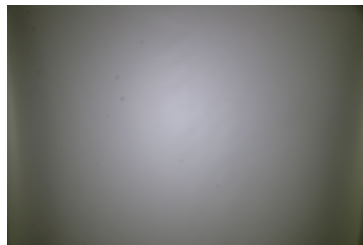

OPTICAL RESULTS (MEASURED):

SAMSUNG

LED LH181B
FWHM / FWTM 77.0° / 131.0°
Efficiency 94 %
Peak intensity 0.5 cd/lm
LEDs/each optic 1
Light colour White
Required components:

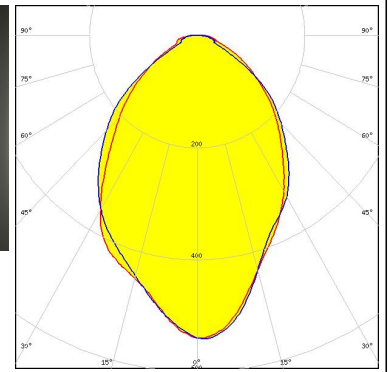
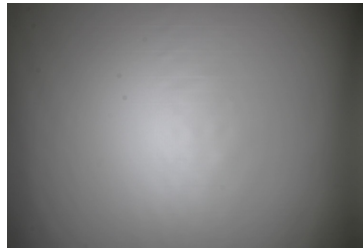

OPTICAL RESULTS (SIMULATED):

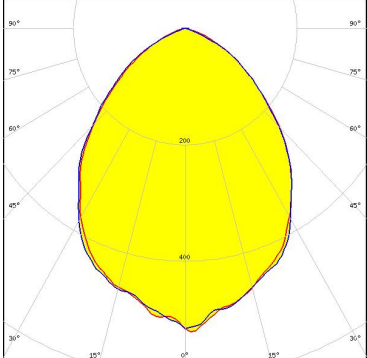
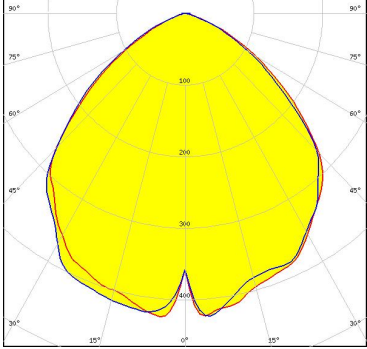
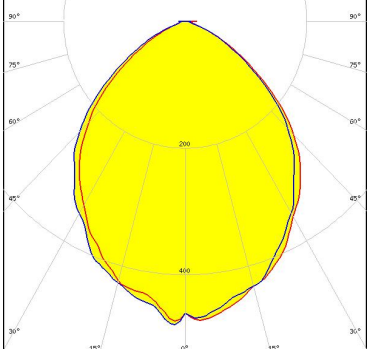
| | |
|--|---|
| <p>CREE → LED</p> <p>LED J Series 2835 FWHM / FWTM 86.0° / 133.0° Efficiency 96 % Peak intensity 0.5 cd/lm LEDs/each optic 1 Light colour White Required components:</p> |  |
| <p>CREE → LED</p> <p>LED XP-E2 FWHM / FWTM 100.0° / 136.0° Efficiency 96 % Peak intensity 0.4 cd/lm LEDs/each optic 1 Light colour Green Required components:</p> |  |
| <p>CREE → LED</p> <p>LED XP-G2 HE FWHM / FWTM 91.0° / 133.0° Efficiency 93 % Peak intensity 0.5 cd/lm LEDs/each optic 1 Light colour White Required components:</p> |  |
| <p>LUMILEDS</p> <p>LED LUXEON IR Domed 150 FWHM / FWTM 115.0° / 150.0° Efficiency 92 % LEDs/each optic 1 Light colour White Required components:</p> | |

OPTICAL RESULTS (SIMULATED):



LED NF2W585AR-P8
 FWHM / FWTM 87.0 + 97.0° / 142.0 + 136.0°
 Efficiency 95 %
 Peak intensity 0.5 cd/lm
 LEDs/each optic 1
 Light colour White
 Required components:

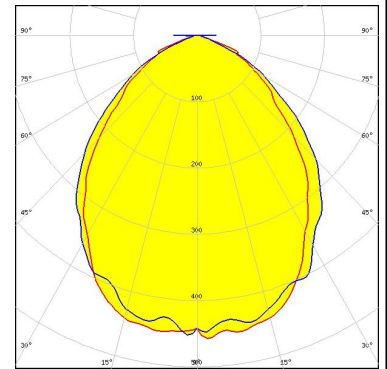

LED NVSW519A
 FWHM / FWTM 93.0° / 130.0°
 Efficiency 90 %
 Peak intensity 0.4 cd/lm
 LEDs/each optic 1
 Light colour White
 Required components:

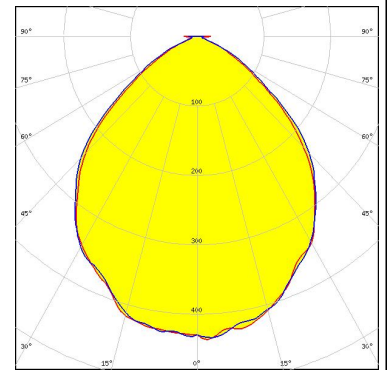

Opto Semiconductors
 LED OSCONIQ C 2424
 FWHM / FWTM 93.0° / 136.0°
 Efficiency 97 %
 Peak intensity 0.5 cd/lm
 LEDs/each optic 1
 Light colour White
 Required components:

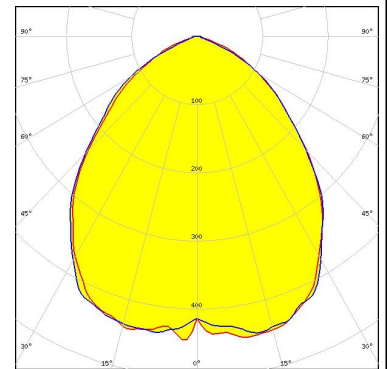

Opto Semiconductors
 LED OSCONIQ P 3030
 FWHM / FWTM 77.0° / 130.0°
 Efficiency 97 %
 Peak intensity 0.6 cd/lm
 LEDs/each optic 1
 Light colour White
 Required components:

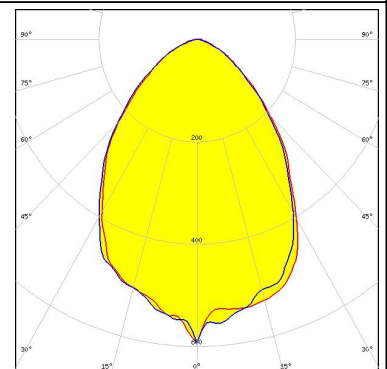

OPTICAL RESULTS (SIMULATED):

OSRAM

Opto Semiconductors

LED OSCONIQ P 3737 (2W version)
FWHM / FWTM 89.0° / 134.0°
Efficiency 94 %
Peak intensity 0.4 cd/lm
LEDs/each optic 1
Light colour White
Required components:

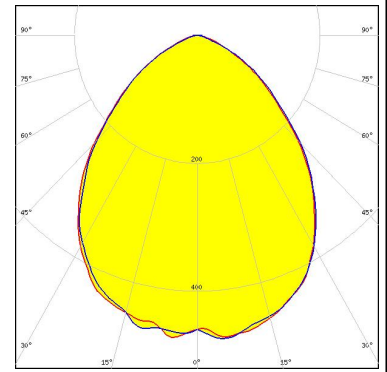

SAMSUNG

LED LH351B
FWHM / FWTM 90.0° / 125.0°
Efficiency 93 %
Peak intensity 0.5 cd/lm
LEDs/each optic 1
Light colour White
Required components:

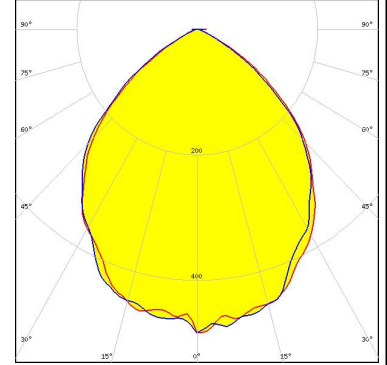

SEOUL SEMICONDUCTOR

LED Z8Y22T
FWHM / FWTM 90.0° / 134.0°
Efficiency 94 %
Peak intensity 0.5 cd/lm
LEDs/each optic 1
Light colour White
Required components:

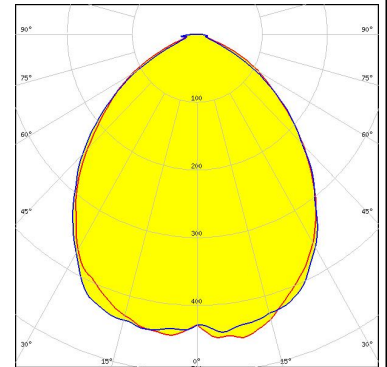

GENERAL INFORMATION:

NOTE: The typical beam angle will be changed by different color, chip size and chip position tolerance. The typical total beam angle is the full angle measured where the luminous intensity is half of the peak value.

MATERIALS:

As part of our continuous research and improvement processes, and to ensure the best possible quality and availability of our products, LEDiL reserves the right to change material grades without notice.

PRODUCT DATA USER AGREEMENT AND DISCLAIMER:

The measured data in the provided downloadable LEDiL Product Datasheets and Mechanical 2D-Drawings is rounded and provided as reference for planning. LEDiL Oy's optical specifications have been verified by conducting performance testing of the products in accordance with the company's quality system. The reported data are averaged results of multiple measurements with typical variation. LEDiL Oy reserves the right to without prior notification make changes and improvements to its products.

LEDiL Oy assumes neither warranty, nor guarantee nor any other liability of any kind for the contents and correctness of the provided data. The provided data has been generated with highest diligence but the provided data may in reality not represent the complete possible variation range of all intrinsic parameters. Therefore, in certain cases a deviation from the provided data could occur.

LEDiL Oy reserves the right to undertake technical changes of its products without further notification which could lead to changes in the provided data. LEDiL Oy assumes no liability of any kind for the possible deviation from any provided data or any other damage resulting from the usage of the provided data.

The user agrees to this disclaimer and user agreement with the download or usage of the provided files.

LEDiL Oy

Joensuunkatu 13
FI-24240 SALO
Finland

LEDiL Inc.

228 West Page Street
Suite D
Sycamore IL 60178
USA

Ledil Optics Technology (Shenzhen) Co., Ltd.

405 , Block B
Casic Motor Building
Shenzhen 518057
P.R.CHINA

Local sales and technical support

[www.ledil.com/
where_to_buy](http://www.ledil.com/where_to_buy)

Shipping locations

Salo, Finland
Hong Kong, China

Distribution Partners

[www.ledil.com/
where_to_buy](http://www.ledil.com/where_to_buy)