

User Manual

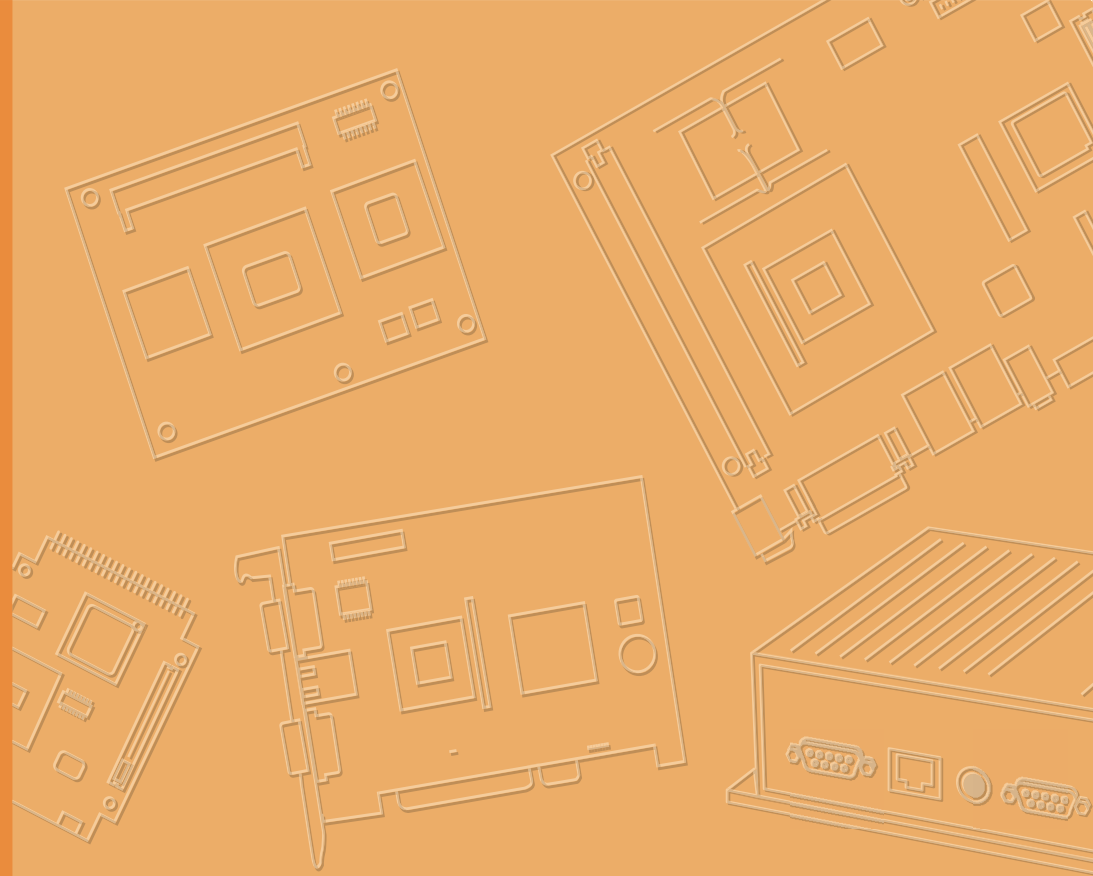

UTC-318

**Intel® Celeron® J1900
Processor-based Ubiquitous
Touch Computer with 18.5" TFT
LCD**

ADVANTECH

Enabling an Intelligent Planet

Copyright

The documentation and software included with this product are copyrighted 2015 by Advantech Co., Ltd. All rights are reserved. Advantech Co., Ltd. also reserves the right to improve the products described in this manual at any time without notice. No part of this manual may be reproduced, copied, translated, or transmitted in any form or by any means without the prior written permission of Advantech Co., Ltd. Information provided in this manual is intended to be accurate and reliable. However, Advantech Co., Ltd. assumes no responsibility for its use, nor for any infringements of the rights of third parties that may result from its use.

Acknowledgements

Award is a trademark of Award Software International, Inc.

Intel®, Celeron®, and Pentium® are trademarks of Intel Corporation.

IBM, PC/AT, PS/2, and VGA are trademarks of International Business Machines Corporation.

Microsoft Windows® is a registered trademark of Microsoft Corp.

RTL is a trademark of Realtek Semiconductor Co., Ltd.

All other product names or trademarks are the property of their respective owners.

For more information about this and other Advantech products, please visit our website at

<http://www.advantech.com>

or

<http://www.advantech.com/ppc>

For technical support and service, please visit our support website at

<http://support.advantech.com>

Declaration of Conformity

FCC Class A

Note: This equipment has been tested and found to comply with the limits for a Class B digital device, pursuant to part 15 of the FCC Rules. These limits are designed to provide reasonable protection against harmful interference in a residential installation. This equipment generates, uses and can radiate radio frequency energy and, if not installed and used in accordance with the instructions, may cause harmful interference to radio communications. However, there is no guarantee that interference will not occur in a particular installation. If this equipment does cause harmful interference to radio or television reception, which can be determined by turning the equipment off and on, the user is encouraged to try to correct the interference by one or more of the following measures:

- Reorient or relocate the receiving antenna.
- Increase the separation between the equipment and receiver.
- Connect the equipment into an outlet on a circuit different from that to which the receiver is connected.
- Consult the dealer or an experienced radio/TV technician for help.

Warning! *Any changes or modifications made to the equipment which are not expressly approved by the relevant standards authority could void your authority to operate the equipment.*



Packing List

Before installation, please ensure that the following materials have been shipped:

- UTC-318 device
- Accessories for UTC-318
 - 1 x warranty card
 - 1 x adapter
 - 1 x SATA cable
 - 1 x packet of screws

If any of these items are missing or damaged, contact your distributor or sales representative immediately.

Technical Support and Assistance

1. Visit the Advantech website at <http://support.advantech.com> to obtain the latest product information.
2. Contact your distributor, sales representative, or Advantech's customer service center for technical support if you need additional assistance. Please have the following information to hand before calling:
 - Product name and serial number
 - Description of your peripheral attachments
 - Description of your software (operating system, version, application software, etc.)
 - Comprehensive description of the problem
 - The exact wording of any error messages

Safety Instructions

1. Read these safety instructions carefully.
2. Retain this user manual for future reference.
3. Disconnect this equipment from all AC outlets before cleaning. Use only a damp cloth to clean the equipment. Do not use liquid or spray detergents.
4. For pluggable equipment, the power outlet socket should be located near the equipment and easily accessible.
5. Protect this equipment from humidity.
6. Place this equipment on a reliable surface during installation. Dropping or letting the device fall may cause damage.
7. The openings on the enclosure are for air convection to prevent the system from overheating. Do not cover the openings.
8. Ensure that the power source voltage is correct before connecting the equipment to the power outlet.
9. Position the power cord away from high-traffic areas. Do not place anything over the power cord.
10. All cautions and warnings on the equipment should be noted.
11. If idle for a long time, disconnect the equipment from the power source to avoid damage from transient overvoltage.
12. Never pour liquid into any openings of the device. This may cause fire or electrical shock.
13. Never open the equipment. For safety reasons, the equipment should only be opened by qualified service personnel.
14. If one of the following occurs, have the equipment checked by service personnel:
 15. The power cord or plug is damaged.
 16. Liquid has penetrated into the equipment.
 17. The equipment has been exposed to moisture.
 18. The equipment is malfunctioning, or does not operate according to the user manual.
 19. The equipment has been dropped and damaged.
 20. The equipment shows obvious signs of breakage.
21. Do not store this equipment in an environment where the temperature fluctuates below $-20\text{ }^{\circ}\text{C}$ ($-4\text{ }^{\circ}\text{F}$) or above $60\text{ }^{\circ}\text{C}$ ($140\text{ }^{\circ}\text{F}$) as this may cause damage. The equipment should be stored in a controlled environment.
22. Batteries are at risk of exploding if incorrectly replaced or substituted. Replace only with the same or equivalent type recommended by the manufacturer. Discard used batteries according to the manufacturer's instructions.
23. The sound pressure level at the operator's position does not exceed 70 dB (A), as per the IEC 704-1:1982.

DISCLAIMER: These instructions are provided in accordance with the IEC 704-1. Advantech disclaims all responsibility for the accuracy of any statements contained herein.

Contents

Chapter 1	General Information	1
1.1	Introduction	2
1.2	General Specifications	2
1.2.1	General	2
1.2.2	Standard Functions	2
1.2.3	Audio Function	2
1.2.4	LAN Function	2
1.2.5	Touchscreen (Optional)	3
1.2.6	Environment	3
1.3	LCD Specifications	4
1.4	Optional Modules	4
1.5	Dimensions	5
	Figure 1.1 UTC-318 Dimensions	5
Chapter 2	System Setup	7
2.1	System Description	8
	Figure 2.1 UTC-318 Front View	8
	Figure 2.2 UTC-318 Rear View	8
2.2	Installation Procedures	9
2.2.1	Connecting the Power Cord	9
2.2.2	Connecting the Keyboard or Mouse	9
2.2.3	Switching on the Power	9
	Figure 2.3 Connecting the Power Cord to the DC Inlet	9
2.3	BIOS Setup Program Operation	10
2.4	System Software Installation	13
2.4.1	Method 1: Ethernet	13
2.4.2	Method 2: External USB CD-ROM	13
2.5	Driver Installation	13
Chapter 3	Hardware Installation and Upgrades ...	15
3.1	Introduction	16
3.2	2.5" Hard Disk Drive Installation	16
	Figure 3.1 Primary 2.5" HDD Installation	16
3.3	mSATA Card Installation	17
	Figure 3.2 mSATA Card Installation	17
3.4	WLAN Installation	18
Chapter 4	Jumper Settings and Connectors	21
4.1	Jumpers and Connectors	22
4.1.1	Setting Jumpers	22
4.1.2	Jumpers and Connectors	23
	Table 4.1: Jumper and Connector Functions	23
4.1.3	Jumper and Connector Locations	24
	Figure 4.1 Jumper and Connector Locations	24
4.2	Jumpers	25
4.2.1	Jumper List	25
	Table 4.2: Jumper List	25

4.2.2	Jumper Settings.....	25
	Table 4.3: JP1: LCD Power.....	25
	Table 4.4: JP3: Clear CMOS.....	25
	Table 4.5: JP4: AT/ATX Power SEL.....	26
	Table 4.6: CN17: COM1 Ring.....	26

Appendix A I/O Pin Assignments 27

A.1	PIN Assignments.....	28
	Table A.1: CN1: Backlight.....	28
	Table A.2: CN3: Internal USB.....	28
	Table A.3: CN4: LVDS.....	29
	Table A.4: CN6: SATA.....	30
	Table A.5: CN7: SATA Power.....	30
	Table A.6: CN8: Internal USB.....	31
	Table A.7: CN9: Touch.....	31
	Table A.8: CN13: DDR3L SODIMM.....	32
	Table A.9: MINI PCIE1: Mini PCIe.....	33
	Table A.10:MSATA1: MSATA.....	34
	Table A.11:CN16: COM2.....	36
	Table A.12:CN18: COM1.....	37
	Table A.13:CN21: Power Switch.....	37
	Table A.14:CN22: Speakers.....	38
	Table A.15:CN23: LAN1/LAN2.....	38
	Table A.16:CN24: External USB.....	38
	Table A.17:CN25: External USB.....	39
	Table A.18:CN26: External USB.....	39
	Table A.19:CN27: Line Out.....	40
	Table A.20:CN28: Mic In.....	40
	Table A.21:CN30: HDMI.....	41
	Table A.22:CN31: DC-In.....	42
	Table A.23:SW2 Button: Power Button.....	42

Chapter 1

General Information

This chapter gives background information on the UTC-318.

- Introduction
- General Specifications
- LCD Specifications
- Optional Modules
- Dimensions

1.1 Introduction

UTC-318x is the multi-purpose all-in-one computing system which equipped with wide format, touch based LCD panel. It is easy to integrate key peripherals and display systems for diversified self-service and interactive signage deploy in different application areas. With the removable frame, the system also could fulfill industries or control system applications with panel mounting design. UTC series touch panel computers are the best investments to enhance user satisfaction, further brand equity, and maximize business profits.

1.2 General Specifications

1.2.1 General

- **Dimensions:** 475 (L) x 295 (H) x 43.5 mm (D)
- **Weight:** 5.0 kg
- **Power adaptor:** AC/DC (standard) 12 V, 84 W
Input voltage: 100 ~ 240 V_{AC}
Output voltage: 12 V @ 7 A
- **Disk drive housing:** Supports one 2.5" SATA HDD
- **Front panel:** IP65

1.2.2 Standard Functions

- **CPU:** Intel® Celeron J1900 at 2.0 GHz with 2 MB L2 cache
- **BIOS:** AMI 16 MB Flash BIOS via SPI
- **System chipset:** Intel® Celeron J1900
- **System memory:** 1 x SODIMM DDR3L 1333 MHz up to 8 GB
- **Serial ports:** 1 x RS-232 COM, 1 x RS-232/422/ 85
- **Universal serial bus (USB) port:** Supports up to 5 x USB 2.0 and 1 x USB 3.0
- **Mini PCIe bus expansion slot:** Supports 1 mini PCIe device (wireless LAN card)
- **Watchdog timer:** Single chip watchdog 255-level interval timer, setup by software
- **Power management:** Full ACPI (Advanced Configuration and Power Interface) 2.0 supports S0, S3, S4, and S5

1.2.3 Audio Function

- **Audio:** High definition (HD) audio, 1 W x 2 speakers
- Optional - Audio output function

1.2.4 LAN Function

- **Chipset:** LAN1 Intel WGI211AT, LAN2 Intel WGI211AT
- **Speed:** 1000 Mbps /Interface: 2 x RJ45
- **Wake-on-LAN:** Supports Wake-on-LAN function with ATX power control
- Supports LAN teaming (in fault tolerance)

1.2.5 Touchscreen (Optional)

Type	Analog, 5-wire resistive (Res. flat glass) / Projected capacitive touch panel (Pcap. flat glass)
Light Transmission	80%
Controller	USB interface
Durability (touches per lifetime)	36 million

1.2.6 Environment

- **Operating temperature:** 0 ~ 40 °C (32 ~ 104 °F)
- **Storage temperature:** -20 ~ 60 °C
- **Relative humidity:** 10 ~ 95% @ 40 °C (non-condensing)
- **Shock:** 10 G peak acceleration (11 ms duration)
- **Certification:** EMC: CE, FCC, BSMI, VCCI.
Safety: UL 60950, CB, CCC, BSMI
- **Vibration:** 5 ~ 500 Hz 0.5 G RMS random vibration
- **VESA support:** 100 x 100 mm (screw type M4 x 5 recommended)

Caution! Use suitable mounting apparatus to avoid injury.



- Supports both landscape and portrait screen orientation

Note! Please follow the instructions for UTC-318 installation.



1.3 LCD Specifications

- **Display type:** 18.5" TFT LCD
- **Max. resolution:** 1366 x 768
- **Colors:** 16.7M
- **Pixel pitch (µm):** 300 (H) x 300 (V)
- **Viewing angle:** 170°/160°
- **Luminance:** 250 cd/m²

Note!  The UTC-318 color LCD display is high quality and reliable. However, the display may have a few defective pixels that do not consistently illuminate. Current technology is unable to completely eliminate defective pixels. However, Advantech is actively working to improve this technology.

1.4 Optional Modules

- **Memory:** 1 x SODIMM DDR3L 1333 MHz up to 8 GB
- **HDD:** 2.5" SATA HDD
- **Operating system:** Windows Embedded Standard 7, Windows Embedded Standard 8, Embedded Linux 3.0
- **Touchscreen:** Analog resistive (UTC-318D-RE/UTC-318D-PE with optional PCT solution)
- **Power cord:** 1702002600 (US), 1702002605 (Europe)
- **Wireless LAN module:**

Part No.	Description
968EMW0065	802.11 abgn Intel 62205AN.HMWEBC Taylor P/2T2R
1750006682-01	Main antenna for wireless LAN, 200 mm

1.5 Dimensions

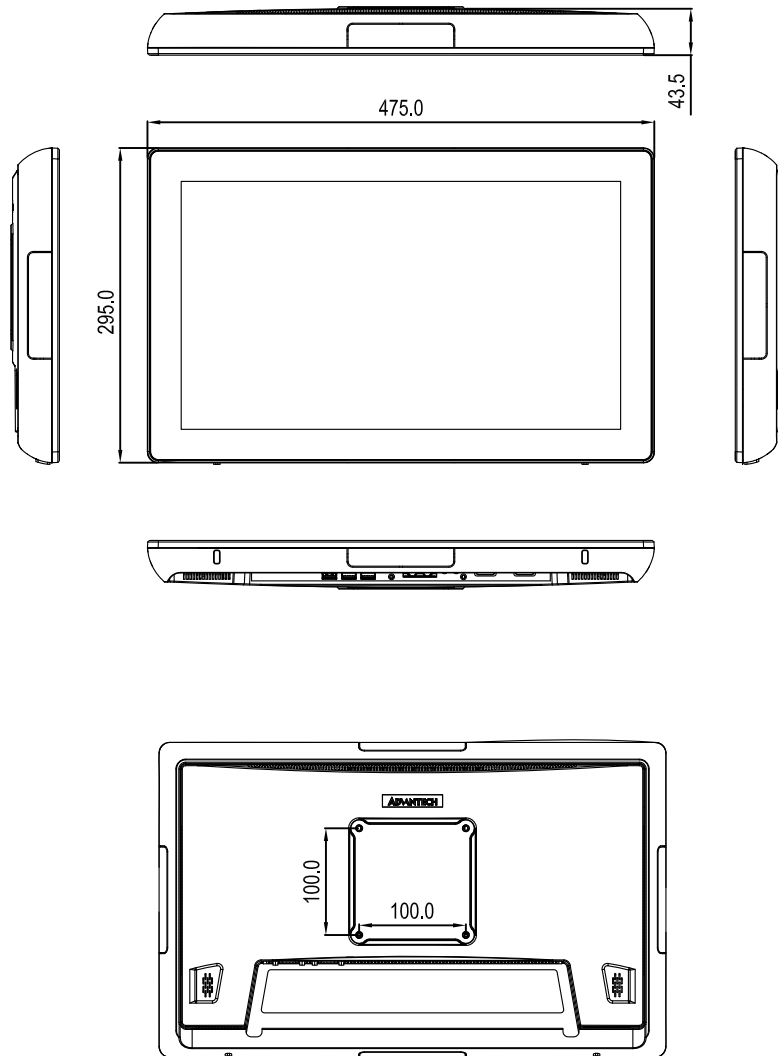

Figure 1.1 UTC-318 Dimensions

Chapter 2

System Setup

This chapter details the UTC-318 system setup process.

- System Description
- Installation Procedures
- BIOS Setup Program Operation
- System Software Installation
- Driver Installation

2.1 System Description

Before beginning the UTC-318 system setup, users are advised to familiarize themselves with the locations and functions of the controls, drivers, connectors, and ports, as shown in the figures below.

The front panel of the UTC-318 is shown in Figure 2.1.

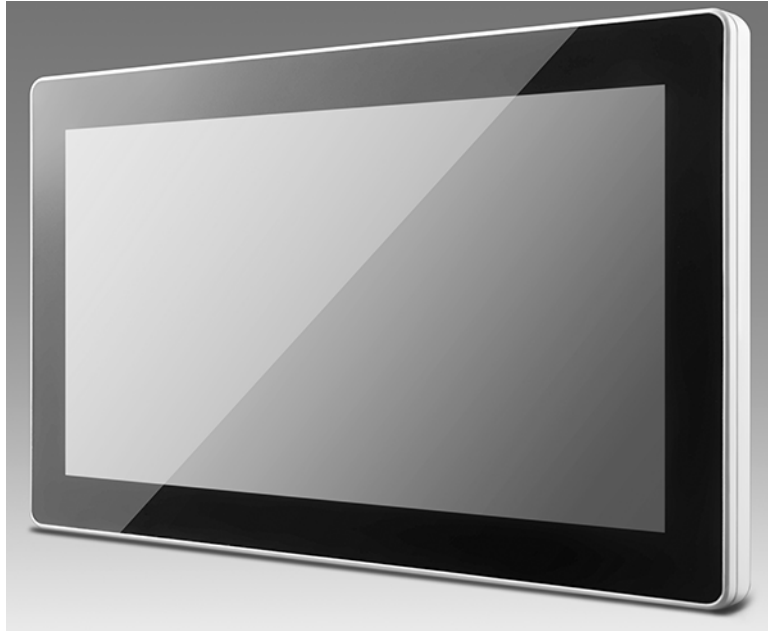
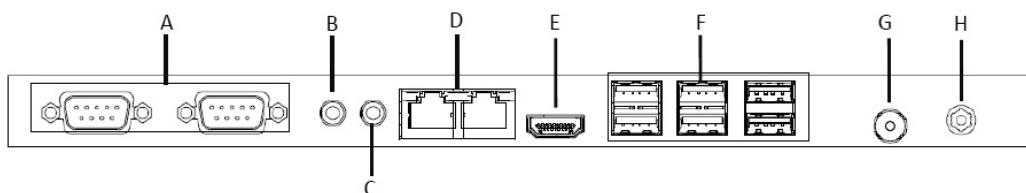

Figure 2.1 UTC-318 Front View

The UTC-318 rear cover and I/O are shown in Figure 2.2. (The system features rich I/O, including serial, Ethernet, USB, HDMI, line-out, mic-in, and DC-in ports, as well as a power button.)



Figure 2.2 UTC-318 Rear View



- | | |
|-----------------|--------------------------|
| A. COM port | B. Line-out |
| C. Mic-in | D. Gigabit LAN x2 |
| E. HDMI | F. USB 2.0 x5/USB 3.0 x1 |
| G. Power switch | H. DC-in |

2.2 Installation Procedures

2.2.1 Connecting the Power Cord

The UTC-318 is powered by DC voltage from an electrical outlet. When handling power cords, hold the plug ends only. Please refer to Figure 2.3 regarding connecting the male plug of the power cord to the DC inlet of the UTC-318.

2.2.2 Connecting the Keyboard or Mouse

Before you start the computer, please connect keyboard port on the I/O section of the UTC-318.

2.2.3 Switching on the Power

The power switch is located at the rear of the UTC-318, as shown in Figure 2.3.



Figure 2.3 Connecting the Power Cord to the DC Inlet

2.3 BIOS Setup Program Operation

Although UTC-318 systems are typically setup and configured by dealers prior to delivery, users may wish to adjust the system configuration, such as the date/time or hard drive type, using the UTC-318 BIOS Setup program. The setup program is stored in read-only memory (ROM) and can be accessed by resetting the system and pressing the “Del” key on the keyboard immediately after the computer powers on.

The settings specified using the setup program are recorded in CMOS RAM memory. This memory is backed up by a battery to ensure the settings are retained when the system is turned off or reset. When powered on, the system reads the settings stored in CMOS RAM and compares them with the results of the power-on self-test (POST). If a discrepancy is identified, an error message is displayed on screen and users are prompted to run the setup program.

BIOS Setup

When installing the OS, please select Chipset → South Bridge.



Select OS Selection [Windows 8.x/ Android / Windows7]

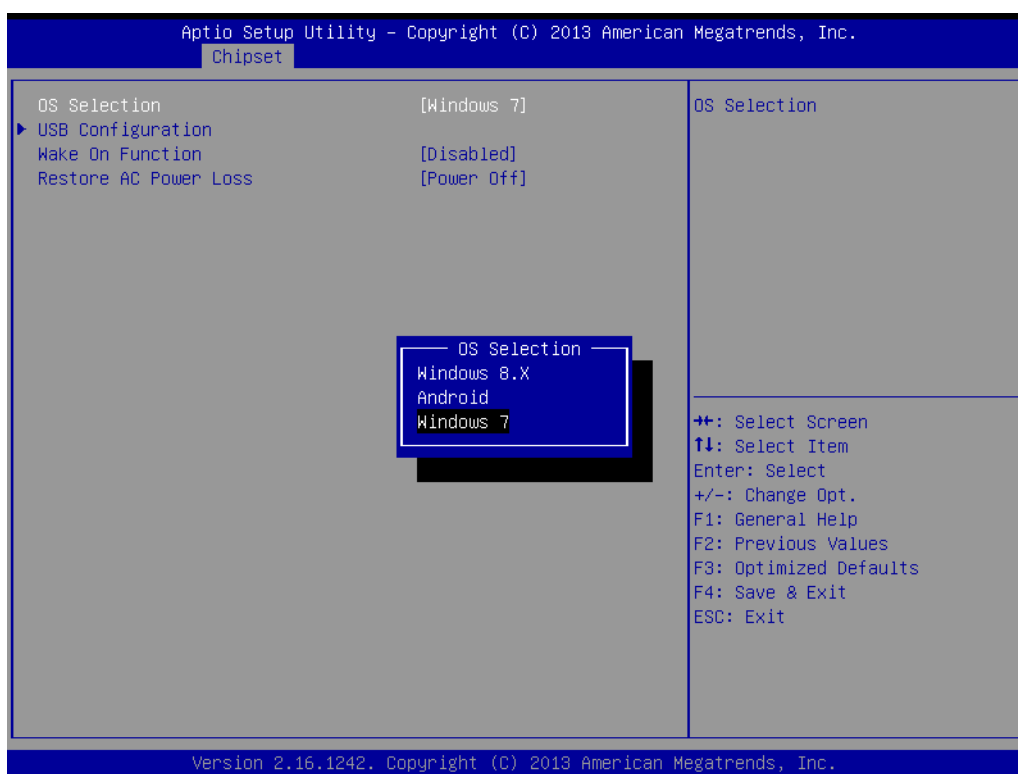

COM2 RS232/RS422/RS485 Selection:

Enter the BIOS Setup → Advanced → NCT6106D Super I/O Configuration

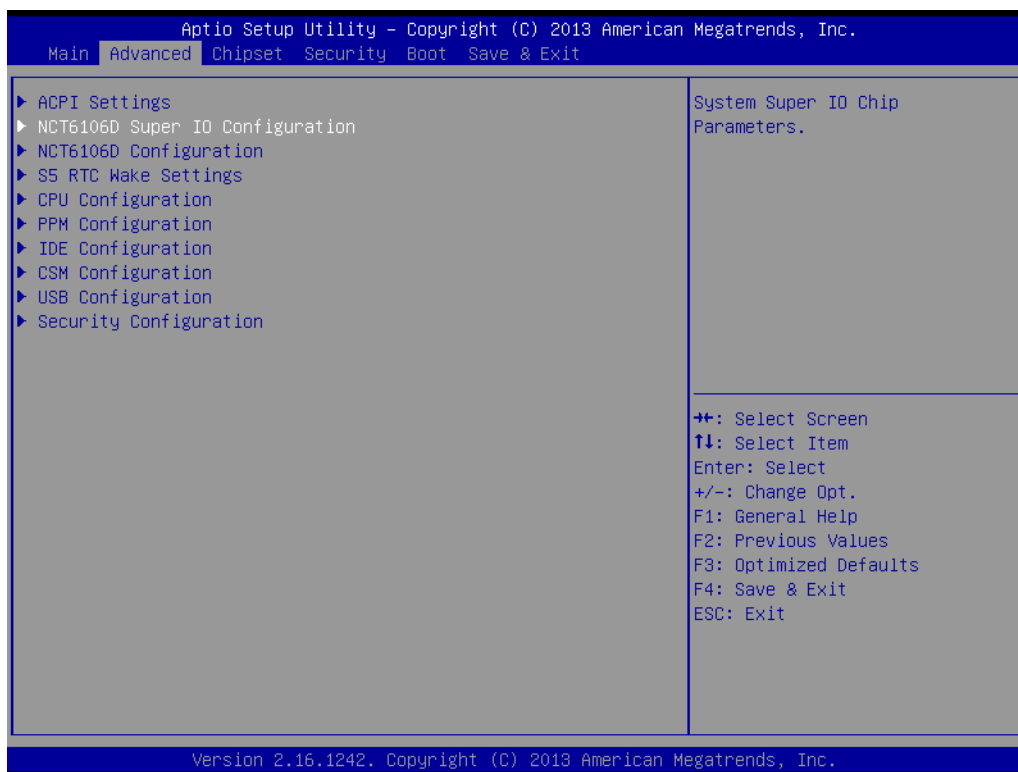

Select Serial Port 2 Configuration

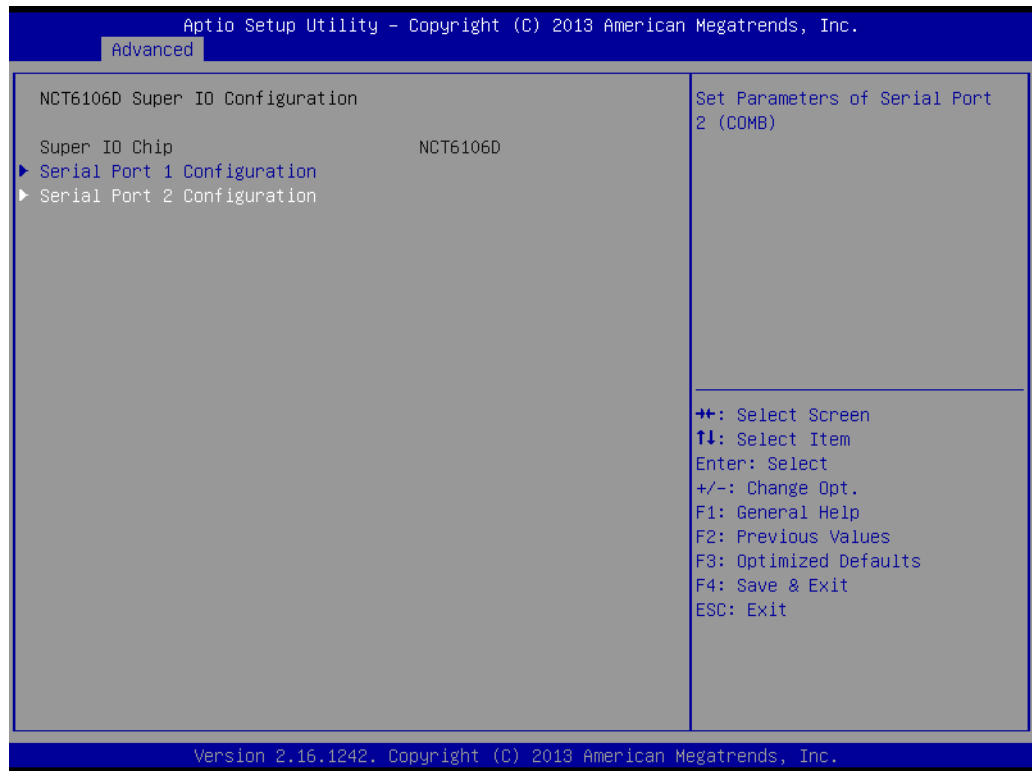

Change the Serial Port 2 mode [RS232/RS422/RS485]

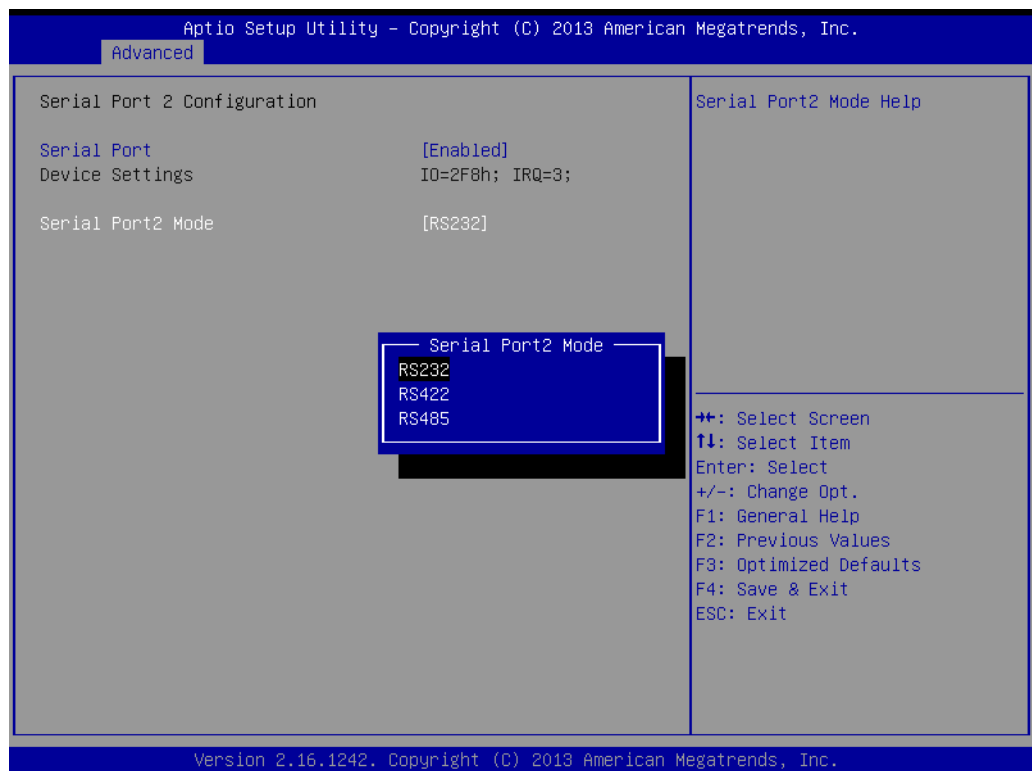

2.4 System Software Installation

Recent OS releases from major vendors include setup programs that automatically load and guide users through the hard disk preparation and OS installation process. The guidelines below explain the procedures for OS installation on the UTC-318 hard drive.

Note! *Some distributors and system integrators may pre-install software onto the UTC-318 prior to shipment.*



An installed HDD is necessary to conduct software installation. Software can be loaded onto the UTC-318 using any one of the four methods explained below.

2.4.1 Method 1: Ethernet

Download software to the HDD via the Ethernet port.

2.4.2 Method 2: External USB CD-ROM

Insert the OS installation or setup CD into the diskette drive.

The UTC-318 BIOS setup utility supports system boot-up directly from the CD-ROM drive. The system installation CD-ROM can also be inserted into the CD-ROM drive.

Power on or reset the system by pressing “Ctrl+Alt+Del” simultaneously. The system will automatically load the OS from the diskette or CD-ROM.

If presented with the initial screen of a setup or installation program, follow the instructions provided on screen. The setup program is designed to guide users through the hard drive preparation and OS installation process. If presented with an OS command line prompt, such as A:\>, users must partition and format the hard drive before manually copying the OS files to the hard drive. Please refer to the OS user manual for instructions regarding partitioning and formatting a hard drive.

2.5 Driver Installation

After installing the system software, users can setup the Ethernet, chipset, graphics, audio, USB3.0, and touchscreen functions. The relevant drivers can be downloaded from the Advantech website.

Note! *The UTC-318 drivers and utilities are subject to change without notice.*



If in doubt, check Advantech’s website or contact our application engineers for the latest information on drivers and utilities.

Chapter 3

Hardware Installation and Upgrades

This chapter explains the UTC-318 hardware installation and upgrade process.

- Introduction
- 2.5" Hard Disk Drive Installation
- mSATA Card Installation
- WLAN Installation

3.1 Introduction

The UTC-318 is a touch panel computer housed in a plastic enclosure. For HDD, DRAM, or mini-SATA card installation, simply remove the rear cover. All maintenance or hardware upgrades can be easily completed upon removal of the rear cover.

Warning! For all servicing and maintenance operations, do not remove the rear cover before verifying that the UTC-318 is disconnected from the power source. The device power must be switched off and the power cord unplugged.



3.2 2.5" Hard Disk Drive Installation

The internal controller of the UTC-318 can accommodate one SATA HDD. The SATA controller enables the SATA HDD to exceed 150 MB and supports faster data transfer speeds. Instructions for installation are provided below.

1. Detach and remove the rear cover.
2. Place the HDD in the metal bracket, and tighten the screws (see Figure 3.1).
3. Locate the HDD cable (SATA 7P+1*5P-2.5/SATA(15+7)P) near the metal brace and connect it to the motherboard (SATA1/SATA POWER). Then, plug the other end of the cable into the SATA HDD.
4. Replace the rear cover and tighten the screws.

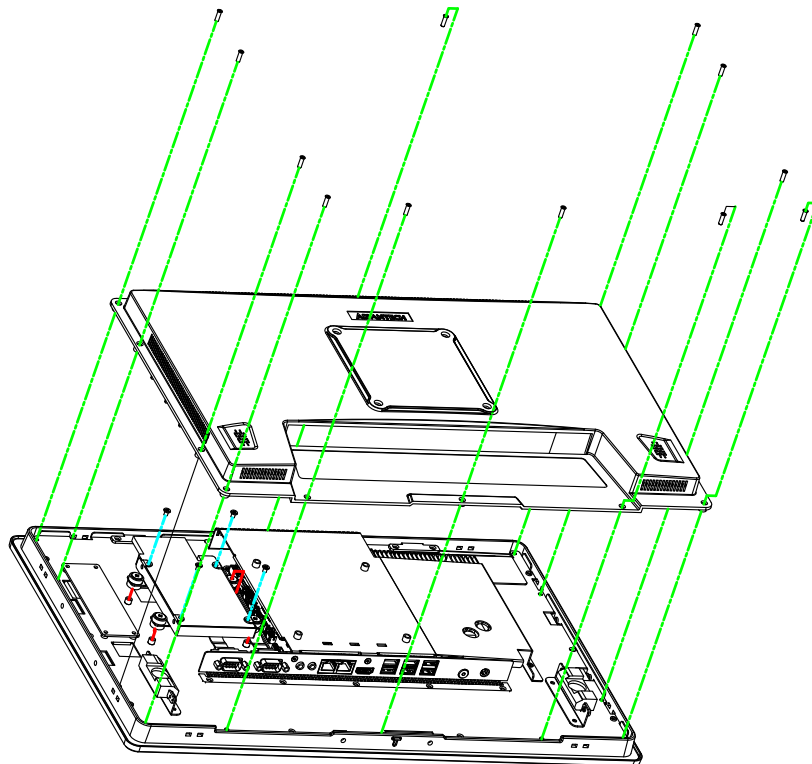

Figure 3.1 Primary 2.5" HDD Installation

3.3 mSATA Card Installation

1. Remove the 10 screws on the rear cover.
2. Remove the 6 screws on the reinforced board.

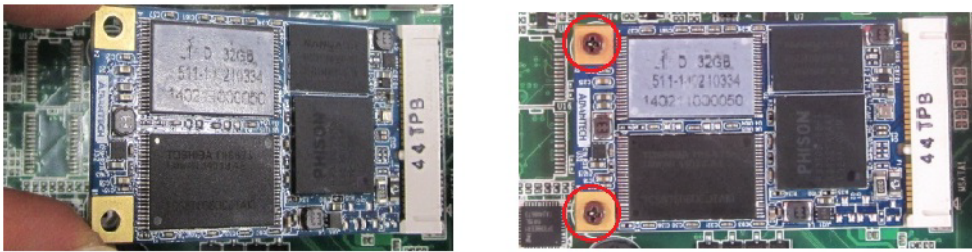
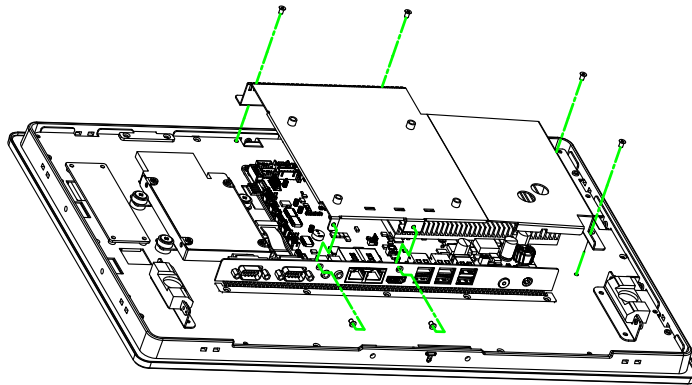
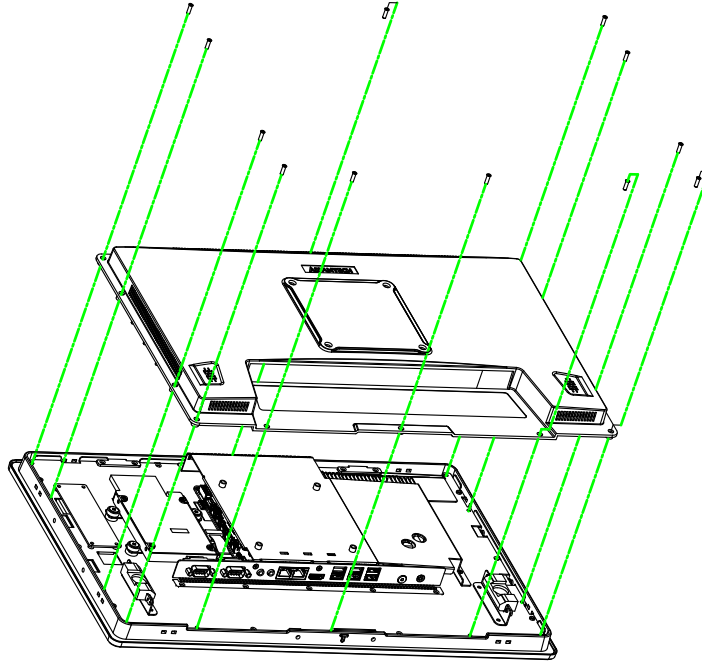

Figure 3.2 mSATA Card Installation

3.4 WLAN Installation

Reserve two locations for the external antenna; one should be an I/O port, and the other on the rear cover. However, customers can determine the specific location according to their requirements.

1. Remove the 10 screws on the rear cover.



2. Remove the 6 screws on the reinforced board.
3. Coaxial cable (Advantech P/N: 1750006682-01)



4. Connect the coaxial cable to "ANT1" on the WLAN card.



5. Install the WLAN card on the bottom side of the motherboard.

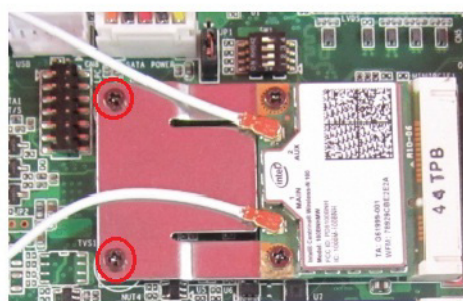
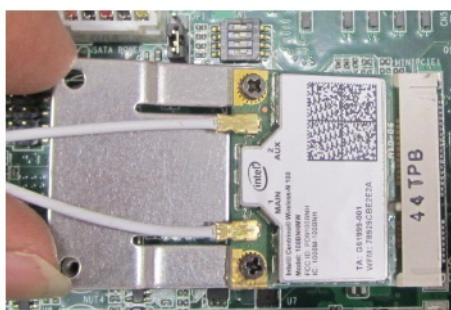

6. The wireless antenna cables should be routed as shown below.

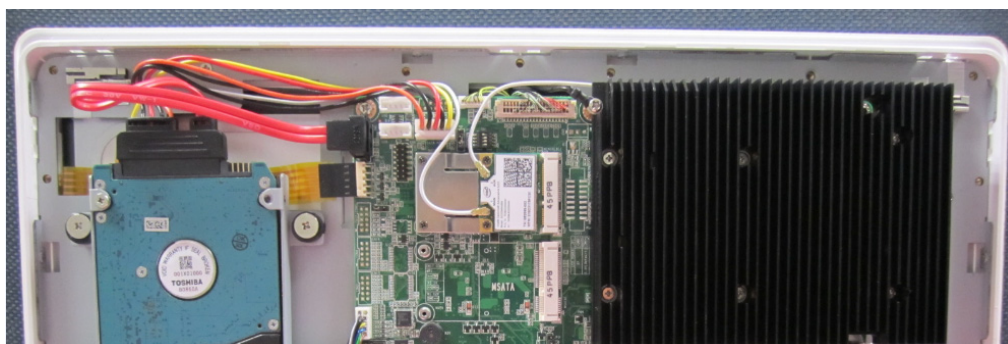

Chapter 4

Jumper Settings and Connectors

This chapter provides instructions on setting jumpers and connecting peripherals, switches, and indicators. Please read all safety precautions before beginning the installation.

- Jumpers and Connectors
- CMOS Clear for External RTC (JP3)
- COM Port Interface
- Watchdog Timer Configuration

4.1 Jumpers and Connectors

4.1.1 Setting Jumpers

UTC-318 can be configured according to the application by setting jumpers. A jumper is the simplest type of electrical switch and comprises two metal pins and a small metal clip (often protected by a plastic cover) that slides over and connects the pins. To close a jumper, connect the pins with the clip. To open a jumper, remove the clip. Some jumpers may have three pins, labeled 1, 2, and 3. For such jumpers, connect either Pins 1 and 2 or Pins 2 and 3.

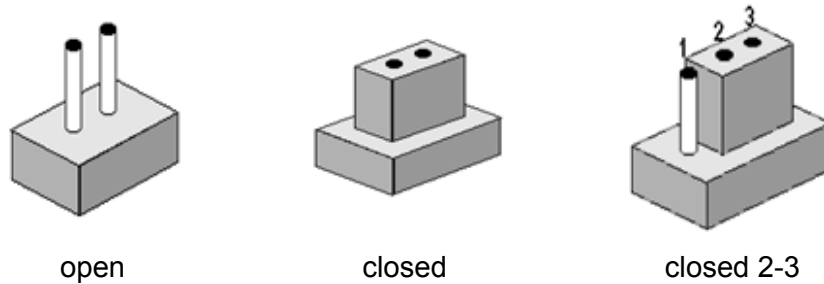

The jumper settings are schematically depicted below.

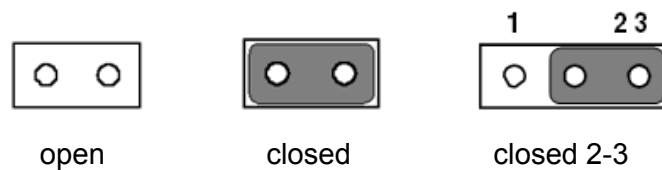

A pair of needle-nose pliers may be necessary when working with jumpers. For advice regarding the optimum hardware configuration for a specific application, please contact your local distributor or sales representative before making any changes.

4.1.2 Jumpers and Connectors

The UTC-318 motherboard features several jumpers and connectors that enable users to configure the system according to the applications. The function of every motherboard jumper is listed in the table below.

Table 4.1: Jumper and Connector Functions

Label	Function
CN1	Back_Light
CN3	Internal USB
CN4	LVDS
CN6	SATA
CN7	SATA Power
CN8	Internal USB
CN9	Touch
CN13	DDR3L SODIMM
MINIPCE1	MiniPCle
MSATA1	mSATA
CN16	COM2
CN18	COM1
CN22	Speaker
CN21	Power switch
CN23	LAN1/LAN2
CN24	External USB
CN25	External USB
CN26	External USB
CN27	Line-out
CN28	Mic-in
CN30	HDMI
CN31	DC-in
SW2 BUTTON	Power button

4.1.3 Jumper and Connector Locations

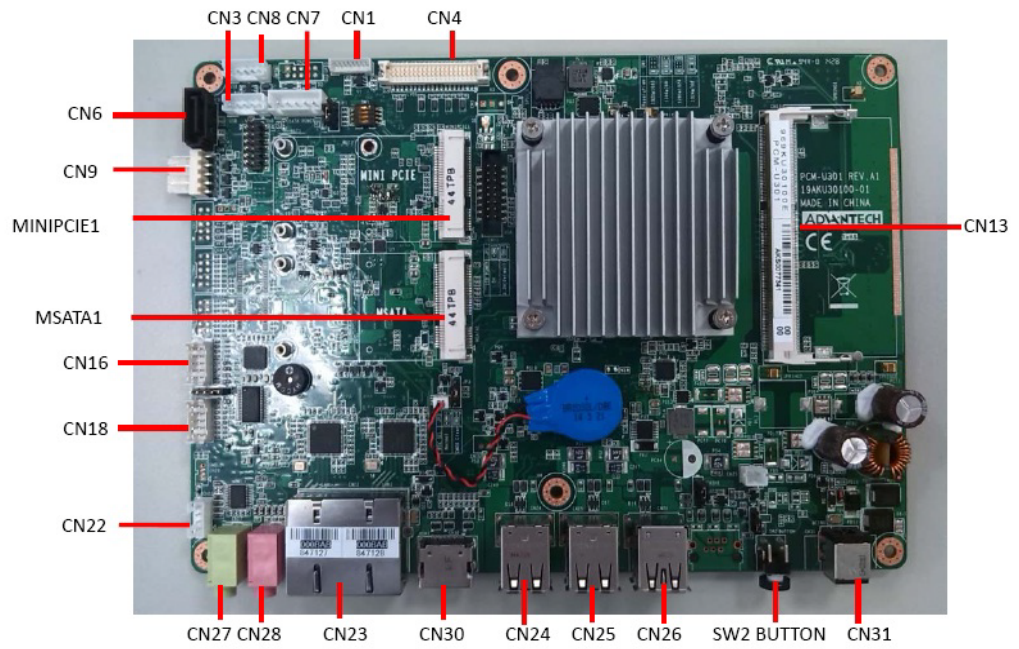

Figure 4.1 Jumper and Connector Locations

4.2 Jumpers

4.2.1 Jumper List

Table 4.2: Jumper List

JP1	LCD Power
JP3	Clear CMOS
JP4	AT/ATX Power SEL
CN17	COM1 Ring

4.2.2 Jumper Settings

Table 4.3: JP1: LCD Power

Part Number	1653003100
Footprint	HD_3x1P_100_D
Description	Pin Header 3x1P 2.54 mm 180D(M) DIP 205-1x3GS
Setting	Function
(1-2)	5 V
(2-3)*	3.3 V

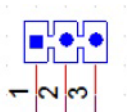

Table 4.4: JP3: Clear CMOS

Part Number	1653004101
Footprint	HD_4x1P_79_D
Description	Pin Header 4x1P 2.0 mm 180D(M) DIP 21N12050
Setting	Function
(2-3)*	Normal
(3-4)	Clear CMOS

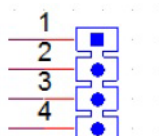

Table 4.5: JP4: AT/ATX Power SEL

Part Number	1653003101
Footprint	HD_3x1P_79_D
Description	Pin Header 3*1P 180D(M) 2.0 mm DIP SQUARE W/O Pb
Setting	Function
(1-2)	AT
(2-3)*	ATX

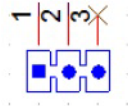
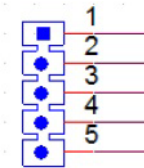

Table 4.6: CN17: COM1 Ring

Part Number	1653005101
Footprint	HD_5x1P_79_D
Description	Pine Header 5x1P 2.0 mm 180D(M) DIP 1140-000-05SN
Setting	Function
(1-2)	Ring
(3-4)*	COM1 RI output +5 V
(4-5)*	COM1 RI output +12 V



Appendix **A**

I/O Pin Assignments

A.1 PIN Assignments

Table A.1: CN1: Backlight

Part Number	1655004512-01
Footprint	WF_8P_49_BOX_D
Description	Wafer Box 8P 1.25 mm 180D(M) DIP A1251WV0-8P
Pin	Pin Name
1	+12 V_INVERTER
2	+12 V_INVERTER
3	GND
4	GND
5	BKLT_EN
6	BRIGHT1
7	+12V_INVERTER
8	GND

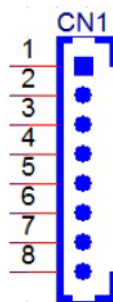

Table A.2: CN3: Internal USB

Part Number	1655000453
Footprint	WHL5V-2M-24W1140
Description	Wafer Box 2.0 mm 5P 180D(M) DIP WO/Pb JIH VEI
Pin	Pin Name
1	+5 V
2	D-
3	D+
4	GND
5	GND

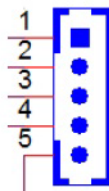

Table A.3: CN4: LVDS	
Part Number	1653920200
Footprint	SPH20X2
Description	B/B Conn. 40P 1.25 mm 90D SMD DF13-40DP-1.25V(91)
Pin	Pin Name
1	+3.3 V or +5 V
2	+3.3 V or +5 V -
3	GND
4	GND
5	+3.3 V or +5 V
6	+3.3 V or +5 V
7	LVDS0_D0-
8	LVDS1_D0-
9	LVDS0_D0+
10	LVDS1_D0+
11	GND
12	GND-
13	LVDS0_D1-
14	LVDS1_D1-
15	LVDS0_D1+
16	LVDS1_D1+
17	GND
18	GND
19	LVDS0_D2-
20	LVDS1_D2-
21	LVDS0_D2+
22	LVDS1_D2+-
23	GND
24	GND
25	LVDS0_CLK-
26	LVDS1_CLK-
27	LVDS0_CLK+
28	LVDS1_CLK+
29	GND
30	GND
31	LVDS0_DDC_SC
32	LVDS0_DDC_SD
33	GND
34	GND
35	LVDS0_D3-
36	LVDS1_D3-
37	LVDS0_D3+
38	LVDS1_D3+
39	+3.3 V or +5 V
40	+3.3 V or +5 V

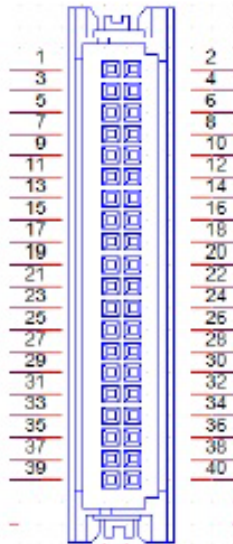

Table A.4: CN6: SATA

Part Number	1654004659
Footprint	WF_5P_98_BOX_D
Description	Wafer Box 5P 2.5 mm 180D(M) DIP 2503-WS-5
Pin	Pin Name
1	GND
2	TX+
3	TX-
4	GND
5	RX+
6	RX-
7	GND

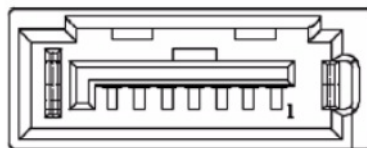
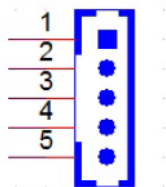

Table A.5: CN7: SATA Power

Part Number	1659254005
Footprint	SATA_7P_WATM-07DBN4A3B8UW_D
Description	Serial ATA 7P 1.27 mm 180D(M) DIP WATM-07DBN4A3B8
Pin	Pin Name
1	+3.3 V
2	GND
3	+5 V
4	GND
5	+12 V

**Table A.6: CN8: Internal USB**

Part Number	1655000453
Footprint	WHL5V-2M-24W1140
Description	Wafer Box 2.0 mm 5P 180D(M) DIP WO/Pb JIH VEI
Pin	Pin Name
1	+5 V
2	D-
3	D+
4	GND
5	GND

**Table A.7: CN9: Touch**

Part Number	1655005110
Footprint	WF_5P_100_RA_D
Description	Wafer 5P 2.54 mm 90D(M) DIP 2542-WR-5
Pin	Pin Name
1	Y+
2	Y-
3	SENSE
4	X+
5	X-

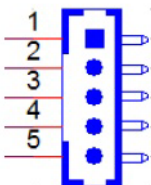

Table A.8: CN13: DDR3L SODIMM

Part Number	1651002087-11
Footprint	DDR3_204P_AS0A626-N2S6-7H
Description	DDR3 SODIMM H= 5.2 mm STD 204P SMD AS0A626-H2S6-7H
Pin	Pin Name
1	VREF_DQ
2	GND
3	GND
4	DQ4
5	DQ0
6	DQ5
7	DQ1
8	GND
9	GND
10	
11	GND
12	GND
13	DQ4
14	DQ0
15	DQ5
16	DQ1
17	GND
18	GND
19	GND
20	GND
21	DQ4
22	DQ0
23	DQ5
24	DQ1
25	GND
26	GND
27	
28	GND
29	GND
30	DQ4
31	DQ0
32	DQ5
33	DQ1
34	GND
35	GND

Table A.9: MINI PCIE1: Mini PCIe	
Part Number	1654002538
Footprint	FOX_AS0B226-S68K7F
Description	Mini PCIe 52P 6.8 mm 90D SMD AS0B226-S68Q-7H
Pin	Pin Name
1	MPCIE1_WAKE#
2	+3.3 VSB
3	NC
4	GND
5	NC
6	NC
7	MPCIE_CLKREQ#
8	NC
9	GND
10	NC
11	CLK_MINI_PCIE-
12	NC
13	CLK_MINI_PCI+
14	NC
15	GND
16	NC
17	NC
18	GND
19	NC
20	MPCIE1_DISABLE#
21	GND
22	PLTRST#
23	PCIE_RX-
24	+3.3 VSB
25	PCIE_RX+
26	GND
27	GND
28	+1.5 V
29	GND
30	SMB_CLK_MPCIE1
31	PCIE_TX-
32	SMB_DAT_MPCIE1
33	PCIE_TX+
34	GND
35	GND
36	USB_D-
37	GND
38	USB_D+
39	+3.3 VSB
40	GND
41	+3.3 VSB
42	NC

Table A.9: MINI PCIE1: Mini PCIe

43	NC
44	NC
45	NC
45	NC
47	NC
48	NC
49	NC
50	GND
51	NC
52	+3.3 VSB

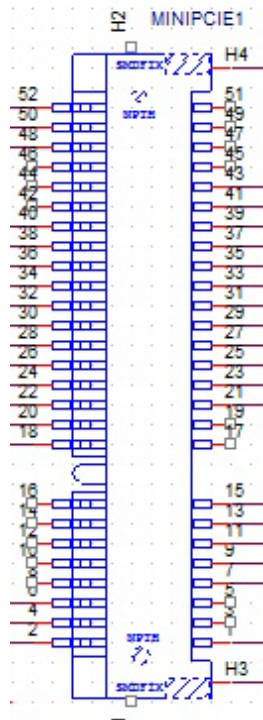

Table A.10: MSATA1: MSATA

Part Number	1654002538
Footprint	FOX_AS0B226-S68K7F
Description	Mini PCIe 52P 6.8 mm 90D SMD AS0B226-S68Q-7H
Pin	Pin Name
1	NC
2	+3.3 V
3	NC
4	NC
5	NC
6	NC
7	NC
8	NC
9	GND
10	NC
11	NC

Table A.10: MSATA1: MSATA	
12	NC
13	NC
14	NC
15	GND
16	NC
17	NC
18	GND
19	NC
20	NC
21	GND
22	NC
23	SATA1_RX+
24	+3.3 V
25	SATA1_RX-
26	GND
27	GND
28	NC
29	GND
30	NC
31	SATA1_TX-
32	NC
33	SATA1_TX+
34	GND
35	GND
36	NC
37	GND
38	NC
39	+3.3 V
40	GND
41	+3.3 V
42	NC
43	NC
44	NC
45	NC
45	NC
47	NC
48	NC
49	NC
50	GND
51	+3.3 V
52	+3.3 V

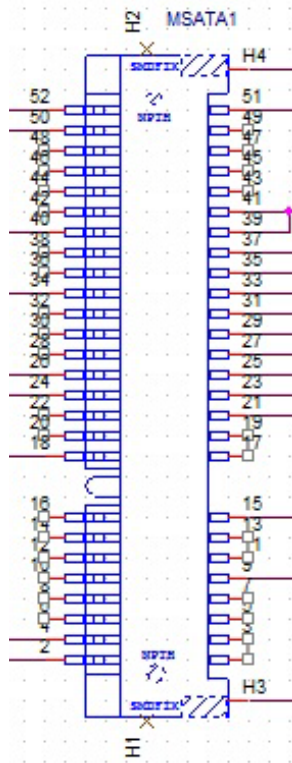
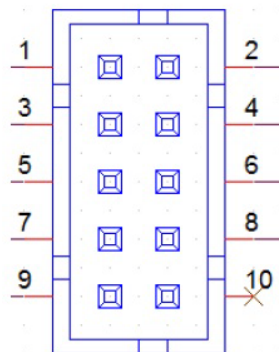

Table A.11: CN16: COM2

Part Number	1655000197
Footprint	WF_5x2P_79_BOX_D_P1R
Description	1655_WF_5x2P_79_BOX_D_P1R_0.Normal
Pin	Pin Name
1	422/485 TX-
2	422/485 TX+
3	422 RX+
4	422 RX-
5	GND
6	DSR#
7	RTS#
8	CTS#
9	RI#



UART RS485 Auto Flow Control

COM2 supports the RS485 auto-flow control function for all UARTs.

When enabling the RS485 auto-flow control function, the system automatically drive the RTS# pin automatically adopts either the “logic high” or “logic low” setting for flow control.

To enable the RS485 auto-flow control function, the parity and stop-bit setting must adhere to one of the following three configurations:

- (1) 8 data bits + 1 parity bit + 1 stop bit
- (2) 8 data bits + 1 parity bit + 2 stop bits
- (3) 8 data bits + 2 stop bits

Table A.12: CN18: COM1

Part Number	1655000197
Footprint	WF_5x2P_79_BOX_D_P1R
Description	1655_WF_5x2P_79_BOX_D_P1R_0.Normal
Pin	Pin Name
1	DCD
2	RXD
3	TXD
4	DTR#
5	GND
6	DSR#
7	RTS#
8	CTS#
9	RI#

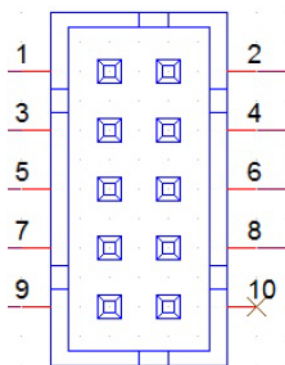

Table A.13: CN21: Power Switch

Part Number	1655302020
Footprint	WF_2P_79_BOX_R1_D
Description	Wafer Box 2P 2.0 mm 180D(M) DIP A2001WV2-2P
Pin	Pin Name
1	PSIN
2	GND

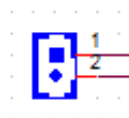

Table A.14: CN22: Speakers

Part Number	1655304020
Footprint	WF_4P_79_BOX_R1_D
Description	Wafer Box 2.0 mm 4P 180D(M) W/LOCK A2001WV2-4P
Pin	Pin Name
1	AUD_OUTA-
2	AUD_OUTA+
3	AUD_OUTB+
4	AUD_OUTB-

**Table A.15: CN23: LAN1/LAN2**

Part Number	1652003274
Footprint	RJ45_28P_RTB-19GB9J1A
Description	Phone Jack RJ45 28P DIP RTB-19GB9J1A

Table A.16: CN24: External USB

Part Number	1654009513
Footprint	USB_8P_UB1112C-8FDE-4F
Description	USB Conn. 8P 2.0 mm 90D DIP UB1112C-8FDE-4F
Pin	Pin Name
1	+5 VSB
2	D-
3	D+
4	GND
5	+5 VSB
6	D-
7	D+
8	GND

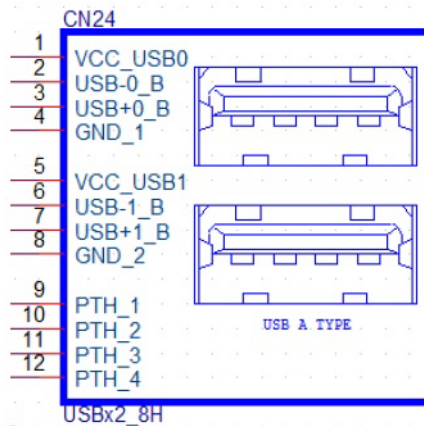
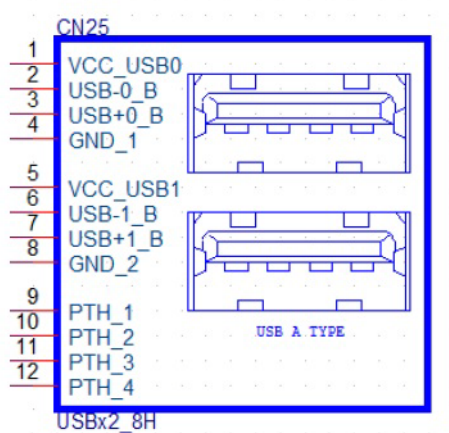

Table A.17: CN25: External USB

Part Number	1654009513
Footprint	USB_8P_UB1112C-8FDE-4F
Description	USB Conn. 8P 2.0 mm 90D DIP UB1112C-8FDE-4F
Pin	Pin Name
1	+5 VSB
2	D-
3	D+
4	GND
5	+5 VSB
6	D-
7	D+
8	GND

**Table A.18: CN26: External USB**

Part Number	1654010199
Footprint	USB_13P_UEA1112C-UHS6-4F
Description	USB Conn. 2.0+3.0 13P 90D(F) DIP UEA1112C-UHS6-4
Pin	Pin Name
1	+5VSB
2	D0-
3	D0+
4	GND
5	RX_D-
6	RX_D+
7	GND
8	TX_D-
9	TX_D+
10	+5 VSB
11	D1-
12	D1+
13	GND

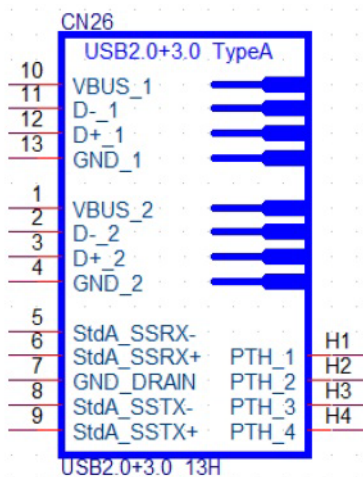

Table A.19: CN27: Line Out

Part Number	1652001586
Footprint	KUONYI_PJ-2508PC-5-L
Description	Phone Jack 5P 3.5φ 90D(F) AZALIA GREEN DIP WO/P
Pin	Pin Name
1	GND
2	OUT_L
3	JD
4	OUT_R
5	GND

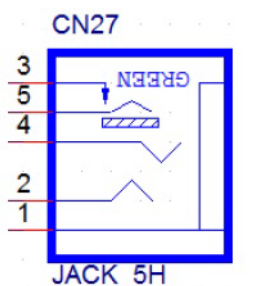

Table A.20: CN28: Mic In

Part Number	1652001584
Footprint	KUONYI_PJ-2508PA-5-L
Description	Phone Jack 5P 3.5φ 90D(F) AZALIA PINK DIP WO/Pb
Pin	Pin Name
1	GND
2	MIC_L
3	JD
4	MIC_R
5	GND

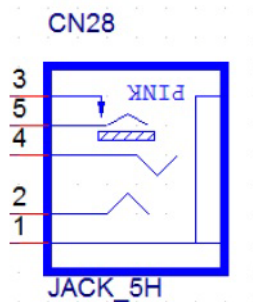

Table A.21: CN30: HDMI

Part Number	1654011175-01
Footprint	HDMI_19P_QJ51191-LFB4-7F
Description	HDMI Conn. 19P 0.5 mm 90D(F) SMD QJ51191-LFB4-7F
Pin	Pin Name
1	HDMI_TX0+
2	GND
3	HDMI_TX0-
4	HDMI_TX1+
5	GND
6	HDMI_TX1-
7	HDMI_TX2+
8	GND
9	HDMI_TX2-
10	HDMI_TX3+
11	GND
12	HDMI_TX3-
13	NC
14	NC
15	HDMI_CLK
16	HDMI_DAT
17	GND
18	+5 V
19	HDMI_DET

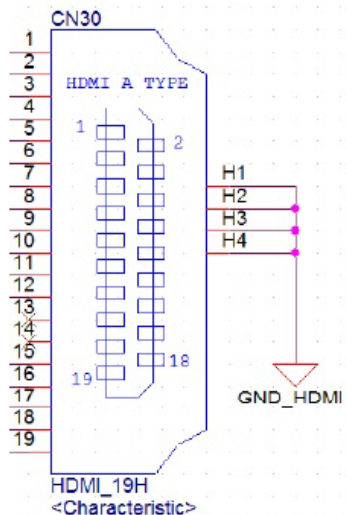

Table A.22: CN31: DC-In

Part Number	1652005624
Footprint	PJ_2P_2DC-G213B200
Description	DC Power Jack 2.5 mm 90D(M) DIP 2DC-G213B200
Pin	Pin Name
1	DC_IN
2	GND

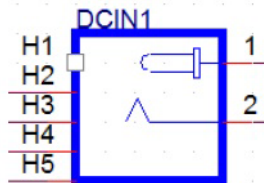
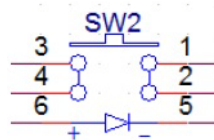

Table A.23: SW2 Button: Power Button

Part Number	1600000055
Footprint	SW_6P_TC003-N11AABRGXX-RK_D
Description	PUSH SW DIP 6P W/LED WO/Pb TC003-N11AABRGXX-RK
Pin	Pin Name
1	GND
2	GND
3	ATX_PWRBTN#
4	ATX_PWRBTN#
5	+5 V
6	GND



ADVANTECH

Enabling an Intelligent Planet

www.advantech.com

Please verify specifications before quoting. This guide is intended for reference purposes only.

All product specifications are subject to change without notice.

No part of this publication may be reproduced in any form or by any means, including electronically, by photocopying, recording, or otherwise, without the prior written permission of the publisher.

All brand and product names are trademarks or registered trademarks of their respective companies.

© Advantech Co., Ltd. 2015