

RIGHTANGLE PLUG MALE

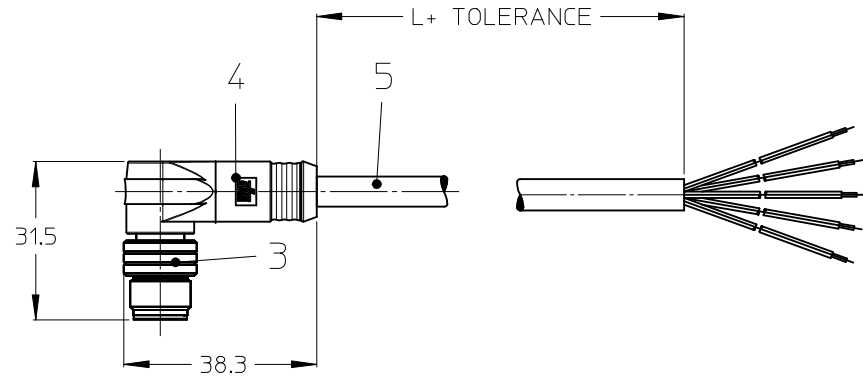
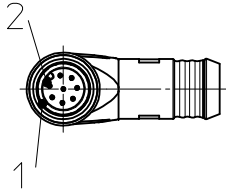

NOTES:

TEMPERATURE RANGE	SEE TABLE ON PAGE 2
CONTACT CURRENT RATING	3-5 POLES 4A 8 POLES 2A
VOLTAGE RATING	3-4 POLES 250V 5 POLES 60V 8 POLES 30V
PROTECTION CLASS	IP 67

TOLERANCES

≤ 1m	+20 / -10mm
1m - 5m	± 25mm
5m - 10m	± 30mm
> 10m	± 30mm
> 20m	± 50mm

3 WIRE	4 WIRE	5 WIRE	8 WIRE
PIN # WIRE	PIN # WIRE	PIN # WIRE	PIN # WIRE
1 BROWN 2 - 3 BLUE 4 BLACK 5 -	1 BROWN 2 WHITE 3 BLUE 4 BLACK 5 -	1 BROWN 2 WHITE 3 BLUE 4 BLACK 5 GREY	1 WHITE 2 BROWN 3 GREEN 4 YELLOW 5 GREY 6 PINK 7 BLUE 8 RED
REQUIRED TO IEC 60947-5-2		REQUIRED TO DIN 47100	

5	CABLE	SEE TABLE (PAGE 2)	---
4	OVERMOULDING	TPU	BLACK
3	MALE COUPLING NUT	BRASS	NI PLATED
2	PIN CONTACT	BRASS	GOLD PLATED
1	INSERT	PA	BLACK
ITEM	PART	MATERIAL	FINISH

ENTER DESCRIPTION EC NO: IPG2014-0812 DRWN:PMERUNKA 2012/04/24 CHKD:APOHL 2013/11/04 APPR:APOHL 2013/11/18	QUALITY SYMBOLS ▽=0 ◻=0	GENERAL TOLERANCES (UNLESS SPECIFIED) <table border="1"> <tr> <th></th> <th>mm</th> <th>INCH</th> </tr> <tr> <td>4 PLACES</td> <td>± ---</td> <td>± ---</td> </tr> <tr> <td>3 PLACES</td> <td>± ---</td> <td>± ---</td> </tr> <tr> <td>2 PLACES</td> <td>± 0.05</td> <td>± ---</td> </tr> <tr> <td>1 PLACE</td> <td>± 0.10</td> <td>± ---</td> </tr> <tr> <td>0 PLACE</td> <td>± ---</td> <td>± ---</td> </tr> </table>		mm	INCH	4 PLACES	± ---	± ---	3 PLACES	± ---	± ---	2 PLACES	± 0.05	± ---	1 PLACE	± 0.10	± ---	0 PLACE	± ---	± ---	DIMENSION STYLE MM ONLY	SCALE 1:1	DESIGN UNITS METRIC	THIRD ANGLE PROJECTION
		mm	INCH																					
4 PLACES	± ---	± ---																						
3 PLACES	± ---	± ---																						
2 PLACES	± 0.05	± ---																						
1 PLACE	± 0.10	± ---																						
0 PLACE	± ---	± ---																						
DRAFT WHERE APPLICABLE MUST REMAIN WITHIN DIMENSIONS	ANGULAR ± .5 °	DRAWN BY PMERUNKA DATE 2012/04/24	CHECKED BY RSILLER DATE 2013/01/18	APPROVED BY APOHL DATE 2013/11/18	TITLE CSE M12 XP AC MA RA XM SE UNSH	MATERIAL NO. SEE TABLE	DOCUMENT NO. SD-120065-051	SHEET NO. 1 OF 3																



NUMERICAL CODE (Available parts see table page 3 ff others on request.)

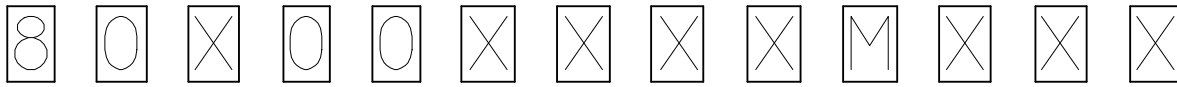

80 = M12x1
single ended

poles:
3 = 3 poles
4 = 4 poles
5 = 5 poles

header:
000 = plug female straight
001 = plug female 90° right
006 = plug male straight
007 = plug male 90° right

M = meter

length:
Example
020 = 2 m

Cable:
E02 = 0,25mm², PVC black
E03 = 0,34mm², PVC black
H08 = 0,25mm², PUR black LS0H
H09 = 0,34mm², PUR black LS0H
I03 = 0,34mm², PVC grey
K05 = 0,34mm², TPE yellow
P02 = 0,25mm², PUR/PVC black
P03 = 0,34mm², PUR/PVC black
P82 = 0,34mm², PUR black irradiated
B30 = 0,34mm², black

Special Types:

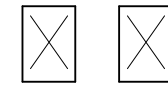

G = Brad in black
H = Sid with ID tag
1 = Stainless Steel
7 = Teflon coat

y = yellow overmoulding
empty for black

CABLE TYPE	WIRE GAUGE	CABLE JACKET	UL	CSA	static	flexing	drag chain tested	other
E02	0.25mm²	PVC black	STYLE 2464	I/II A/B 80°/300V	-30°C to +80°C 5xD	-5°C to +80°C 9xD	---	---
E03	0.34mm²	PVC black	STYLE 2464	I/II A/B 80°/300V	-30°C to +80°C 5xD	-5°C to +80°C 9xD	---	---
H08	0.25mm²	PUR black LS0H	AWM STYLE 21198/10493	APPROVED	-50°C to +80°C 5xD	-25°C to +80°C 10xD	2000000 cycles	---
H09	0.34mm²	PUR black LS0H	AWM STYLE 21198/10493	APPROVED	-50°C to +80°C 5xD	-25°C to +80°C 10xD	drag chain 60°C	---
I03	0.34mm²	PVC grey	---	---	-30°C to +70°C	-5°C to +70°C	---	---
K05	0.34mm²	TPE yellow	ITC E195601 or PLTC	AWM I/II A/B FT4 LL54185	---	---	---	CSA-US:ITC LL54185-02
P02	0.25mm²	PUR/PVC black	not applicable	not applicable	-30°C to +80°C 7xD	-5°C to +80°C 15xD	---	---
P03	0.34mm²	PUR/PVC black	not applicable	not applicable	-30°C to +80°C 7xD	-5°C to +80°C 15xD	---	---
P82	0.34mm²	irrad. PUR orange	---	---	-50°C to +105°C 5xD	-40°C to +105°C 7.5xD	---	---
B30	0.34mm²	PUR black	STYLE 21215	yes	-40°C to +90°C 5xD	-25°C to +80°C 7.5xD	---	---

ENTER DESCRIPTION EC NO: IPG2014-0812 DRWN:PMERUNKA 2012/04/24 CHKD:APOHL 2013/11/04 APPR:APOHL 2013/11/18	DESCRIPTION 1	QUALITY SYMBOLS ▽=0 ◻=0	GENERAL TOLERANCES (UNLESS SPECIFIED) mm INCH 4 PLACES ± --- ± --- 3 PLACES ± --- ± --- 2 PLACES ± 0.05 ± --- 1 PLACE ± 0.10 ± --- 0 PLACE ± --- ± --- ANGULAR ± .5 ° DRAFT WHERE APPLICABLE MUST REMAIN WITHIN DIMENSIONS	DIMENSION STYLE MM ONLY DRAWN BY PMERUNKA DATE 2012/04/24 CHECKED BY RSILLER DATE 2013/01/18 APPROVED BY APOHL DATE 2013/11/18	SCALE 1:1 DESIGN UNITS METRIC THIRD ANGLE PROJECTION	TITLE CSE M12 XP AC MA RA XM SE UNSH
		MATERIAL NO. SEE TABLE	DOCUMENT NO. SD-120065-051	SHEET NO. 2 OF 3		
		THIS DRAWING CONTAINS INFORMATION THAT IS PROPRIETARY TO MOLEX INCORPORATED AND SHOULD NOT BE USED WITHOUT WRITTEN PERMISSION				
		molex				

10 9 8 7 6 5 4 3 2 1

F

F

E

E

D

D

C

C

B

B

A

A

1200658567	803007E03M010
1200060273	803007E03M020
1200658568	803007E03M030
1200658569	803007E03M040
1200060275	803007E03M050
1200658506	803007E03M100
1200658720	803007H09M010
1200658721	803007H09M015
1200658722	803007H09M020
1200658723	803007H09M030
1200658724	803007H09M040
1200658725	803007H09M050
1200658726	803007H09M100
1200658596	803007I03M010
1200658597	803007I03M040
1200658598	803007I03M100
1200651501	803007K05M020
1200651502	803007K05M040
1200651503	803007K05M050
1200651504	803007K05M060
1200651505	803007K05M100
1200658615	803007P03M010
1200060288	803007P03M020
1200060289	803007P03M030
1200658614	803007P03M040
1200062055	803007P03M050
1200658618	803007P03M100
1200060293	803007S20M050
1200658464	803007S20M0501
1200062638	804007E03M006
1200060582	804007E03M010
1200062680	804007E03M0101
1200061975	804007E03M020
1200062681	804007E03M0201
1200060583	804007E03M030



1200658572	804007E03M040
1200060584	804007E03M050
1200062682	804007E03M0501
1200658515	804007E03M0501H
1200062238	804007E03M100
1200063575	804007E03M1001
1200658516	804007E03M1001H
1200063576	804007E03M1501
1200064280	804007E03M200
1200063656	804007E03M2001
1200658235	804007E03M2501
1200064175	804007E03M4001
1200063831	804007E52M100
1200658734	804007H09M010
1200658735	804007H09M015
1200658736	804007H09M020
1200658737	804007H09M030
1200658738	804007H09M040
1200658739	804007H09M050
1200658740	804007H09M100
1200060587	804007H69M020
1200658602	804007I03M010
1200060589	804007I03M020
1200658603	804007I03M030
1200658604	804007I03M040
1200651686	804007K03M005
1200651687	804007K03M020
1200651688	804007K03M050
1200651689	804007K03M060
1200652026	804007K03M100
1200651690	804007K05M006
1200651691	804007K05M020
1200651692	804007K05M040
1200651693	804007K05M050
1200651694	804007K05M060

1200651695	804007K05M100
1200010093	804007P03M003W
1200064178	804007P03M005
1200010094	804007P03M006W
1200061764	804007P03M010
1200010095	804007P03M010W
1200010096	804007P03M015W
1200060592	804007P03M020
1200064394	804007P03M020G
1200010097	804007P03M020W
1200060593	804007P03M030
1200010098	804007P03M030W
1200652145	804007P03M040
1200060594	804007P03M050
1200010099	804007P03M050W
1200652146	804007P03M060
1200060595	804007P03M100
1200010102	804007P03M200W
1200010796	804007P03M500W
1200658005	804007P82M010
1200655015	804007P82M050
1200655016	804007P82M100
1200655017	804007P82M200
1200062086	804007S20M050
1200658964	804007S20M0501
1200060599	804007S20M100
1200658963	804007S20M1001
1200010098	804007P03M030W
1200010099	804007P03M050W
1200010102	804007P03M200W

1200010796	804007P03M500W
1200658964	804007S20M0501
1200658963	804007S20M1001
1200658096	805007E03M020
1200062929	805007E03M050
1200062498	805007E03M100
1200658748	805007H09M010
1200658749	805007H09M015
1200658750	805007H09M020
1200658751	805007H09M030
1200658752	805007H09M040
1200658753	805007H09M050
1200658754	805007H09M100
1200658327	805007I03M015
1200652159	805007K03M020
1200652160	805007K03M040
1200652161	805007K03M050
1200652162	805007K03M060
1200652163	805007K03M100
1200060695	805007P03M010
1200060696	805007P03M015
1200060697	805007P03M020
1200060699	805007P03M040
1200658186	805007P03M050
1200652149	805007P03M060
1200655006	805007P03M100
1200658521	805007P12M006
1200062304	805007P12M015
1200658522	805007P12M020

1200658549	808007E02M020
1200658580	808007E03M010
1200658581	808007E03M030
1200658582	808007E03M040
1200658583	808007E03M050
1200658584	808007E03M100
1200658755	808007H08M010
1200658756	808007H08M015
1200658757	808007H08M020
1200658758	808007H08M030
1200658759	808007H08M040
1200658760	808007H08M050
1200658761	808007H08M100
1200658695	808007I03M010
1200658696	808007I03M020
1200658697	808007I03M030
1200658698	808007I03M040
1200658699	808007I03M050
1200658700	808007I03M100
1200658626	808007P02M010
1200651800	808007P02M020
1200658628	808007P02M030
1200658629	808007P02M040
1200658258	808007P02M050
1200658259	808007P02M100
1200655109	80C007H45M020
1200659081	804007E03M050Y

1200652283	803007B30M010
1200652284	803007B30M020
1200652285	803007B30M050
1200652286	803007B30M100
1200652287	804007B30M010
1200652288	804007B30M020
1200652289	804007B30M050
1200652290	804007B30M100
1200652291	805007B30M010
1200652292	805007B30M020
1200652293	805007B30M050
1200652294	805007B30M100

ENTER DESCRIPTION EC NO: IPG2014-0812 DRWN: PMERUNKA 2012/04/24 CHKD: APOHL 2013/11/04 APPR: APOHL 2013/11/18 1	QUALITY SYMBOLS  = 0  = 0	GENERAL TOLERANCES (UNLESS SPECIFIED)		DIMENSION STYLE MM ONLY		SCALE 1:1	DESIGN UNITS METRIC	 THIRD ANGLE PROJECTION		
		4 PLACES ± --- ± --- 3 PLACES ± --- ± --- 2 PLACES ± 0.05 ± --- 1 PLACE ± 0.10 ± --- 0 PLACE ± --- ± ---	mm INCH ± --- ± --- ± 0.05 ± --- ± 0.10 ± --- ± --- ± ---	DRAWN BY PMERUNKA	DATE 2012/04/24	TITLE CSE M12 XP AC MA RA XM SE UNSH				
		ANGULAR ± .5 °		CHECKED BY RSILLER	DATE 2013/01/18	DOCUMENT NO. SD-120065-051				
		DRAFT WHERE APPLICABLE MUST REMAIN WITHIN DIMENSIONS		APPROVED BY APOHL	DATE 2013/11/18	SHEET NO. 3 OF 3				
		MATERIAL NO. SEE TABLE		THIS DRAWING CONTAINS INFORMATION THAT IS PROPRIETARY TO MOLEX INCORPORATED AND SHOULD NOT BE USED WITHOUT WRITTEN PERMISSION						

9 8 7 6 5 4 3 2 1