



Intesis[®]
BY HMS NETWORKS

Gateways for building
automation and HVAC control

Connecting
sustainable buildings



Intesis connecting buildings

Intesis gateways for building automation cover all relevant standards and technologies, and includes the market's most comprehensive portfolio for HVAC integration with solutions for all major AC-brands.

Robust, reliable and easy to configure, the Intesis product family is widely used for system integration. Users benefit from efficient commissioning and uninterrupted operation.



Intesis by HMS Networks

Intesis is part of HMS Networks, market leader in solutions for industrial communication and the Industrial Internet of Things, IIoT. Intesis is the HMS' main brand for Building Automation products and solutions. Other markets from HMS are Manufacturing, Power, Energy, Transportation, Infrastructure and Logistics.

About HMS Networks

With millions of installed products worldwide, HMS Networks is the leading supplier of solutions for Industrial ICT (Information & Communication Technology). We enable valuable data and insights from industrial equipment, allowing our customers to increase productivity and sustainability.

- Employees: > 750
- Locations: in 17 countries
- Distributors: > 50 countries
- Brands: Anybus, Ewon, Intesis, Ixxat
- Customers: Device manufacturers, machine builders, system integrators, end users
- Year founded: 1988



High quality standards

Intesis products are subject to extensive testing and certification processes to ensure the highest quality standards. Also, additional tests are implemented for specific markets.

Global coverage

In addition to rigorous internal quality tests, Intesis products are also certified by independent testing labs to fulfill national legal requirements on different markets.

100% tested

Every product is tested on premises to ensure the highest quality standards.

Protocol certifications

All implementations of standard protocols in Intesis products are performed rigorously according to each protocol specification. Full interoperability is then ensured thanks to testing and certification by external accredited laboratories.

UL listed

Intesis products contain UL marked components and the production line is subject to periodic UL audits. It is with pride that we put the UL mark on all main Intesis products.



No matter what building automation protocol or AC brand,

Protocol Translators

BACnet, KNX, Modbus, DALI, M-Bus, ASCII, PROFINET, LonWorks, OCPP, EtherNet/IP — are all supported by Intesis Protocol Translators. With cutting edge technology built on a reliable platform, integration solutions are offered for all your needs.



Air conditioning interfaces

Developed with the support and collaboration of the air conditioning manufacturers, Intesis AC Interfaces enable high quality integration of climate systems into BACnet, KNX, Modbus, and 2,4 GHz wireless installations.



Cloud solutions

Intesis long experience of Building Automation protocols and communication solutions for HVAC integration brought to the cloud for straight-forward remote device management.



Intesis has the solutions for every project

Intesis MAPS – the configuration tool for Intesis products

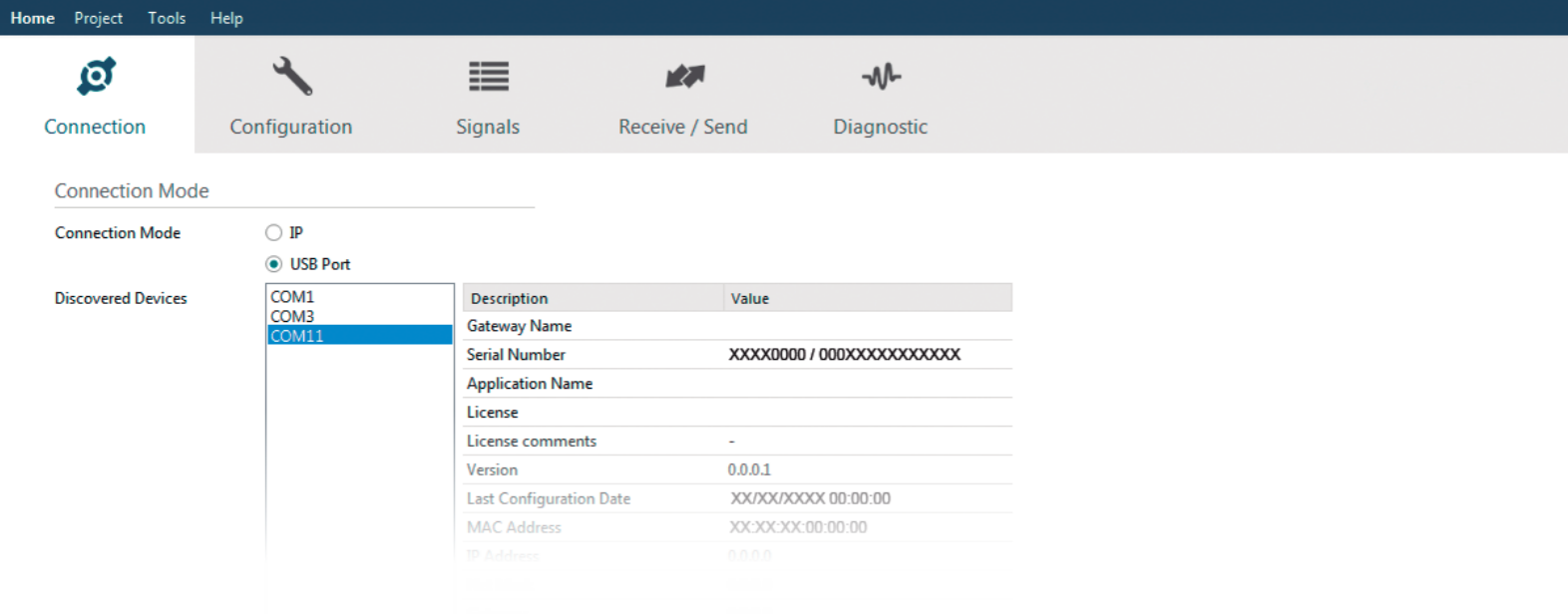

Intesis MAPS

Is an intuitive configuration tool for all Intesis gateways that helps reducing commissioning time.

Intesis MAPS enables easy configuration offering a simple and consistent way to program all gateways. Upon launching Intesis MAPS, the user selects the right template for the application they need and the configuration procedure can start.

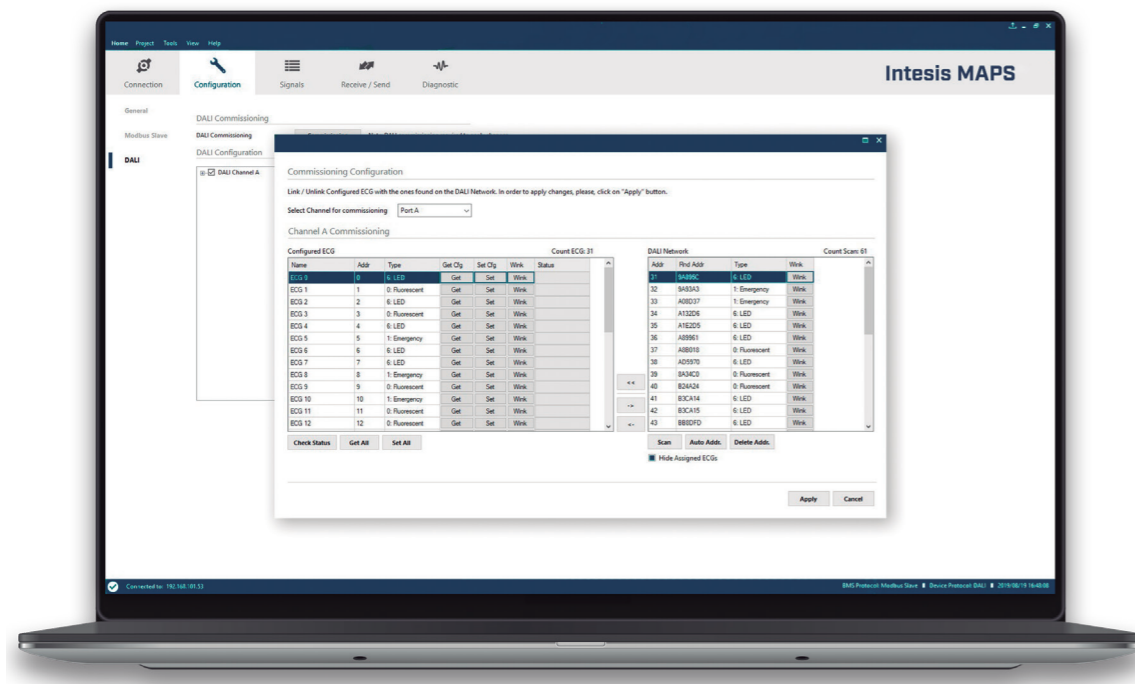

Multi Addressing Point Solution



Project templates

For every gateway there is a template providing a step by step setup guide for both protocols in the gateway.



Product templates

Product templates are provided for automatic import of all device data, removing the need for manual work.



Device scan

By using the scanning functionality, users can find devices in the field and import all their data automatically.



Data conversion

Data can be transformed into the desired format, e.g., adjusting offset, scaling or converting from degrees Celsius to Fahrenheit.



Diagnostics

Problems and errors can be detected and solved with Intesis MAPS diagnostics.



Secure and safe configuration

MAPS configuration projects are protected by passwords to prevent unauthorized manipulation of projects and installations.



Recovery

Users can save the gateway configuration project to file for e.g., recovery purposes or in case of gateway replacement.



Update information

The tool informs whenever there is a new software version available for the gateway or Intesis MAPS itself.

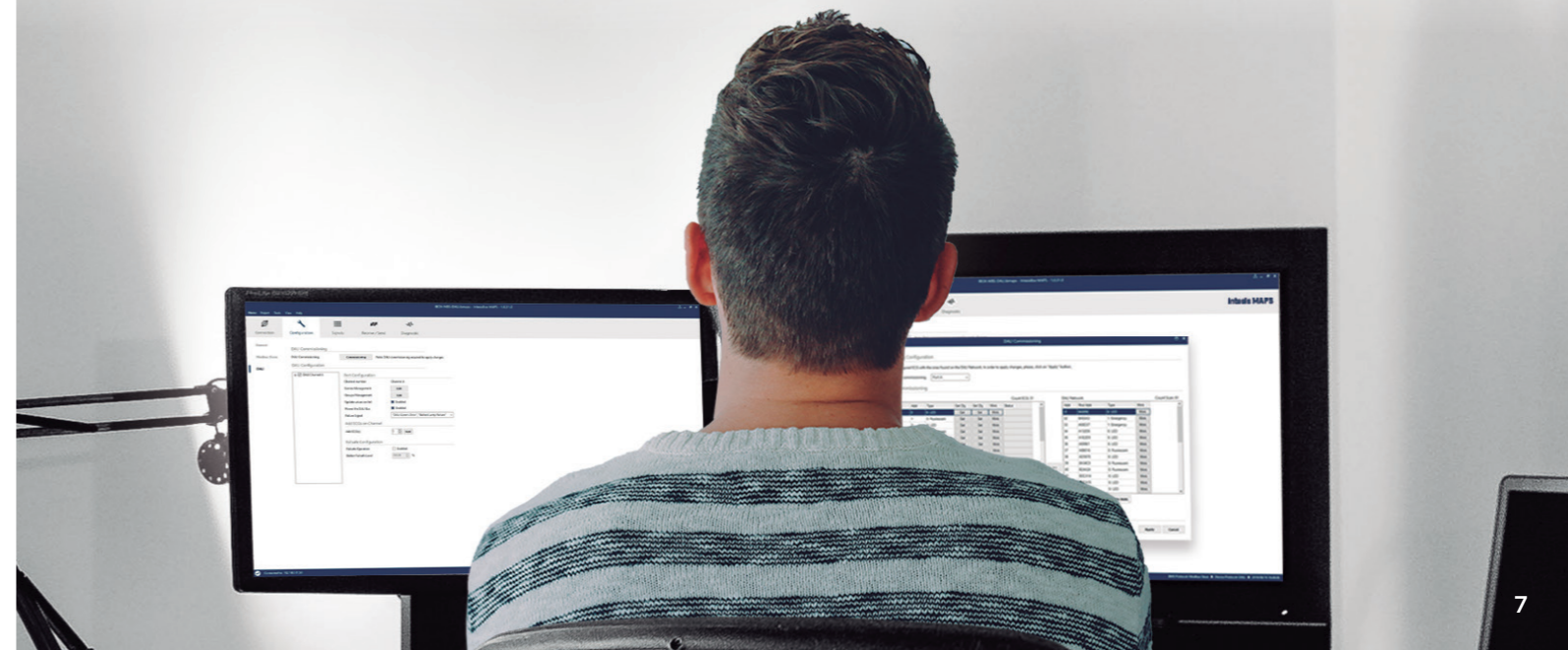

Be prepared for the integration process

Get ready to start your project even if you are not off-site

Intesis MAPS offers you the possibility of starting your projects even without the Intesis device. Simply start creating your configuration file from the field devices' manual and/or the BMS or SCADA engineer information.

Get everything ready before commissioning

Check your configuration, simulate communications, use our templates, consult our manuals, attend our webinars and get the most of our team experience in a powerful tool. Everything in its right place for a smooth commissioning process.

Template functionality

Thanks to our template functionality you can import already existing templates from third party devices* and include them in your project with a simple click of the mouse. Moreover, you can create your own templates and use them in any of your projects.

* Requires Internet connection.

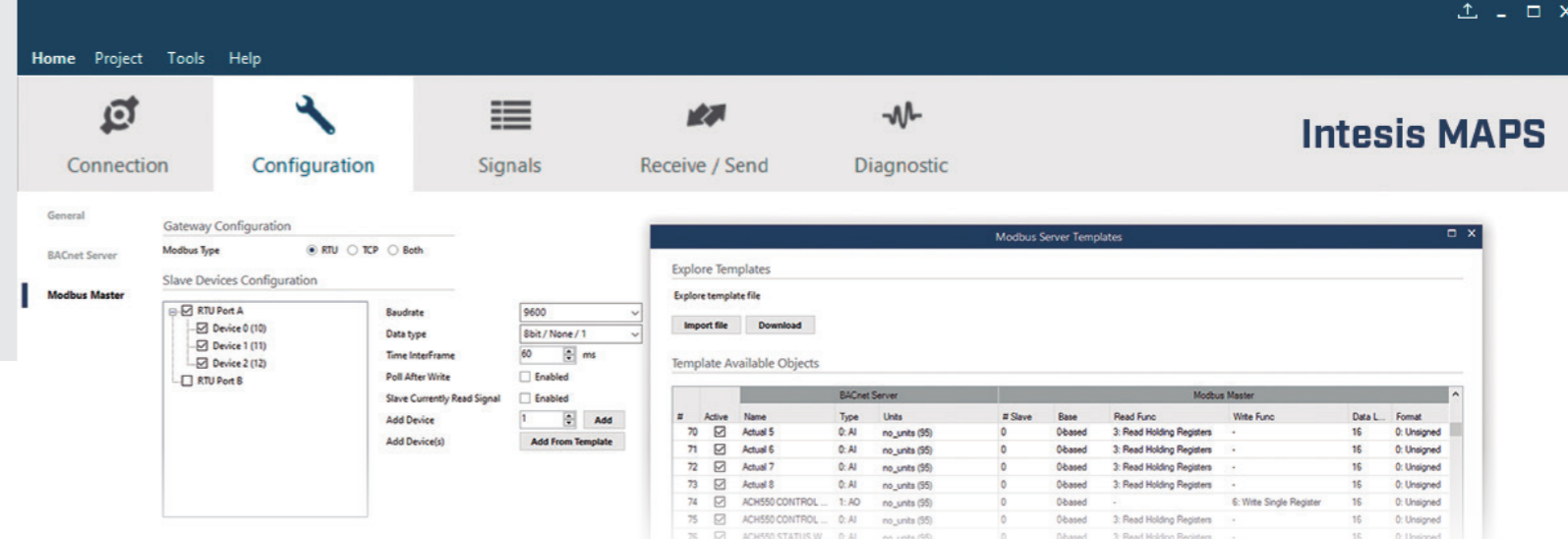

Fast, save and secure commissioning and troubleshooting

Even if you are not off-site, remote connections are available to the gateway through IP*, which ensures the possibility of testing the project during the commissioning stage. You can also troubleshoot any possible issue you might face from your office.

Save money and time with less travelling

A remote connection drastically reduces the need for travelling since commissioning or troubleshooting can be done from anywhere.

With four simple steps you will be ready to go:

- 1** Create your configuration project
- 2** Enable communications
- 3** Download the configuration
- 4** Test and/or troubleshoot

*Check with your IT department for more information about external communication configurations.

Perform the commissioning and troubleshooting anywhere

Protocol Translators

When choosing an Intesis Protocol Translator, you can be sure that you get a ready-to-use product which easily solves the complex task of integrating between building automation protocols.



ASCII

BACnet™

DALI 2

EtherNet/IP™

KNX

LonWorks

M-Bus

Modbus

OCPP

PROFI NET®

Protocol Translators with the latest technology

Intesis Protocol Translators include the most recent and modern technology, assembled in user-friendly products to facilitate installation, configuration and deployment.



LED indicator matrix

Multiple LED indicators confirm that all protocols are communicating properly or indicate if there is a communication issue.



IP/USB console

Direct and safe access to the configuration via USB or the Ethernet port.



USB host

Configuration can be performed with the USB host port, from downloading projects or generating log files to updating the firmware.



Multiple ports

With multiple ports for the different physical layers (cable/network types), all common connectivity requirements are met.



Design for DIN-rail mounting

Using just five DIN-Rail modules, it is easy to fit Intesis Protocol Translators into cabinets.



Low power

The Protocol Translators are designed for low power consumption for energy efficient operation on-site.



Intesis MAPS Configuration

Powerful configuration of all Intesis Protocol Translators for a fast and straight-forward commissioning.

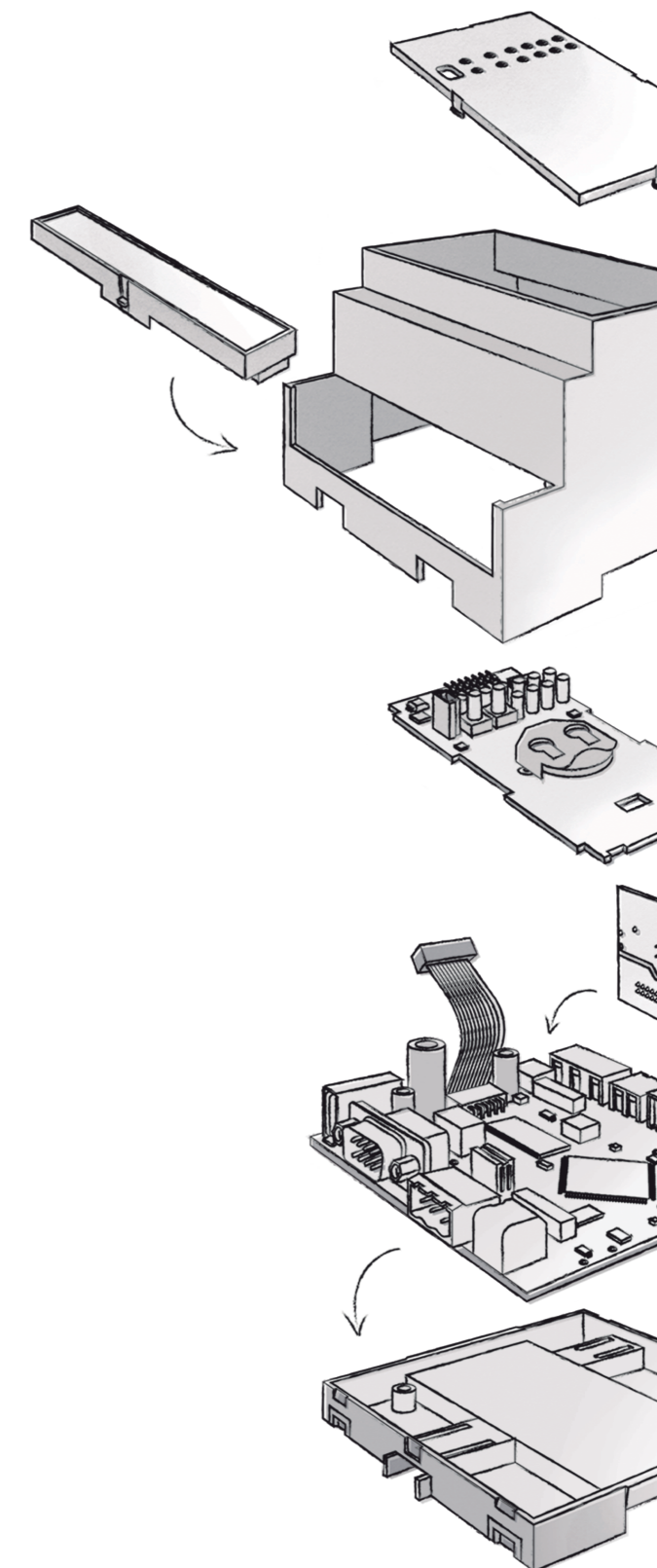

Protocol conversion in Building Automation

NEW 700 Series Intesis platforms for multi-protocol selection

700 Series is the new platform concept for Intesis Protocol Translators. This concept enables interfaces for multiple Building Automation protocols in the same hardware so, the user can pair the combination using Intesis MAPS. The process is called late configuration.

Benefits

- Reduced number of references to stock, optimizing distributor's lead times.
- Late configuration.
- Change applications quickly with our configuration tool Intesis MAPS.
- Diagnostic and troubleshooting tools available.
- Minimize technical service requests.

Product features



Stock-Friendly

Multiple protocol combinations for each hardware.



Versatility

Flexible and agile protocol translation.



User-friendly configuration

Easy to set up with Intesis MAPS, our user-friendly configuration tool.



High capacity

Up to 3000 data points of capacity to best match your needs.



Certification

International and local certifications. Ready to be sold worldwide



Available applications

Adapt your Protocol Translator to each project needs

Having different protocols available on the same hardware, enable multiple integration possibilities. Each one of the combinations is defined as an application.

Intesis MAPS, the configuration tool for Protocol Translators, is the instrument to select the correct application to match your project's needs. Is an easy process you don't need to plan in advance.



700series for Protocol Translators

IN700485*0000**

Intesis Protocol Translator with Serial and IP support - 100, 250, 600, 1200 & 3000 Points

IN701KNX*0000**

Intesis Protocol Translator with KNX, Serial and IP support - 100, 250, 600, 1200 & 3000 Points

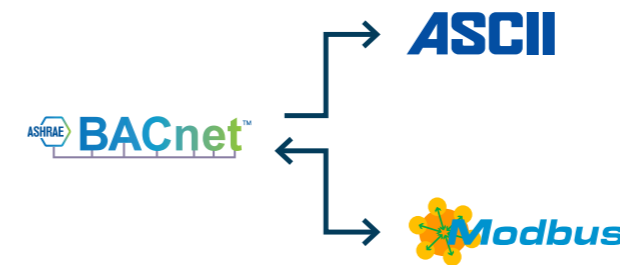





ASCII Protocol Translators

General features for ASCII

Supervision and control of BACnet or KNX devices can be done from an ASCII-based control system using simple ASCII messages over serial (EIA232, EIA485) or TCP/IP interfaces.

- Both ASCII Serial and IP supported
- Custom string signals
- Custom string commands
- Easy integration to any BMS











Application	Order Code	Point Versions
 BACnet Client to ASCII Server	IN700485***0000	100, 250, 600, 1200 & 3000 P.V. 
 KNX to ASCII Server	IN701KNX***0000	100, 250, 600, 1200 & 3000 P.V. 

BACnet Protocol Translators

General features for BACnet

Intesis Protocol Translators for BACnet perform as a BACnet/IP Server or BACnet MS/TP slave, allowing BACnet controllers to send subscription requests (COV) to read or write its internal communication objects.

- BTL certified
- BACnet/IP and MS/TP
- BBMD and foreign Device
- Notification Classes







Application	Order Code	P.V. - Point Versions D.V. - Device Versions
 KNX to BACnet Server	IN701KNX***0000	100, 250, 600, 1200 & 3000 P.V. 
 LonWorks to BACnet Server	INBACLON***0000	100, 250, 600, 1200 & 3000 P.V.
 Modbus Client to BACnet Server	IN700485***0000	100, 250, 600, 1200 & 3000 P.V. 
 DALI to BACnet Server	INBACDAL***0200	64 & 128 D.V.
 M-Bus to BACnet	INBACMEB***0000	10, 20, 60 & 120 D.V.
 BACnet MS/TP to BACnet/IP Router	INBACRTR0320000	32 D.V.
 BACnet - PROFINET Server	INBACPRT1K20000	1200 P.V.
 BACnet - EtherNet/IP Server	INBACEIP1K20000	1200 P.V.

KNX Protocol Translators

General features for KNX

A Protocol Translator with KNX connects directly to the KNX TP-1 bus carrying the same configuration and operational characteristics as any other KNX device.

- Standard KNX Datapoint Types
- Extended group addresses
- Sending and listening addresses
- Ri flag: Read on initialization flag









Application	Order Code	P.V. - Point Versions D.V. - Device Versions
 BACnet Client to KNX	IN701KNX***0000	100, 250, 600, 1200 & 3000 P.V. 
 Modbus Client to KNX Modbus RTU to KNX	IN701KNX***0000 INKNXMBM1000200	100, 250, 600, 1200 & 3000 P.V.  100 P.V. 
 DALI to KNX	INKNXDAL0640200	64 D.V.
 M-Bus to KNX	INKNXMEB***0000	10, 20, 60 & 120 D.V.

Modbus Protocol Translators

General features for Modbus

The Modbus Protocol Translators act as TCP Servers (Ethernet connection) and/or Modbus RTU slaves (serial EIA232,EIA485).

- Modbus TCP and RTU simultaneously
- Coils, holding registers and bitfields supported
- Multiple data formats
- Big-endian or Little-endian

Application	Order Code	P.V. - Point Versions D.V. - Device Versions
 BACnet Client to Modbus Server	IN700485***0000	100, 250, 600, 1200 & 3000 P.V. 
 KNX to Modbus Server	IN701KNX***0000	100, 250, 600, 1200 & 3000 P.V. 
 DALI to Modbus Server	INMBSDAL***0200	64 & 128 D.V.
 M-Bus to Modbus Server	INMBSMEB***0000	10, 20, 60 & 120 D.V.
 Modbus RTU to Modbus TCP router	INMBSRTR0320000	32 D.V.
 OCPP to Modbus Server	INMBSOCP***0100	1 & 20 Chargers

Air conditioning interfaces

Intesis owns a wide portfolio of reliable interfaces for HVAC control, developed with the support and collaboration of the HVAC makers, certified from the main protocols and for all markets. The interfaces are developed with the goal of reducing buildings energy consumption and improve user's comfort.



Intesis – The right choice for HVAC integration

In 2006, Intesis launched the first certified product to integrate expansion air conditioning units into KNX. Today, after many years of experience and more than 1 million HVAC units integrated around the world, Intesis can offer a wide range of Intesis AC Interfaces for integrating air conditioners from major brands into all commonly used building automation protocols.

Energy efficient

HVAC systems account for a major part of the energy costs in a building. With the Intesis AC Interfaces, these can be controlled for optimal energy usage, enabling significant savings.

Reliable

All developments are based strictly on AC manufacturers' specifications, with subsequent validation and approval by the AC manufacturers to ensure the right compatibility with their AC units.

Easy to use

Thanks to the smart scanning functionality, connected AC units can be detected automatically.

Trusted

AC Interfaces from Intesis are trusted by system integrators all over the world, covering all major protocols needed within building automation.

Intesis AC Interfaces – key features



One to one

All the info from one indoor unit directly to one AC Interface.



Multi-unit

Control multiple indoor units from a single AC Interface.



Brand specific products

Specific solutions for all major air conditioning brands.



Direct connection

Save costs by using AC Interfaces that connect directly to the AC bus without any intermediate interface devices.



Universal IR solution

Supports any AC brand on the market that uses infrared (IR) remotes.



AC units scan

Save configuration time with the powerful scanning functionality.



Our expertise packaged in the best solution for you!

HVAC gateways

Multiple indoor unit control

NEW 700 Series Air





Intesis common platform for HVAC integration

700 Series Air is the new platform concept for Intesis AC Interfaces. This concept enables interfaces for multiple HVAC Brands and Building Automation protocols in the same hardware so, the user can pair the combination using Intesis MAPS. The process is called late configuration.

Benefits

- Match your hardware with your HVAC system application with just a few clicks.
- Exchangeable AC brands and system Protocols combinations.
- Common configuration tool for all of them: Intesis MAPS.
- Hardware series for the major AC manufacturers and standard protocols in the market.
- Enable energy efficiency functions by calculating the individual consumption of each indoor unit.

Product features

-  **Stock-Friendly**
All the possible combinations in one product.
-  **3 Binary Inputs**
For Energy Saving purposes.
-  **User-friendly configuration**
Easy to set up with Intesis MAPS, our user-friendly configuration tool.
-  **High capacity**
Up to 128 indoor units depending on the model.
-  **Certification**
International and local certifications. Ready to be sold worldwide

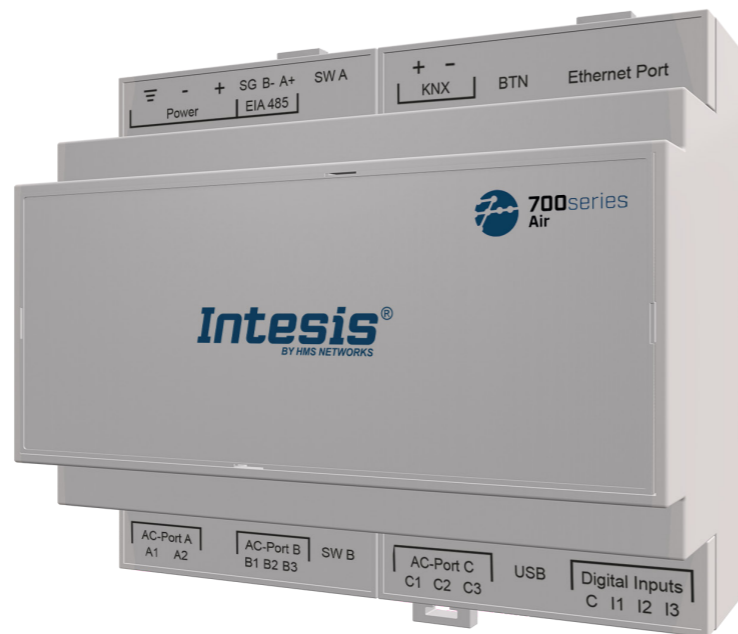

Available applications

Match the brand with the communication protocol

Having different HVAC brands and Building Automation protocols available on the same hardware, enable multiple integration possibilities. Each HVAC to protocol combination is defined as an application.

Intesis MAPS is the configuration tool that will allow you to select the correct application and match your project's needs. Is an easy process you don't need to plan in advance.

700series for AC Interfaces

IN770AIR00*0000

Intesis multi-brand AC Interface with KNX, Serial and IP support - Small & Medium

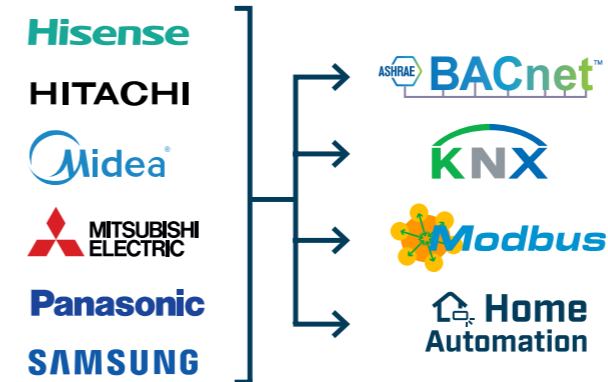

IN771AIR00L0000

Intesis multi-brand AC Interface with KNX, Serial and IP support - Large

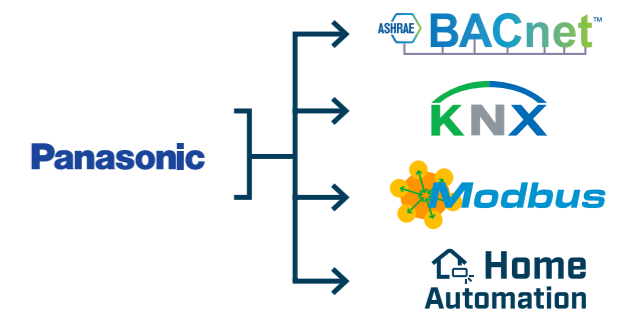

IN776MH100*0000

Mitsubishi Heavy Industries VRF with KNX, Serial and IP support - Small, Medium & Large

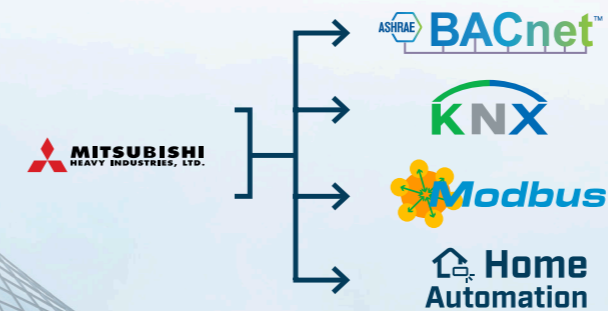

BACnet interfaces for air conditioners

Intesis offers a large portfolio of BACnet interfaces for integration of specific AC brands, supporting both BACnet/IP and BACnet MS/TP integrations with BTL certified solutions.

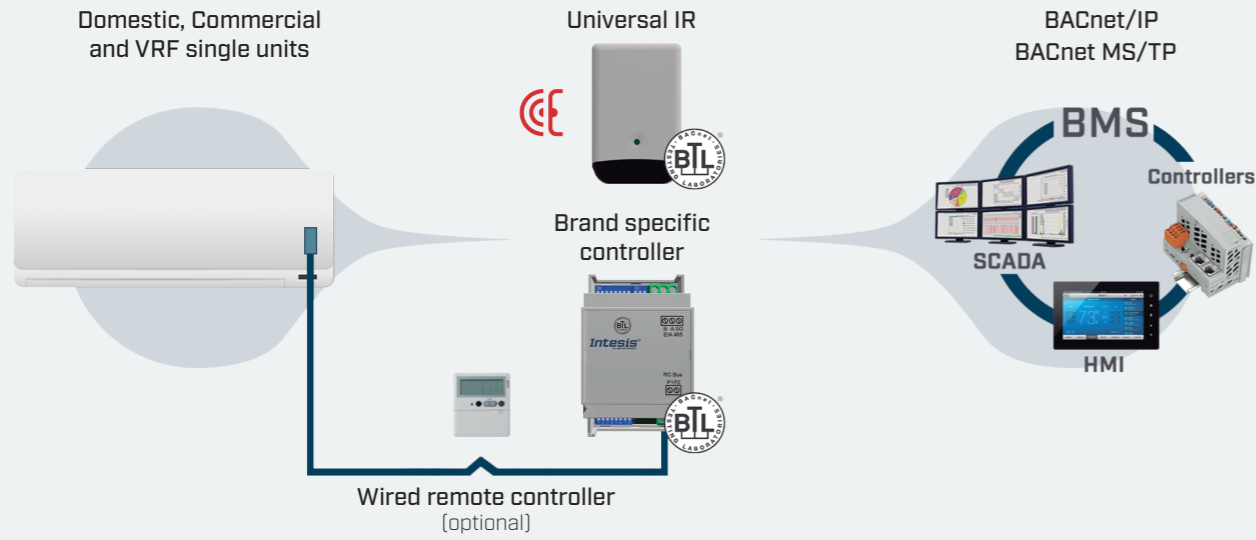

Specific features for one-to-one solutions

- Fast and easy configuration thanks to a dip switches.
- External power supply is not required since it is powered by the AC unit itself.
- Two types of solutions: Brand specific solutions with direct connections supporting the unit's error code data, and a universal solution based on infrared (IR) communication.

Specific features for multi-unit solutions

- Provides advanced BACnet functions such as notification class, trend logs or calendars.
- Controls all connected units from a single BACnet object.



Brand	Product Description	Order Code	Indoor Units	Notes
BOSCH	Commercial and VRF systems to BACnet/IP or MS/TP	INBACACA004I000	4 I.U.	
DAIKIN	AC Domestic units to BACnet/IP or MS/TP	INBACDAI001I000	1 I.U.	NEW
	AC Domestic units to BACnet MS/TP	IN485DAI001I000	1 I.U.	NEW
	VRV and Sky systems to BACnet MS/TP	IN485DAI001R000	1 I.U.	
	VRV and Sky systems to BACnet/IP or MS/TP	INBACDAI001R000	1 I.U.	
FUJITSU	Fujitsu RAC and VRF to BACnet MS/TP	IN485FGL001I000	1 I.U. (to CN connector)	NEW
Hisense	VRF systems to BACnet/IP or MS/TP	IN770AIR00*O000	16 I.U. (S) & 64 I.U. (M)	
HITACHI	VRF systems to BACnet/IP or MS/TP	IN770AIR00*O000	16 I.U. (S) & 64 I.U. (M)	
	Commercial and VRF systems to BACnet/IP or MS/TP	INBACHIT001R000	1 I.U.	
	VRF systems to BACnet MS/TP interface	IN485HIT001R000	1 I.U.	NEW
Midea	Midea Comm. & VRF to BACnet MS/TP	INBACMID001I100	1 I.U.	
	Commercial and VRF systems to BACnet/IP or MS/TP	IN770AIR00*O000	16 I.U. (S) & 64 I.U. (M)	
MITSUBISHI ELECTRIC	Domestic, Mr.Slim and City Multi to BACnet/IP or MS/TP	INBACMIT001I000	1 I.U.	NEW
	Domestic, Mr.Slim and City Multi to BACnet MS/TP	IN485MIT001I000	1 I.U.	
	City Multi systems to BACnet/IP or MS/TP	IN770AIR00*O000	50 Groups (S) & 100 Groups (M)	
MITSUBISHI HEAVY INDUSTRIAL, LTD.	FD and VRF systems to BACnet/IP or MS/TP	INBACMHI001R000	1 I.U.	NEW
	FD and VRF systems to BACnet MS/TP	IN485MHI001R000	1 I.U.	
	VRF systems to BACnet/IP or MS/TP	IN776MHI00*O000	16 I.U. (S), 64 I.U. (M) & 128 I.U. (L)	
Panasonic	Etherea AC units to BACnet/IP or MS/TP	INBACPAN001I000	1 I.U.	NEW
	Etherea AC units to BACnet MS/TP	IN485PAN001I000	1 I.U.	
	ECOi and PACi systems to BACnet/IP or MS/TP	INBACPAN001R000	1 I.U.	
	ECOi and PACi systems to BACnet MS/TP	INBACPAN001R100	1 I.U.	
	ECOi, ECOg and PACi systems to BACnet/IP or MS/TP	IN770AIR00*O000	16 I.U. (S) & 64 I.U. (M)	
	ECOi, ECOg and PACi systems to BACnet/IP or MS/TP	IN771AIR00LO000	128 I.U. (L)	
SAMSUNG	NASA VRF systems to BACnet/IP or MS/TP	IN770AIR00*O000	16 I.U. (S) & 64 I.U. (M)	
	NASA commercial units to BACnet MS/TP	INBACSAM001R100	1 I.U.	
TOSHIBA	VRF and Digital systems to BACnet/IP or MS/TP	INBACTOS001R000	1 I.U.	
	VRF and Digital systems to BACnet MS/TP	INBACTOS001R100	1 I.U.	
UNIVERSAL	Universal IR air conditioner to BACnet MS/TP	IN485UNI001I100	1 I.U.	

KNX interfaces for air conditioners

For the last decade, Intesis AC Interfaces for KNX have been the reference when it comes to integrate air conditioning systems into KNX projects. Specific solutions are offered for the most popular AC brands, including a universal solution based on infrared communication.

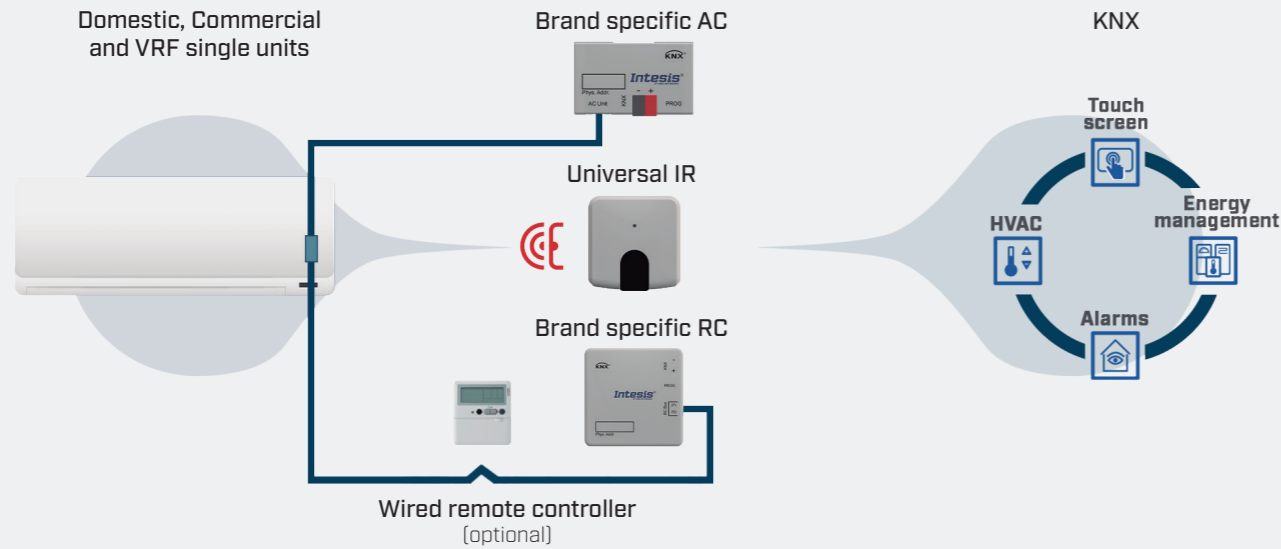

Specific features for one to one solutions

- Supports all required DPT objects to be compatible with all KNX thermostats in the market.
- Binary inputs for window contacts or presence detectors available.
- Two types of solutions: Brand specific solutions with direct connections supporting the unit's error code data, and a universal solution based on infrared (IR) communication.

Specific features for multi-unit solutions

- Smooth integration of KNX thermostats thanks to the "virtual temperature" function.
- Covers a wide range of standard DPTs which ensures interoperability with other KNX devices.



Brand	Order Code	Indoor Units
BOSCH → KNX	Commercial and VRF systems to KNX INKNXACA***I000	1, 16 & 64 I.U.
DAIKIN → KNX	AC Domestic units to KNX INKNXDAI001I000 INKNXDAI001I100 VRV and Sky systems to KNX INKNXDAI001R000 INKNXDAI001R100	1 I.U. 1 I.U. with Binary Inputs 1 I.U. 1 I.U. with Binary Inputs
FUJITSU → KNX	Fujitsu RAC and VRF to KNX INKNXFGL001I000 RAC and VRF systems to KNX INKNXFGL001R000 VRF systems to KNX INKNXFGL016O000	1 I.U. with B.I. (to CN connector) 1 I.U. with B.I. (to remote controller) 16 I.U.
Haier → KNX	Commercial and VRF systems to KNX INKNXHAI***C000	8, 16 & 64 I.U.
Hisense → KNX	VRF systems to KNX INKNXHIS001R000 VRF systems to KNX IN770AIR00*O000	1 I.U. with Binary Inputs 16 I.U. (S) & 64 I.U. (M)
HITACHI → KNX	Commercial and VRF systems to KNX INKNXHIT001R000 VRF systems to KNX IN770AIR00*O000 Air to Water to KNX INKNXHIT001A000	1 I.U. with Binary Inputs 16 I.U. (S) & 64 I.U. (M) 1 I.U.
LG → KNX	VRF systems to KNX INKNXLGE001R000 VRF systems to KNX INKNXLGE***O000	1 I.U. with Binary Inputs 16 & 64 I.U.
Midea → KNX	Commercial and VRF systems to KNX IN770AIR00*O000	16 I.U. (S) & 64 I.U. (M)
MITSUBISHI ELECTRIC → KNX	Domestic, Mr.Slim and City Multi to KNX INKNXMIT001I000 INKNXMIT001I100 City Multi systems to KNX IN770AIR00*O000	1 I.U. 1 I.U. with Binary Inputs 50 Groups (S) & 100 Groups (M)
MITSUBISHI HEAVY INDUSTRIES, LTD. → KNX	FD and VRF systems to KNX INKNXMHI001R000 VRF systems to KNX IN776MHI00*O000	1 I.U. with Binary Inputs 16 I.U. (S), 64 I.U. (M) & 128 I.U. (L)
Panasonic → KNX	Etherea AC units to KNXunit INKNXPAN001I000 ECOi and PACi systems to KNX INKNXPAN001R000 Air to Water (Aquarea H) to KNX INKNXPAN001A000 ECOi, ECOg and PACi systems to KNX IN770AIR00*O000 ECOi, ECOg and PACi systems to KNX IN771AIR00LO000	1 I.U. with Binary Inputs 1 I.U. with Binary Inputs 1 I.U. 16 I.U. (S) & 64 I.U. (M) 128 I.U. (L)
SAMSUNG → KNX	NASA VRF systems to KNX IN770AIR00*O000	16 I.U. (S) & 64 I.U. (M)
TOSHIBA → KNX	VRF and Digital systems to KNX INKNXTOS001R000 VRF systems to KNX INKNXTOS***O000	1 I.U. with Binary Inputs 16 & 64 I.U.
UNIVERSAL → KNX	Universal IR air conditioner to KNX INKNXUNI001I000	1 I.U. with Binary Inputs

Modbus interfaces for air conditioners

Intesis AC Interfaces for Modbus form one of the largest portfolios on the market for integration of air conditioners into Modbus. The consistent Modbus register mapping used for all AC brands helps shortening the integration time in each project.

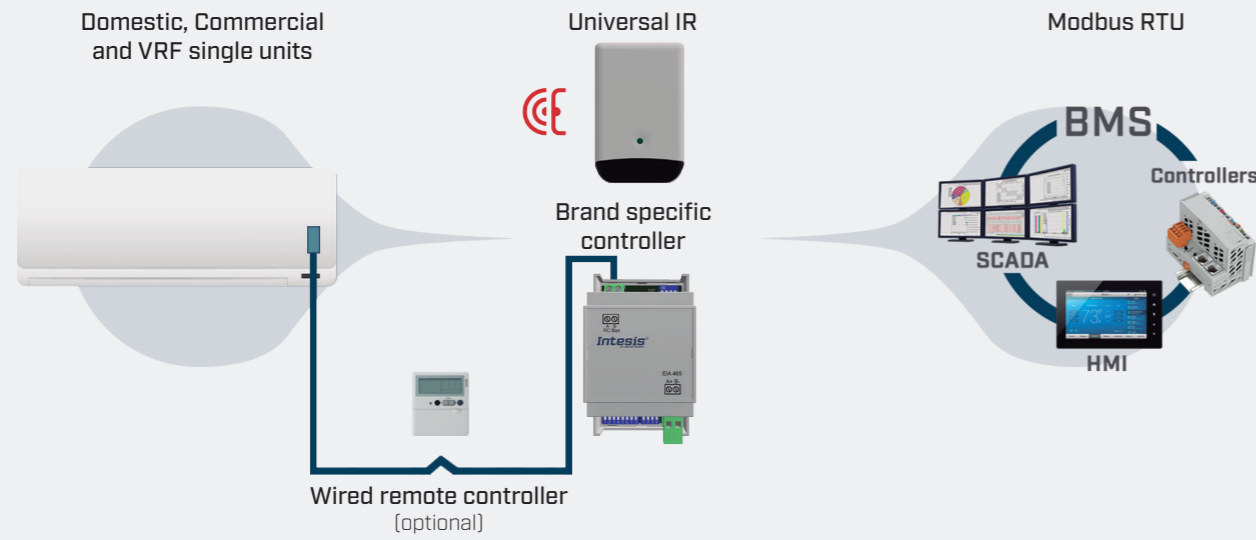

Specific features for one-to-one solutions

- Consistent register mapping presents a common interface for all AC brands.
- Fast and easy configuration thanks to a dip switch on the product.
- Two types of solutions: Brand specific solutions with direct connections supporting the unit's error code data, and a universal solution based on infrared (IR) communication.

Specific features for multi-unit solutions

- Supports both Modbus RTU and TCP simultaneously.
- Control all connected AC units from a single Modbus register.



Brand	Modbus Interface	Order Code	Indoor Units
BOSCH	Commercial and VRF systems to Modbus RTU	INMBSACA***I000	1, 4, 8 & 32 I.U.
DAIKIN	AC Domestic units to Modbus RTU VRV and Sky systems to Modbus RTU	INMBSDAI001I000 INMBSDAI001R000	1 I.U. 1 I.U.
FUJITSU	RAC and VRF systems to Modbus RTU VRF systems to Modbus TCP/RTU	INMBSFGL001R000 IN485FGL001I000 INMBSFGL016O000	1 I.U. (to remote controller) 1 I.U. (to CN connector) 16 I.U.
Hisense	VRF systems to Modbus RTU VRF systems to Modbus TCP/RTU	INMBSHIS001R000 IN770AIR00*O000	1 I.U. 16 I.U. (S) & 64 I.U. (M)
HITACHI	Commercial and VRF systems to Modbus RTU VRF systems to Modbus TCP/RTU	INMBSHIT001R000 IN770AIR00*O000	1 I.U. 16 I.U. (S) & 64 I.U. (M)
LG	VRF systems to Modbus RTU	INMBSLGE001R000	1 I.U.
Midea	Commercial and VRF systems to Modbus RTU	IN770AIR00*O000	16 I.U. (S) & 64 I.U. (M)
MITSUBISHI ELECTRIC	Domestic, Mr. Slim and City Multi lines to Modbus RTU City Multi systems to Modbus TCP/RTU	INMBSMIT001I000 IN770AIR00*O000	1 I.U. 50 Groups (S) & 100 Groups (M)
MITSUBISHI HEAVY INDUSTRIES, LTD.	FD and VRF systems to Modbus RTU VRF systems to Modbus TCP/RTU	INMBSMHI001R000 IN776MHI00*O000	1 I.U. 16 I.U. (S), 64 I.U. (M) & 128 I.U. (L)
Panasonic	Etherea AC units to Modbus RTU ECOi and PACi systems to Modbus RTU Air to Water (Aquarea H) to Modbus RTU ECOi, ECOg and PACi systems to Modbus TCP/RTU ECOi, ECOg and PACi systems to Modbus TCP/RTU	INMBSPAN001I100 INMBSPAN001R000 INMBSPAN001A000 IN770AIR00*O000 IN771AIR00LO000	1 I.U. 1 I.U. 1 I.U. 16 I.U. (S) & 64 I.U. (M) 128 I.U. (L)
SAMSUNG	NASA units to Modbus RTU NASA VRF systems to Modbus TCP/RTU NON-NASA units to Modbus RTU	INMBSAM001R100 IN770AIR00*O000 INMBSAM001R000	1 I.U. 16 I.U. (S) & 64 I.U. (M) 1 I.U.
TOSHIBA	VRF and Digital systems to Modbus RTU	INMBSTOS001R000	1 I.U.
UNIVERSAL	Universal IR air conditioner to Modbus RTU	IN485UNI001I100	1 I.U.

Home Automation interfaces for air conditioners

Intesis Home Automation interfaces have been specifically designed for AC integration into Home Automation systems. The communication is based on a simple ASCII protocol that can be easily implemented as a driver in home controllers or smart hubs. With drivers already available from many Home Automation platforms on the market, air conditioning units can be easily integrated and controlled.

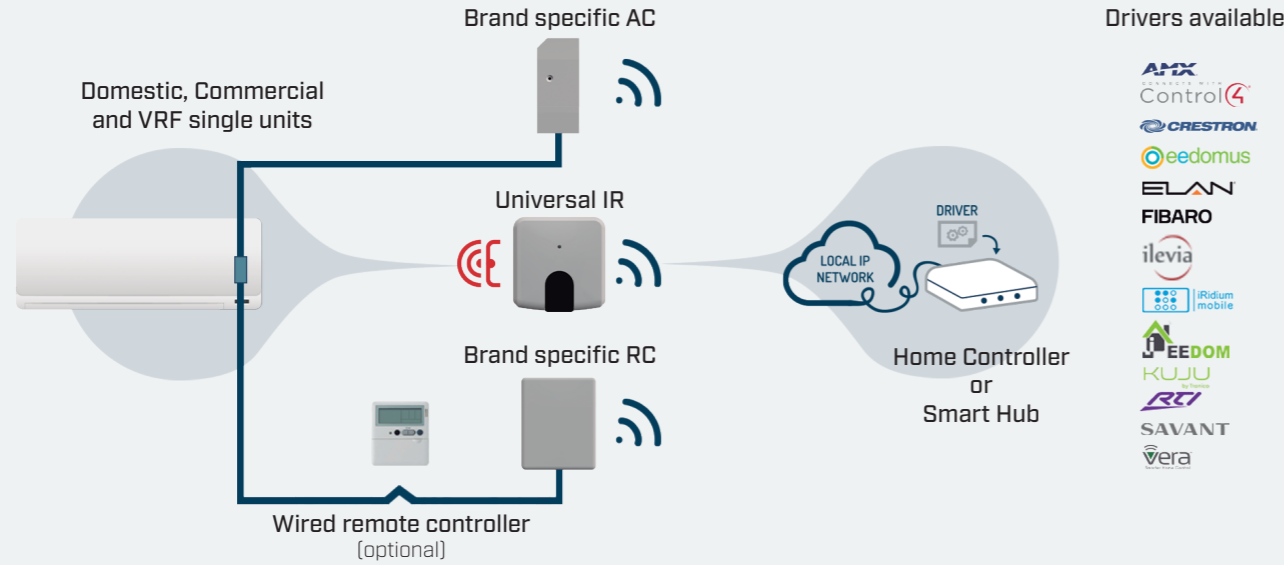

Specific features for one-to-one solutions

- Wi-Fi configuration supporting both dynamic or static IPs.
- Auto-discovering of Wi-Fi devices installed in the network.
- Two types of solutions: Brand specific solutions with direct connections supporting the unit's error code data, and a universal solution based on infrared (IR) communication.

Specific features for multi-unit solutions

- Integrate up to 128 AC units with a single interface.
- Direct ethernet connection to the home's local IP network.
- All the benefits of having Intesis MAPS as configuration and diagnostic tool.



DAIKIN	Home Automation	Order Code	Indoor Units
AC Domestic units to Home Automation		INWMPDAI001I000	1 I.U.
VRV and Sky systems to Home Automation		INWMPDAI001R000	1 I.U.
FUJITSU	Home Automation		
RAC and VRF systems to Home Automation		INWMPFGL001R000	1 I.U. (to remote controller)
VRF systems to Home Automation		INWMPFGL001I000	1 I.U. (to CN connector)
		INMBSFGL016O000	16 I.U.
Hisense	Home Automation		
VRF systems to Home Automation		IN770AIR00*O000	16 I.U. (S) & 64 I.U. (M)
HITACHI	Home Automation		
VRF systems to Home Automation		IN770AIR00*O000	16 I.U. (S) & 64 I.U. (M)
LG	Home Automation		
VRF systems to Home Automation		INWMPPLGE001R000	1 I.U.
Midea	Home Automation		
Commercial & VRF systems to Home Automation		IN770AIR00*O000	16 I.U. (S) & 64 I.U. (M)
MITSUBISHI ELECTRIC	Home Automation		
Domestic, Mr.Slim and City Multi to Home Automation		INWMPMIT001I000	1 I.U.
City Multi systems to Home Automation		IN770AIR00*O000	50 Groups (S) & 100 Groups (M)
MITSUBISHI HEAVY INDUSTRIES, LTD.	Home Automation		
FD and VRF systems to Home Automation		INWMPMHIO01R000	1 I.U.
Domestic units to Home Automation		INWMPMHIO01I000	1 I.U.
VRF systems to Home Automation		IN776MHIO0*O000	16 I.U. (S), 64 I.U. (M) & 128 I.U. (L)
Panasonic	Home Automation		
Etherea AC units to Home Automation		INWMPAN001I000	1 I.U.
ECOi and PACi systems to Home Automation		INWMPAN001R000	1 I.U.
ECOi, ECOg and PACi systems to Home Automation		IN770AIR00*O000	16 I.U. (S) & 64 I.U. (M)
ECOi, ECOg and PACi systems to Home Automation		IN771AIR00LO000	128 I.U. (L)
SAMSUNG	Home Automation		
NASA VRF systems to Home Automation		IN770AIR00*O000	16 I.U. (S) & 64 I.U. (M)
TOSHIBA	Home Automation		
VRF and Digital systems to Home Automation		INWMPDOS001R000	1 I.U.
UNIVERSAL	Home Automation		
Universal IR air conditioner to Home Automation		INWMPUNI001I000	1 I.U.

More than 2.500 compatible indoor unit models



SELECT LANGUAGE

PRODUCTS ▾ SUPPORT ▾ SOLUTIONS ▾ CONTACT ▾ ABOUT US ▾

Intesis AC Compatibility tool

Find the appropriate solution for your HVAC integration in our database with more than 2.500 AC indoor unit models available

AC Compatibility Tool

The new AC compatibility tool provides a fast and reliable way to check the compatibility of air conditioning units with Intesis interfaces.

Forget the time-consuming task of searching an AC unit's reference into an endless compatibility document. Thanks to the search engine of the new web-based tool, get the answer you are looking for with a click.



Search Engine

Type the first letters of your AC reference and get suggestions to make the search even easier.



Updated information

We can ensure updated information thanks to the ease of maintenance of the tool.



Compatible AC units

More than 2500 models already in our database. New units are included every day!



The support behind

Can't you find your AC unit in the database? Send us a request and we will indicate you the best solution for your AC.

Intesis helps you to reduce your carbon footprint

Intesis is committed to reduce the CO₂ emission of air conditioning units by offering the best integration product portfolio.

For more than 10 years, we have provided gateways to control more than 1 million air conditioning units around the world. The estimated energy consumption from these units is more than 1,7 billion kWh/year. But thanks to our gateways, 509 million kWh are saved, that means 150 million on Kg CO₂ savings.

This figure is equivalent to the total CO₂ that 652 million PCs generate during an hour, or the same than 6 million trees absorb in one year.



CO₂ saved by...
6,000,000 trees
in one year



CO₂ generated by...
23,438 European people
in a year



CO₂ generated by...
652,173,913 PC working
during one hour



CO₂ generated by...
340,909 flights
from London to New York

Cloud Solutions

Intesis brings extensive experience in developing communication interfaces for HVAC integration, now available on the cloud for convenient remote management. With these platforms, you can easily control and monitor any building from anywhere and at any time.



Empowering Smart Building Automation

The increasing global adoption of internet technologies has spurred demand in the building automation market for intelligent connectivity solutions.

Intesis meets this demand with their cloud solutions powered by HMS Hub™, enabling customers to securely monitor and control previously unconnected devices from a remote location. These end-to-end solutions are packaged for effortless deployment, encompassing all necessary elements to get started.



Native application

End-user-oriented Android and iOS App for mobile device management.



Web dashboard

Professional web based device management tool developed for real-time control and monitoring of the installation.



Flexible and adaptable

Adaptable cloud solutions for any project size, need and location, such as residential buildings, schools, bank offices, shops, public buildings and more.



Multi-site projects

Ideal for projects with distributed installations. Allows multiple sites to be controlled from the same dashboard.



User and permission management

Grant access for other users and set permissions based on individual needs.



Quick installation

Easy-to-install devices and intuitive configuration tools for fast project commissioning.



Cloud management leads to increased energy efficiency and cost savings

Intesis ST Cloud Control

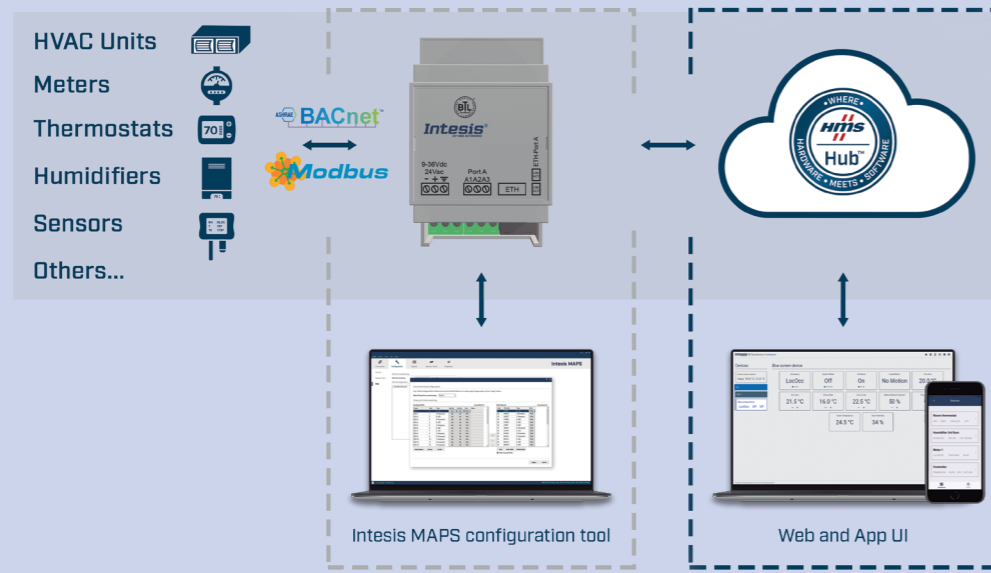

Intesis ST Cloud Control is an HMS cloud-based solution which enables easy monitoring and control of any BACnet or Modbus device by using our end user oriented App and web based dashboard.

Users simply need to install the ST Cloud Control gateway in the desired location and use Intesis MAPS for PC-based configuration. Here, the widgets can be created (e.g., Booleans, Operating Modes, Dimmers, Analog Values, Error Signals, etc.), mapping them with the BACnet objects or Modbus registers of choice.

Once the gateway is configured and assigned to a user, all devices and widgets will appear automatically in the App and web interfaces, presented in a dashboard. Each user is allowed to create their own customized dashboards, in which devices and widgets can be renamed and reorganized according to personal preferences.



Manage and control any BACnet or Modbus device from an App or web interface

With ST Cloud Control you are able to connect all types of BACnet or Modbus devices to the cloud, for an intuitive and centralized remote device management through an App or a web interface using a common dashboard.



Gateway features

- BACnet/IP or MS/TP or Modbus TCP/RTU connectivity.
- Up to 32 devices can be connected to each gateway.
- Up to 12 widgets per device.
- Easy device configuration using Intesis MAPS.



Next level service

- Industrial grade connectivity now for Building Automation.
- Fast and scalable real time edge connectivity over HMS Hub™.
- Full data control and protection.
- Secure and remote updates during the application lifetime.



System Features

- Monitor and control all devices in an intuitive way.
- Comes with a native iOS and Android App and a web interface.
- Create scenes and interact with multiple concurrent devices.
- Weekly calendar that shows the daily planned installation commands.
- Notifications keep you updated about system status.
- Device sharing and user permissions management.
- Multiple site management from a common dashboard.

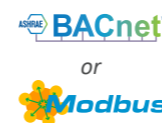

BACnet or Modbus

ST Cloud Control

Order Code

Device Versions

INSTCMBG***0000

4, 8, 16 & 32 D.V.

Make conventional BACnet or Modbus devices smart with Intesis ST Cloud Control

Intesis AC Cloud Control

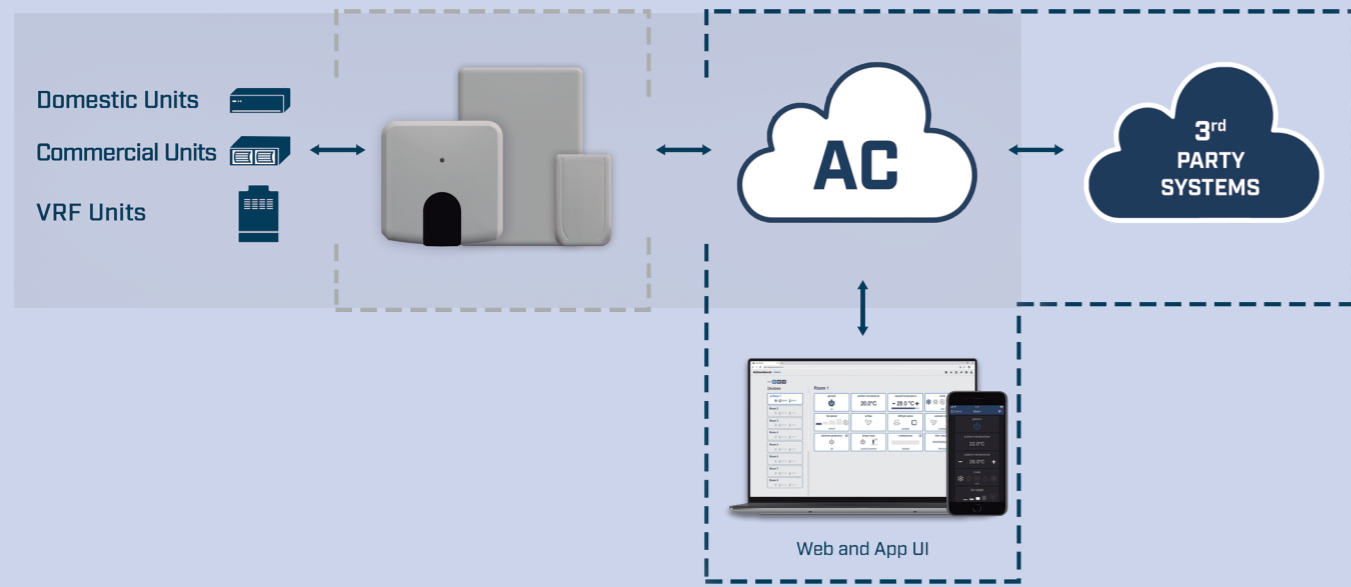

AC Cloud Control is an HVAC IoT solution that allows comfortable and intuitive control of air conditioners and heat pumps from a smartphone, tablet, smart watch or from a simple internet browser.

The AC Cloud Control gateways, developed together with the major AC manufacturers, offer cloud connectivity to a wide range of compatible AC units. No cables are needed for cloud connectivity, as the devices use Wi-Fi technology to bring all the data to the cloud.

The bidirectional communication between Intesis devices and the AC unit, ensures the end user can keep using the manufacturers remote controller if desired, while keeping the cloud system updated with the real status of the HVAC units.

The gateways can be managed using a web-based dashboard, so no additional management tool needs to be installed. User friendly Android and iOS Apps are available.

Control the HVAC system remotely and reduce up to 30% of energy

AC Cloud Control Functionalities

Remote control	ON/OFF	T° Set point	MODE	Ambient T°	Fan & vane control
Smart	Email & push notifications	Timer & scenes	Multi-language	Error codes & descriptions ¹	
	Voice over	Anti-frost & ² overheat	Operating hours	Auto updates	
Professional	Maintenance & filter cleaning	Binary input	Schedule calendar	T° limitation	Multiple sites

1: not available for the Universal IR gateway
2: only available for the Universal IR gateway

AC Cloud Control main strengths

Multiple brands and multiple sites Organize any brand and model in three different levels.	Energy saving and maintenance functionalities Special functionalities to help our customers increase energy efficiency.
Secondary users Manage who can monitor and control each unit.	Professional API for 3rd party integration Connect your system to Intesis Cloud Solutions and offer bidirectional HVAC control to your customers.
Email and push notifications Be aware of everything that happens in your climate system.	OEM projects Reduce the time to market and maintenance costs, our R&D resources are at your disposal.

Effortless and Secure Remote AC Management

AC Cloud Control devices are designed to enable remote control of air conditioning units through cloud connectivity. These devices use the local Wi-Fi network to establish a reliable data connection, operating at a frequency of 2.4GHz and compatible with b/g/n. The communication between devices is optimized for IoT, ensuring minimal communication issues.

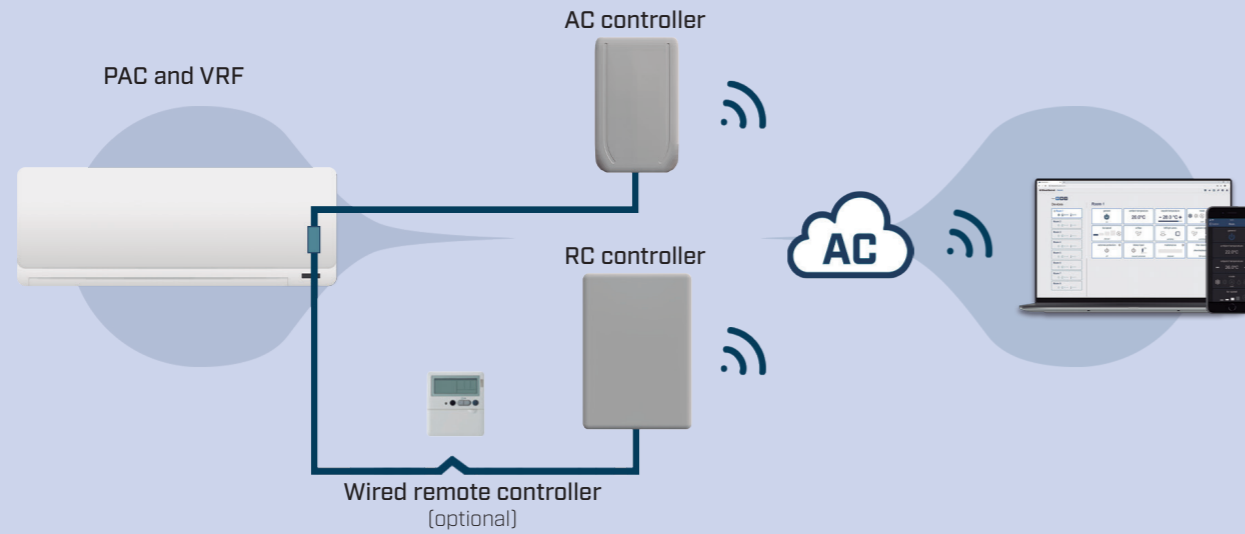

Specific features for brand specific devices

- Devices designed and developed along with the major AC manufacturers, using the proprietary communication protocol of each manufacturer.
- Offers advanced parameters like error signals, error codes, power consumption*.
- Domestic controllers are directly connected to the internal electronic card, and specifically designed for RAC and domestic lines.
- The VRF and commercial interfaces are connected to the HVAC remote control bus, and specifically designed for PAC and VRF.

Specific features for universal controller

- Offers compatibility for thousands of AC models.
- Only requires an indoor unit that has an IR receiver working with a standard wireless infrared remote controller.
- The AC feedback is enabled through the embedded IR receiver.
- Allows using the universal and the manufacturer's controller at the same time.
- The Universal controller is specifically designed for PAC, RAC and VRF.



DAIKIN	AC Cloud Control	Order Code	Indoor Units
AC Domestic units to Wi-Fi (ASCII)		INWFIDA1001I100	1 I.U.
VRV and Sky systems to Wi-Fi (ASCII)		INWFIDA1001R100	1 I.U.

FUJITSU	AC Cloud Control	Order Code	Indoor Units
RAC and VRF systems to Wi-Fi (ASCII)		INWFIFGL001I100	1 I.U.
		INWFIFGL001R100	1 I.U.

LG	AC Cloud Control	Order Code	Indoor Units
VRF systems to Wi-Fi (ASCII)		INWFILGE001R100	1 I.U.

MITSUBISHI	AC Cloud Control	Order Code	Indoor Units
FD and VRF systems to Wi-Fi (ASCII)		INWFIMHI001I100	1 I.U.
Domestic units to Wi-Fi (ASCII)		INWFIMHI001R100	1 I.U.

Panasonic	AC Cloud Control	Order Code	Indoor Units
Etherea AC units to Wi-Fi (ASCII)		INWFIPAN001I100	1 I.U.
ECOi and PACi systems to Wi-Fi (ASCII)		INWFIPAN001R100	1 I.U.

TOSHIBA	AC Cloud Control	Order Code	Indoor Units
VRF and Digital systems to Wi-Fi (ASCII)		INWFITOS001R100	1 I.U.

UNIVERSAL	AC Cloud Control	Order Code	Indoor Units
Universal IR air conditioner to Wi-Fi (ASCII)		INWFIUNI001I000	1 I.U. with Binary Inputs



Work with HMS.
The number one choice for
Industrial Information &
Communication Technology.

HMS Networks - Contact

HMS is represented all over the world.
Find your nearest contact here:

www.hms-networks.com/contact

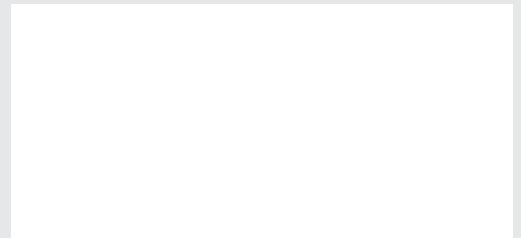

Owned by HMS Industrial Networks, Intesis® is a registered trademark in the European Union and is trademarked in the rest of the world. Other marks and words belong to their respective companies. All other product or service names mentioned in this document are trademarks of their respective companies.
Part No: INBR-EN-GE Version 2.0/2023 - © HMS Industrial Networks - All rights reserved - HMS reserves the right to make modifications without prior notice.



www.intesis.com