



LED Display Product Data Sheet LTS-3361JD

Spec No.: DS30-2001-436

Effective Date: 09/30/2003

Revision: A

LITE-ON DCC

RELEASE

BNS-OD-FC001/A4

FEATURES

- * 0.3 inch (7.62 mm) DIGIT HEIGHT
- * CONTINUOUS UNIFORM SEGMENTS
- * LOW POWER REQUIREMENT
- * EXCELLENT CHARACTERS APPEARANCE
- * HIGH BRIGHTNESS & HIGH CONTRAST
- * WIDE VIEWING ANGLE
- * SOLID STATE RELIABILITY
- * CATEGORIZED FOR LUMINOUS INTENSITY

DESCRIPTION

The LTS-3361JD is a 0.3 inch (7.62 mm) height digit display. The device uses AS-AllnGaP HYPER RED LED chips (AllnGaP epi on GaAs substrate). The display has light gray face and white segments.

DEVICE

PART NO.	DESCRIPTION
AllnGaP HYPER RED	Common Cathode
LTS-3361JD	Rt. Hande Decimal

PACKAGE DIMENSIONS

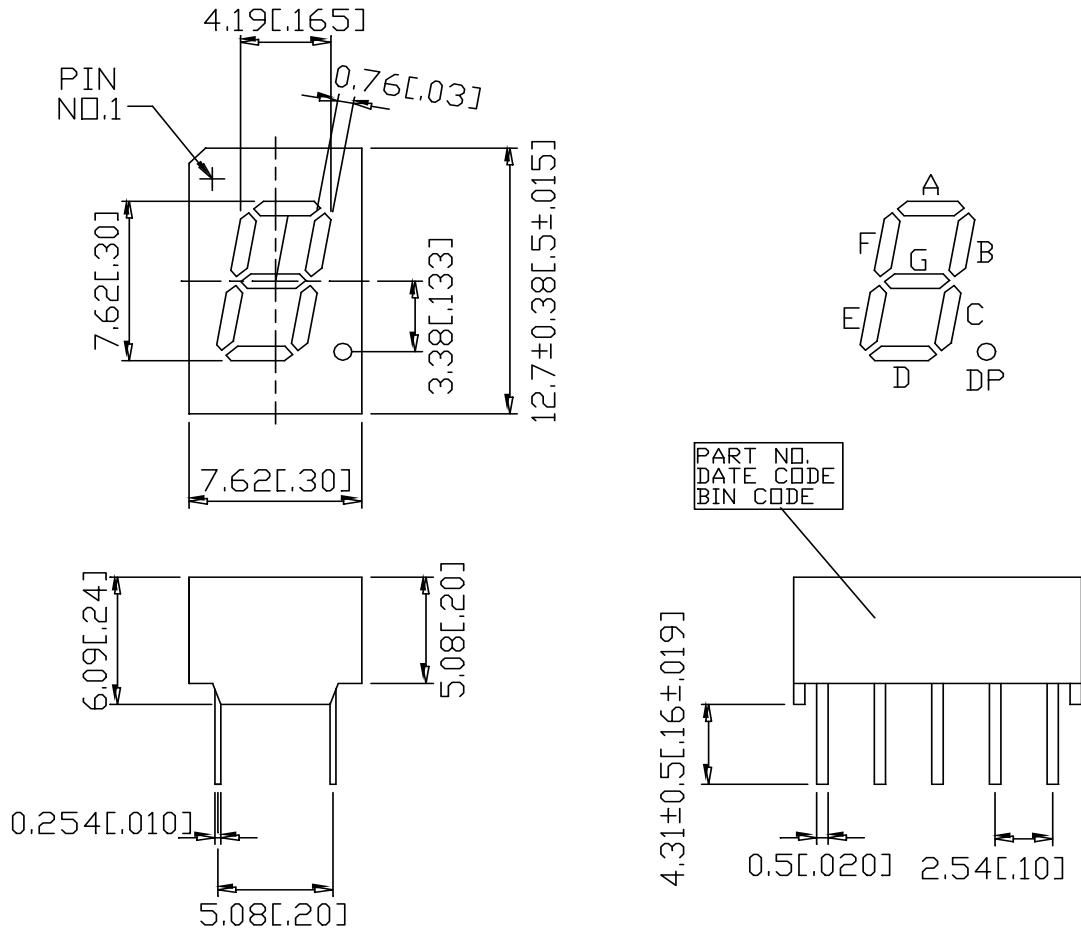

NOTES: All dimensions are in millimeters. Tolerances are ± 0.25 mm (0.01") unless otherwise noted.

INTERNAL CIRCUIT DIAGRAM

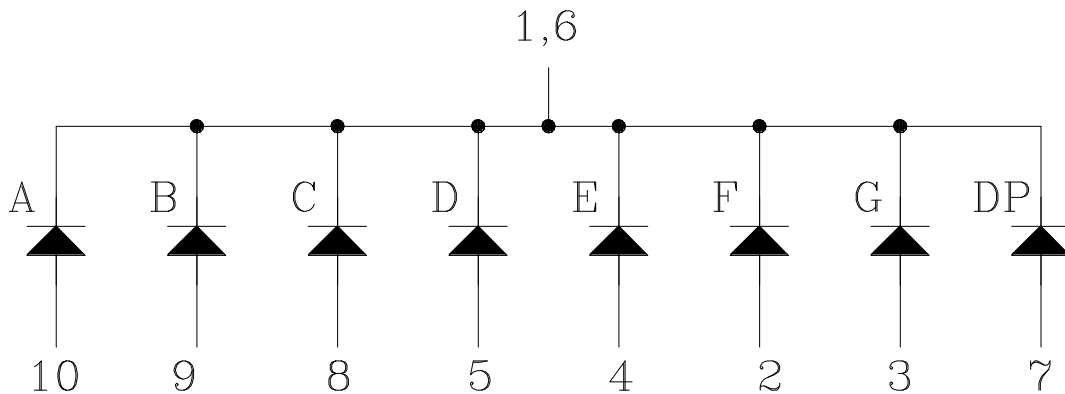

PIN CONNECTION

No.	CONNECTION
1	COMMON CATHODE
2	ANODE F
3	ANODE G
4	ANODE E
5	ANODE D
6	COMMON CATHODE
7	ANODE DP
8	ANODE C
9	ANODE B
10	ANODE A

ABSOLUTE MAXIMUM RATING

PARAMETER	MAXIMUM RATING	UNIT
Power Dissipation Per Segment	70	mW
Peak Forward Current Per Segment (Frequency 1Khz, 18% duty cycle)	90	mA
Continuous Forward Current Per Segment	25	mA
Forward Current Derating from 25 ⁰ C	0.33	mA/°C
Reverse Voltage Per Segment	5	V
Operating Temperature Range	-35°C to +85°C	
Storage Temperature Range	-35°C to +85°C	
Soldering Conditions : 1/16 inch below seating plane for 3 seconds at 260 ⁰ C		

ELECTRICAL / OPTICAL CHARACTERISTICS AT Ta=25°C

PARAMETER	SYMBOL	MIN.	TYP.	MAX.	UNIT	TEST CONDITION
Average Luminous Intensity Per Segment	I _v	200	600		μcd	I _F =1mA
Peak Emission Wavelength	λ _p		650		nm	I _F =20mA
Spectral Line Half-Width	Δλ		20		nm	I _F =20mA
Dominant Wavelength	λ _d		639		nm	I _F =20mA
Forward Voltage Per Segment	V _F		2.1	2.6	V	I _F =20mA
Reverse Current Per Segment	I _R			100	μA	V _R =5V
Luminous Intensity Matching Ratio	I _v -m			2:1		I _F =1mA

Note: Luminous intensity is measured with a light sensor and filter combination that approximates the CIE (Commision Internationale De L'Eclairage) eye-response curve.

TYPICAL ELECTRICAL / OPTICAL CHARACTERISTIC CURVES

(25°C Ambient Temperature Unless Otherwise Noted)

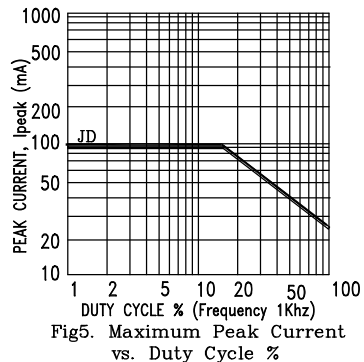
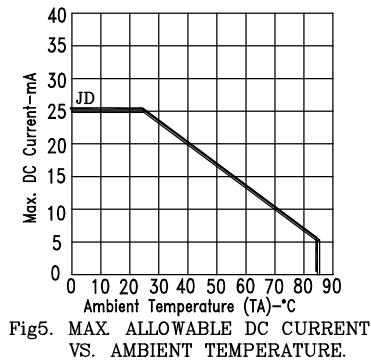
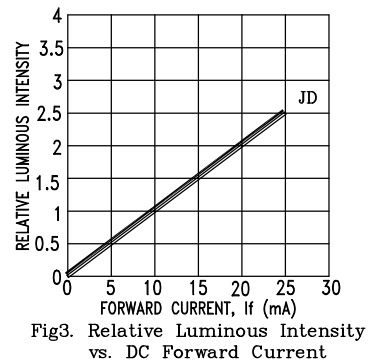
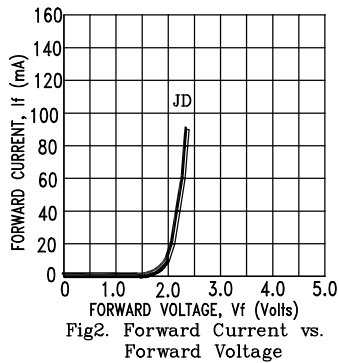
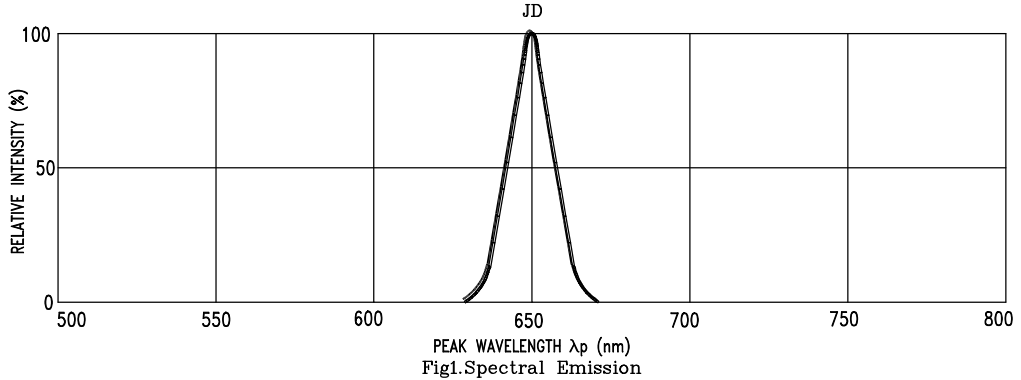

NOTE : JD=AlInGaP HYPER RED