

Table of Contents

Chapter 1. Introduction.....	2
1.1 General Description	2
1.2 AP3928 Key Features	2
1.3 Applications	2
1.4 Board Pictures	2
Chapter 2. Power Supply Specification	3
2.1 System Performance.....	3
2.2 Environment.....	3
Chapter 3. Schematic and Bill of Material	4
3.1 Schematic.....	4
3.2 Bill of Material.....	4
Chapter 4. The Evaluation Board Connections	5
4.1 PCB Layout	5
4.2 Circuit Description	5
4.2.1 Input EMI Filtering	5
4.2.2 Control IC.....	5
4.2.3 Output Rectification	5
4.2.4 Output Feedback	5
4.3 Quick Start Guide.....	5
Chapter 5. System Test	6
5.1 Input & Output Characteristics.....	6
5.1.1 Input Standby Power	6
5.1.2 Efficiency	6
5.1.3 Line and Load Regulation	7
5.2 Key Performance Test	9
5.2.1 Start up Performance	9
5.2.2 Rise Time	10
5.2.3 Voltage Stress	11
5.2.4 Output Ripple & Noise.....	12
5.2.5 Dynamic Response.....	13
5.3 Protection Test	14
5.3.1 Short Circuit Protection (SCP) Test	14
5.3.2 Open Loop Detection (OLD) Protection Test.....	14
5.3.3 Over Load Protection (OLP) Test	15
5.4 Thermal Test	15
5.5 System EMI Scan.....	16
5.5.1 Conducted EMI Test of 230V@full load	16
5.5.2 Conducted EMI Test of 110V@full load	17

Chapter 1. Introduction

1.1 General Description

AP3928 is an off-line universal AC Voltage input step-down regulator which provides accurate constant voltage (CV) output, outstanding low standby power, high efficiency at light loading and excellent dynamic response based on non-isolated buck topology.

The AP3928 EV1 Evaluation Board provides a good design example for a cost-effective 9.9W single output 18V/550mA power application used in home appliances.

1.2 AP3928 Key Features

- Universal 85V to 265V V_{AC} Input
- Internal MOSFET 700V (6.5 Ω max)
- Maximum 600mA rated Output current
- Low Standby Power Consumption (<30mW at no load)
- High Light-Loading and Average efficiency can meet DOE and CoC requirement
- Frequency Modulation to suppress EMI to meet EN55022 class B
- Rich Protection including: OTP, OLP, OLD, SCP
- Extremely low system component count
- Totally Lead-free & Fully RoHS Compliant (SO-8)
- Halogen and Antimony Free. "Green" Device

1.3 Applications

- Non-Isolated Home Appliances: AC Fans, Rice Cookers, Air conditioners, Coffee Machines, Soy Milk Machines, etc.
- Auxiliary Power for IoT Devices.

1.4 Board Pictures

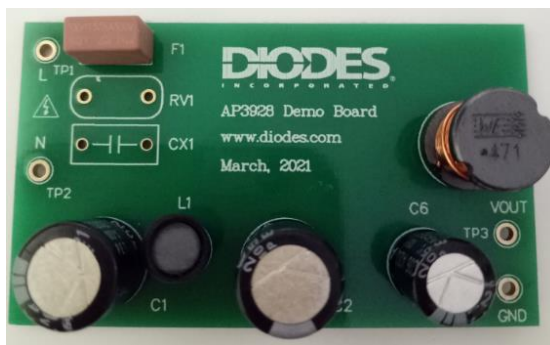

Figure 1: Top View

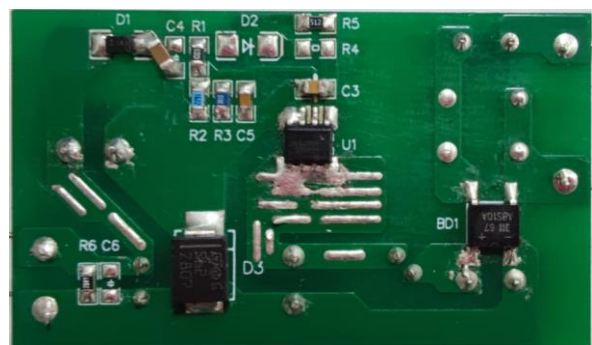

Figure 2: Bottom View

Chapter 2. Power Supply Specification

2.1 System Performance

The system performance contains input/output characters, specifications, EMC, protections, and etc.

		Min.	Typ.	Max.	Comments
Input Characters					
Input AC voltage rating		100V/60Hz	115/230	240V/50Hz	Two wires, no PE
Input AC voltage range		85V/60Hz	-	265V/50Hz	
Input AC frequency range		47Hz	50/60	63Hz	
Output Characters					
Output voltage		17.1V	18V	18.9V	Tested at board terminal
Output tolerance		-		±5%	
Loading current			550		mA
Measurement Performance					
Standby power		-	16.5mW		@230V/50Hz
Efficiency standard	115Vac	10% load	87.88%	-	DoE VI: 71.97% CoC V5 tier 2: 72.03%/62.03%
		Avg. eff.	86.81%	-	
	230Vac	10% load	85.39%	-	
		Avg. eff.	85.82%	-	
Load regulation		-	±2.19%	-	Tested at board terminal
Line regulation		-	±0.28%	-	Tested at board terminal
Ripple & Noise		-	57.6mV	-	@full load and full voltage range
Startup time		-	18.6ms	-	85V/60Hz
EMC Test					
ESD test	Air	15kV	-	-	@100Ω concrete resistor
	Contact	8kV	-	-	
EFT test		2kV	-	-	±5kHz/100kHz
Surge Test		1kV	-	-	Differential mode, 2ohm, 1.2/50us
Conduction EMI	110V	6dB margin	-	-	FCC Part 15 Class B
	230V	6dB margin	-	-	EN55022
Protection Functions					
SCP test		-	-	-	OK
OLD test		-	-	-	OK
OLP test		-	8.2V	-	OK
OTP test		135°C	150°C	165°C	OK(IC internal Temp)

2.2 Environment

Operation temperature:	-20°C~85°C
Operation Humidity:	20%~90% R.H.
Storage temperature:	0~40°C
Storage Humidity:	0%~95% R.H.

Chapter 3. Schematic and Bill of Material

3.1 Schematic

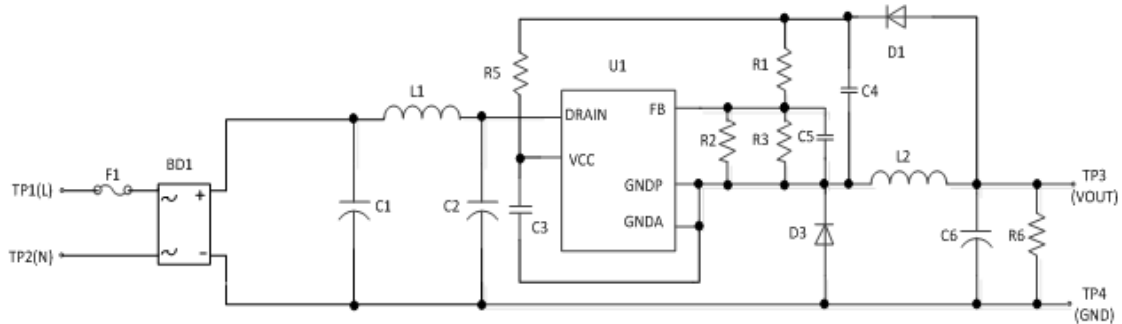

Figure 3: Evaluation Board Schematic

3.2 Bill of Material

Table 1: Bill of Material

Items	Designator	Description	Footprint	Qty.	Manufacturer
1	F1	3.15A/300V; Fuse	8*4*8mm	1	OAHE
2	BD1	ABS10A	SOPA-4	1	Diodes
3	C1, C2	10uF/400V, Electrolytic capacitor	Φ10*13mm	2	Rubycon
4	C3	2.2μF/25V, X7R	SMD 0805	1	Murata
5	C4	1μF/50V, X7R	SMD 1206	1	Murata
6	C5	1.5nF/50V, X7R	SMD 0805	1	Murata
7	C6	220μF/35V, Electrolytic capacitor	Φ8*12mm	1	Rubycon
8	D1	RS1MSWF; Fast type diode	SOD123F	1	Diodes
9	D3	STTH2R06S; Fast diode, 2A/600V	SMC	1	ST
10	L1	220μH; Inductor, 0.96Ω, 0.5A	DIP, Φ5*8mm	1	Würth
11	L2	470μH; Inductor, 0.47Ω, 1.15A	DIP, Φ10*15mm	1	Würth
12	R1	100kΩ	SMD 0805, 1%	1	Yageo
13	R2	16.2kΩ	SMD 0805, 1%	1	Yageo
14	R3	300.1kΩ	SMD 0805, 1%	1	Yageo
15	R5	5.1kΩ	SMD 0805, 5%	1	Yageo
16	R6	68kΩ	SMD 0805, 5%	1	Yageo
17	U1	AP3928	SO-8	1	Diodes
Total		18pcs			

Chapter 4. The Evaluation Board Connections

4.1 PCB Layout

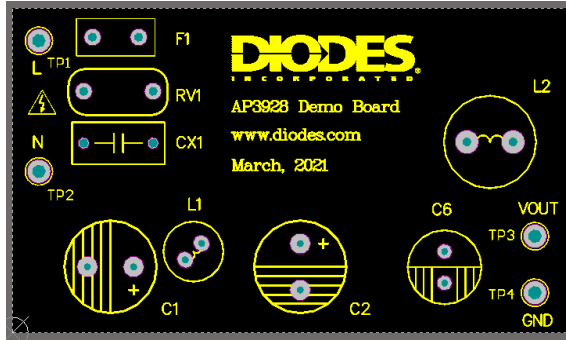

Figure 4: PCB Board Layout Top View

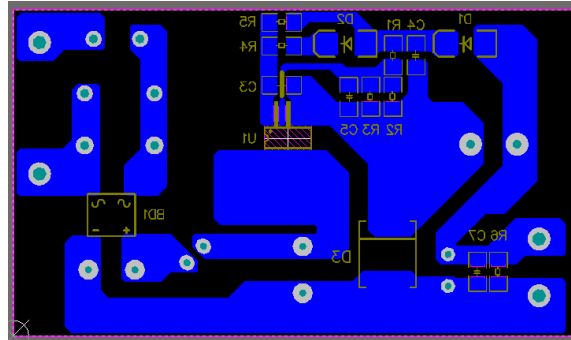

Figure 5: PCB Board Layout Bottom View

4.2 Circuit Description

4.2.1 Input EMI Filtering

The input stage is composed of fusible resistor F1, rectifier bridge DB1, filtering inductor L1, Capacitors C1 and C2. Resistor F1 is a flame proof, fusible, wire-wound resistor. It limits inrush current to safe levels for input rectifier diodes, provides differential mode noise reduction and acts as an input fuse in the event of short circuit.

4.2.2 Control IC

AP3928 co-packages a 700V power MOSFET and control circuitry into a cost-effective SO-8 package. The device is self-starting from the Drain pin with local supply decoupling provided by a small capacitor C3 (at least 100nF) connected to the BP pin when AC source is applied.

4.2.3 Output Rectification

During the ON time of U1, current ramps in L2 and is simultaneously delivered to the load. During the OFF time the inductor current ramps down via the free-wheeling diode D3, feedback diode D1, and the load. Diode D3 should be an ultra-fast diodes ($T_{rr} < 50\text{ns}$ or lower). Capacitor C3 should be selected to have an adequate ripple margin (low ESR type).

4.2.4 Output Feedback

The voltage across L2 is rectified by C4 and D1 during the off-time of U1. For forward voltage drop of D1 and D3 is approximately equal, the voltage across C4 tracks the output voltage. To provide a feedback signal, the voltage across C4 is divided by R1 and R2/R3. This voltage is specified for U1 at FB pin (2.5V). This allows the simple feedback to meet the required overall output tolerance of $\pm 5\%$ at rated output current.

4.3 Quick Start Guide

1. The evaluation board is preset at 18V/550mA from output.
2. Ensure that the AC source is switched OFF or disconnected before doing connection.
3. Connect the AC line wires of power supply to "L" & "N" connectors on the left side of the board.
4. Turn on the AC main switch.
5. Measure "+V" & "GND" connectors to ensure correct output voltage, 18V.

CAUTION: This EV board is non-isolated. Do not touch anywhere there are electrical connections because they are all coupled to high voltage potential.

Chapter 5. System Test

5.1 Input & Output Characteristics

5.1.1 Input Standby Power

Standby power and output voltage is measured after 10-minute aging. The voltage data is tested at the PCB terminal. All data is tested at ambient temperature.

Table 2: Standby Power and Output Voltage @ no load

AC input Voltage	Pin (mW)	Vo (V)
85V/60Hz	13.2	19.025
115V/60Hz	13.7	19.015
230V/50Hz	15.8	19.006
265V/50Hz	16.5	18.999

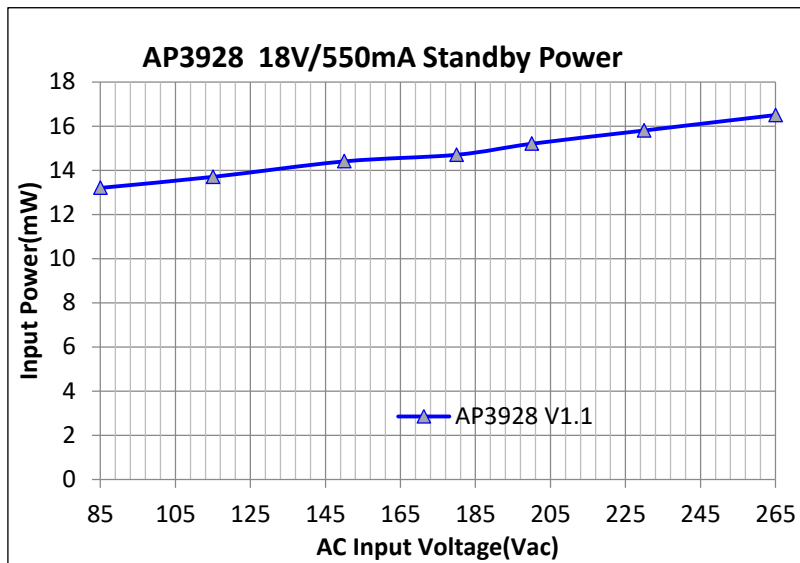

Figure 6: Standby Power versus Vin Curve

5.1.2 Efficiency

The efficiency data is measured after 10-minute aging, and it is tested at the PCB terminal. All the data is tested at ambient temperature.

Table 3: Conversion Efficiency

AC input voltage	Items	10%	25%	50%	75%	100%	Avg. Eff.
115V/60Hz	Vo (V)	18.603	18.537	18.514	18.513	18.502	86.81%
	Io (mA)	55	137.5	275	412.5	550	
	Pin (W)	1.0231	2.5488	5.0913	7.6366	10.1761	
	Efficiency (%)	87.88%	87.24%	87.39%	86.54%	86.07%	
230V/50Hz	Vo (V)	18.565	18.513	18.491	18.492	18.488	85.82%
	Io (mA)	55	137.5	275	412.5	550	
	Pin (W)	1.0211	2.5455	5.0851	7.6279	10.1684	
	Efficiency (%)	85.39%	85.04%	85.47%	86.56%	86.24%	

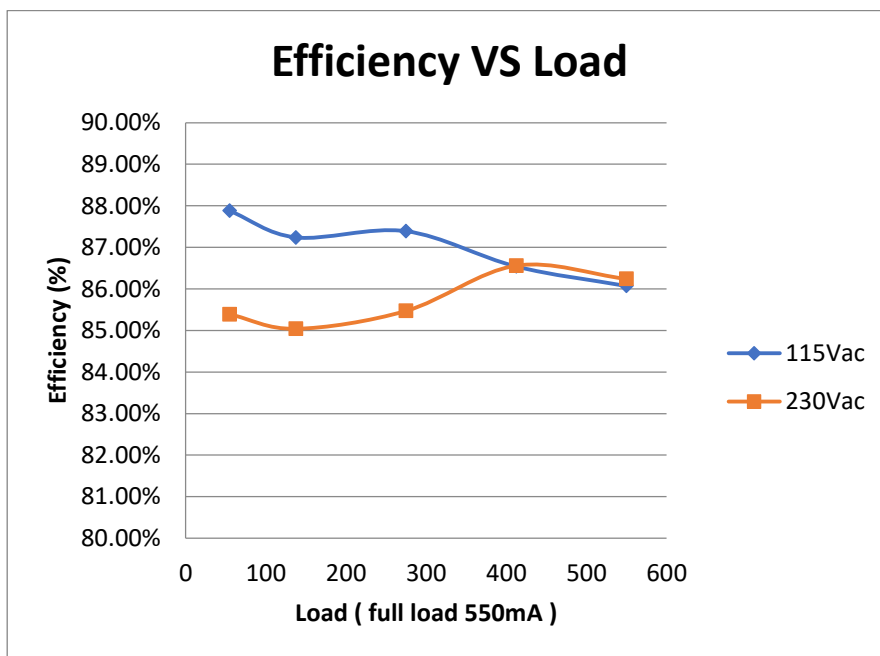

Figure 7: Efficiency versus Loading Curve

1.4.1

5.1.3 Line and Load Regulation

The line and load regulation data is measured after 10-minute aging. The voltage data is tested at the PCB terminal. All the data is tested at ambient temperature.

Table 4: Line and Load Regulation Data

AC input voltage	Loading(mA)						
	0	50	100	150	200	250	300
85Vac/60Hz	19.215	18.654	18.572	18.532	18.524	18.516	18.512
115Vac/60Hz	19.206	18.603	18.569	18.537	18.526	18.518	18.514
230Vac/50Hz	19.312	18.565	18.538	18.513	18.504	18.496	18.495
265Vac/50Hz	19.315	18.556	18.530	18.512	18.505	18.501	18.498
Line Regulation	±0.28%	±0.26%	±0.11%	±0.08%	±0.06%	±0.06%	±0.05%
AC input voltage	Loading(mA)					Load Regulation	CV Regulation
	350	400	450	500	550		
85Vac/60Hz	18.503	18.494	18.489	18.485	18.483	±1.94%	±4.05%
115Vac/60Hz	18.513	18.511	18.509	18.506	18.502	±1.87%	
230Vac/50Hz	18.493	18.492	18.491	18.489	18.488	±2.18%	
265Vac/50Hz	18.495	18.493	18.491	18.488	18.487	±2.19%	
Line Regulation	±0.05%	±0.05%	±0.06%	±0.06%	±0.05%	-	

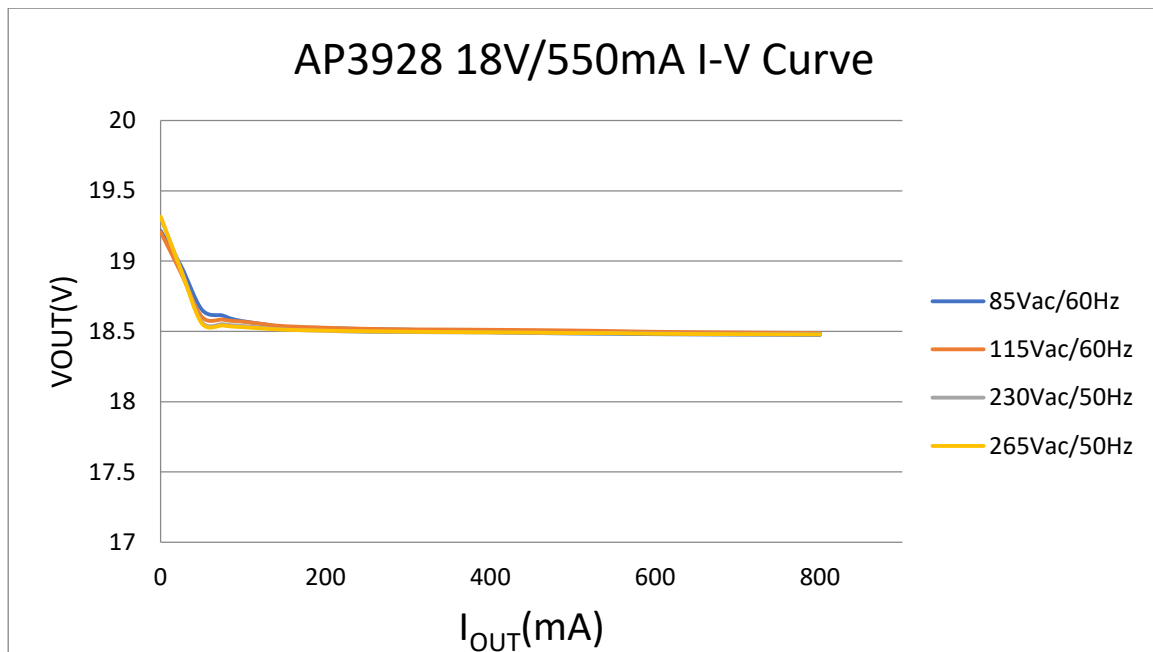

Figure 8: Output Voltage versus Loading Curve

5.2 Key Performance Test

5.2.1 Start-up Performance

The start-up time is measured with a differential probe across AC inputs, "L" and "N" connectors and a common low-voltage probe across output terminals, "+V" and "GND" connectors. Before starting up, buck capacitors should be discharged.

Table 5: Start-up Performance

AC input voltage	Loading conditions		Figures
	No load	Full load	
85Vac/60Hz	10.5ms	18.6ms	Fig. 9, Fig. 10
115Vac/60Hz	10.4ms	17.9ms	-
230Vac/50Hz	10.2ms	16.5ms	-
265Vac/50Hz	10.1ms	16.1ms	Fig. 11, Fig. 12

CH2:Vin; CH4:Vo

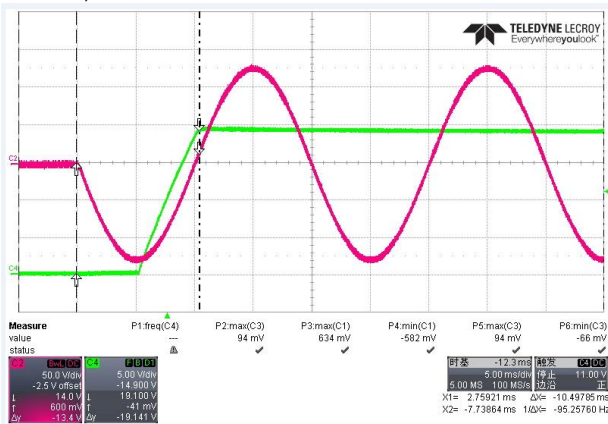

Figure 9: Start up time is 10.5ms @85Vac/60Hz, no load

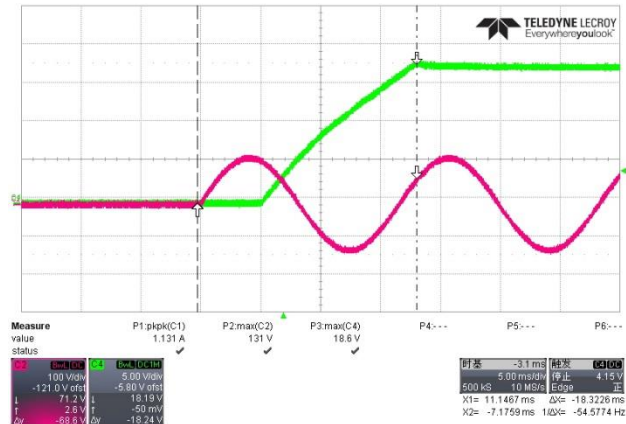

Figure 10: Start up time is 18.6ms @85Vac/60Hz, full load

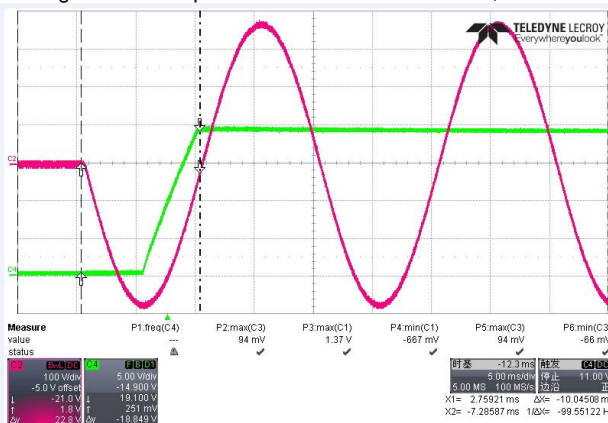

Figure 11: Start up time is 18.9ms @265Vac/50Hz, no load

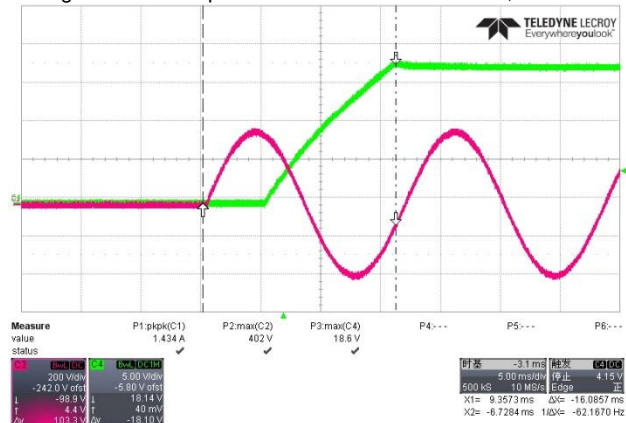

Figure 12: Start up time is 29.4ms @265Vac/50Hz, full load

5.2.2 Rise Time

The rise time is measured with a common low-voltage probe across output terminals, “+V” and “GND” connectors. Before starting up, output capacitors should be discharged.

Table 6: Rise Time

AC input voltage	Loading conditions		Figures
	No load	Full load	
85Vac/60Hz	5.3ms	12.7ms	Fig. 13, Fig.14
115Vac/50Hz	5.3ms	12.4ms	-
230Vac/50Hz	5.1ms	11.2ms	-
265Vac/50Hz	5.1ms	10.8ms	Fig. 15, Fig.16

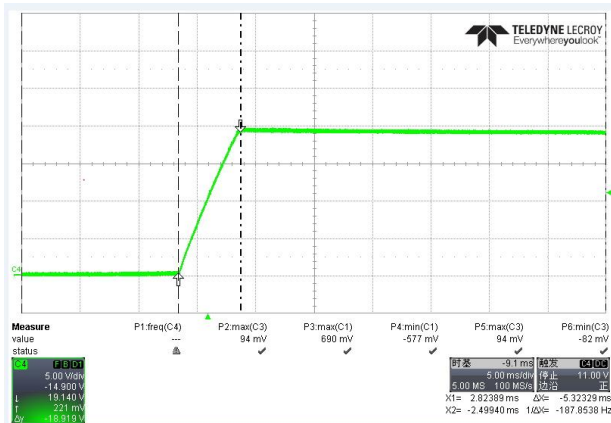

Fig. 13: Rise time is 5.3ms @85Vac/60Hz, no load

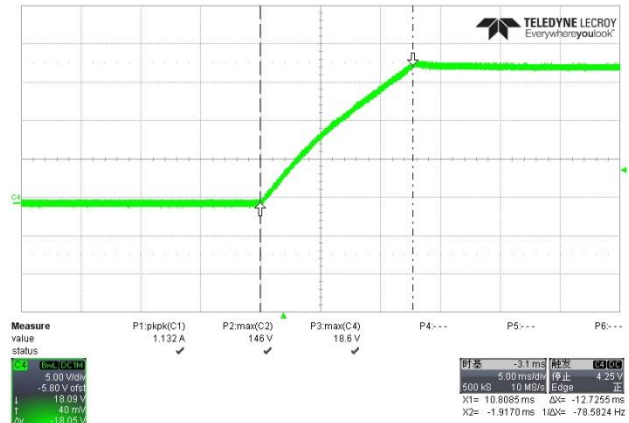

Fig 14: Rise time is 12.7ms @85Vac/60Hz, full load

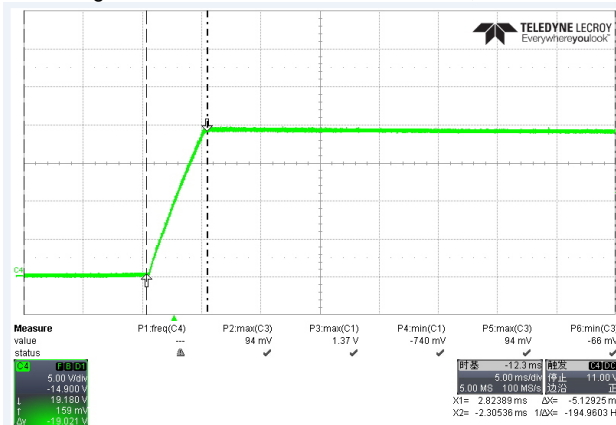

Figure 15: Rise time is 5.1ms @265Vac/50Hz, no load

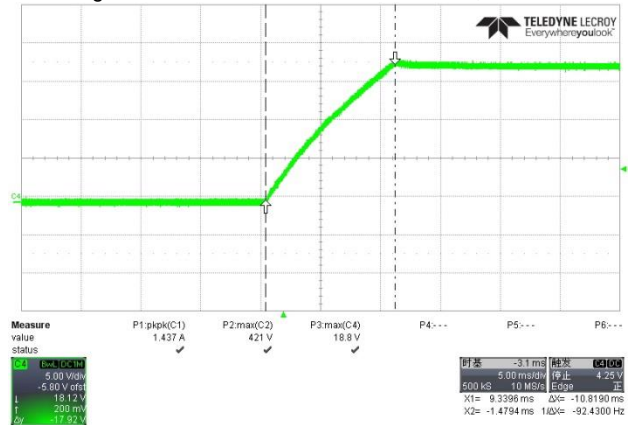

Figure 16: Rise time is 10.8ms @265Vac/50Hz, full load

5.2.3 Voltage Stress

The voltage is measured between the “Drain” and “S” pins of AP3928. The test needs differential probes.

Table 7: Internal MOSFET Drain-Source Voltage Stress

AC input voltage	Loading conditions		Figures
	No load	Full load	
85Vac/60Hz	139V	155V	Fig. 17, Fig 18
115Vac/60Hz	184V	197V	-
230Vac/50Hz	358V	364V	-
265Vac/50Hz	396V	438V	Fig. 19, Fig. 20

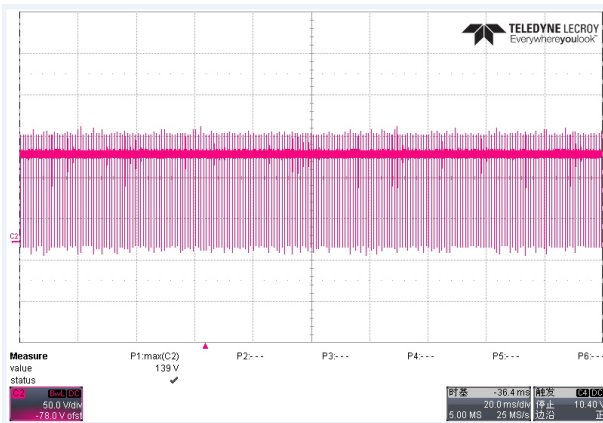

Figure 17: 139V@85Vac/60Hz, no load

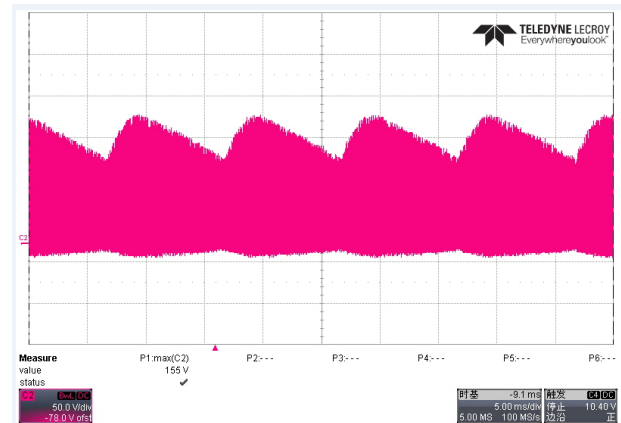

Figure 18: 155V@85Vac/60Hz, full load

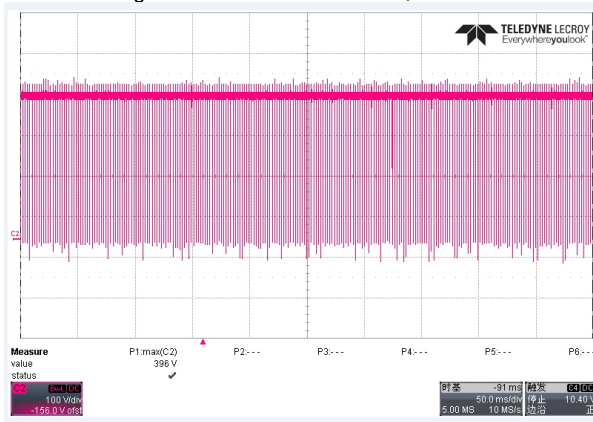

Figure 19: 396V@265Vac/50Hz, no load

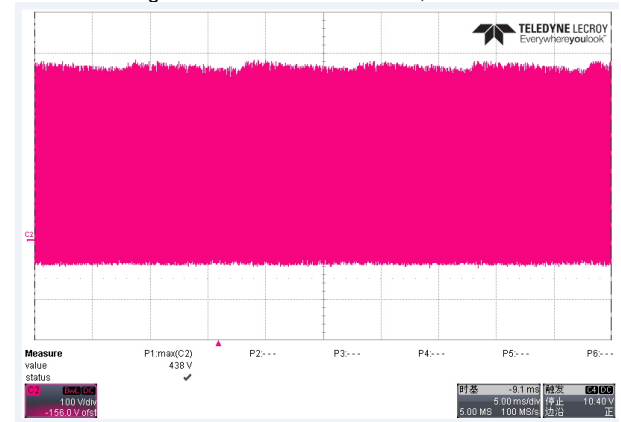

Figure 20: 438V@265Vac/50Hz, full load

5.2.4 Output Ripple & Noise

The ripple and noise is tested at PCB terminal, using 10:1 probe without probe cap and ground clip. The bandwidth is limited to 20MHz. A 10 μ F electrolytic capacitor and a 100nF ceramic capacitor should be paralleled to the output terminal.

Table 8: Ripple & Noise

AC input voltage	Loading conditions		Figures
	No load	Full load	
85Vac/60Hz	15.4mV	57.6mV	Fig. 21, Fig.22
115Vac/60Hz	25.5mV	56.9mV	-
230Vac/50Hz	27.8mV	55.2mV	-
265Vac/50Hz	29.7mV	55.7mV	Fig. 23, Fig. 24

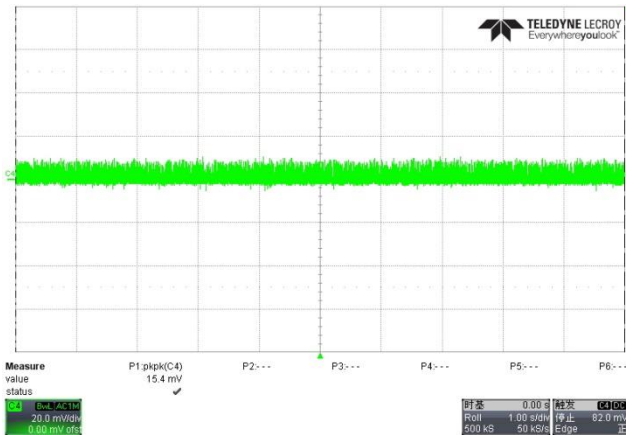

Figure 21: Output R&N, 15.4mV@85Vac/60Hz, no load,

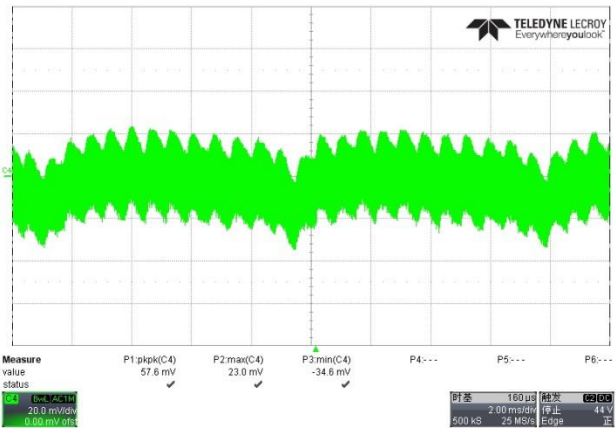

Figure 22: Output R&N, 57.6mV@85Vac/60Hz, full load,

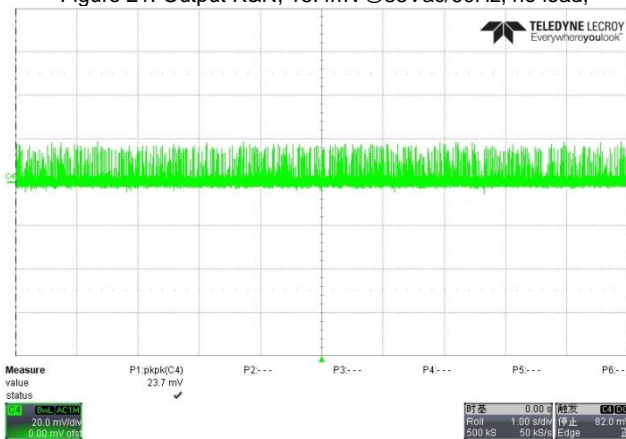

Figure 23: Output R&N, 29.7mV@265Vac/50Hz, no load

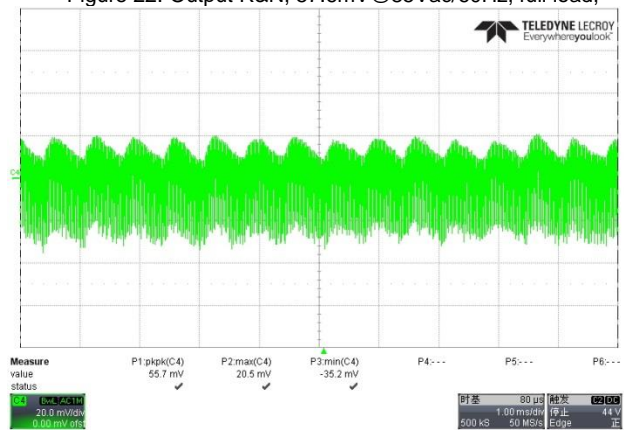

Figure 24: Output R&N, 55.7mV@265Vac/50Hz, full load

5.2.5 Dynamic Response

The dynamic response of output voltage is tested at the PCB terminal and the bandwidth is limited to 20MHz. Loading is set 0A as low load and 550mA as high load. Besides, the period is 2 seconds and the ramp is set at 250mA/μs.

Table 9: Dynamic Response

AC input voltage	Output voltage		Figures
	Max Vo(V)	Min Vo(V)	
85Vac/60Hz	19.1	14.5	Fig. 25
115Vac/60Hz	19.2	14.6	-
230Vac/50Hz	19.4	13.9	-
265Vac/50Hz	19.5	13.4	Fig. 26

CH1: Io; CH4: Vo

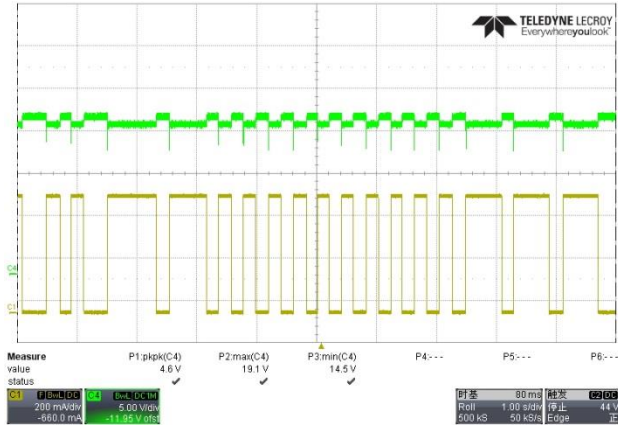

Figure 25: 14.5V~19.1V
@0~550mA,0.5s, 250mA/μs, 85Vac/60Hz

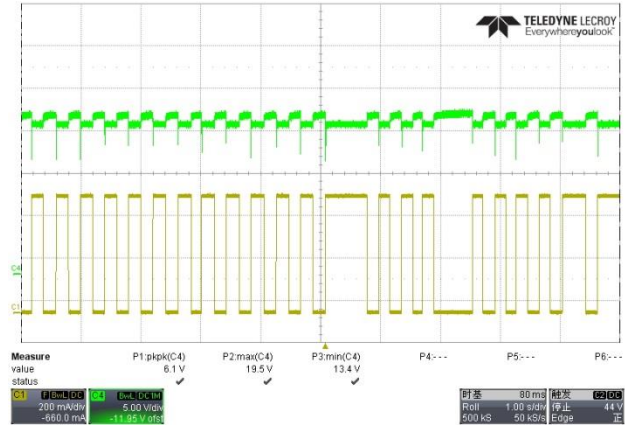

Figure 26: 13.4V~19.5V
@0~550mA,0.5s, 250mA/μs, 265Vac/50Hz

5.3 Protection Test

5.3.1 Short Circuit Protection (SCP) Test

The SCP test is measured under the condition that output cable terminals are shorted. The cable end short resistance value used is 50mΩ.

Table 10: Short Circuit Protection Test

AC input voltage	Max Vo (mV)	Max Io(mA)	Vds(V)	Average input power (W)	Figures
85Vac/60Hz	320	349	134	0.480	Fig. 27
115Vac/60Hz	320	364	179	0.698	-
230Vac/50Hz	448	694	352	0.442	-
265Vac/50Hz	448	777	404	0.234	Fig. 28

CH2: Vds; CH3 :Io; CH4: Vo

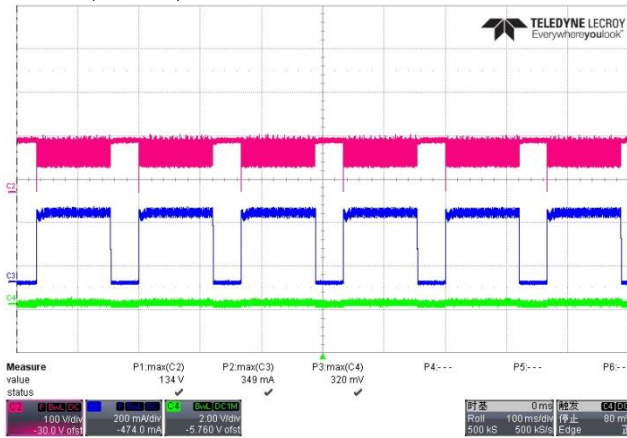

Figure 27: Output current, 349mA; output voltage, 320mV; Vds is 134V@output is shorted@85Vac/60Hz

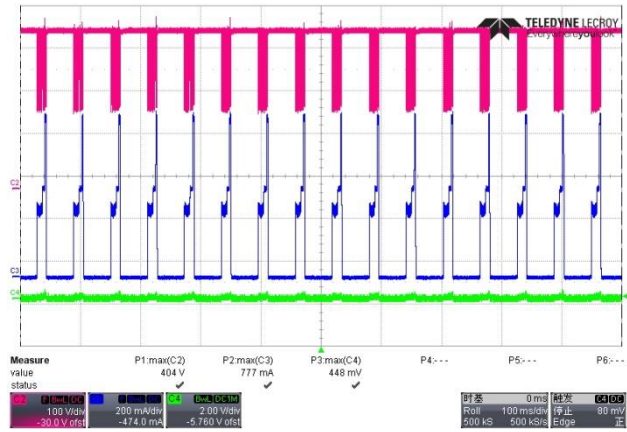

Figure 28: Output current, 777mA; output voltage, 448mV; Vds is 404V@output is shorted@265Vac/50Hz

5.3.2 Open Loop Detection (OLD) Protection Test

The open loop detection protection is measured when FB pin is connected to Source pin.

Table 11: Open Loop Detection Test

AC input voltage	The peak of output voltage(V)	Figures
85Vac/60Hz	3.01	Fig. 29
115Vac/60Hz	3.07	-
230Vac/50Hz	3.20	-
265Vac/50Hz	3.20	Fig. 30

CH2: Vds; CH3 :Io; CH4 :Vo

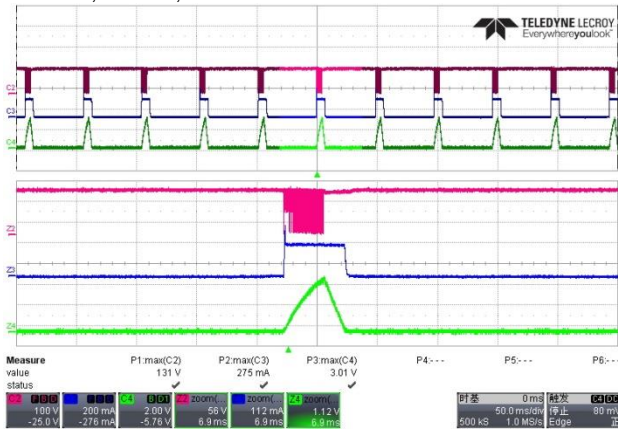

Fig. 29: Output voltage 3.01V@OLD, 85Vac/60Hz, full load

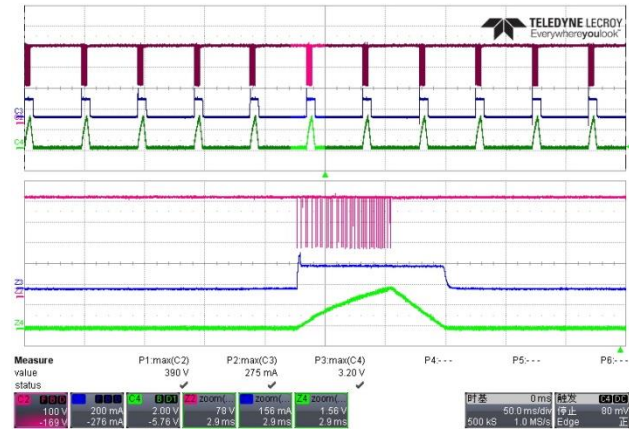

Fig. 30: Output voltage 3.20V@OLD, 265Vac/50Hz, full load

5.3.3 Overload Protection (OLP) Test

The overload protection point is tested as below: increase the loading by 10mA/step until the system cannot maintain a stable output, and then mark the loading level as over load protection point.

Table 12: Overload Protection Point test

AC input voltage	Overload protection point(mA)
85Vac/60Hz	750
115Vac/60Hz	750
230Vac/50Hz	750
265Vac/50Hz	750

5.4 Thermal Test

The thermal test is under ambient temperature after 1-hour aging. The board has no case in open frame. Thermal imager is used to observe the surface temperature of AP3928.

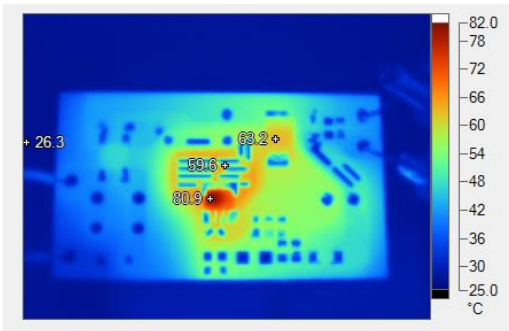

Figure 31: AP3928, 80.9°C, D2 63.2°C @85Vac/60Hz, full load, ambient temperature, 25°C.

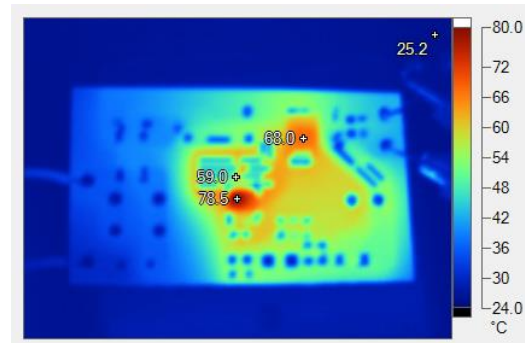

Figure 32: AP3928, 78.5°C, D2 68°C @ 265Vac/50Hz, full load, ambient temperature, 25°C.

5.5 System EMI Scan

The power supply meets EN55022 Class B (for 110Vac input and 230Vac input) EMI requirements with more than 6dB margin.

5.5.1 Conducted EMI Test of 230V@full load

The test result can pass EN55022 Class B limit with more than 6dB margin.

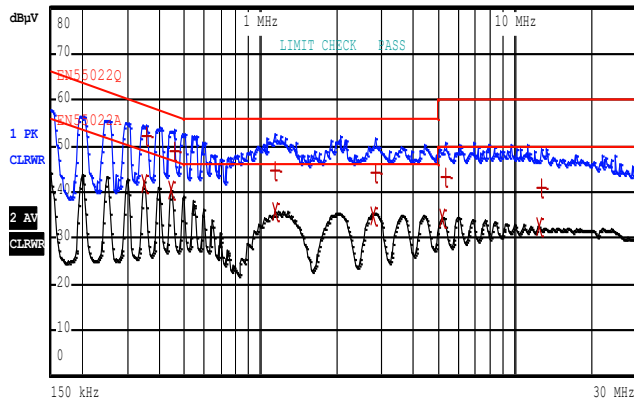

Fig. 33, L line conducted waveform@230Vac/50Hz, full load.

EDIT PEAK LIST (Final Measurement Results)				
Trace1:	EN55022Q			
Trace2:	EN55022A			
Trace3:	---			
TRACE	FREQUENCY	LEVEL dBμV	DELTA	
2 Average	346.008411606 kHz	42.00	-7.0	
1 Quasi Peak	352.963180679 kHz	52.13	-6.7	
2 Average	443.732257589 kHz	40.40	-6.5	
1 Quasi Peak	457.177788726 kHz	48.98	-7.7	
2 Average	1.13065507631 MHz	35.60	-10.3	
1 Quasi Peak	1.14196162708 MHz	44.82	-11.1	
2 Average	2.76855896362 MHz	34.99	-11.0	
1 Quasi Peak	2.82420699879 MHz	44.41	-11.5	
2 Average	5.18203480607 MHz	34.53	-15.4	
1 Quasi Peak	5.33905564273 MHz	43.29	-16.7	
2 Average	12.4388782936 MHz	32.46	-17.5	
1 Quasi Peak	12.6888997473 MHz	41.04	-18.9	

Fig. 34, L line conducted data@230Vac/50Hz, full load.

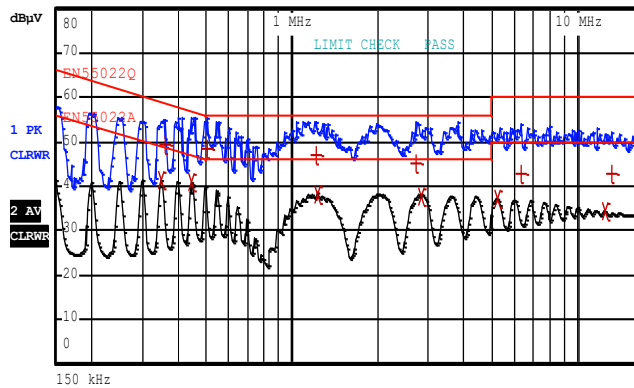

Figure 35: N line conducted waveform@230Vac/50Hz, full load.

EDIT PEAK LIST (Final Measurement Results)				
Trace1:	EN55022Q			
Trace2:	EN55022A			
Trace3:	---			
TRACE	FREQUENCY	LEVEL dBμV	DELTA	
2 Average	346.008411606 kHz	41.41	-7.0	
1 Quasi Peak	356.492812486 kHz	49.42	-9.0	
2 Average	443.732257589 kHz	40.96	-6.0	
1 Quasi Peak	500.008614528 kHz	48.48	-7.0	
1 Quasi Peak	1.21221527836 MHz	46.81	-9.0	
2 Average	1.22433743114 MHz	38.36	-7.0	
1 Quasi Peak	2.71400741459 MHz	45.33	-10.0	
2 Average	2.82420699879 MHz	37.87	-8.0	
2 Average	5.23385515413 MHz	37.17	-12.0	
1 Quasi Peak	6.32306725703 MHz	42.74	-17.0	
2 Average	12.4388782936 MHz	34.19	-15.0	
1 Quasi Peak	13.0733860985 MHz	42.97	-17.0	

Figure 36: N line conducted data@230Vac/50Hz, full load.

5.5.2 Conducted EMI Test of 110V@full load

The test result can pass EN55022 Class B limit with more than 6dB margin.

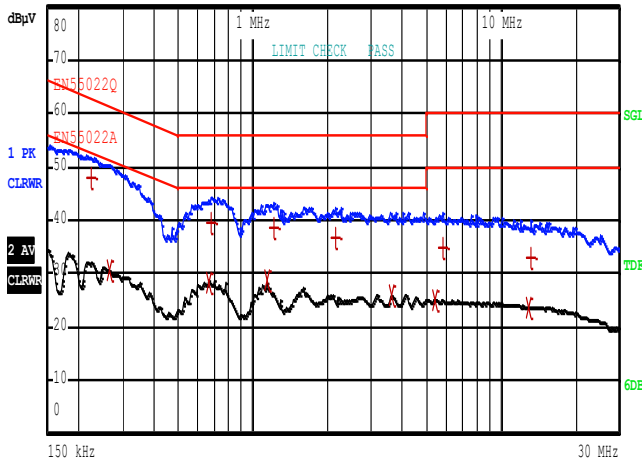

Figure 37: L line conducted waveform@110Vac/60Hz, full load.

EDIT PEAK LIST (Final Measurement Results)			
Trace1:	EN55022Q		
Trace2:	EN55022A		
Trace3:	---		
TRACE	FREQUENCY	LEVEL dBµV	DELTA LIMIT dB
1 Quasi Peak	221.118376275 kHz	47.97	-14.80
2 Average	264.49018761 kHz	30.76	-20.52
2 Average	660.656865747 kHz	28.35	-17.64
1 Quasi Peak	673.936068749 kHz	39.44	-16.56
2 Average	1.13065507631 MHz	28.56	-17.43
1 Quasi Peak	1.21221527836 MHz	38.78	-17.21
1 Quasi Peak	2.1374603093 MHz	36.76	-19.23
2 Average	3.6218534158 MHz	25.73	-20.26
2 Average	5.39244619915 MHz	24.87	-25.12
1 Quasi Peak	5.83924652649 MHz	34.64	-25.35
2 Average	12.8157887448 MHz	23.83	-26.16
1 Quasi Peak	13.0733860985 MHz	33.12	-26.87

Figure 38: L line conducted data@110Vac/60Hz, full load.

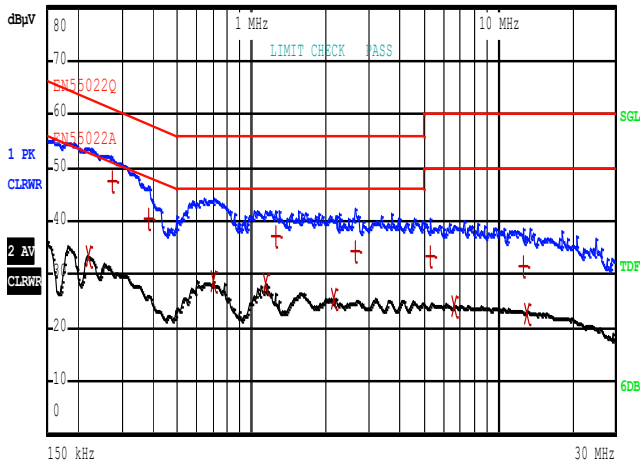

Figure 39: N line conducted waveform@110Vac/60Hz, full load.

EDIT PEAK LIST (Final Measurement Results)			
Trace1:	EN55022Q		
Trace2:	EN55022A		
Trace3:	---		
TRACE	FREQUENCY	LEVEL dBµV	DELTA LIMIT dB
2 Average	216.761470714 kHz	33.49	-19.44
1 Quasi Peak	272.504504785 kHz	47.46	-13.57
1 Quasi Peak	382.208547038 kHz	40.61	-17.61
2 Average	694.357005568 kHz	28.86	-17.13
2 Average	1.13065507631 MHz	28.30	-17.69
1 Quasi Peak	1.2489466135 MHz	37.25	-18.74
2 Average	2.1374603093 MHz	25.31	-20.68
1 Quasi Peak	2.634188858 MHz	34.41	-21.58
1 Quasi Peak	5.28619370567 MHz	33.38	-26.62
2 Average	6.57980914316 MHz	24.15	-25.84
1 Quasi Peak	12.5632670765 MHz	31.55	-28.44
2 Average	12.9439466322 MHz	22.89	-27.11

Figure 40: N line conducted data@110Vac/60Hz, full load.

IMPORTANT NOTICE

1. DIODES INCORPORATED AND ITS SUBSIDIARIES (“DIODES”) MAKE NO WARRANTY OF ANY KIND, EXPRESS OR IMPLIED, WITH REGARDS TO ANY INFORMATION CONTAINED IN THIS DOCUMENT, INCLUDING, BUT NOT LIMITED TO, THE IMPLIED WARRANTIES OF MERCHANTABILITY, FITNESS FOR A PARTICULAR PURPOSE OR NON-INFRINGEMENT OF THIRD PARTY INTELLECTUAL PROPERTY RIGHTS (AND THEIR EQUIVALENTS UNDER THE LAWS OF ANY JURISDICTION).
2. The Information contained herein is for informational purpose only and is provided only to illustrate the operation of Diodes products described herein and application examples. Diodes does not assume any liability arising out of the application or use of this document or any product described herein. This document is intended for skilled and technically trained engineering customers and users who design with Diodes products. Diodes products may be used to facilitate safety-related applications; however, in all instances customers and users are responsible for (a) selecting the appropriate Diodes products for their applications, (b) evaluating the suitability of the Diodes products for their intended applications, (c) ensuring their applications, which incorporate Diodes products, comply the applicable legal and regulatory requirements as well as safety and functional-safety related standards, and (d) ensuring they design with appropriate safeguards (including testing, validation, quality control techniques, redundancy, malfunction prevention, and appropriate treatment for aging degradation) to minimize the risks associated with their applications.
3. Diodes assumes no liability for any application-related information, support, assistance or feedback that may be provided by Diodes from time to time. Any customer or user of this document or products described herein will assume all risks and liabilities associated with such use, and will hold Diodes and all companies whose products are represented herein or on Diodes’ websites, harmless against all damages and liabilities.
4. Products described herein may be covered by one or more United States, international or foreign patents and pending patent applications. Product names and markings noted herein may also be covered by one or more United States, international or foreign trademarks and trademark applications. Diodes does not convey any license under any of its intellectual property rights or the rights of any third parties (including third parties whose products and services may be described in this document or on Diodes’ website) under this document.
5. Diodes products are provided subject to Diodes’ Standard Terms and Conditions of Sale (<https://www.diodes.com/about/company/terms-and-conditions/terms-and-conditions-of-sales/>) or other applicable terms. This document does not alter or expand the applicable warranties provided by Diodes. Diodes does not warrant or accept any liability whatsoever in respect of any products purchased through unauthorized sales channel.
6. Diodes products and technology may not be used for or incorporated into any products or systems whose manufacture, use or sale is prohibited under any applicable laws and regulations. Should customers or users use Diodes products in contravention of any applicable laws or regulations, or for any unintended or unauthorized application, customers and users will (a) be solely responsible for any damages, losses or penalties arising in connection therewith or as a result thereof, and (b) indemnify and hold Diodes and its representatives and agents harmless against any and all claims, damages, expenses, and attorney fees arising out of, directly or indirectly, any claim relating to any noncompliance with the applicable laws and regulations, as well as any unintended or unauthorized application.
7. While efforts have been made to ensure the information contained in this document is accurate, complete and current, it may contain technical inaccuracies, omissions and typographical errors. Diodes does not warrant that information contained in this document is error-free and Diodes is under no obligation to update or otherwise correct this information. Notwithstanding the foregoing, Diodes reserves the right to make modifications, enhancements, improvements, corrections or other changes without further notice to this document and any product described herein. This document is written in English but may be translated into multiple languages for reference. Only the English version of this document is the final and determinative format released by Diodes.
8. Any unauthorized copying, modification, distribution, transmission, display or other use of this document (or any portion hereof) is prohibited. Diodes assumes no responsibility for any losses incurred by the customers or users or any third parties arising from any such unauthorized use.

Copyright © 2021 Diodes Incorporated

www.diodes.com