

# SERPAC 2010, DB25 for A27

Electronic Enclosures

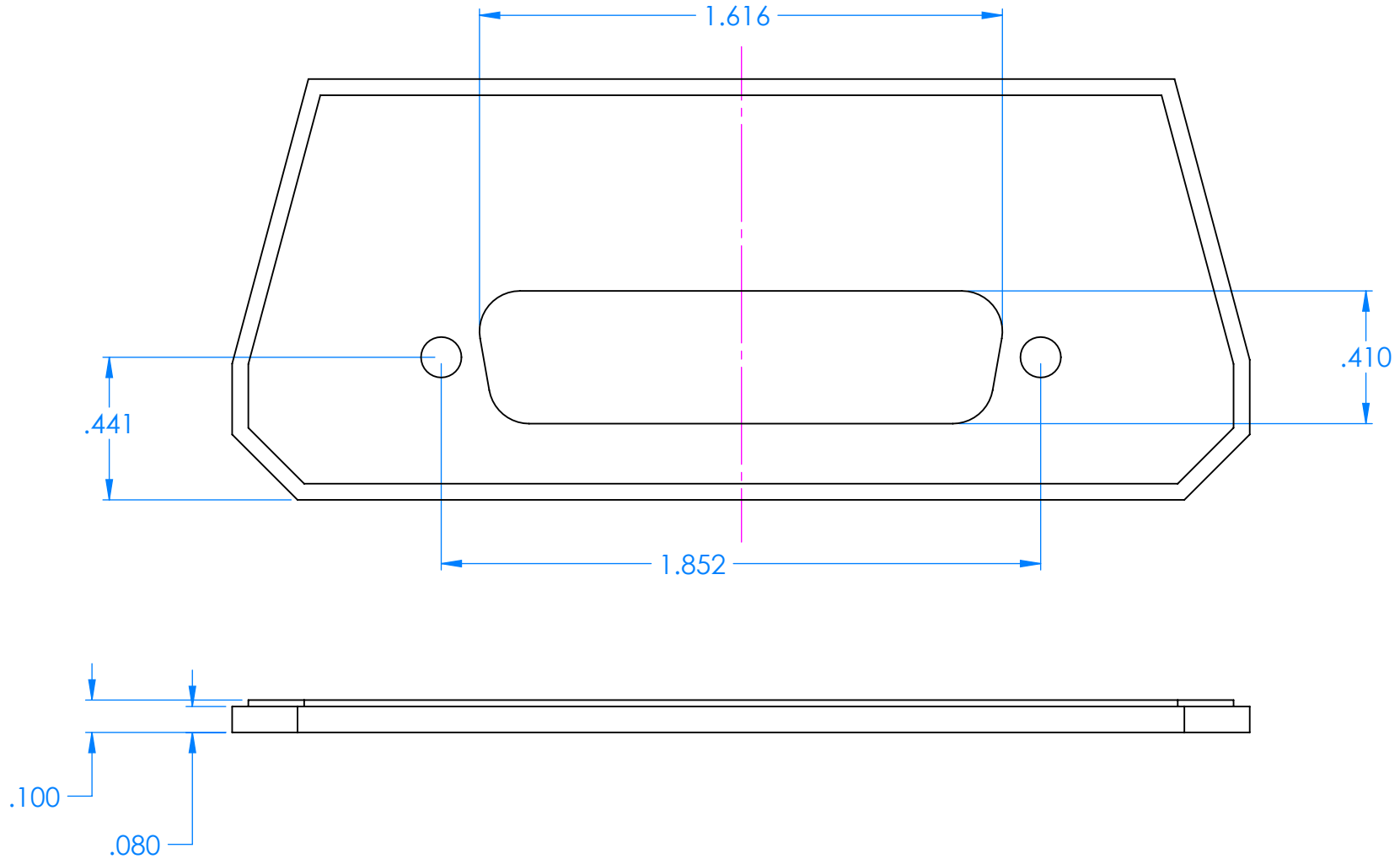

## NOTES:

Cutout located to accept a D-sub standard surface mount DB25 connector (male or female) using a .065" thick circuit board.