

Housing - HC-EVO-B24-SHFDC-2SSM32-PLRBK - 1421380

Please be informed that the data shown in this PDF Document is generated from our Online Catalog. Please find the complete data in the user's documentation. Our General Terms of Use for Downloads are valid (<http://phoenixcontact.com/download>)



Box mounting bases B24, for double locking latch, material: PA, protective cover material: PA, cable outlets: 2, lateral, height: 84 mm, cable gland: none, support sleeve: no, 2x M32, protective cover: yes, Standard, including 2x reducing adapter

Your advantages

- ✓ Lower costs than metal version
- ✓ Low weight
- ✓ Lower risk of condensation
- ✓ Both contact insert PE sheets are connected by means of a metal frame integrated in the sleeve housing
- ✓ Metal inlays ensure leading PE contact with angled plugs
- ✓ Completely corrosion-resistant
- ✓ Halogen-free plastic
- ✓ Marking label can be attached



Key Commercial Data

Packing unit	1 pc
GTIN	
GTIN	4055626264974

Technical data

Dimensions

Height	84 mm
Width	57 mm
Length	144 mm

Ambient conditions

Degree of protection (IP)	IP66 (when plugged in)
	IP54 (with closed protective cover)
Degree of protection (NEMA)	12 (UL 50e)
Ambient temperature (operation)	-40 °C ... 125 °C

Housing - HC-EVO-B24-SHFDC-2SSM32-PLRBK - 1421380

Technical data

General

Note	For contact inserts HC-B24, BB46, D64, DD108, M, K, HV10-I-PT, HV 10-E...C
Size	B24
Housing type	Box mounting bases
Color	black
Locking type	for double locking latch
No. of cable outlets	2
Cable outlet	lateral
Screw connection	none
Type of the screw connection	2x M32
Protective cover	yes
Housing material	PA
Seal material	NBR
Material, protective cover	PA
Flammability rating according to UL 94	V0
Assembly instructions	Two plastic reductions M40 to M32 are provided
Connection	One of the two openings for the screw connections is sealed but can be broken open using a screwdriver.

Standards and Regulations

Flammability rating according to UL 94	V0
--	----

Environmental Product Compliance

China RoHS	Environmentally Friendly Use Period = 50
	For details about hazardous substances go to tab "Downloads", Category "Manufacturer's declaration"

Drawings

Housing - HC-EVO-B24-SHFDC-2SSM32-PLRBK - 1421380

Dimensional drawing

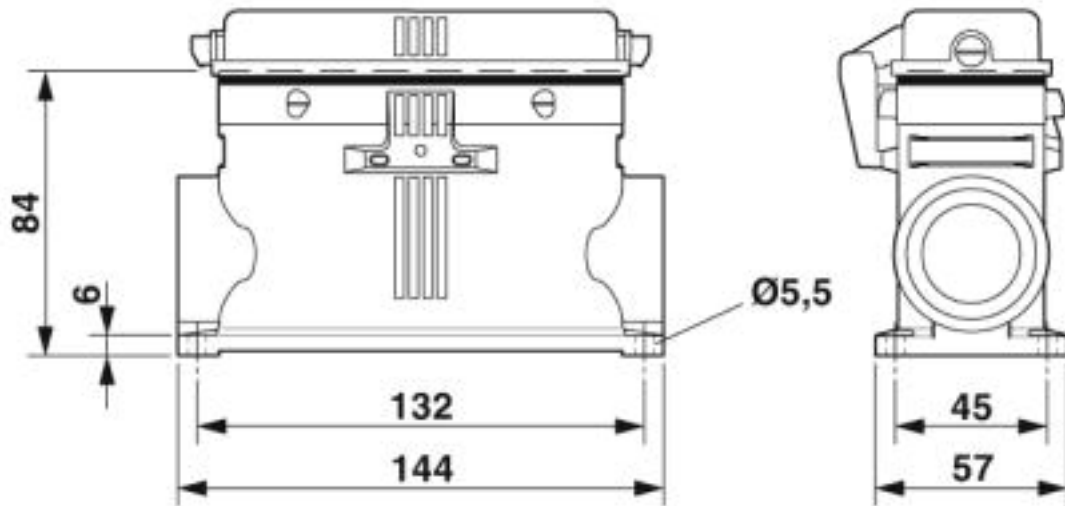

Dimensional drawing

Approvals

Approvals

Approvals

EAC / DNV GL

Ex Approvals

Approval details

EAC		RU C- DE.AI30.B.01102
-----	--	--------------------------

DNV GL		https://approvalfinder.dnvgl.com/	TAE000037S
--------	--	---	------------

Phoenix Contact 2019 © - all rights reserved
<http://www.phoenixcontact.com>

PHOENIX CONTACT GmbH & Co. KG
Flachmarktstr. 8
32825 Blomberg
Germany
Tel. +49 5235 300
Fax +49 5235 3 41200
<http://www.phoenixcontact.com>