

NCP1611GEVB

160-W, Wide Mains, PFC Stage Driven by the NCP1611 Evaluation Board User's Manual



ON Semiconductor®

<http://onsemi.com>

EVAL BOARD USER'S MANUAL

Introduction

Housed in a SO-8 package, The NCP1611 is designed to drive PFC boost stages in so-called Current Controlled Frequency Fold-back (CCFF). In this mode, the circuit classically operates in Critical conduction Mode (CrM) when the inductor current exceeds a programmable value. When the current is below this preset level, the NCP1611 linearly decays the frequency down to about 20 kHz when the current is nearly zero. CCFF maximizes the efficiency throughout the load range. Incorporating protection features for rugged operation, it is furthermore ideal in systems where cost-effectiveness, reliability, low stand-by power and high-efficiency are the key requirements.

Extremely slim, the NCP1611 evaluation board is designed to be less than 13 mm high. This low-profile PFC

stage is intended to deliver 160 W under a 390 V output voltage from a wide mains input. This is a PFC boost converter as used in Flat TVs, High Power LED Street Light power supplies, and all-in-one computer supplies. The evaluation board embeds the NCP1611 B-version which is best appropriate for the self-biased configuration. The board is also configurable to have the NCP1611 powered from an external power source. In this case, apply a V_{CC} voltage that exceeds the NCP1611B start-up level (18.2 V max) to ensure the circuit start of operation or solder the NCP1611A instead. The A-version start-up level is lower than 11.25 V to allow the circuit powering from a 12 V rail. Both versions feature a large V_{CC} operating range (from 9.5 V up to 35 V).

Table 1. ELECTRICAL SPECIFICATIONS

Description	Value	Units
Input Voltage Range	90-265	Vrms
Line Frequency Range	45 to 66	Hz
Output Power	160	W
Minimum Output Load Current(s)	0	Adc
Number of Outputs	1	
Nominal Output Voltage	390	Vdc
Maximum Startup Time	< 3	s
No-Load Power (115 V _{rms})	< 250	mW
Target Efficiency at Full Load (115 V _{rms})	95	%
Load Conditions For Efficiency Measurements (10%, 20%,...)	10-100	%
Minimum Efficiency At 20% Load, 115 V _{rms}	93	%
Minimum PF Over The Line Range At Full Load	95	%
Hold-Up Time (the output voltage remaining above 300 V)	> 10	ms
Peak To Peak Low Frequency Output Ripple	< 8	%

NCP1611GEVB

THE BOARD

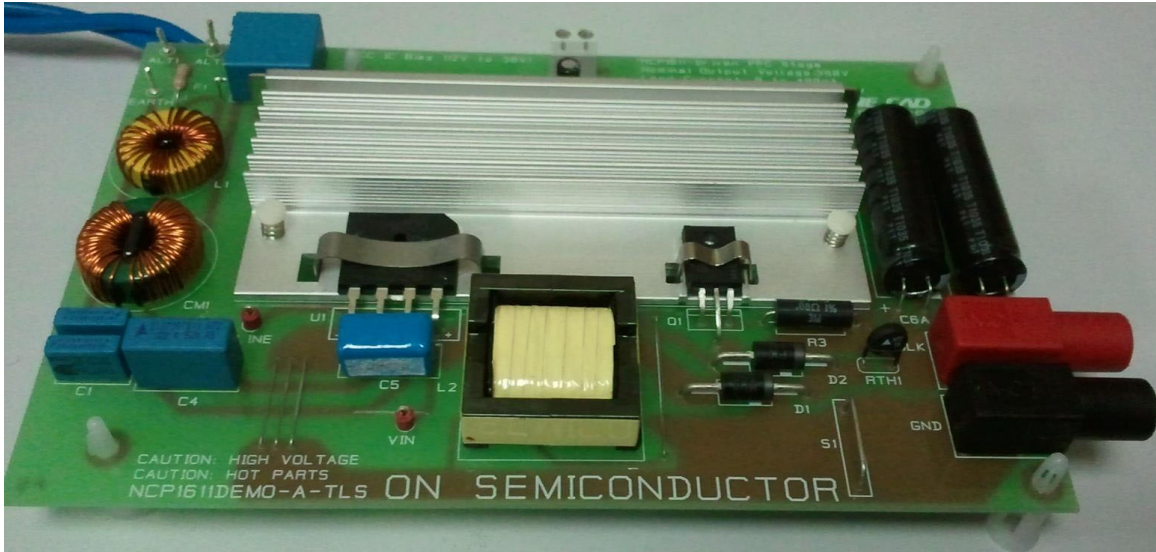

Figure 1. A Slim Board (Height < 13 mm)

APPLICATION SCHEMATIC

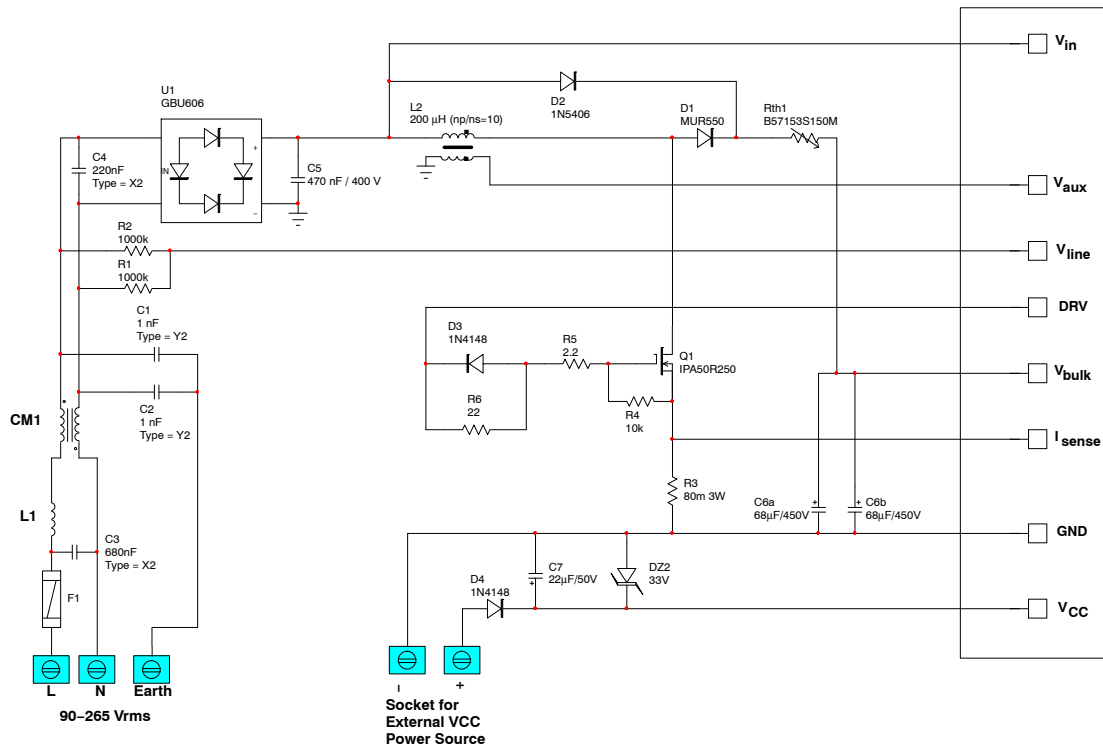

Figure 2. Application Schematic – Power Section

If an external V_{CC} is applied to the board (as allowed by the socket for external V_{CC} power source), it must be less

than 33 V not to exceed the reverse ZENER voltage of ZENER diode DZ_2 of Figure 2.

NCP1611GEVB

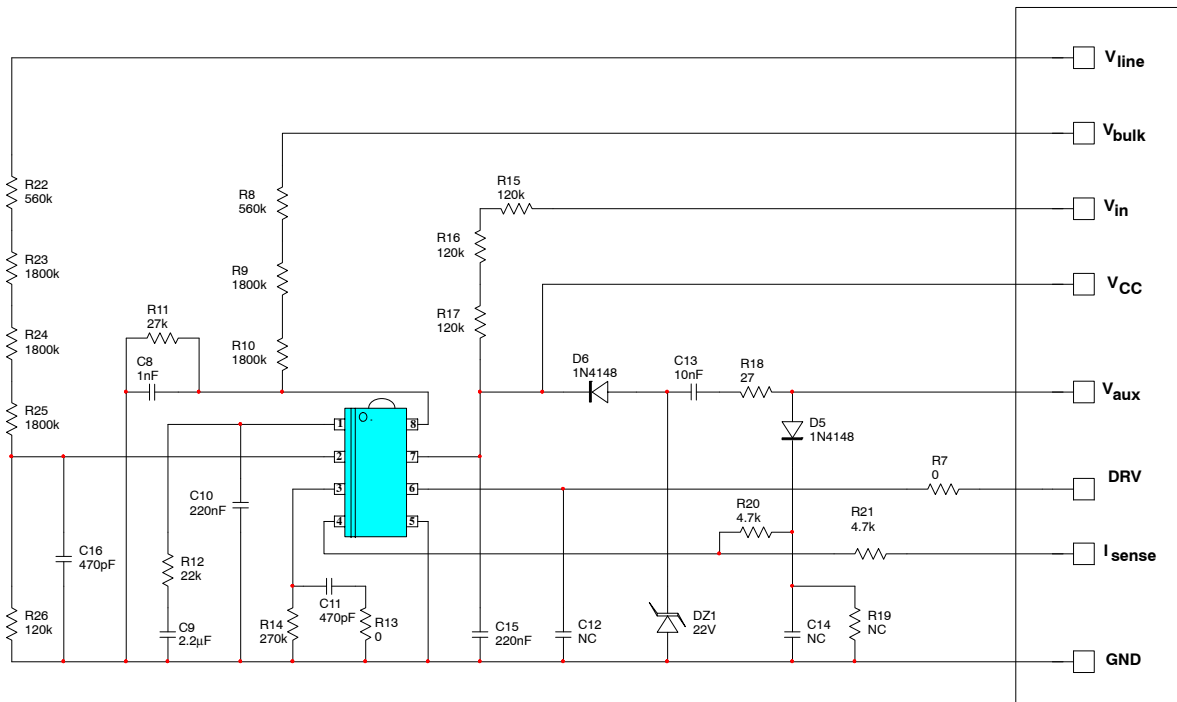
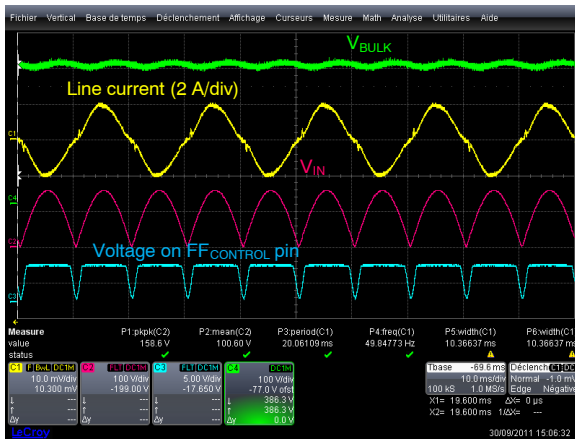
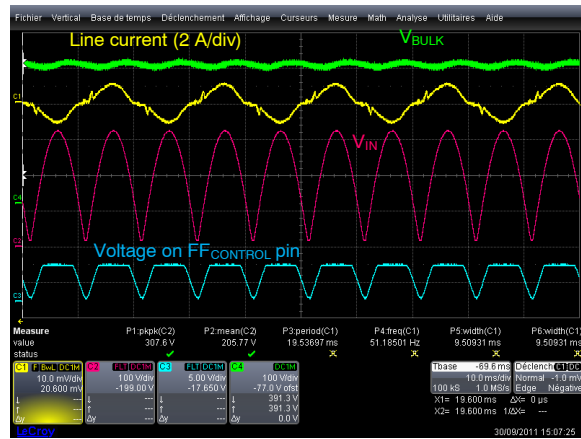

Figure 3. Application Schematic – Control Section

GENERAL BEHAVIOR – TYPICAL WAVEFORMS



a.) 115 V



a.) 230 V

Figure 4. General Waveforms at Full Load

CCFF Operation

The NCP1611 operates in so called Current Controlled Frequency Fold-back (CCFF) where the circuit operates in Critical conduction Mode (CrM) when the instantaneous line current is medium or high. When this current is lower than a preset level, the frequency linearly decays to about 20 kHz. CCFF maximizes the efficiency at both nominal and light loads (*). In particular, stand-by losses are minimized.

To further optimize the efficiency, the circuit skips cycles near the line zero crossing where the power transfer is particularly inefficient. This is at the cost of some current distortion. If superior power factor is needed, forcing a minimum 0.75 V voltage on the “FFcontrol” inhibits this function.

*Like in FCCrM controllers, internal circuitry allows near-unity power factor even when the switching frequency is reduced.

NCP1611GEVB

Practically, the FFcontrol pin of the NCP1611 generates a voltage representative of the instantaneous line current. When this voltage exceeds 2.5 V, the circuit operates in CrM. If the FFcontrol voltage is below 2.5 V, the circuit forces a delay (or dead-time) before re-starting a DRV cycle which

is proportional to the difference between 2.5 V reference and the FFcontrol voltage. This delay is maximum when the FFcontrol voltage is 0.75 V (about 45 μ s) so that a nearly 20 kHz operation is obtained. Below this 0.75 V level, the circuit skips cycles.

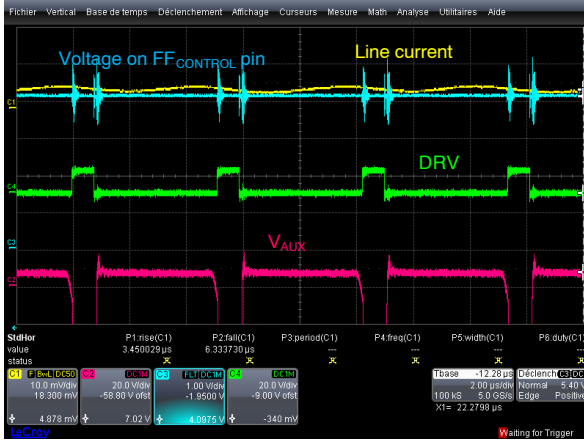

a) CrM operation at the top of the sinusoid



b) Reduced frequency at a lower level of the sinusoid

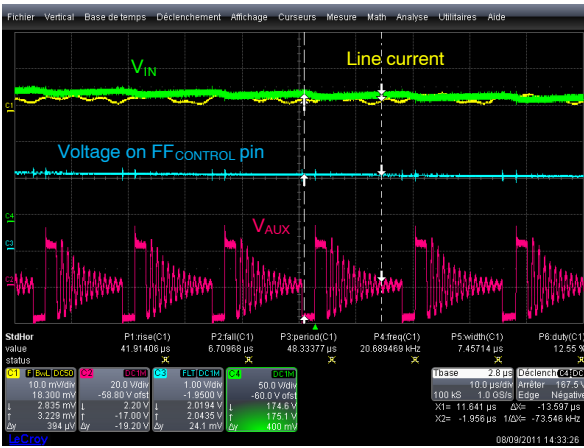

c) Low frequency near the line zero crossing

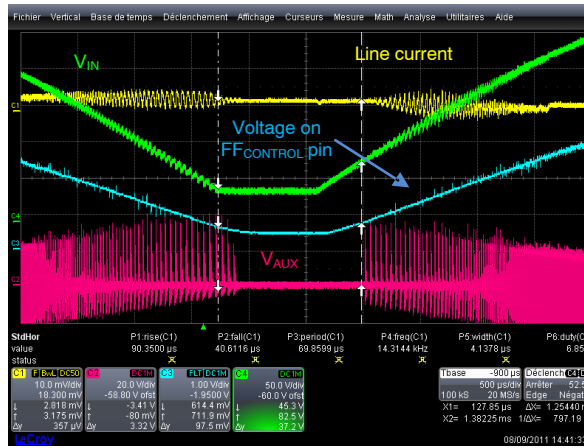

d) Skip cycle at the line zero crossing

Figure 5. CCFF operation (230 V, 0.2 A Load Current)

Figure 5 illustrates the CCFF operation at 230 V, 200 mA loading the PFC stage:

1. At the top of the sinusoid, the FFcontrol pin voltage (that is representative of the line current) exceeds 2.5 V and the circuit operates in critical conduction mode.
2. As the input voltage decays, so do the line current and the FFcontrol pin voltage. The FFcontrol being lower than 2.5 V, the circuit starts to reduce the frequency. In this figure, we can note that the circuit nicely transitions from a 3rd valley turning on to 4th valley turning on. This is one of the CCFF merits, the system is “locked” on to valley n until it needs to jump to valley (n-1) or valley (n+1). In other words, there is no inappropriate transitions between two valleys
3. Near the zero crossing the frequency is further decreased

4. At the line zero crossing, the circuit skips cycle when the FFcontrol pin voltage goes below 0.65 V and resumes when the FFcontrol pin voltage exceeds 0.75 V.

In all cases, the circuit turns on at a valley:

- Classical valley turn on in CrM operation
- At the first valley following the completion of the dead-time generated by the CCFF function to reduce the frequency.

One can also note that the switching frequency being less when the line current is low, the frequency is particularly low at light load, high line, CrM operation being more likely to occur at heavy load, low line. Experience shows that such a behaviour helps optimize the efficiency in conditions.

NCP1611GEVB

Similarly, the skipping period of time (near the line zero crossing) visible in Figure 9 (for the particular case of the operation at 265 V and 25% of the load):

- Is very short at low line, heavy load
- Is longer when the load diminishes and the line magnitude

Let us remind that the skip function optimizes the efficiency but this is at the cost of a limited current distortion. If superior power factor is needed, forcing a minimum 0.75 V voltage on the “FFcontrol” pin inhibits this function.

Refer to the data sheet for a detailed explanation of the CCF operation and of its implementation in the NCP1611 [3].



a) Soft Skip Beginning

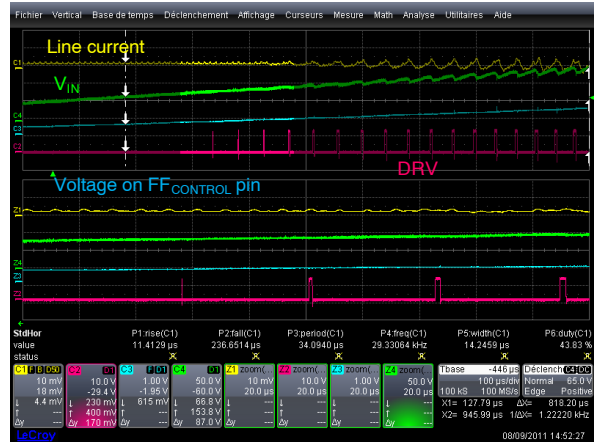

b) Soft Operation Recovery

Figure 6. The NCP1611 Enters and Leaves Skip Mode in a Soft Manner

As illustrated by Figure 8, the circuit does not abruptly interrupt the switching when it enters skip mode. Instead, the on-time is gradually decreased to zero in 3 to 4 switching

periods typically. Similarly, the circuit recovers operation in a soft manner.

POWER FACTOR AND EFFICIENCY

The NCP1611 evaluation board embeds a NTC to limit the in-rush current that takes place when the PFC stage is plugged in. The NTC placed in series with the boost diode. This location is rather optimum in term of efficiency since it is in the in-rush current path at a place where the rms

current is less compared to the input side. However, this component still consumes some power. That is why the efficiency is given with the NTC and with the NTC being shorted.

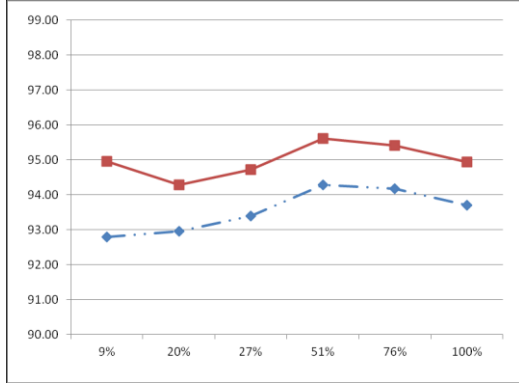

Efficiency at 90 V

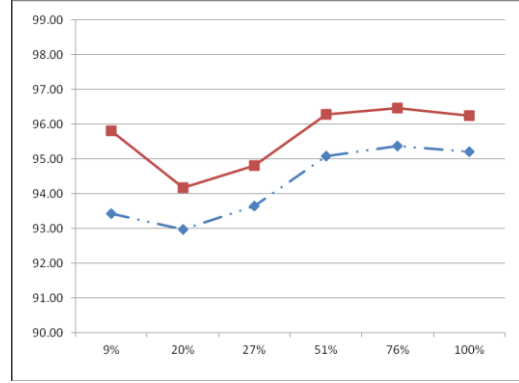

Efficiency at 115 V

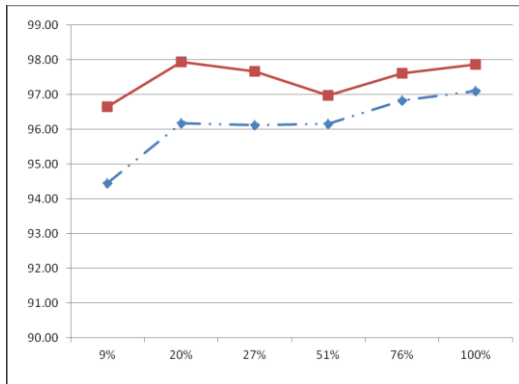

Efficiency at 230 V

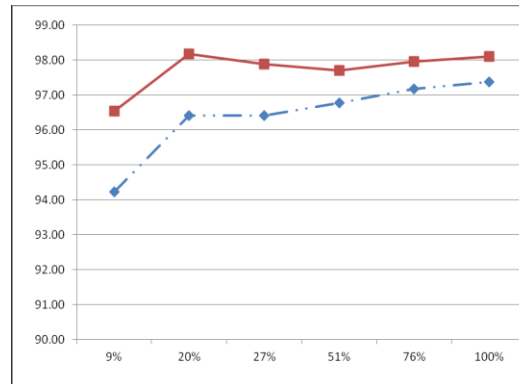

Efficiency at 265 V

Figure 7. Efficiency versus Load of the Evaluation Board (blue dotted line), of the Evaluation Board where the NTC is shorted (red solid line)

Figure 7 displays the efficiency versus load at different line levels. When considering efficiency versus load, we generally think of the traditional bell-shaped curves:

- At low line, the efficiency peaks somewhere at a medium load and declines at full load as a result of the conduction losses and at light load due to the switching losses.
- At high line, the conduction losses being less critical, efficiency is maximal at or near the maximum load point and decays when the power demand diminishes because the increasing impact of the switching losses.

Curves of Figure 7 meet this behavior in the right-hand side where our demo-board resembles a traditional CrM

PFC stage. In the left-hand side, the efficiency normally drops because of the switching losses until an inflection point where it rises up again as a result of the CCF operation. As previously detailed, CCF makes the switching frequency decay linearly as a function of the instantaneous line current when it goes below a preset level. As detailed in [1], the CCF threshold is set to 17% of the line maximum current. Hence, the PFC circuit switching frequency is permanently reduced when the power is below 17% of its maximum level @ 90 V and below about 50% @ 265 V. That is why the aforementioned inflection point is around 20% of the load at low line and 50% of the load at high line, as confirmed by the curves of Figure 8.

Efficiency comparison to a traditional CrM operation.

3 V have been forced on the FFcontrol pin of the NCP1611 so that the circuit CCFE function is disabled. Hence, the PFC stage operates in a traditional critical conduction mode (CrM) in all conditions. Figure 8 compares the efficiency with CCFE (demo-board) to that without CCFE. Otherwise said, CCFE operation is compared to the traditional critical mode solution.

As expected, as long as the switching frequency is not significantly reduced by CCFE, that is above 20% load at low line and above 50% at high line (see previous section), the CCFE and CrM curves matches. At lighter loads, the efficiency is much improved with CCFE.

Let's remind that CCFE works as a function of the instantaneous line current: when the signal representative of the line current (generated by the FFcontrol pin) is lower than 2.5 V, the circuit reduces the switching frequency. This is the case near the line zero crossing whatever the load is. Hence, the switching frequency reduces at the lowest values of the line sinusoid even in heavy load conditions. That is why the efficiency is also improved the load is high. This is particularly true at high line where CCFE has more effect than at low line since the line current is less.

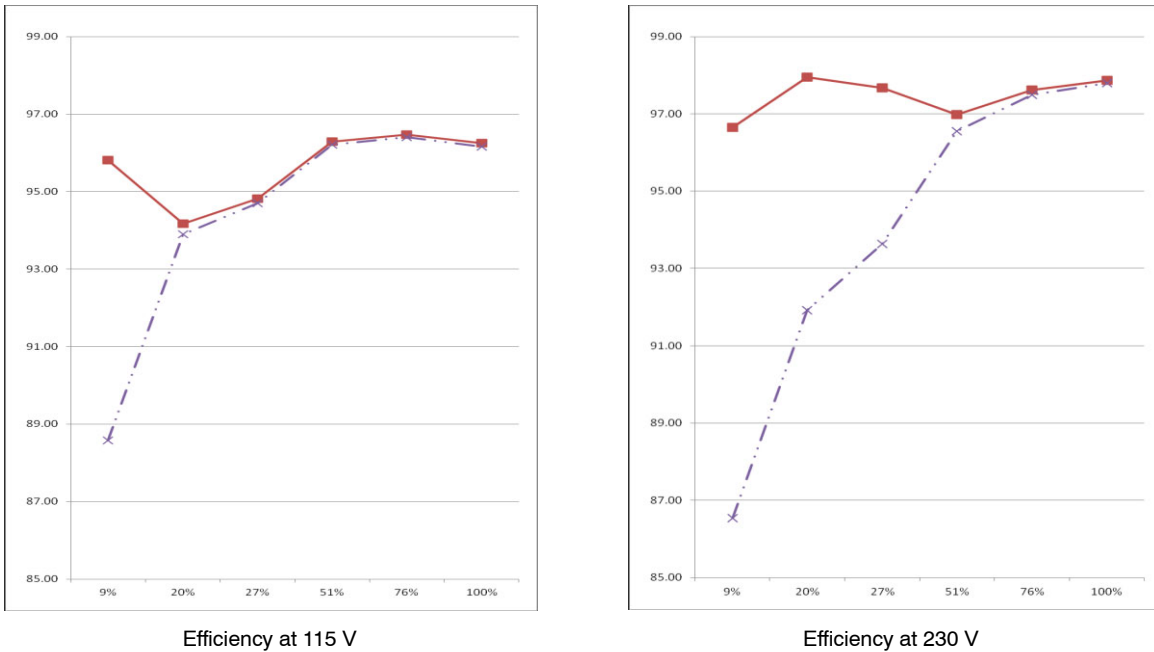

Figure 8. Efficiency versus Load of the Evaluation Board (red solid line), of the Evaluation Board Operated in Full CrM (purple dotted line). In both Cases, the NTC is Shorted.

Skip Mode

When the instantaneous line current tends to be very low (below about 5% of its maximum level in our application – refer to [1]), the circuit enters a skip cycle mode. In another words, the circuit stops operating at a moment when the power transfer is particularly inefficient.

This improves the efficiency in light load as shown by Figure 10. The dotted line portrays the efficiency when skip

mode is inhibited by forcing a 0.75 V minimum voltage on the FFcontrol pin. The efficiency is improved below 20 % of the load at low line while some benefit is visible starting from 50% of the load at 230 V.

As it will be shown, PF is slightly affected by the skip mode function.

NCP1611GEVB

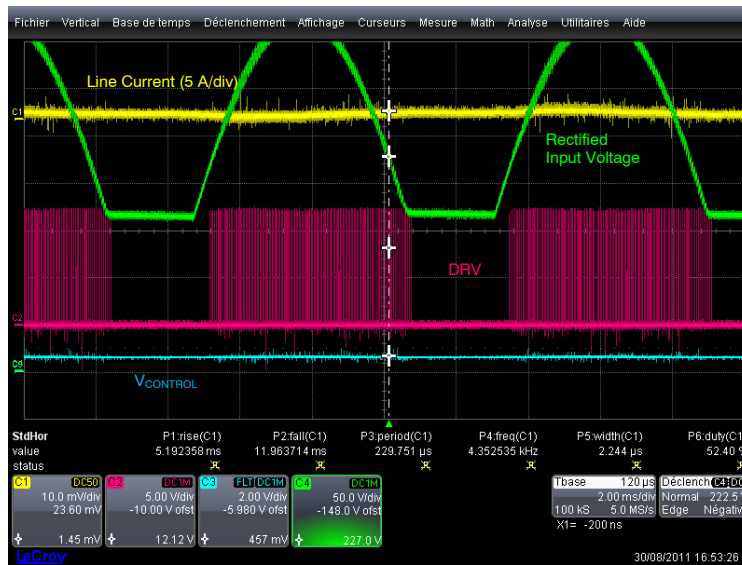

Figure 9. The Circuit Skips Cycle Near the Line Zero Crossing (265 V, 25% Load)

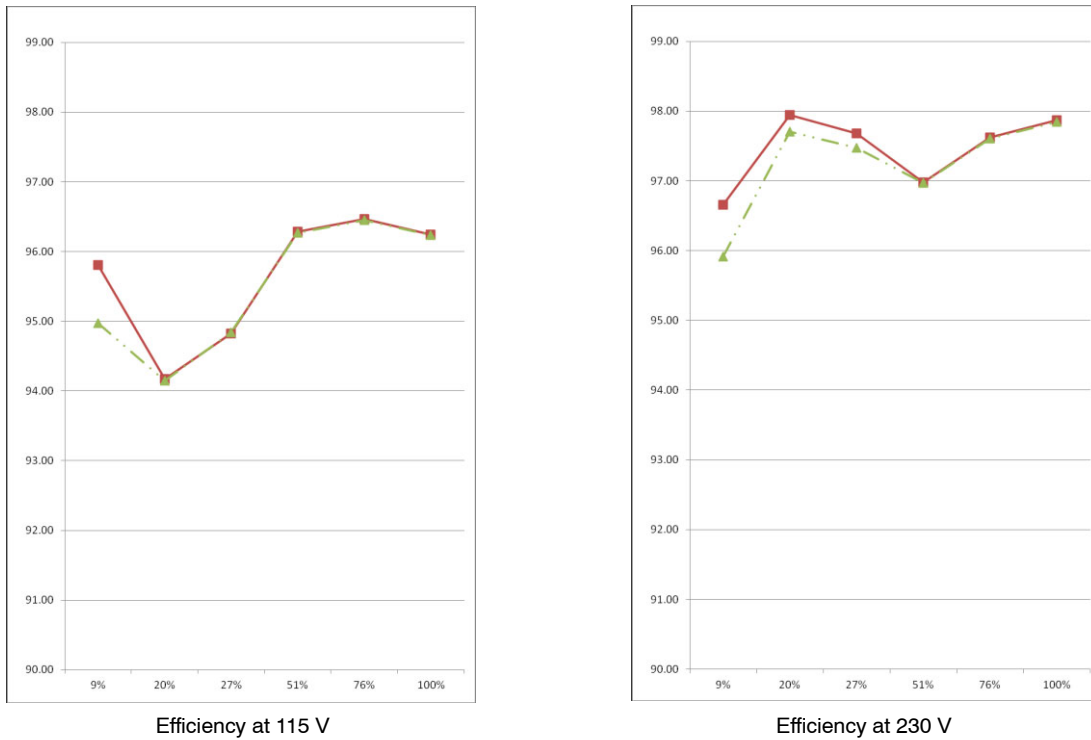

Figure 10. Efficiency versus Load of the Evaluation Board (red solid line) and of the Evaluation Board where Skip Mode is Disabled (green dotted line). In both Cases, the NTC is Shorted.

NCP1611GEVB

POWER FACTOR (PF) AND TOTAL HARMONIC DISTORTION (THD)

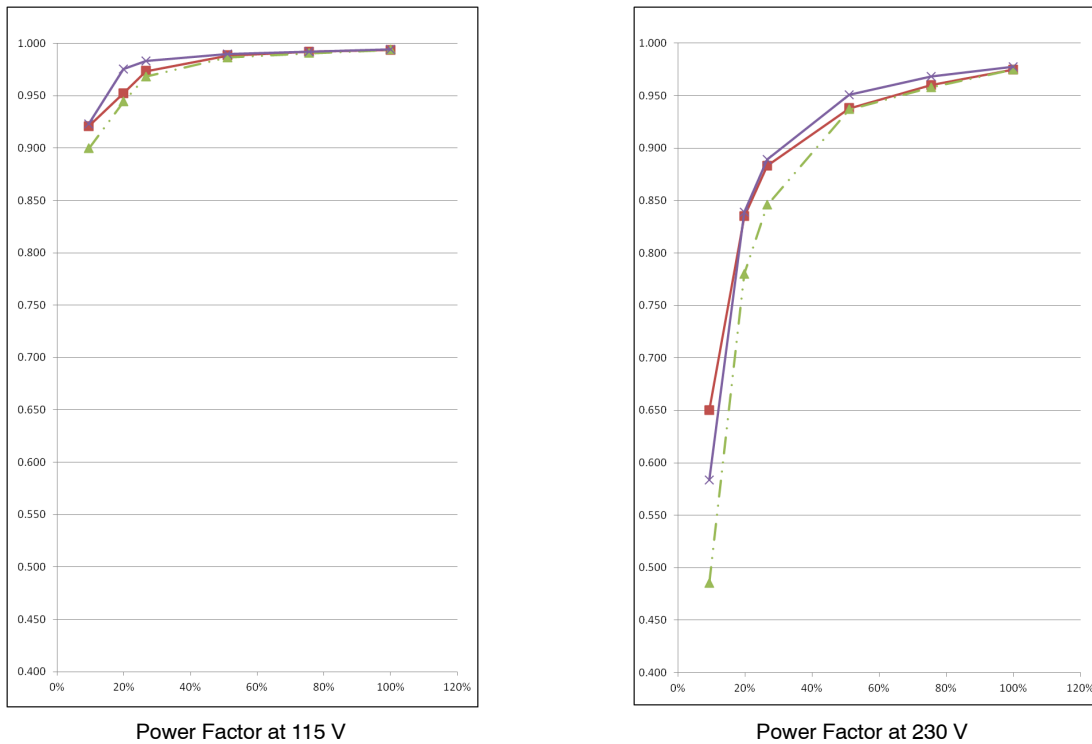

Figure 11. Power Factor versus Load of the Evaluation Board (red solid line), of the Evaluation Board where Skip Mode is Disabled (green dotted line) and of the Evaluation Board Operated in CrM.

PF and THD performance were measured by means of a CHROMA 66202 Digital Power Meter.

Figure 11 and Figure 12 show that CCFF exhibits very similar PF ratios compared those obtained with CrM traditional operation. At high line and very light load, it even improves the PF performance thanks to the skip-mode operation which stops operation near the line zero crossing and hence, in return, forces more current at the top of the line

sine-wave. On the other hand, CCFF slightly degrades the THD performance at light load. This is due to skip-mode operation. As attested by the green curve, when skip mode is disabled, CCFF even exhibits better THD performance than CrM operation. One can easily play with the FFcontrol pin to further improve the PF and THD performance in CCFF operation if needed. Refer to <http://www.onsemi.com/PowerSolutions/product.do?id=NCP1611> for more information.

NCP1611GEVB

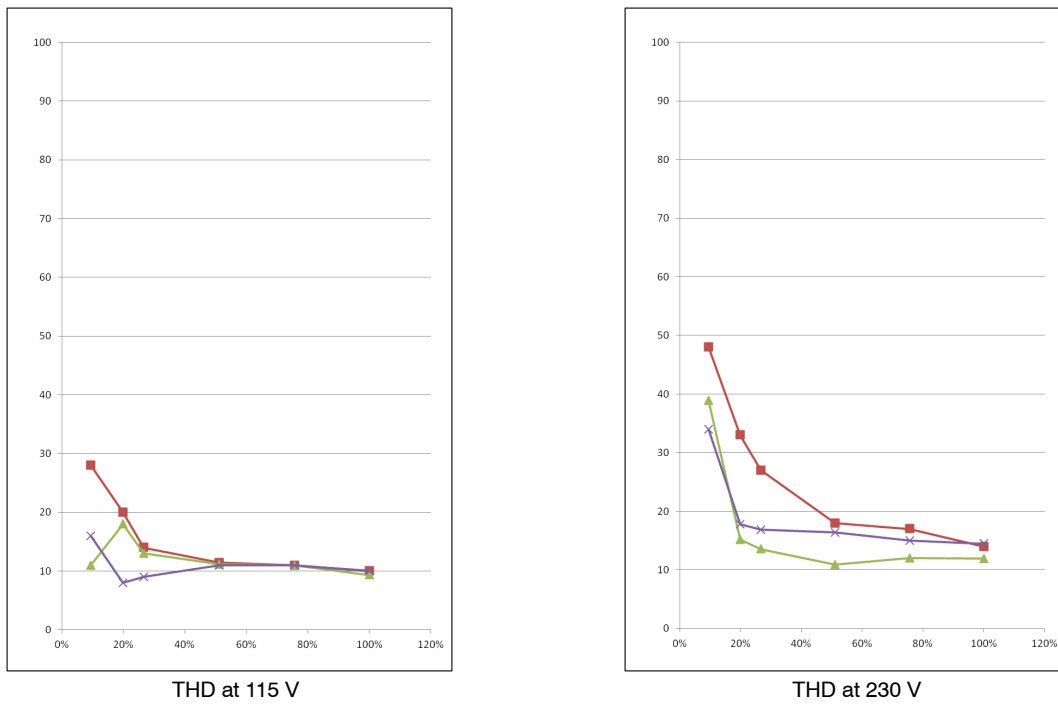

Figure 12. Total Harmonic Distortion (THD) versus Load of the Evaluation Board (red solid line), of the Evaluation Board where Skip Mode is Disabled (green dotted line) and of the Evaluation Board Operated in CrM.

PROTECTION OF THE PFC STAGES

The NCP1611 protection features allow for the design of very rugged PFC stages

Brown-out

An external 15 V V_{CC} power source is applied to the board. The load is 100 mA. The rms input voltage is decreased with 0.1 V steps.

- $(V_{in,rms})_{BOL} = 71.3 \text{ V}$ (rms line voltage below which the circuit stops operating)
- $(V_{in,rms})_{BOH} = 78.6 \text{ V}$ (rms line voltage above which the circuit starts to operate)

a) shows the re-start when the input voltage exceeds the 78.6-V BOH level. The circuit smoothly recovers operation (soft start).

b) shows the NCP1611 behaviour when the line voltage is too low. The line is abruptly changed from 90 V to 70 V at

full load. As a line drop result, the bulk voltage decreases and the circuit responds increasing the control signal ($V_{CONTROL}$). This lasts for the 50 ms blanking time of the brown-out function.

At the end of the 50 ms delay, a brown-out situation is detected. $V_{CONTROL}$ is gradually reduced down to its bottom clamp value (0.5 V) leading the line current to steadily decay as well.

When $V_{CONTROL}$ has reached 0.5 V, the circuit stops pulsing and grounds the $V_{CONTROL}$ pin to ensure a smooth running resumption (soft-start) when the line is brought back to level allowing operation.

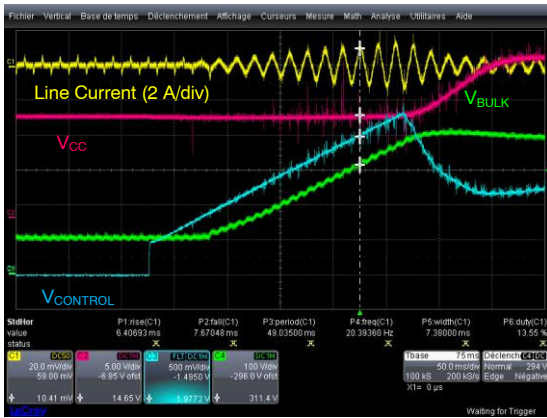

a) Start of operation when $V_{in,rms}$ exceeds $(V_{in,rms})_{BOH}$

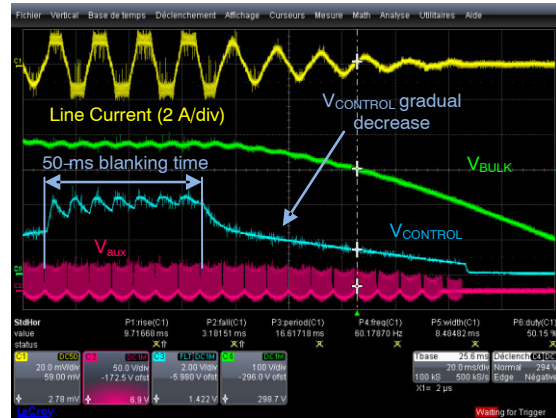

b) Abrupt line drop (90 V to 70 V)

Figure 13. Total Harmonic Distortion (THD) versus Load of the Evaluation Board (red solid line), of the Evaluation Board where Skip Mode is Disabled (green dotted line) and of the Evaluation Board Operated in CrM.

Over-Current Protection (OCP)

The NCP1611 is designed to monitor the current flowing through the power switch. A current sense resistor (R_3 of Figure 2) is inserted between the MOSFET source and ground to generate a positive voltage proportional to the MOSFET current (V_{CS}). When V_{CS} exceeds a 500 mV internal reference, the circuit forces the driver low. A 200 ns blanking time prevents the OCP comparator from tripping because of the switching spikes that occur when the MOSFET turns on.

In our application, the theoretical maximal line current is

$$\left(\frac{1}{2} \cdot \frac{500 \text{ mV}}{80 \text{ m}\Omega} \right) \text{ that is about } 3.1 \text{ A.}$$

Figure 14 shows the line current when clamped. The over-current situation was obtained @ 85 V with a 500 mA load. A 15 V V_{CC} power source was applied to the board.

NCP1611GEVB



Figure 14. Over-Current Situation (85 V, 0.5 A Load Current)

DYNAMIC PERFORMANCE

The NCP1611 features the **dynamic response enhancer** (DRE) that increases the loop gain by an order of magnitude when the output voltage goes below 95.5% of its nominal level. This function dramatically reduces undershoots in case of an abrupt increase of the load demand.

As an example, Figure 15a illustrates a load step from 100 to 400 mA (2-A/ μ s slope) @ 115 V. One can note that as a result of the DRE function, the control signal ($V_{CONTROL}$) steeply rises when the bulk voltage goes below 370 V, leading to a sudden increase of the line current (in our case, this is so sharp that the over-current protection trips to limit

the line current to about 3 A). This sharp reaction dramatically limits the bulk voltage decay. V_{BULK} stays above 365 V and recovers within about 15 ms.

One can further note that the $V_{CONTROL}$ rapidly decrease back to its new steady state level. This is allowed by the use of a type-2 compensation: DRE leads to the charge of the C_{10} capacitor to the high $V_{CONTROL}$ level but C_9 is partly charged only. Our compensation reduces to nearly zero the overshoot that can follow a fast response to an under-voltage.

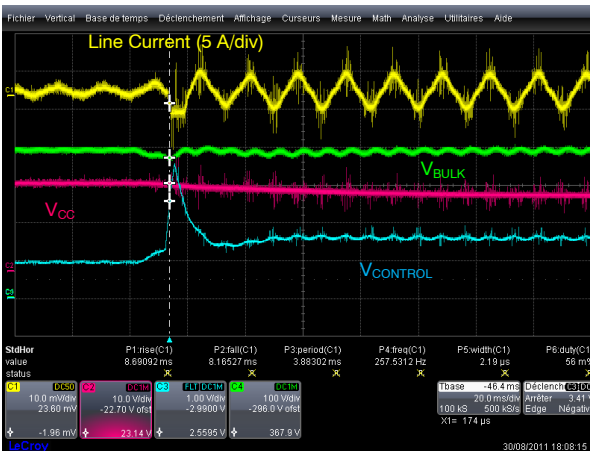

a) Load abrupt rise

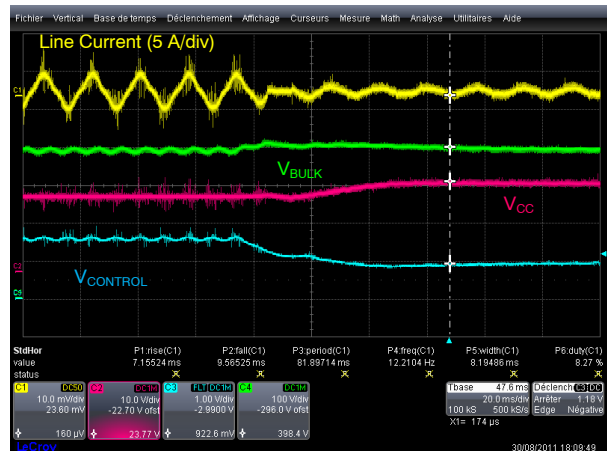

b) Load abrupt decay

Figure 15. Bulk voltage variations when the load changes from 100 to 400 mA (2 A/ μ s slope)

NCP1611GEVB

Figure 15b shows the other transition from (400 mA to 100 mA). Again the bulk voltage deviation is very small: V_{BULK} remains below 410 V. This is because the soft Over Voltage Protection (softOVP) triggers when V_{BULK} exceeds 105% of its nominal voltage and prevents the DRV from pulsing until V_{BULK} has dropped down to a safe level (103% of its nominal voltage).

Figure 16 shows a magnified view of Figure 15b. It illustrates the gradual interruption of the drive pulses flow

for a reduced acoustic noise. The circuit reduces the power delivery by smoothly decaying the on-time to zero within about 50 μ s that is 2 to 10 switching periods according to the conditions of a typical application. If the output voltage rise is so fast that V_{BULK} still significantly increases during this braking phase, a second comparator immediately disables the driver if the output voltage exceeds 107% of its desired level (fast OVP).

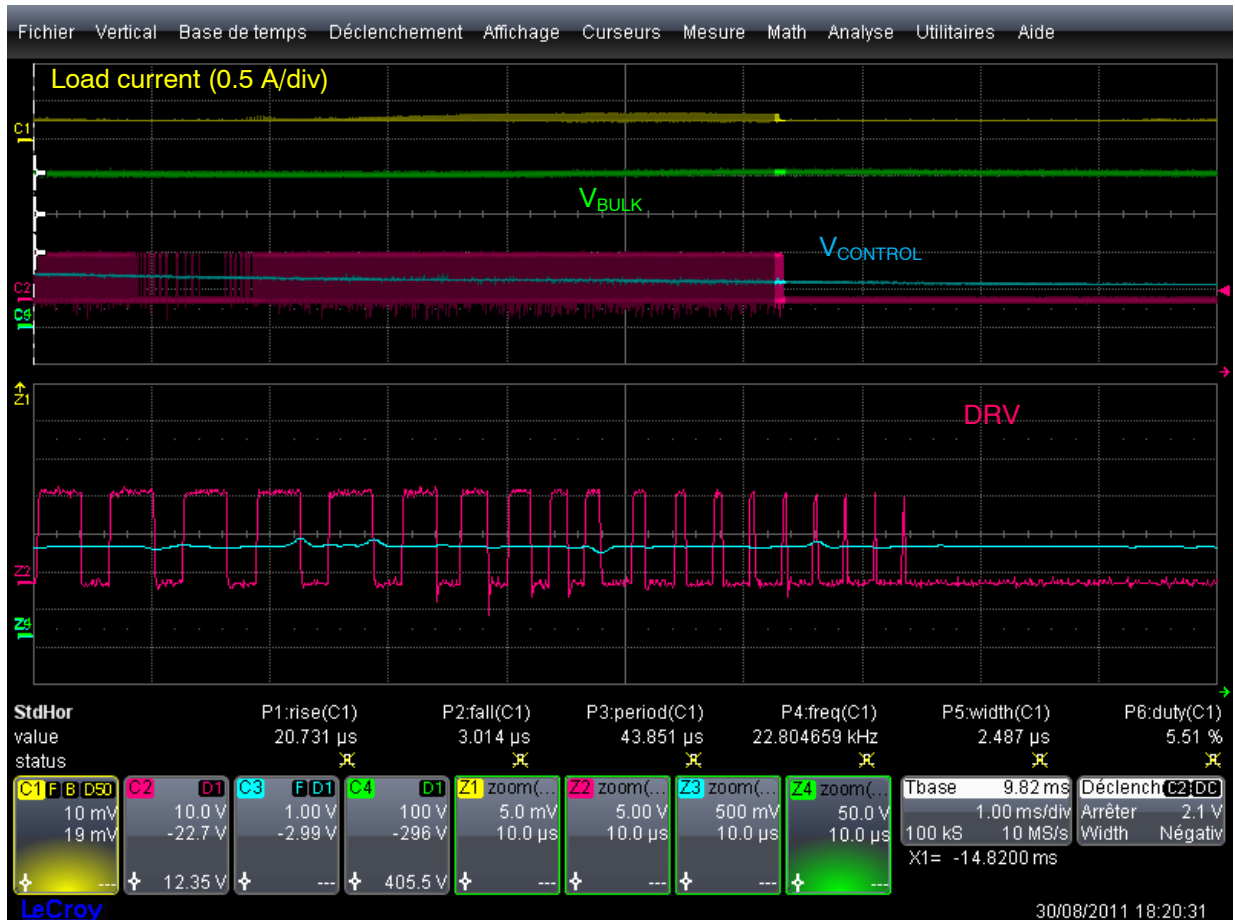

Figure 16. Soft Over-Voltage Protection

BEHAVIOR UNDER FAILURE SITUATIONS

Elements of the PFC stage can be accidentally shorted, badly soldered or damaged as a result of manufacturing incidents, of an excessive operating stress or of other troubles. In particular, adjacent pins of controllers can be shorted, a pin, grounded or badly connected. It is often required that such open/short situations do not cause fire, smoke nor loud noise. The NCP1611 integrates functions that help meet this requirement, for instance, in case of an improper pin connection (including GND) or of a short of the boost or bypass diode. Application note AND9064 details the behavior of a NCP1611-driven PFC stage under safety tests [2].

As an example, we will illustrate here the circuit operation when the PFC bypass diode is shorted. When the PFC stage is plugged in, a large in-rush current takes place that charges the bulk capacitor to the line peak voltage. Traditionally, a bypass diode (D_2 in the application schematic of Figure 2) is placed between the input and output high-voltage rails to divert this inrush current from the inductor and boost diode. When it is shorted, the bulk voltage being equal to the input voltage, the inductor slightly demagnetizes by the only virtue of the conduction losses caused by the inductor losses mainly within the boost diode. This is generally far insufficient to prevent a cycle-by-cycle cumulative rise of

NCP1611GEVB

the inductor current and an unsafe heating of the inductor, the MOSFET and the boost diode.



a) General view

b) Magnified view

Figure 17. Shorting the Bypass Diode and the NTC

The NCP1611 incorporates a second over-current comparator that trips whenever the MOSFET current happens to exceed 150% of its maximum level. Such an event can happen when the current slope is so sharp that the main over-current comparator cannot prevent the current from exceeding this second level as the result of the inductor saturation for instance. In this case, the circuit detects an “Overstress” situation and disables the driver for an 800 μs delay. This long delay leads to a very low duty-ratio operation to dramatically limit the risk of overheating.

Figure 17 illustrates the operation while the bypass diode and the NTC are both shorted @ 115 V with a 0.1 A load current, the NCP1611 being supplied by a 15 V external power source. Two drive pulses occur every 800 μs. The first pulse is limited by the over-current protection. Since the input and output voltages are equal, the inductor has not demagnetized when the next pulse is generated and the

MOSFET turns on while the boost diode is still conducting a large current (see Figure 17b)). Hence, the MOSFET closing causes the second over-current comparator to trip and an “Overstress” situation is detected. As the consequence, no DRV pulse can take until an 800 μs delay has elapsed. The very low duty-ratio prevents the application from heating up.

Please note that we do not guarantee that the a NCP1611-driven PFC stage necessarily passes all the safety tests and in particular the boost diode short one since the performance can vary with respect to the application or conditions. The reported tests are intended to illustrate the typical behavior of the part in one particular application, highlighting the protections helping pass the safety tests. The reported tests were made at 25°C ambient temperature.

NCP1611GEVB

BILL OF MATERIALS

Reference	Qty	Description	Value	Tolerance / Constraints	Footprint	Manufacturer	Part number
HS ₁	1	Heatsink				COLUMBIA-STAVER	TP207ST,120,12.5,N A,SP,03
F ₁	1	4-A fuse	4 A	250 V	through-hole	Multicomp	MCPEP 4A 250V
C ₁ , C ₂	2	Y capacitors	1 nF	275 V	through-hole	EPCOS	B32021A3102
C ₃	1	X2 capacitor	680 nF	277 V	through-hole	EPCOS	B32922C3684K
C ₄	1	X2 capacitor	220 nF	277 V	through-hole	EPCOS	B32922C3224K
C ₅	1	Filtering capacitor	470 nF	450 V	through-hole	EPCOS	B32592C6474K
C _{6a} , C _{6b}	2	Bulk capacitor	68 μ F	450 V	through-hole	Rubycon	450QXW68M12.5X40
C ₇	1	Electrolytic capacitor	22 μ F	50 V	through-hole	various	various
U ₁		Diodes Bridge	GBU406	4 A, 600 V	through-hole	LITE-ON	GBU406
L ₁	1	DM Choke	117 μ H	75 m Ω	through-hole	Pulse Engineering	PH9081NL
CM ₁	1	Common Mode Filter	8.5 mH	85 m Ω	through-hole	Pulse Engineering	PH9080NL
L ₂	1	Boost inductor	200 μ H	6 Apk	through-hole	Würth Elektronik	750370081 (EFD30)
Q ₁	1	Power MOSFET	IPA50R250	550 V	TO220	Infineon	IPA50R250CP
D ₁	1	Boost diode	MUR550	5 A, 520 V	Axial	ON Semiconductor	MUR550APFG
D ₂	1	Bypass diode	1N5406	3 A, 600 V	Axial	ON Semiconductor	1N5406G
DZ ₂	1	33-V ZENER diode	MMSZ33T2	33 V, 0.5 W	SOD-123	ON Semiconductor	MMSZ33T2
Rth ₁	1	Inrush Current Limiter	15 Ω	1.8 Amax	through-hole	EPCOS	B57153S0150M000
D ₃ , D ₄	2	Switching diode	D1N4148	100 V	SOD123	Vishay	1N4148W-V
R ₁ , R ₂	2	X2 Capacitors discharge resistor	1 M Ω	1%, 500V	SMD, 1206	various	various
R ₃	1	Current sense resistor	80 m Ω	1%, 3W	through-hole	Vishay	LVR03R0800FE12
R ₄	1	resistor	10 k Ω	10%, 1/4W	SMD, 1206	various	various
R ₅	1	resistor	2.2 Ω	10%, 1/4W	SMD, 1206	various	various
R ₆	1	resistor	22 Ω	10%, 1/4W	SMD, 1206	various	various
R ₇ , R ₁₃	2	resistor	0 Ω	1%, 1/4W	SMD, 1206	various	various
R ₉ , R ₁₀ , R ₂₃ , R ₂₄ , R ₂₅	5	resistor	1.8 M Ω	1%, 1/4W	SMD, 1206	various	various
R ₈ , R ₂₂	2	SMD resistor, 1206, 1/4W	560 k Ω	1%, 1/4W	SMD, 1206	various	various

NCP1611GEVB

Reference	Qty	Description	Value	Tolerance / Constraints	Footprint	Manufacturer	Part number
R11	1	resistor	27 kΩ	1%, 1/4W	SMD, 1206	various	various
R12	1	resistor	22 kΩ	1%, 1/4W	SMD, 1206	various	various
R14	1	resistor	270 kΩ	1%, 1/4W	SMD, 1206	various	various
R15, R16, R17	3	resistor	120 kΩ	10%, 1/4W	SMD, 1206	various	various
R18	1	resistor	27 Ω	10%, 1/4W	SMD, 1206	various	various
R20, R21	2	resistor	4.7 kΩ	5%, 1/4W	SMD, 1206	various	various
R26	1	resistor	120 kΩ	1%, 1/4W	SMD, 1206	various	various
C8	1	Capacitor	1 nF	25 V, 10%	SMD, 1206	various	various
C9	1	Capacitor	2.2 μF	25 V, 10%	SMD, 1206	various	various
C10, C15	2	Capacitor	220 nF	25 V, 10%	SMD, 1206	various	various
C11, C16	2	Capacitor	470 pF	25 V, 10%	SMD, 1206	various	various
C13	1	Capacitor	10 nF	100 V, 10%	SMD, 1206	various	various
D5, D6	2	Switching diode	D1N4148	100 V	SOD123	Vishay	1N4148W-V
DZ1	1	22-V zener diode	MMSZ22T1	22 V, 0.5 W	SOD-123	ON Semiconductor	MMSZ22T1
U2	1	PFC Controller	NCP1611		SOIC-8	ON Semiconductor	NCP1611B

NOTE: Applications require the use of Y1 capacitors. In this case, CD12-E2GA102MYNSA from TDK or DE1E3KX102MA5B01 from muRata may be a good option for C1 and C2.

REFERENCES

- [1] Joel Turchi, “5 key steps to design a compact, high-efficiency PFC Stage Using The NCP1611”, Application note AND9062/D, http://www.onsemi.com/pub_link/Collateral/AND9062-D.PDF.
- [2] Joel Turchi, “Safety tests on a NCP1611-driven PFC stage”, Application note AND9064/D, http://www.onsemi.com/pub_link/Collateral/AND9064-D.PDF.
- [3] NCP1611 Data Sheet, http://www.onsemi.com/pub_link/Collateral/NCP1611-D.PDF
- [4] NCP1611 design worksheet, <http://www.onsemi.com/PowerSolutions/supportDoc.do?type=tools&rpn=NCP1611>
- [5] NCP1611 evaluation board documents, <http://www.onsemi.com/PowerSolutions/supportDoc.do?type=boards&rpn=NCP1611>

ON Semiconductor and the ON Semiconductor logo are trademarks of Semiconductor Components Industries, LLC dba ON Semiconductor or its subsidiaries in the United States and/or other countries. ON Semiconductor owns the rights to a number of patents, trademarks, copyrights, trade secrets, and other intellectual property. A listing of ON Semiconductor's product/patent coverage may be accessed at www.onsemi.com/site/pdf/Patent-Marking.pdf. ON Semiconductor is an Equal Opportunity/Affirmative Action Employer. This literature is subject to all applicable copyright laws and is not for resale in any manner.

The evaluation board/kit (research and development board/kit) (hereinafter the "board") is not a finished product and is as such not available for sale to consumers. The board is only intended for research, development, demonstration and evaluation purposes and should as such only be used in laboratory/development areas by persons with an engineering/technical training and familiar with the risks associated with handling electrical/mechanical components, systems and subsystems. This person assumes full responsibility/liability for proper and safe handling. Any other use, resale or redistribution for any other purpose is strictly prohibited.

The board is delivered "AS IS" and without warranty of any kind including, but not limited to, that the board is production-worthy, that the functions contained in the board will meet your requirements, or that the operation of the board will be uninterrupted or error free. ON Semiconductor expressly disclaims all warranties, express, implied or otherwise, including without limitation, warranties of fitness for a particular purpose and non-infringement of intellectual property rights.

ON Semiconductor reserves the right to make changes without further notice to any board.

You are responsible for determining whether the board will be suitable for your intended use or application or will achieve your intended results. Prior to using or distributing any systems that have been evaluated, designed or tested using the board, you agree to test and validate your design to confirm the functionality for your application. Any technical, applications or design information or advice, quality characterization, reliability data or other services provided by ON Semiconductor shall not constitute any representation or warranty by ON Semiconductor, and no additional obligations or liabilities shall arise from ON Semiconductor having provided such information or services.

The boards are not designed, intended, or authorized for use in life support systems, or any FDA Class 3 medical devices or medical devices with a similar or equivalent classification in a foreign jurisdiction, or any devices intended for implantation in the human body. Should you purchase or use the board for any such unintended or unauthorized application, you shall indemnify and hold ON Semiconductor and its officers, employees, subsidiaries, affiliates, and distributors harmless against all claims, costs, damages, and expenses, and reasonable attorney fees arising out of, directly or indirectly, any claim of personal injury or death associated with such unintended or unauthorized use, even if such claim alleges that ON Semiconductor was negligent regarding the design or manufacture of the board.

This evaluation board/kit does not fall within the scope of the European Union directives regarding electromagnetic compatibility, restricted substances (RoHS), recycling (WEEE), FCC, CE or UL, and may not meet the technical requirements of these or other related directives.

FCC WARNING – This evaluation board/kit is intended for use for engineering development, demonstration, or evaluation purposes only and is not considered by ON Semiconductor to be a finished end product fit for general consumer use. It may generate, use, or radiate radio frequency energy and has not been tested for compliance with the limits of computing devices pursuant to part 15 of FCC rules, which are designed to provide reasonable protection against radio frequency interference. Operation of this equipment may cause interference with radio communications, in which case the user shall be responsible, at its expense, to take whatever measures may be required to correct this interference.

ON Semiconductor does not convey any license under its patent rights nor the rights of others.

LIMITATIONS OF LIABILITY: ON Semiconductor shall not be liable for any special, consequential, incidental, indirect or punitive damages, including, but not limited to the costs of requalification, delay, loss of profits or goodwill, arising out of or in connection with the board, even if ON Semiconductor is advised of the possibility of such damages. In no event shall ON Semiconductor's aggregate liability from any obligation arising out of or in connection with the board, under any theory of liability, exceed the purchase price paid for the board, if any.

For more information and documentation, please visit www.onsemi.com.

PUBLICATION ORDERING INFORMATION

LITERATURE FULFILLMENT:

Email Requests to: orderlit@onsemi.com

ON Semiconductor Website: www.onsemi.com

TECHNICAL SUPPORT

North American Technical Support:

Voice Mail: 1 800-282-9855 Toll Free USA/Canada

Phone: 011 421 33 790 2910

Europe, Middle East and Africa Technical Support:

Phone: 00421 33 790 2910

For additional information, please contact your local Sales Representative