

Lednium Series Optimal I

Flush Mount and Surface Mount Packages

OVTL01LGAx Series

- Robust energy-efficient design with long operating life
- Low thermal resistance (2° C/W)
- Exceptional spatial uniformity
- Available in amber, blue, cyan, green, red, cool white, daylight white, and warm white

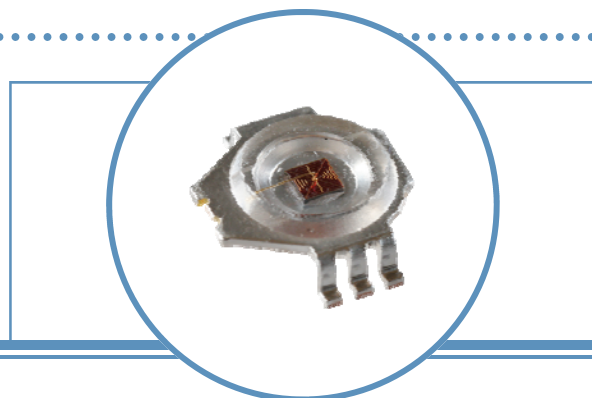

The **OVTL01LGAx Series** offers an energy-efficient packaged LED source providing high luminance, low thermal resistance, a water-clear lens, and a long operating lifespan. Devices have a 135° typical viewing angle with optional optics available and two mounting options:

1. Flush Mount—The shallow-gullwing package is designed to be countersunk into a hole or cavity in the PC board for a low profile of only 1.12mm.
2. Surface Mount—The deep-gullwing package is easily mounted on the solid surface of the PC board (Part numbers end in “S”)

Applications

- Automotive exterior and interior lighting
- Architectural lighting
- Electronic signs and signals

Part Number	Viewing Angle	Emitted Color	Typical Luminous Flux (lm)	Package
OVTL01LGAA	135°	Amber	35	Flush Mount
OVTL01LGAB		Blue	12	Flush Mount
OVTL01LGAC		Cyan	40	Flush Mount
OVTL01LGAG		Green	60	Flush Mount
OVTL01LGAR		Red	45	Flush Mount
OVTL01LGAW		Cool White	65	Flush Mount
OVTL01LGAWD		Daylight White	60	Flush Mount
OVTL01LGAWW		Warm White	50	Flush Mount
OVTL01LGAAS		Amber	35	Surface Mount
OVTL01LGABS		Blue	12	Surface Mount
OVTL01LGACS		Cyan	40	Surface Mount
OVTL01LGAGS		Green	60	Surface Mount
OVTL01LGARS		Red	45	Surface Mount
OVTL01LGAWS		Cool White	65	Surface Mount
OVTL01LGAWDS		Daylight White	60	Surface Mount
OVTL01LGAWWS		Warm White	50	Surface Mount

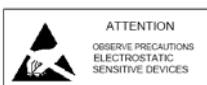

DO NOT LOOK DIRECTLY AT LED WITH UNSHIELDED EYES OR DAMAGE TO RETINA MAY OCCUR.

OPTEK reserves the right to make changes at any time in order to improve design and to supply the best product possible.

Lednium Series Optimal I

OVTL01LGA Series

Package Drawing:

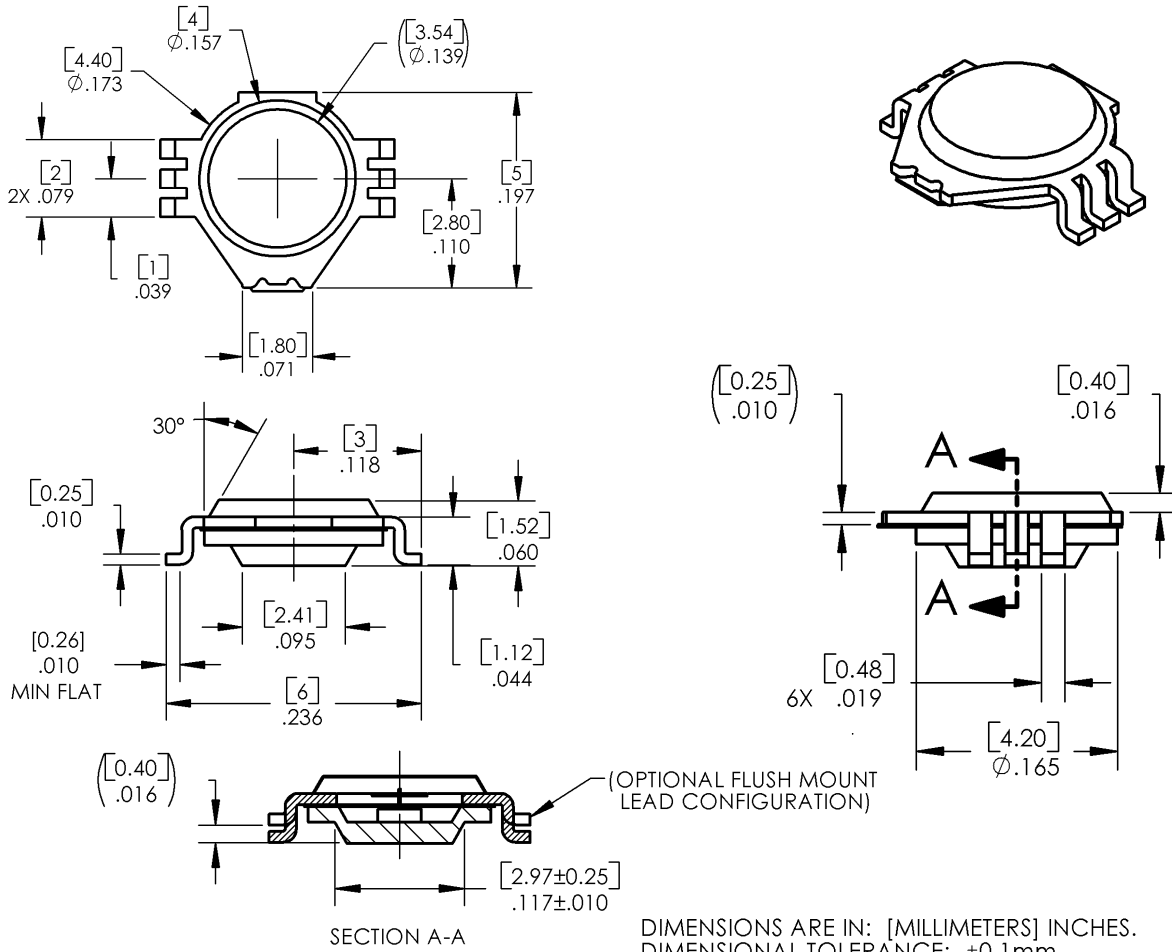

FLUSH MOUNT Recommended Solder Pattern

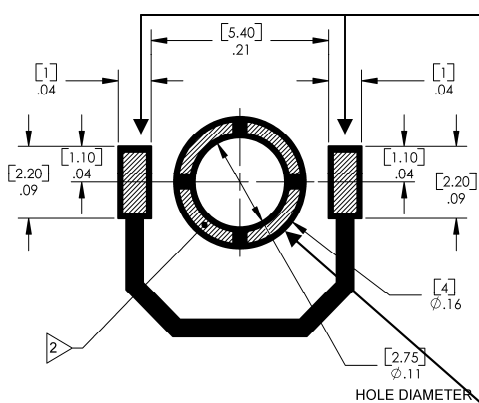

SURFACE MOUNT Recommended Solder Pattern

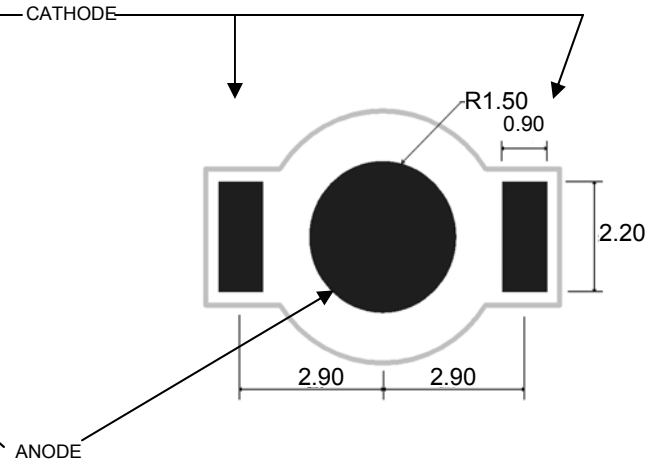

1. Recommend .006 [015] thick stencil.
2. Cross-hatching represents solder paste positioning
3. Dimensions are in inches [mm]

OPTEK reserves the right to make changes at any time in order to improve design and to supply the best product possible.

Lednium Series Optimal I

OVTL01LGA Series



Absolute Maximum Ratings

DC Forward Current	0.35 A
Peak Pulsed Forward Current ¹	1 A
Reverse Voltage	5 V
Maximum Allowable Junction Temperature ²	130° C
Storage and Operating Temperature	-50° ~ +85° C

Notes:

1. Pulse width 1 ms maximum. Duty cycle 1/16.
2. Thermal Resistance junction to Board ($T_{j\theta}$) is 2° C/W, see Application Bulletin 238

Electrical Characteristics ($I_F = 350$ mA, $T_J = 25^\circ$ C)

SYMBOL	PARAMETER	MIN	TYP	MAX	UNITS
V_F	Forward Voltage (Amber)	1.9	2.3	2.6	V
	Forward Voltage (Blue)	2.9	3.4	3.7	V
	Forward Voltage (Cyan & Green)	2.9	3.4	3.7	V
	Forward Voltage (Red)	1.9	2.3	2.6	V
	Forward Voltage (White)	2.9	3.4	3.7	V
	V_{F-T} Temperature Co-efficient (Amber & Red)	----	-6.0	----	mV/°C
	V_{F-T} Temperature Co-efficient (White & Blue)	----	-4.8	----	mV/°C
	V_{F-T} Temperature Co-efficient (Cyan & Green)	----	-5.0	----	mV/°C

Optical Characteristics ($I_F = 350$ mA, $T_J = 25^\circ$ C)

COLOR	DOMINANT WAVELENGTH			SPECTRAL FULL-WIDTH HALF-MAXIMUM	DOMINANT WAVELENGTH TEMPERATURE DEPENDENCE
	MIN	TYP	MAX		
Amber	590	595	600	16 nm	0.08 nm/° C
Blue	455	460	465	24 nm	0.05 nm/° C
Cyan	500	505	510	37nm	0.04 nm/° C
Green	510	515	520	40 nm	0.04 nm/° C
Red	620	625	630	18 nm	0.05 nm/° C

Color	Minimum CCT (°K)	Maximum CCT (°K)	Chromaticity Coordinates				
Cool White	6400	7600	C_x	.298	.304	.316	.313
			C_y	.314	.297	.318	.34
Daylight White	5200	6400	C_x	.313	.317	.336	.338
			C_y	.341	.313	.345	.382
Warm White	3200	3800	C_x	.388	.403	.440	.419
			C_y	.375	.424	.440	.391

OPTEK's Lednium Series Solid State Lighting products package the highest quality LED chips. Typically, the lumen output of these can be as high as 70% after 50,000 hours of operation. This prediction is based on specific test results and on tests on similar materials, and relies on strict observation of the design limits and ratings included in this data sheet.

OPTEK reserves the right to make changes at any time in order to improve design and to supply the best product possible.

Lednium Series Optimal I

OVTL01LGA Series



Standard Bins

Lamps are sorted to luminous flux (Φ) and forward voltage (V_F) bins shown. Orders may be filled with any or all bins contained as below.

OVTL01LGAA and OVTL01LGAAS (AMBER) ($I_F = 350$ mA)

Dominant Wavelength 590-600nm

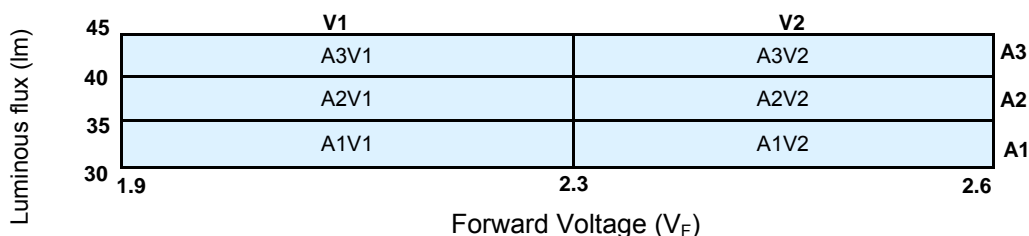

OVTL01LGAB and OVTL01LGABS (BLUE) ($I_F = 350$ mA)

Dominant Wavelength 455-465nm

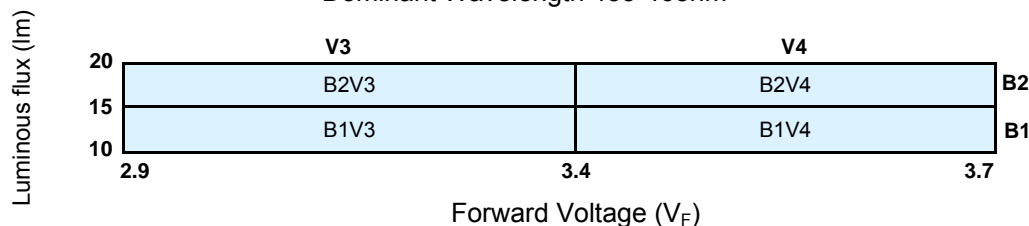

OVTL01LGAC and OVTL01LGACS (CYAN) ($I_F = 350$ mA)

Dominant Wavelength 500-510nm

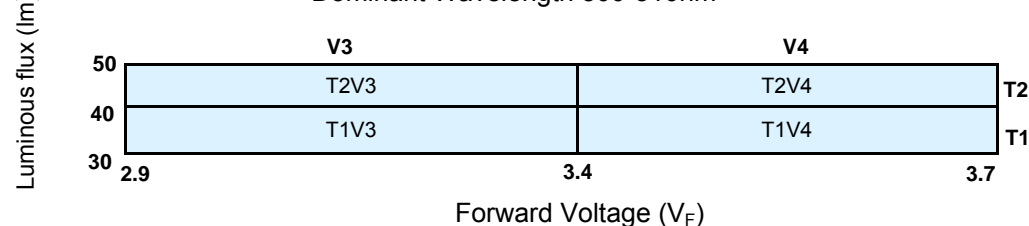

OVTL01LGAG and OVTL01LGAGS (GREEN) ($I_F = 350$ mA)

Dominant Wavelength 510-520nm

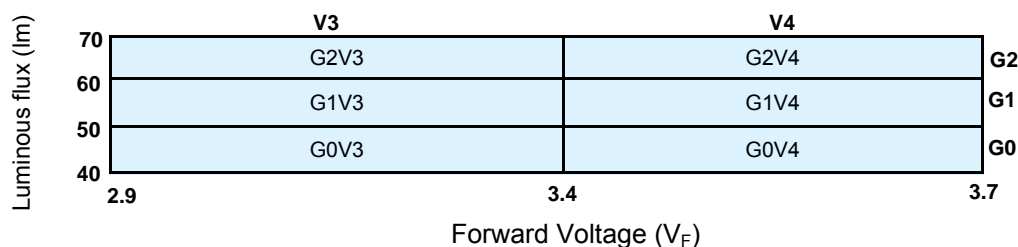

Important Notes:

1. All ranks will be included per delivery, rank ratio will be based on the chip distribution.
2. To designate forward voltage and luminous flux ranks, please contact OPTeK.

OPTeK reserves the right to make changes at any time in order to improve design and to supply the best product possible.

Lednium Series Optimal I

OVTL01LGA Series



Standard Bins

Lamps are sorted to luminous flux (Φ) and forward voltage (V_F) bins shown. Orders may be filled with any or all bins contained as below.

OVTL01LGAR and OVTL01LGARS (RED) ($I_F = 350$ mA)

Dominant Wavelength 620-630nm

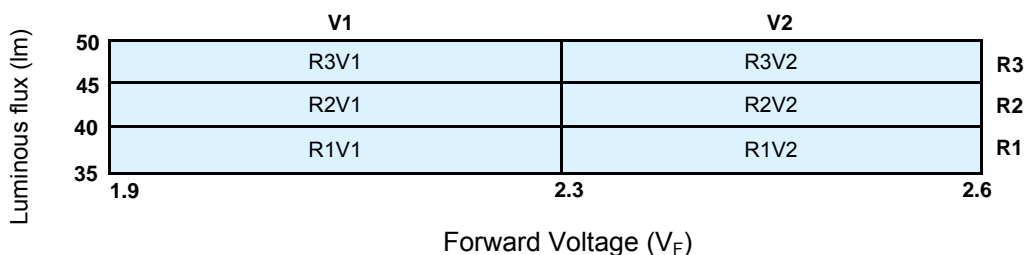

OVTL01LGAW and OVTL01LGAWS (COOL WHITE) ($I_F = 350$ mA)

Typical CCT 7000°K (± 600 °K)

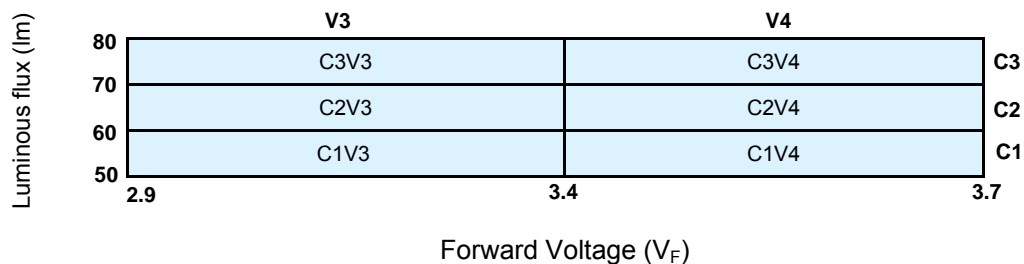

OVTL01LGAWD and OVTL01LGAWDS (DAYLIGHT WHITE) ($I_F = 350$ mA)

Typical CCT 5800°K (± 600 °K)

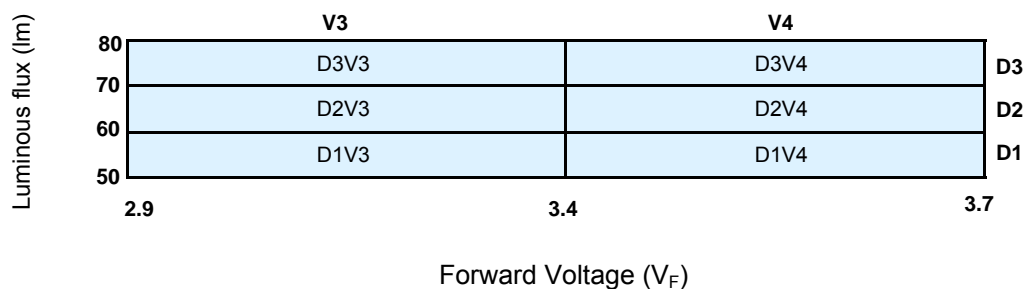

OPTEK reserves the right to make changes at any time in order to improve design and to supply the best product possible.

Lednium Series Optimal I

OVTL01LGA Series



Standard Bins

Lamps are sorted to luminous flux (Φ) and forward voltage (V_F) bins shown. Orders may be filled with any or all bins contained as below.

OVTL01LGAWW and OVTL01LGAWWS (WARM WHITE) ($I_F = 350$ mA)

Typical CCT 3500°K ($\pm 300^\circ$ K)

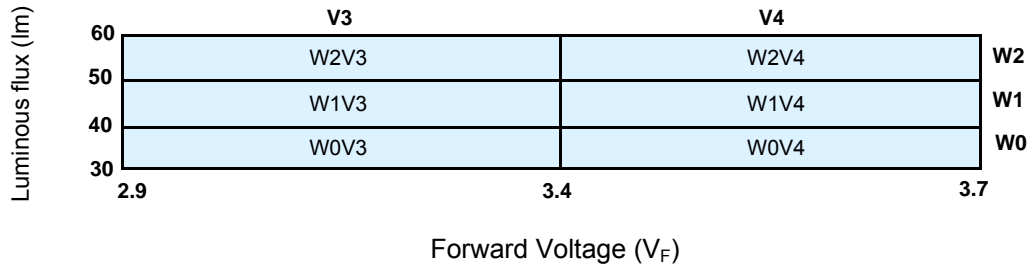

White Color Bins

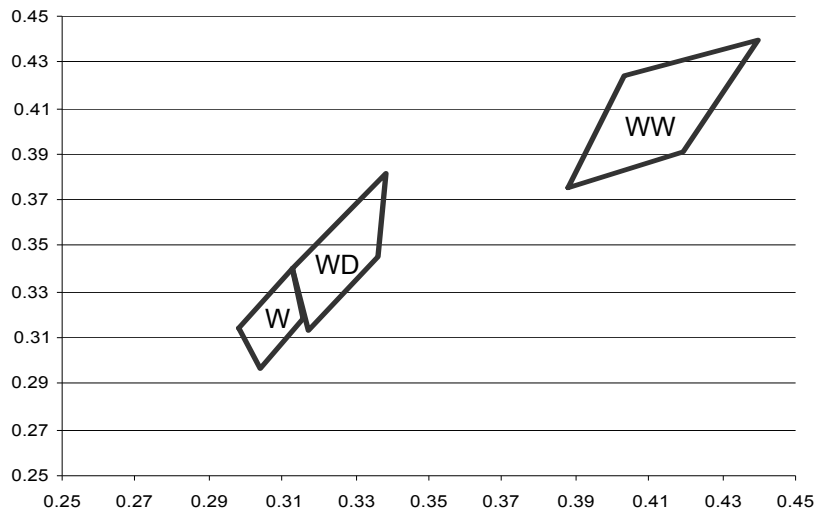

	Color	CCT
W	Cool White	7000°K \pm 600
WD	Daylight White	5800°K \pm 600
WW	Warm White	3500°K \pm 300

OPTEK reserves the right to make changes at any time in order to improve design and to supply the best product possible.

CIE Chromaticity Diagram

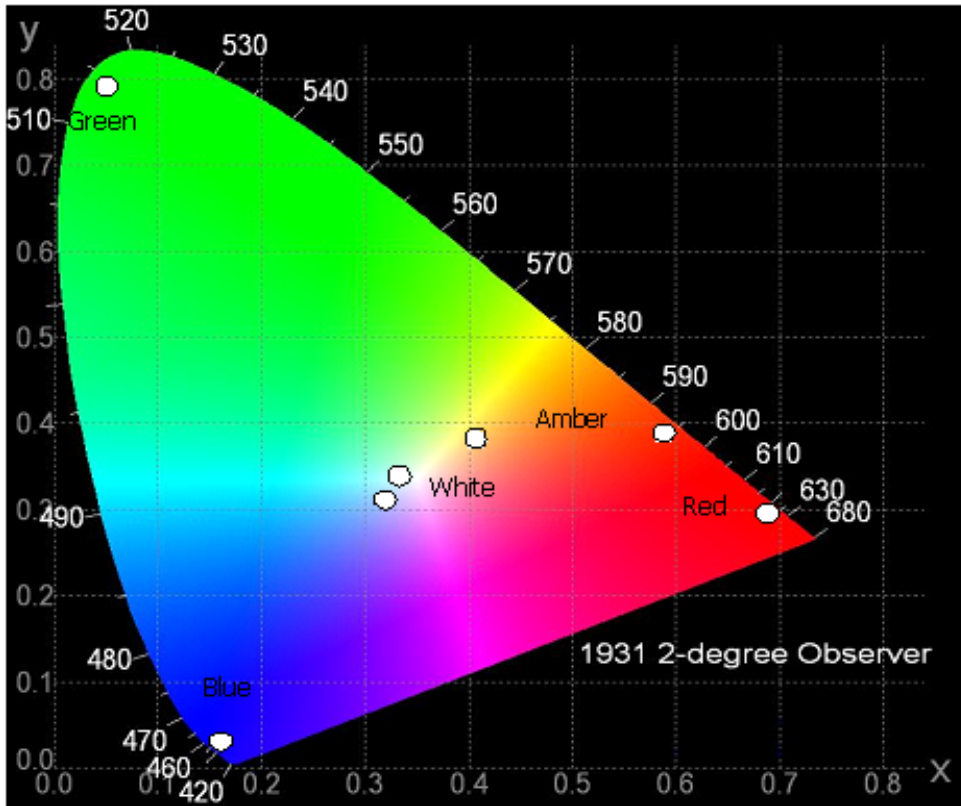

Spatial Intensity Distribution

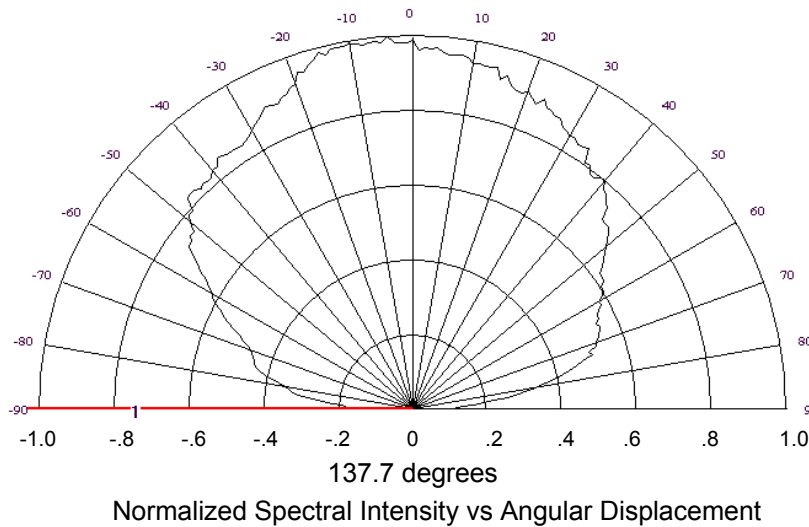

OPTEK reserves the right to make changes at any time in order to improve design and to supply the best product possible.

Typical Electro-Optical Characteristics Curves

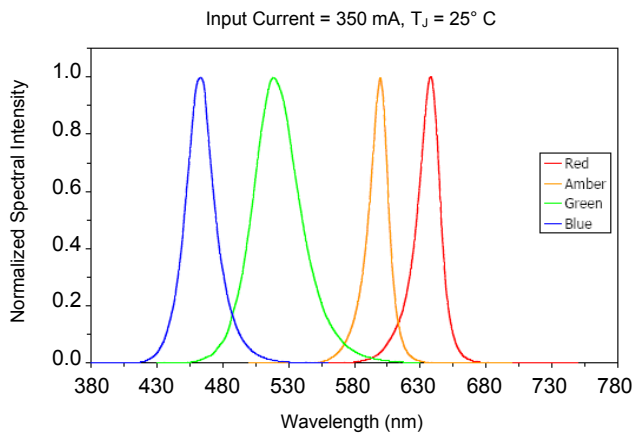

Wavelength Characteristics

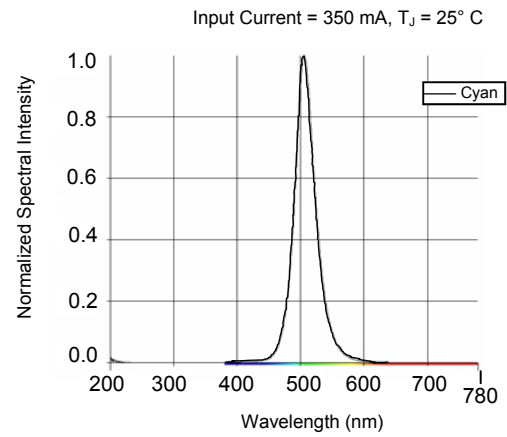

Wavelength Characteristics

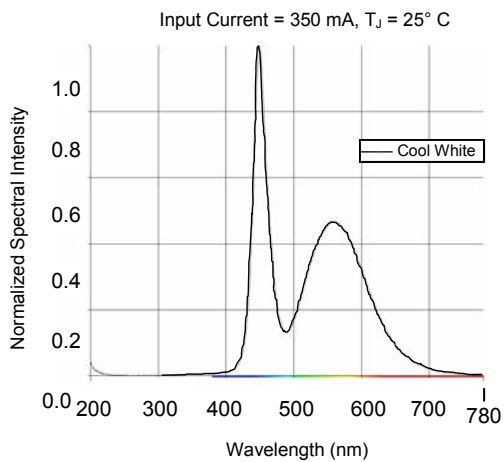

Wavelength Characteristics

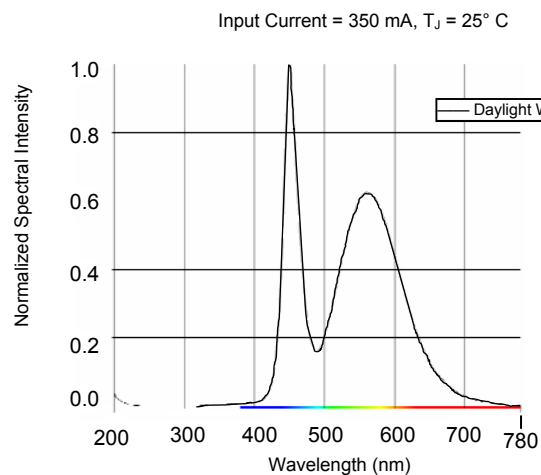

Wavelength Characteristics

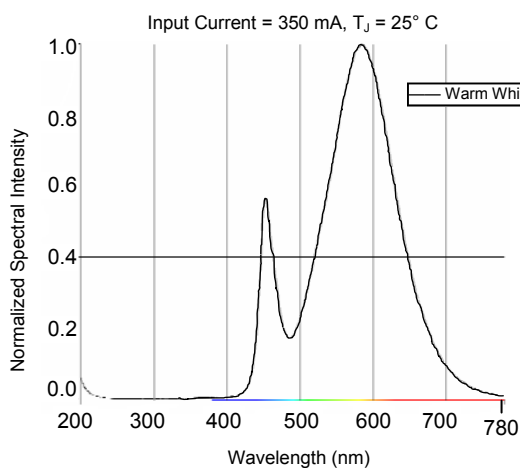

Wavelength Characteristics

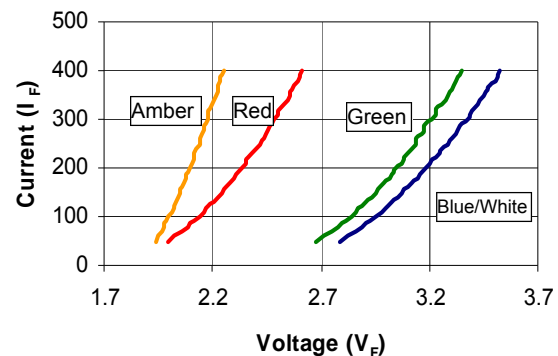

Forward Current vs. Forward Voltage

OPTeK reserves the right to make changes at any time in order to improve design and to supply the best product possible.

Typical Electro-Optical Characteristics Curves

Luminosity normalized to $T_J = 25^\circ\text{C}$

OPTEK Part Number	% Normalized Luminosity at Junction Temperature ($^\circ\text{C}$)					
	0	25	50	75	100	125
OVTLO1LGAA(S)	125	100	85	70	60	45
OVTLO1LGAB(S)	107	100	95	87	75	65
OVTLO1LGAG(S)	110	100	95	85	70	65
OVTLO1LGAR(S)	135	100	90	75	65	50
OVTLO1LGAW(S)	105	100	93	82	68	60
OVTLO1LGAWD(S)	105	100	93	82	68	60
OVTLO1LGAWW(S)	105	100	93	82	68	60

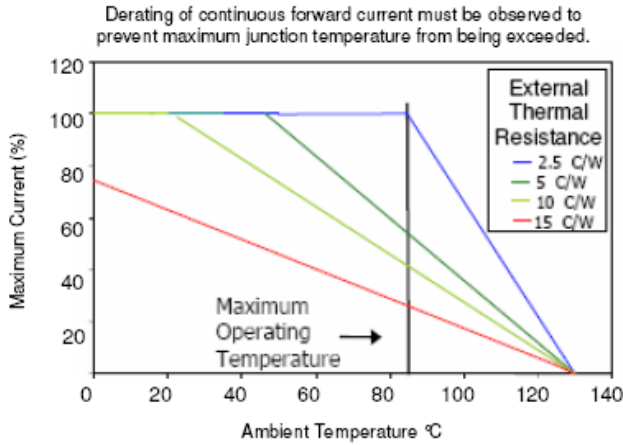
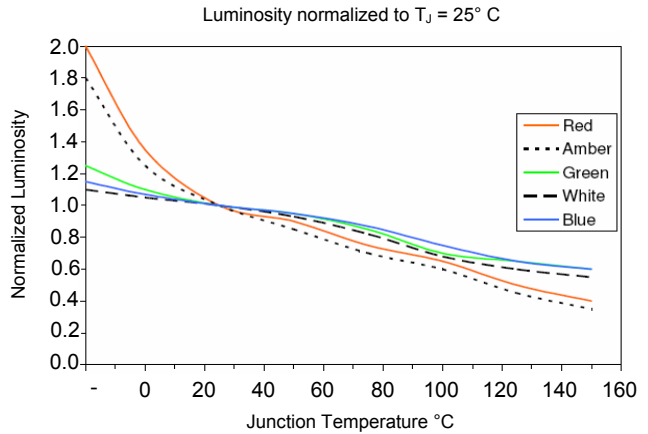

Derating Curves - Blue, Green and White LEDs

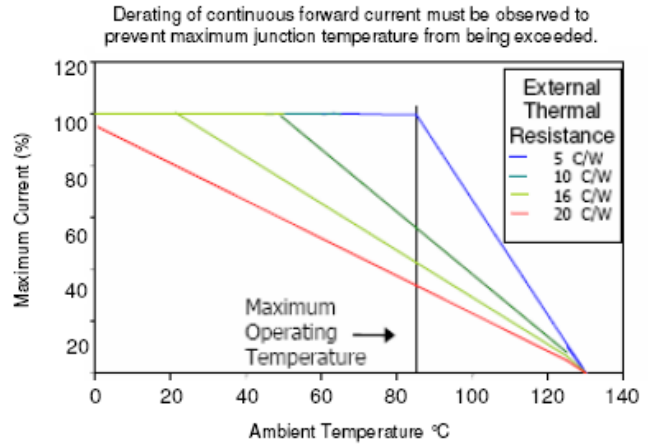

Derating Curves - Amber and Red LEDs

Solder Reflow Cycle

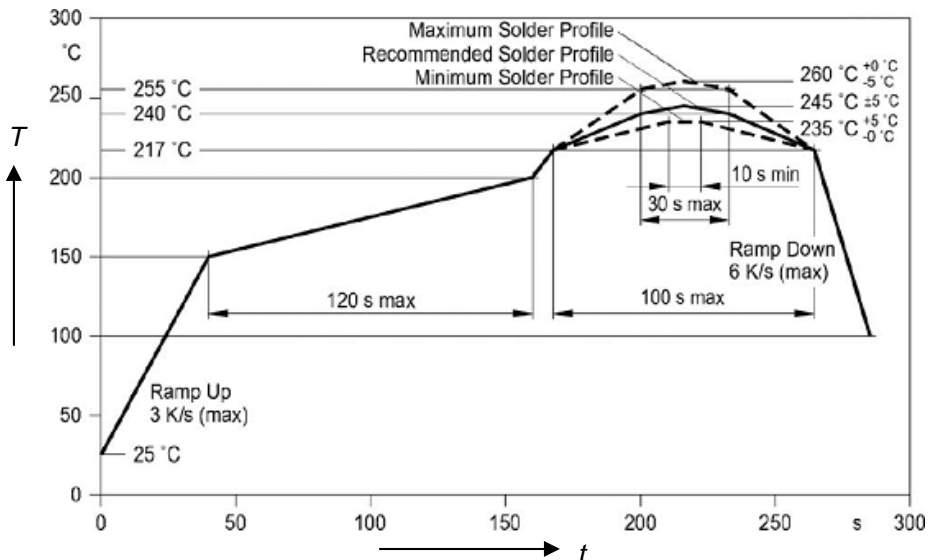

OPTEK reserves the right to make changes at any time in order to improve design and to supply the best product possible.

Lednium Series Optimal I

OVTL01LGA Series



Reel Dimensions:

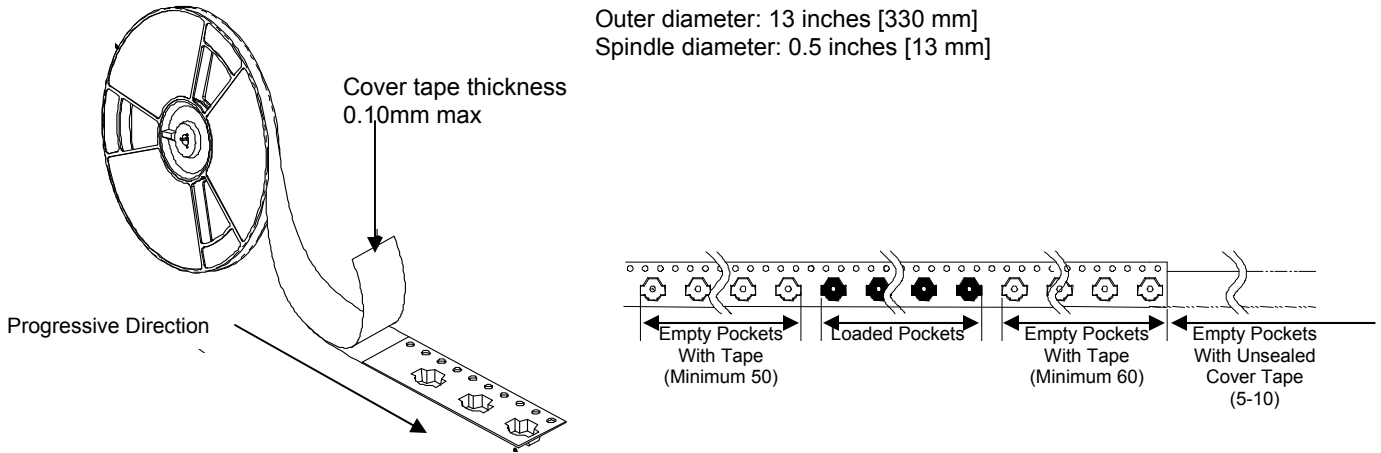

Carrier Tape Dimensions: Loaded quantity 1000 maximum pieces per reel

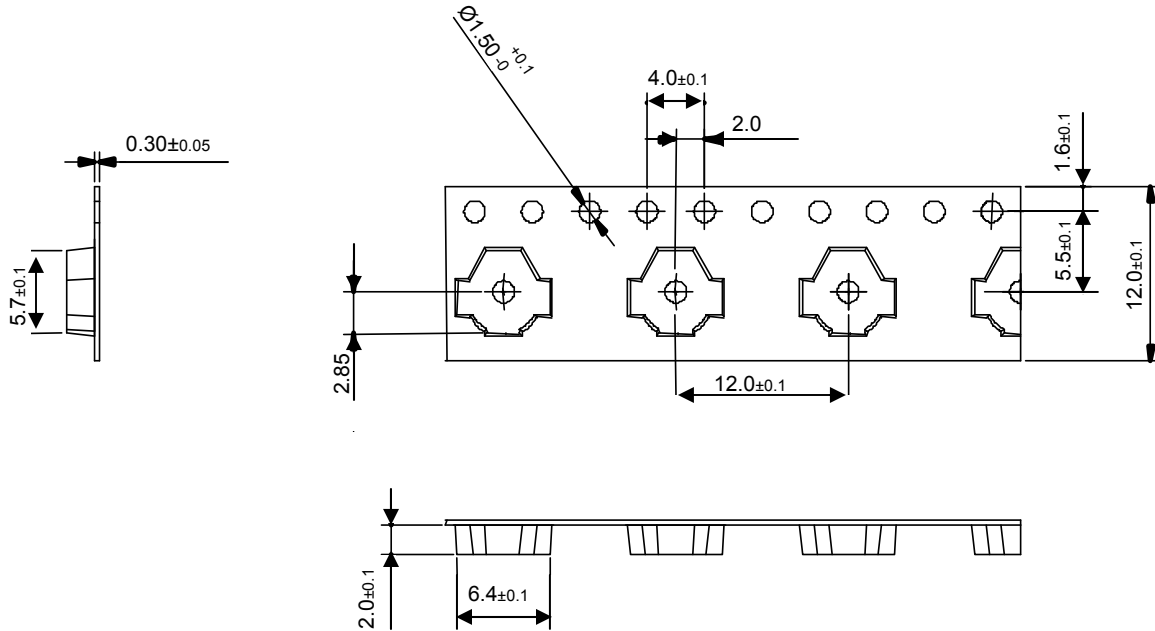

Moisture Resistant Packaging

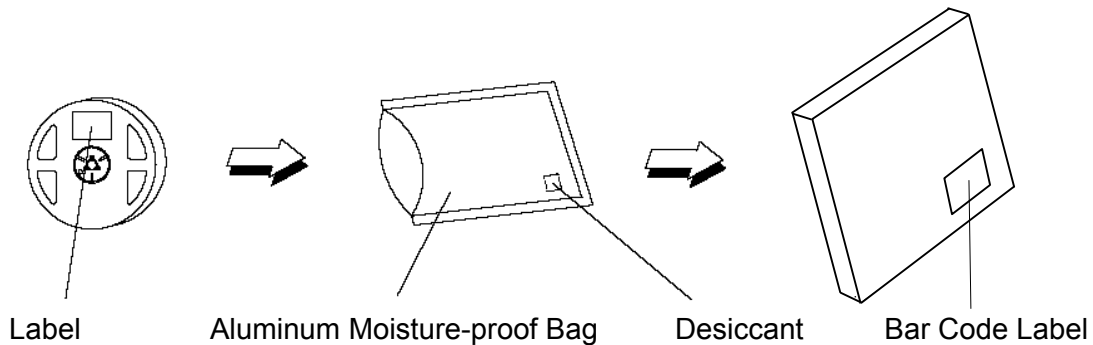

OPTEK reserves the right to make changes at any time in order to improve design and to supply the best product possible.