

---

---

**PIC32CM JH01 Curiosity Pro Evaluation Kit User Guide**

---

---

**Preface**

---

The Microchip® PIC32CM JH01 Curiosity Pro evaluation kit is a hardware platform to evaluate the Microchip PIC32CM JH01 microcontroller (MCU). Each evaluation kit is supported by the MPLAB® X Integrated Development Environment (IDE) and MPLAB® Harmony v3, featuring application examples.

The Curiosity Pro evaluation kits include an on-board embedded debugger (EDBG) to program or debug the target microcontroller. This enables an easy start to a project, and provides application examples that can be used in the design of a custom application.

The Curiosity Pro evaluation kits provide easy access to the features of the microcontroller, and are integrated with Arduino Uno, mikroBUS™, and extension headers to interface with Xplained Pro extension boards for a rapid prototyping and expanded functionality. The figure below shows the PIC32CM JH01 Curiosity Pro evaluation kit.

**Figure 1. PIC32CM JH01 Curiosity Pro Evaluation kit**

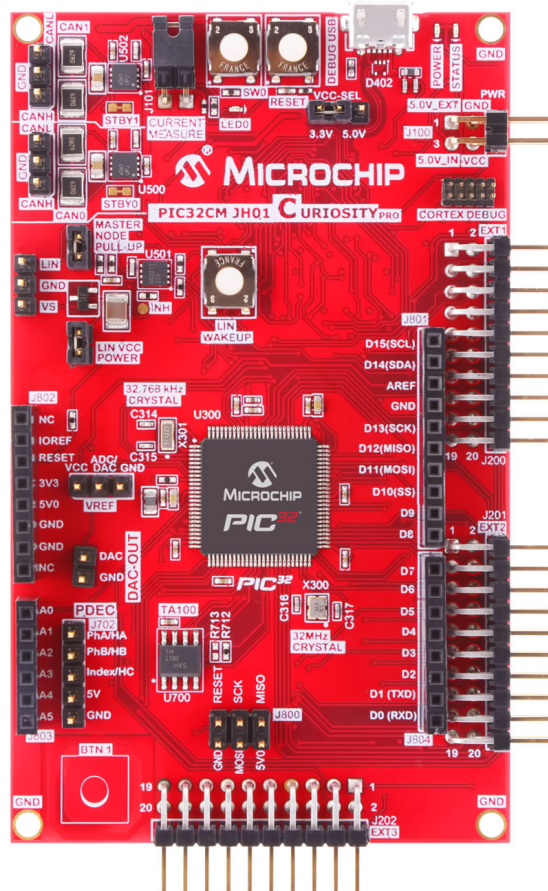

---

## Table of Contents

---

Preface.....	1
1. Introduction.....	3
1.1. Features.....	3
1.2. Overview.....	4
2. Getting Started.....	7
3. Curiosity Pro.....	8
3.1. Embedded Debugger.....	8
4. Hardware User Guide.....	9
4.1. Power Sources.....	9
4.2. Headers and Connectors.....	11
4.3. Peripherals.....	19
4.4. Kit Modifications.....	23
4.5. Embedded Debugger Implementation.....	29
5. Identifying Product ID and Revision.....	31
6. References.....	32
7. Revision History.....	33
The Microchip Website.....	34
Product Change Notification Service.....	34
Customer Support.....	34
Microchip Devices Code Protection Feature.....	34
Legal Notice.....	35
Trademarks.....	35
Quality Management System.....	36
Worldwide Sales and Service.....	37

## **1. Introduction**

### **1.1 Features**

The following are key features of the PIC32CM JH01 Curiosity Pro evaluation kit.

- 100-pin TQFP PIC32CM5164 JH01 microcontroller
- Embedded Debugger
  - micro-USB interface
  - Auto-ID for daughter board identification in MPLAB X IDE
  - One yellow status LED
  - One green board power LED
  - Symbolic debug of complex data types including scope information
  - Programming and debugging of on-board PIC32CM JH01 through Serial Wire Debug (SWD)
  - Data Gateway Interface: SPI, I<sup>2</sup>C, and four GPIOs
  - Virtual COM port (CDC)
  - Control of on-board power switch to protect connected extensions against high voltage
- Digital I/O
  - Two mechanical buttons (user and reset button)
  - One driven shield Touch button
  - One yellow user LED
  - Three extension headers compatible with a wide range of Xplained Pro extension kits
  - Arduino uno connector
- Two selectable target voltages
  - 3.3V
  - 5.0V
- Voltage Level Shifters between target section and EDBG section
- 32.768 kHz crystal mounted
- 32 MHz crystal mounted
- Trust Anchor (TA100) Secure Element
- Two CAN transceivers with jumpers for connection to external device or loopback between the two CAN interfaces
- LIN transceiver
  - Wake-up button
  - Host node pull-up jumper
  - Alternate LIN power jumper
- DAC output connector
- Analog voltage reference connector with filtered power supply
  - ADC/DAC VREF
- 5-pin Position Decoder (PDEC) connector
- Supported with application examples in MPLAB Harmony v3

## 1.2 Overview

The PIC32CM JH01 Curiosity Pro evaluation kit is a hardware platform to evaluate the Microchip PIC32CM JH01 microcontroller, and the evaluation kit part number is EV81X90A.

The evaluation kit offers a set of features that enables the PIC32CM JH01 users to get started with the PIC32CM JH01 peripherals, and to obtain an understanding of how to integrate the device in their own design. The following figure illustrates the top and bottom view of the PIC32CM JH01 Curiosity Pro evaluation kit.

Figure 1-1. PIC32CM JH01 Curiosity Pro Evaluation Kit Layout (Top View)

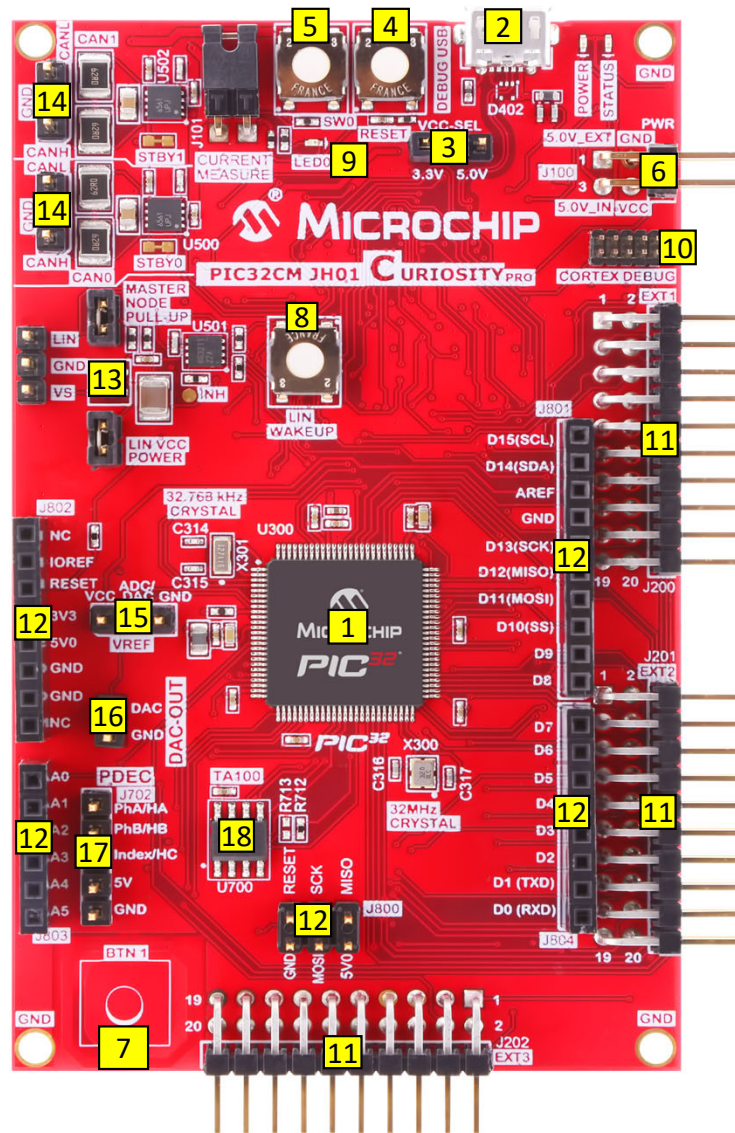

Figure 1-2. PIC32CM JH01 Curiosity Pro Evaluation Kit Layout (Bottom View)

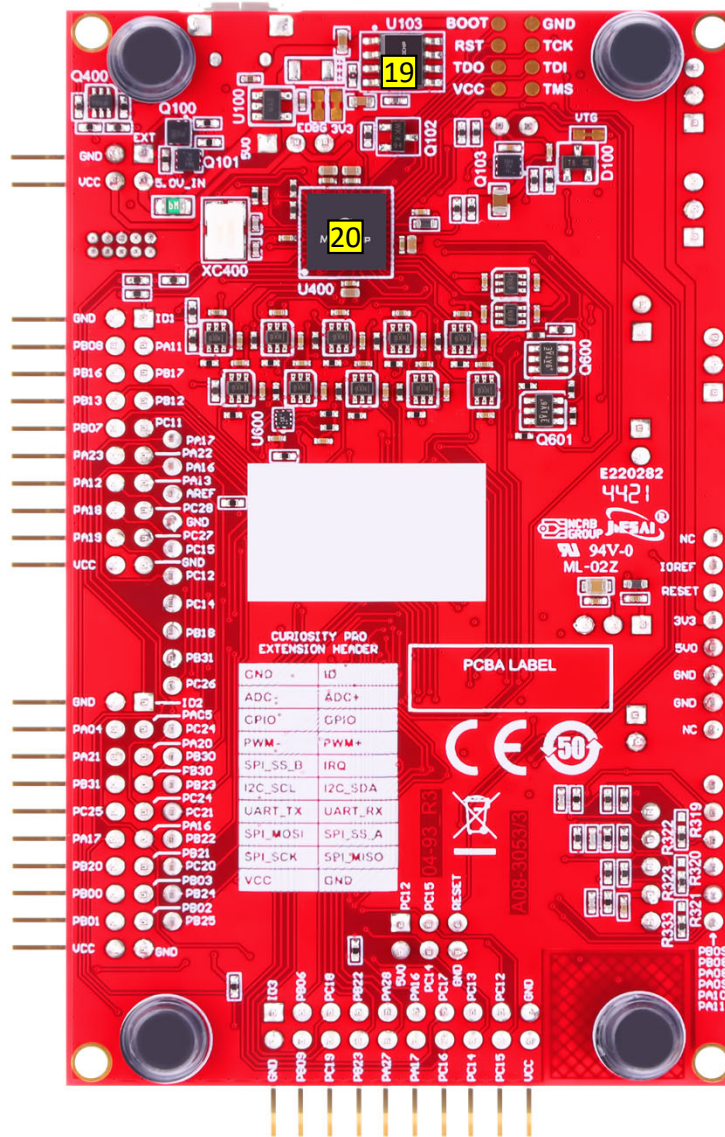

Table 1-1. PIC32CM JH01 Curiosity Pro Kit Features and Location

Number	Item Description
1	PIC32CM JH01
2	EDBG USB power supply
3	3-pin VCC Selection header (3.3V or 5.0V)
4	Reset button
5	Programmable button
6	Power header for external power sources
7	Touch button
8	LIN Wakeup button
9	User LED (Yellow)
10	10-pin Cortex® debug header (SWD)
11	Extension headers
12	Arduino Uno header connectors
13	LIN header
14	CAN headers
15	3-pin ADC/DAC VREF header
16	2-pin DAC output header
17	PDEC header connectors
18	Trust Anchor 100 (TA100) secure element
19	Target Voltage power switch with slew rate control
20	Embedded Debugger (EDBG)

Table 1-2. PIC32CM JH01 Curiosity Pro Evaluation Kit Microchip Total System Solutions (TSS)

TSS Component	Qty (Per Kit)	Function
PIC32CM5164JH01100-I/PF	1	Target MCU
MIC5504-3.3YM5-TR	1	3.3V, 300 mA LDO
MIC5209-3.3YM	1	3.3V, 500 mA LDO
AT32UC3A4256HHB-C1UR	1	EDBG Debugger
ATA6561-GBQW	2	CAN Transceiver
ATA663211-GBQW	1	LIN Transceiver
TA100-Y240C2X01-00B-VAO	1	TA100 Authentication Chip
VXM8-9015-32M0000000	1	Primary 32 MHz crystal
VMK3-9001-32K7680000TR	1	Secondary 32.768 kHz crystal



## 2. Getting Started

Follow these steps to explore the evaluation kit platform:

1. Download [MPLAB® X IDE](#).
2. Launch MPLAB X IDE.
3. Connect the DEBUG USB port on the evaluation kit to the computer using a USB cable (Standard-A to Micro-B or Micro-AB).

**Note:** When the evaluation kit is connected to the computer for the first time, the operating system will install the software driver. The driver file supports both 32-bit and 64-bit versions of Microsoft Windows XP®, Windows Vista®, Windows 7®, Windows 8®, Windows 10®, and Windows Server 2012®.

When the evaluation kit is powered, the green power LED will glow and MPLAB X IDE will auto-detect the specific Curiosity Pro evaluation kit and extension boards that are connected to it. MPLAB X IDE will present relevant information, such as data sheets and kit documentation.

The kit landing page in MPLAB X IDE also has an option to launch MPLAB Harmony v3 example applications for the kit.

The PIC32CM JH01 device is programmed and debugged by the on-board Embedded Debugger (EDBG), hence no external programmer or debugger tool is required.

**Note:** Users can connect external debugger tools using the Cortex-M Debug connector.

### 3. Curiosity Pro

The PIC32CM JH01 Curiosity Pro evaluation kit is a user-friendly rapid prototyping platform. It is supported with MPLAB X IDE and MPLAB Harmony v3 software development framework that comes with demonstration codes, middleware, PLIBs, and drivers.

The Curiosity Pro evaluation kits support a wide range of extension boards which are connected through a set of standardized headers and connectors. Each extension board has an identification (ID) chip to uniquely identify which boards are connected to the Curiosity Pro evaluation kit. When an extension board is connected, some relevant information, such as board features, supported interfaces, serial number, links to documentation, is read and displayed on the MPLAB X IDE window.

#### 3.1 Embedded Debugger

The PIC32CM JH01 Curiosity Pro evaluation kit contains the Microchip Embedded Debugger (EDBG) for on-board debugging. The EDBG is a composite USB device of the following three interfaces:

- Debugger
- Virtual COM Port
- Data Gateway Interface (DGI)

Together with MPLAB X IDE, the EDBG debugger interface programs and debugs the microcontroller. On the Curiosity Pro evaluation kit, the SWD interface is connected between the EDBG and the microcontroller.

The Virtual COM Port is connected to a UART on the PIC32CM JH01 and provides an easy way to communicate with the target application through terminal software. It offers variable baud rate, parity, and stop bit settings. The settings on the PIC32CM JH01 must match the settings given in the terminal software.

**Note:** The virtual COM port in the EDBG requires the terminal software to set the data terminal ready (DTR) signal to enable the UART pins connected to the PIC32CM JH01. If the DTR signal is not enabled, the UART pins on the EDBG are kept in high-z (tristate) rendering the COM port unusable. The DTR signal is set automatically by some terminal software, but it may have to be manually enabled in your terminal.

The DGI consists of several physical interfaces for communication with the Host computer. Communication over the interfaces is bidirectional. It can be used to send events and values from the PIC32CM JH01. Traffic over the interfaces can be timestamped by the EDBG for accurate tracing of events. time stamping imposes an overhead that reduces maximal throughput. The MPLAB Data Visualizer is used to send and receive data through DGI.

The EDBG controls two LEDs: a power LED and a status LED. The following table provides how LEDs are controlled in different operation modes.

**Table 3-1. EDBG LED Control**

Operation mode	Power LED	Status LED
Normal operation	Power LED is lit when power is applied to the kit.	Activity indicator, LED flashes when any communication happens to the EDBG.
Bootloader mode (idle)	The power LED and the status LED blink simultaneously.	
Bootloader mode (firmware upgrade)	The power LED and the status LED blink in an alternating pattern.	

For additional information on the EDBG, refer to the [Microchip EDBG User Guide](#).



## 4. Hardware User Guide

### 4.1 Power Sources

The PIC32CM JH01 Curiosity Pro evaluation kit can be powered by the following power sources:

- Embedded Debugger USB
- An external power

**Table 4-1. Power Sources**

Power input	Voltage requirements	Current requirements	Connector marking
External power	4.3V to 5.5V.	Recommended maximum is 2A due to the input protection maximum current specification.	PWR
Embedded debugger USB	4.4V to 5.25V (according to USB spec.)	500 mA (according to USB spec.)	DEBUG USB

The evaluation kit will automatically detect which power source is available, and choose which one to use according to the following priority:

- External power
- Embedded Debugger USB

**Note:** External power is required when 500 mA from a USB connector is not enough to power the evaluation kit with possible extension boards.

The EDBG controls an on-board power switch to the PIC32CM JH01, on-board peripherals, and extension connectors. When the kit is powered up, the EDBG reads the ID chip information from all connected extension boards and checks they are compatible with the voltage selected by the power selection jumper. If the selected voltage is within the connected extensions ranges, the switch will open. If not, the EDBG power LED will blink rapidly and the switch will stay closed resulting in no power provided to the PIC32CM JH01, on-board peripherals, and connectors.

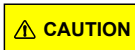

The evaluation kit can be powered by 5.0V. Care must be taken not to connect any extension board that does not support this voltage, as it might results in permanent damage. Check the respective extension kit's user guide to see which voltages are acceptable.



**Remember:** The EDBG only reads the ID information and controls the power switch when the kit is powered up. This mechanism does not check hot plugging of extension boards.

**Figure 4-1. Power Supply Block Diagram**

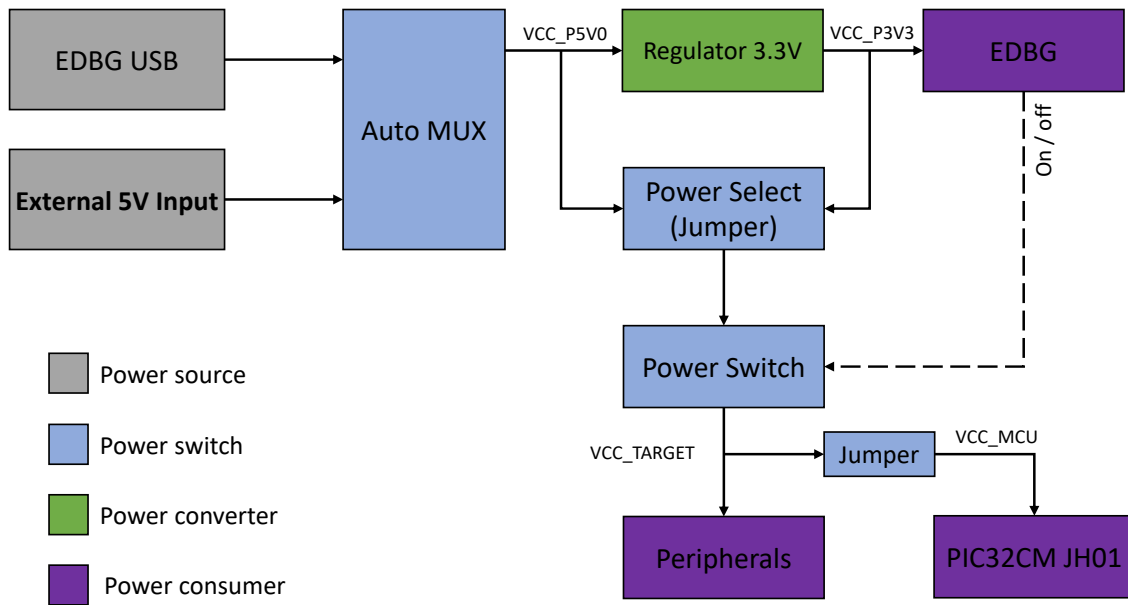

## 4.2 Headers and Connectors

The following sections describe the implementation of the relevant connectors and headers on the evaluation kit and their connection to the PIC32CM JH01 microcontroller. The tables of connections below also describe which signals are shared between the headers and on-board functionality.

### 4.2.1 Power Header

The power header can be used to connect external power to the Curiosity Pro evaluation kit. The kit will automatically detect and switch to any external power if supplied. The power header can also be used as supply for external peripherals or extension boards. Care must be taken not to exceed the total current limitation of the on-board regulator when using the 3.3V or 5.0V pin.

- External power
- Embedded Debugger USB

**Table 4-2. Power Header**

Pin number	Pin name	Description
1	5.0V_EXT	External 5V input
2	GND	Ground
3	5.0V_IN	Unregulated 5V (output, derived from one of the input sources)
4	VCC	Regulated 3.3V or 5.0V (output, used as main power supply for the kit)

All Curiosity Pro evaluation kits have one or more dual-row, 20-pin, 100 mil extension header (with a pitch of 2.54 mm), which can be used to connect a variety of extension boards to the kit, or to directly access the pins of the target. The Curiosity Pro evaluation kits have male headers, while extension boards have their female counterparts. All pins are not always connected, and all connected pins follow the defined pin-out description given in the table below.

**Table 4-3. Extension Header**

Pin number	Name	Description
1	ID	Communication line to the ID chip on an extension board
2	GND	Ground
3	ADC(+)	Analog-to-digital converter, alternatively positive part of differential ADC
4	ADC(-)	Analog-to-digital converter, alternatively negative part of differential ADC
5	GPIO0	General purpose I/O '0'
6	GPIO1	General purpose I/O '1'
7	PWM(+)	Pulse-Width-Modulation, alternatively positive part of differential PWM
8	PWM(-)	Pulse-Width-Modulation, alternatively negative part of differential PWM
9	IRQ/GPIO	Interrupt request line and general purpose I/O
10	SPI_SS_B/ GPIO	SPI select for general purpose I/O
11	I2C_SDA	Data line for I <sup>2</sup> C interface. Always implemented, bus type.
12	I2C_SCL	Clock line for I <sup>2</sup> C interface. Always implemented, bus type.
13	UART_RX	Receiver line of target device UART
14	UART_TX	Transmitter line of target device UART
15	SPI_SS_A	SPI select. Must preferably be unique.
16	SPI_MOSI	Host out Client in line of serial peripheral interface. Always implemented, bus type.

.....continued

Pin number	Name	Description
17	SPI_MISO	Host in Client out line of serial peripheral interface. Always implemented, bus type.
18	SPI_SCK	Clock for serial peripheral interface. Always implemented, bus type.
19	GND	Ground
20	VCC	Power for extension board

The evaluation kit's EXT1, EXT2, and EXT3 headers enable to expand the microcontroller's I/O through extension boards. These headers are based on the standard extension header and are specified in the following tables:

**Table 4-4. Extension Header EXT1**

EXT1 pin	PIC32CM JH01 pin	Function	Schematic Net Name	Shared Functionality
1 [ID]	-	-	-	Communication line to the ID chip on an extension board.
2 [GND]	GND	-	GND	Ground
3 [ADC(+)]	PA11	ADC0/AIN[11]	PA11_ADC(+)_A5	Arduino
4 [ADC(-)]	PB08	ADC0/AIN[2]	PB08_ADC(-)_A1	Arduino
5 [GPIO0]	PB17	GPIO	PB17_GPIO	-
6 [GPIO1]	PB16	GPIO	PB16_GPIO	-
7 [PWM(+)]	PB12	TCC0/WO[6]	PB12_PWM(+)	-
8 [PWM(-)]	PB13	TCC0/WO[7]	PB13_PWM(-)	-
9 [IRQ/GPIO]	PA21	EIC/EXTINT[5] / GPIO	PA21_GPIO	-
10 [SPI_SS_B/GPIO]	PB07	GPIO	PB07_SPI_SS_B/GPIO	-
11 [TWI_SDA]	PA22	SERCOM3/PAD[0] I <sup>2</sup> C SDA	PA22_I2C_SDA	-
12 [TWI_SCL]	PA23	SERCOM3/PAD[1] I <sup>2</sup> C SCL	PA23_I2C_SCL	-
13 [USART_RX]	PA13	SERCOM2/PAD[1] UART RX	PA13_UART_RX	-
14 [USART_TX]	PA12	SERCOM2/PAD[0] UART TX	PA12_UART_TX	-
15 [SPI_SS_A]	PC28	SERCOM1/PAD[1] SPI SS	PC28_SPI_SS_A	-
16 [SPI_MOSI]	PA18	SERCOM1/PAD[2] SPI MOSI	PA18_SPI_MOSI	-
17 [SPI_MISO]	PC27	SERCOM1/PAD[0] SPI MISO	PC27_SPI_MISO	-
18 [SPI_SCK]	PA19	SERCOM1/PAD[3] SPI SCK	PA19_SPI_SCK	-
19 [GND]	-	-	GND	Ground.

.....continued

EXT1 pin	PIC32CM JH01 pin	Function	Schematic Net Name	Shared Functionality
20 [VCC]	-	-	-	Power for extension board.

**Table 4-5. Extension Header EXT2**

EXT2 pin	PIC32CM JH01 pin	Function	Schematic Net Name	Shared functionality
1 [ID]	-	-	-	Communication line to the ID chip on an extension board.
2 [GND]	GND	-	GND	Ground
3 [ADC(+)]	PA05	ADC0/AIN[5]	PA05_ADC(+)	-
4 [ADC(-)]	PA04	ADC0/AIN[4]	PA04_ADC(-)	-
5 [GPIO0]	PA20	GPIO	PA20_GPIO	-
6 [GPIO1]	PC11	GPIO	PC11_IRQ/GPIO	-
7 [PWM(+)]	PB30	TCC1/WO[2]	PB30_PWM(+)_PWM/D6	Arduino
8 [PWM(-)]	PB31	TCC1/WO[3]	PB31_PWM(-)_PWM/D9	Arduino
9 [IRQ/GPIO]	PC24	EIC/EXTINT[0] / GPIO	PC24_IRQ/GPIO_D7	-
10 [SPI_SS_B/GPIO]	PC25	GPIO	PC25_SPI_SS_B/GPIO	-
11 [TWI_SDA]	PA16	SERCOM1/PAD[0] I <sup>2</sup> C SDA	PA16_I2C_SDA	EXT3, EDBG DGI, Arduino
12 [TWI_SCL]	PA17	SERCOM1/PAD[1] I <sup>2</sup> C SCL	PA17_I2C_SCL	EXT3, EDBG DGI, Arduino
13 [USART_RX]	PB21	SERCOM3/PAD[1] UART RX	PB21_UART_RX	-
14 [USART_TX]	PB20	SERCOM3/PAD[0] UART TX	PB20_UART_TX	-
15 [SPI_SS_A]	PB03	SERCOM5/PAD[1] SPI SS	PB03_SPI_SS_A	-
16 [SPI_MOSI]	PB00	SERCOM5/PAD[2] SPI MOSI	PB00_SPI_MOSI	TA100
17 [SPI_MISO]	PB02	SERCOM5/PAD[0] SPI MISO	PB02_SPI_MISO	TA100
18 [SPI_SCK]	PB01	SERCOM5/PAD[3] SPI SCK	PB01_SPI_SCK	TA100
19 [GND]	-	-	GND	Ground.
20 [VCC]	-	-	-	Power for extension board.

**Table 4-6. Extension Header EXT3**

EXT3 pin	PIC32CM JH01 pin	Function	Schematic Net Name	Shared functionality
1 [ID]	-	-	-	Communication line to the ID chip on an extension board.
2 [GND]	GND	-	GND	Ground
3 [ADC(+)]	PB06	ADC1/AIN[8]	PB06_ADC(+)	-
4 [ADC(-)]	PB09	ADC1/AIN[5]	PB09_ADC(-)_A0	Arduino
5 [GPIO0]	PC18	GPIO	PC18_GPIO	-
6 [GPIO1]	PC19	GPIO	PC19_GPIO	-
7 [PWM(+)]	PB22	TC3/WO[0]	PB22_PWM(+)	Arduino
8 [PWM(-)]	PB23	TC3/WO[1]	PB23_PWM(-)	Arduino
9 [IRQ/GPIO]	PA28	EIC/EXTINT[8] / GPIO	PA28_IRQ/GPIO	-
10 [SPI_SS_B/GPIO]	PA27	GPIO	-	-
11 [TWI_SDA]	PA16	SERCOM1/PAD[0] I <sup>2</sup> C SDA	PA16_I2C_SDA	EXT2, EDBG DGI, Arduino
12 [TWI_SCL]	PA17	SERCOM1/PAD[1] I <sup>2</sup> C SCL	PA17_I2C_SCL	EXT2, EDBG DGI, Arduino
13 [USART_RX]	PC17	SERCOM6/PAD[1] UART RX	PC17_UART_RX	-
14 [USART_TX]	PC16	SERCOM6/PAD[0] UART TX	PC16_UART_TX	-
15 [SPI_SS_A]	PC13	SERCOM7/PAD[1] SPI SS	PC13_SPI_SS_A	-
16 [SPI_MOSI]	PC14	SERCOM7/PAD[2] SPI MOSI	PC14_SPI_MOSI	EDBG DGI, Arduino
17 [SPI_MISO]	PC12	SERCOM7/PAD[0] SPI MISO	PC12_SPI_MISO	EDBG DGI, Arduino
18 [SPI_SCK]	PC15	SERCOM7/PAD[3] SPI SCK	PC15_SPI_SCK	EDBG DGI, Arduino
19 [GND]	-	-	GND	Ground
20 [VCC]	-	-	-	Power for extension board.

### 4.2.2 Arduino Uno™ Header Connectors

The PIC32CM JH01 Curiosity Pro evaluation kit implements Arduino shield connectors based on the [Arduino Uno](#). All references to the Arduino pin names are taken from the official [Arduino schematics](#) of the Arduino Uno.



The target section of the evaluation kit can be powered by 3.3V or 5.0V. The maximum voltage to the I/O pins can tolerate depends on the supply voltage. Providing higher voltages, such as 5V to an I/O pin, when the PIC32CM JH01 is powered by 3.3V can damage the kit.



**Remember:** All pins do not have the same functionality on the Arduino Uno as on the shield connectors. Each shield should be checked for compatibility before it is connected.

**Table 4-7. J802 - Arduino Power**

J802 pin	PIC32CM JH01 pin	Arduino pin name	Function	Shared functionality
1	-	RFU	Not Connected	-
2	-	IOREF	VCC_P5V0	-
3	RESETN	RESET	TARGET_RESET	EDBG SWD, Cortex Debug, Arduino, RESET button
4	-	3.3V	VCC_P3V3	-
5	-	5.0V	VCC_P5V0	-
6	-	GND	GND	-
7	-	GND	GND	-
8	-	VIN	Not Connected	-

**Table 4-8. J803 - Arduino Analog**

J803 pin	PIC32CM JH01 pin	Arduino pin name	Function	Schematic Net Name	Shared functionality
1	PB09	A0	ADC1/AIN[5]	PB09_ADC(+)_A0	EXT3
2	PB08	A1	ADC0/AIN[2]	PB08_ADC(-)_A1	EXT1
3	PA08	A2	ADC0/AIN[8]	PA08_A2	PDEC_PhaseA <sup>(1)</sup>
4	PA09	A3	ADC0/AIN[9]	PA09_A3	PDEC_PhaseB <sup>(1)</sup>
5	PA10	A4	ADC0/AIN[10]	PA10_A4	PDEC_Index <sup>(1)</sup>
6	PA11	A5	ADC0/AIN[11]	PA11_ADC(+)_A5	EXT1

**Note:**

1. Only PDEC or Arduino (A2, A3, A4) mode must be used at a single time.



**Table 4-9. J804 - Arduino Digital Low**

J804 pin	PIC32CM JH01 pin	Arduino pin name	Function	Schematic Net Name	Shared functionality
1	PB25	RX/D0	SERCOM0/PAD[1] UART RX	PB25_RX/D0	-
2	PB24	TX/D1	SERCOM0/PAD[0] UART TX	PB24_TX/D1	-
3	PC20	D2	GPIO	PC20_D2	-
4	PB22	PWM/D3	TC3/WO[0]	PB22_PWM/D3	EXT3
5	PC21	D4	GPIO	PC21_D4	-
6	PB23	PWM/D5	TC3/WO[1]	PB23_PWM/D5	EXT3
7	PB30	PWM/D6	TCC1/WO[2]	PB30_PWM(+)_PWM/D6	EXT2
8	PC24	D7	EIC/EXTINT[0] / GPIO	PC24_IRQ/GPIO_D7	EXT2

**Table 4-10. J801 - Arduino Digital High**

J801 pin	PIC32CM JH01 pin	Arduino pin name	Function	Schematic Net Name	Shared functionality
1	PC26	D8	GPIO	PC26_D8	-
2	PB31	PWM/D9	TCC1/WO[3]	PB31_PWM(-)_PWM/D9	EXT2
3	PB18	PWM/D10	GPIO	PB18_PWM/D10/SPI_SS	-
4	PC14	PWM/D11	SERCOM7/PAD[2] SPI MOSI	PC14_SPI_MOSI	EXT3, EDBG DGI
5	PC12	D12	SERCOM7/PAD[0] SPI MISO	PC12_SPI_MISO	EXT3, EDBG DGI
6	PC15	D13	SERCOM7/PAD[3] SPI SCK	PC15_SPI_SCK	EXT3, EDBG DGI
7	GND	GND	-	GND	Ground
8	PA03	AREF	-	PA03_ADC_DAC_VREF	-
9	PA16	SDA/D14	SERCOM1/PAD[0] I <sup>2</sup> C SDA	PA16_I2C_SDA	EXT2, EXT3, EDBG DGI
10	PA17	SCL/D15	SERCOM1/PAD[1] I <sup>2</sup> C SCL	PA17_I2C_SCL	EXT2, EXT3, EDBG DGI

**Table 4-11. J800 - Arduino SPI**

J800 pin	PIC32CM JH01 pin	Arduino pin name	Function	Schematic Net Name	Shared functionality
1	PC12	SPI_MISO/D12	SERCOM7/PAD[0] SPI MISO	PC12_SPI_MISO	EXT3, EDBG DGI
2	-	5V	VCC_P5V0		-
3	PC15	SPI_SCK/D13	SERCOM7/PAD[3] SPI SCK	PC15_SPI_SCK	EXT3, EDBG DGI
4	PC14	SPI_MOSI/D11	SERCOM7/PAD[2] SPI MOSI	PC14_SPI_MOSI	EXT3, EDBG DGI
5	RESETN	RESET	-	TARGET_RESET	EDBG SWD, Cortex Debug, Arduino, RESET button
6	-	GND	-	GND	Ground

### 4.2.3 PDEC Connector

The evaluation kit has a 5-pin mounted connector for the position decoder module. The PDEC can be used for quadrature, hall, and counter decoding.

**Note:** External pull-ups are mounted on the three signal lines for using with passive quadrature encoders.

**Table 4-12. J702 - PDEC Connector**

J702 pin	PIC32CM JH01 pin	PDEC pin name	Function	Schematic Net Name	Shared functionality
1	PA08	PDEC_PhaseA <sup>(1)</sup>	QDI[0]	PA08_PDEC_PhaseA_A2	Arduino
2	PA09	PDEC_PhaseB <sup>(1)</sup>	QDI[1]	PA09_PDEC_PhaseB_A3	Arduino
3	PA10	PDEC_Index <sup>(1)</sup>	QDI[2]	PA10_PDEC_Index_A4	Arduino
4	-	5V	VCC_P5V0	VCC_P5V0	-
5	GND	Ground	-	GND	Ground

**Note:**

1. Only PDEC or Arduino (A2, A3, A4) modes must be used at a single time.

### 4.2.4 VCC Selection Header

The evaluation kit has a 3-pin header, labeled VCC\_SEL. This header can be used to select between 3.3V and 5.0V as the supply voltage for the PIC32CM JH01, peripherals, and extension headers by placing a jumper on the pin 1-2 or pin 2-3. Selecting 5.0V will supply the kit directly from the USB connector, or an external 5.0V source. Selecting 3.3V will supply the kit from an on-board regulator.

**Table 4-13. J102 - VCC-Select Header**

VCC_SEL header pin	Function
1	VCC_P5V0
2	VCC_TARGET
3	VCC_P3V3

### 4.2.5 ADC/DAC VREF Header

The evaluation kit has a 3-pin header labeled VREF. This header can be used to select and apply a voltage reference to the ADC and DAC. A jumper can be used to tie the ADC/DAC VREF to a filtered kit target voltage from the pin 1-2, or an external voltage can be applied across the pin 2-3.

**Table 4-14. J701 - ADC/DAC VREF Header**

VREF header pin	Pin/Net	Function	Schematic Net Name	Shared Functionality
1	VCC_AREF_P3V3_P5V0	Filtered kit target voltage	VCC_AREF_P3V3_P5V0	-
2	PA03	ADC / DAC voltage reference	PA03_ADC_DAC_VREF	-
3	GND	-	GND	Ground

### 4.2.6 DAC Header

The evaluation kit has a 2-pin header labeled DAC-OUT on the board that is connected to the DAC output of the PIC32CM JH01 and ground.

**Table 4-15. J700 - DAC Output Header**

DAC header pin	Pin / Net	Function	Schematic Net Name	Shared functionality
1	PA02	DAC output	PA02_DAC_OUTPUT	-
2	GND	-	GND	Ground

### 4.2.7 Current Measurement Header

An angled 1x2, 100 mil pin-header labeled CURRENT MEASURE is located at the upper edge of the evaluation kit. All power to the PIC32CM JH01 is routed through this header. To measure the power consumption of the device, remove the jumper and replace it with an ammeter.

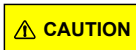

Removing the jumper from the pin-header while the evaluation kit is powered may cause the PIC32CM JH01 to be powered through its I/O pins. This may cause permanent damage to the device.

### 4.2.8 Cortex Debug Connector

The evaluation kit has a 10-pin 50-mil Cortex® Debug Connector that can be used to attach external debuggers to the PIC32CM JH01.

**Table 4-16. J203 - Cortex Debug Connector**

Cortex Debug Connector pin	Pin / Net	Function	Shared Functionality
1	VCC_TARGET_P3V3_P5V0	PIC32CM JH01 Curiosity Pro Evaluation kit voltage	-
2	PA31 / SWDIO	SWD data signal	EDBG SWD
3	GND	Ground	-
4	PA30 / SWCLK	SWD clock signal	EDBG SWD
5	GND	Ground	-
6	Not Connected	-	-
7	Not Connected	-	-

.....continued

Cortex Debug Connector pin	Pin / Net	Function	Shared Functionality
8	Not Connected	-	-
9	GND	Ground	-
10	RESET	Target reset signal	EDBG SWD, Arduino, RESET button, TA100

## 4.3 Peripherals

### 4.3.1 LED

One yellow LED is available on the evaluation kit that can be turned on and off. The LED is activated by driving the connected I/O line to low.

**Table 4-17. D700 - LED Connection**

PIC32CM JH01 pin	Function	Silkscreen Text	Schematic Net Name	Shared functionality
PC05	Yellow LED0	LED0	PC05_USER_LED	-

### 4.3.2 Mechanical Buttons

The evaluation kit contains two mechanical buttons connected to the PIC32CM JH01. One button is the RESET button connected to the reset line, and the other is a generic user configurable button. When a button is pressed, it will drive the I/O line to GND.

**Table 4-18. Mechanical Buttons**

PIC32CM JH01 pin	Function	Silkscreen Text	Schematic Net Name	Shared functionality
RESETN	Reset	RESET	TARGET_RESET	EDBG SWD, Cortex Debug, Arduino, TA100
PB19	GPIO	SW0	PB19_USER_BUTTON	-

### 4.3.3 Crystals

The evaluation kit contains one mounted 32.768 kHz crystal and one mounted 32 MHz crystal that can be used as clock sources for the PIC32CM JH01.

**Table 4-19. X301 - External 32.768 kHz Crystal**

PIC32CM JH01 pin	Function	Schematic Net Name	Shared functionality
PA00	XIN32	PA00_XIN32	-
PA01	XOUT32	PA01_XOUT32	-

**Table 4-20. X300 - External 32 MHz Crystal**

PIC32CM JH01 pin	Function	Schematic Net Name	Shared functionality
PA14	XIN	PA14_XIN	-
PA15	XOUT	PA15_XOUT	-

#### 4.3.4 CAN

The PIC32CM JH01 has two CAN modules that perform communications according to ISO11898-1 (Bosch CAN specification 2.0 part A,B) and Bosch CAN FD specification V1.0.

Each CAN (CAN0 and CAN1) are connected to an on-board [ATA6561 CAN](#) physical-layer transceiver. The following table shows the connections between the PIC32CM JH01 and the ATA6561.

The CAN differential signals are connected to a 1 x 3, 100 mil pin-header labeled CAN.

**Table 4-21. U500 - CAN0 Connections**

PIC32CM JH01 pin	Function	Schematic Net Name	ATA6561 function	Shared functionality
PA24	CAN0/TX	PA24_CAN0_TX	TXD	-
PA25	CAN0/RX	PA25_CAN0_RX	RXD	-

**Table 4-22. U502 - CAN1 Connections**

PIC32CM JH01 pin	Function	Schematic Net Name	ATA6561 function	Shared functionality
PB14	CAN1/TX	PB14_CAN1_TX	TXD	-
PB15	CAN1/RX	PB15_CAN_RX	RXD	-

**Table 4-23. J500 - J505 - CAN Headers**

CAN Header Pin	Function
1	CANH
2	GND
3	CANL

### 4.3.5 LIN

The [ATA663211](#) LIN transceiver is mounted on the kit to convert the LIN signals from the SERCOM module in the PIC32CM JH01 device. The LIN compatible signals are available as a 3-pin header.

**Table 4-24. U501 - LIN Transceiver**

PIC32CM JH01 pin	Function	Schematic Net Name	ATA663211 function	Shared functionality
PA07	SERCOM0/PAD[3] LIN RX	PA07_LIN_RX	RXD	-
PC06	GPIO LIN EN	PC06_LIN_EN	EN	-
PA06	SERCOM0/PAD[2] LIN TX	PA06_LIN_TX	TXD	-

**Table 4-25. J503 - LIN Header**

LIN Header Pin	Function
1	VS
2	GND
3	LIN

**Table 4-26. J501 - Host Node Pull-Up Enable Header**

LIN Header Pin	Function
1	LIN
2	1kΩ pull-up to VS

**Table 4-27. J502 - LIN VCC Power**

LIN Header Pin	Function
1	VS
2	VCC_TARGET_P3V3_P5V0

### 4.3.6 Touch Button

One self-capacitance button is available on the evaluation kit that can be used as an I/O. This Touch button is intended to be driven by the built-in Peripheral Touch Controller (PTC) of the device.

**Note:** To get started with Touch, refer to [MPLAB Harmony 3 Touch library](#).

**Table 4-28. Touch Connection**

PIC32CM JH01 pin	Function	Silkscreen text	Schematic Net Name	Shared Functionality
PB04	Self-capacitance Touch button	BTN 1	PB04_T_BUTTON	-
PB05	Touch button driven shield	-	PB05_T_BUTTON_SHLD	-

### 4.3.7 Trust Anchor 100 (TA100) Secure Element

The TA100 Secure Element device requires a SPI interface to work and communicate with the PIC32CM JH01. The following table shows all the connections between the TA100 and the PIC32CM JH01.

**Table 4-29. U700 - TA100 Connections**

TA100 pin	PIC32CM JH01 pin	Function	Schematic Net Name	Shared functionality
1	PC08	GPIO SPI SS	PC08_TA100_SPI_SS	-
2	RESET	Target reset signal through R712	TARGET_RESET_SENSE	PC07_TA100_RESET through R713 not mounted
3	PC10	GPIO3	PC10_TA100_GPIO3	-
4	GND	Ground	GND	-
5	PB00	SERCOM5/ PAD[2] SPI MOSI	PB00_TA100_SPI_MOSI	EXT2
6	PB01	SERCOM5/ PAD[3] SPI SCK	PB01_TA100_SPI_SCK	EXT2
7	PB02	SERCOM5/ PAD[0] SPI MISO	PB02_TA100_SPI_MISO	EXT2
8	VCC_TARGET_P3V3_P5V0	-	VCC_TARGET_P3V3_P5V0	-



## 4.4 Kit Modifications

The evaluation kit has several resistors and jumpers that can be removed or cut to disconnect the I/O pins of the PIC32CM JH01 from the connectors and the on-board ICs to disconnect and measure power to different sections.

**Table 4-30. Resistors**

Designator	From	To	Comment
R319	PA08	PDEC_PhaseA	Remove when PA08, PA09 and PA10 are used in Arduino mode. Not mounted by default
R320	PA09	PDEC_PhaseB	
R321	PA10	PDEC_Index	
R322	PA08	ANALOG_IN A2	Remove when PA08, PA09 and PA10 are used in PDEC mode.
R323	PA09	ANALOG_IN A3	
R333	PA10	ANALOG_IN A4	
R609	RESET	RESET NET	Remove to disconnect the RESET pin from the reset system.
R607	PB11	CDC RX	Remove to disconnect pins from the EDBG level shifters.
R610	RESET NET	EDBG RESET	
R611	PA31	EDBG SWDIO	
R612	PA30	EDBG SWCLK	
R614	PC12 MISO	EDBG MISO	
R618	PC00	EDBG GPIO0	
R619	PC03	EDBG GPIO1	
R620	PC02	EDBG GPIO2	
R621	PC01	EDBG GPIO3	
R712	RESET NET	TA100 RESET	
R713	PC07	TA100 RESET	Remove to disable TA100 RESET through the PC07 pin.
R800	RESETN	Arduino shield RESET	Remove to disconnect the reset system from the Arduino shield connectors.

The following figures illustrate the top and bottom view of the resistors.

**Figure 4-2. Resistors (Top View)**

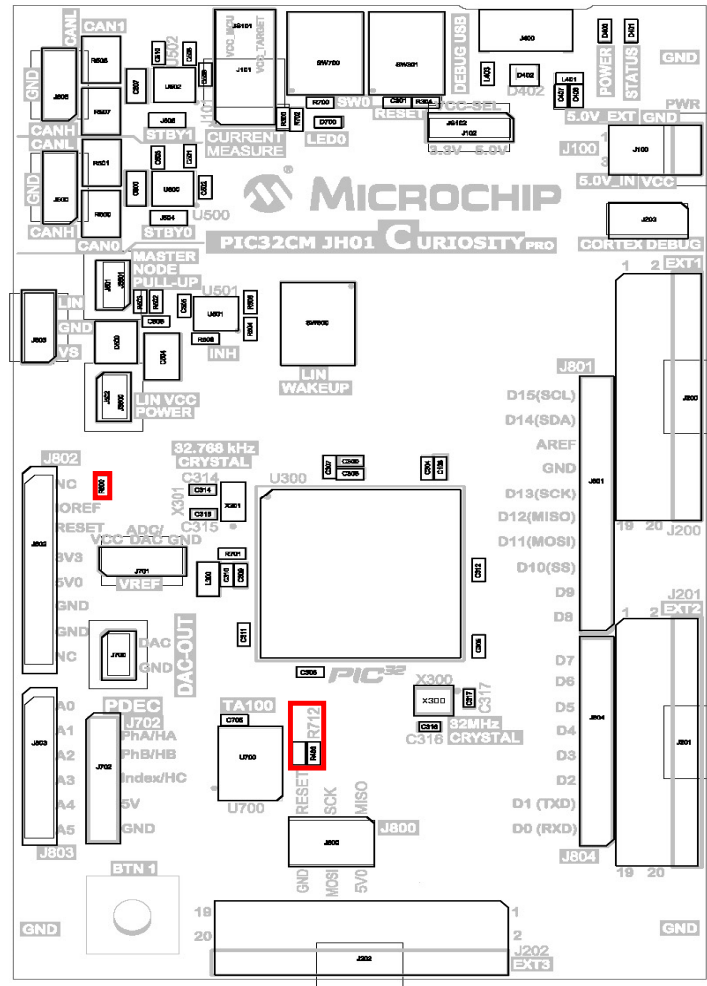

**Figure 4-3. Resistors (Bottom View)**

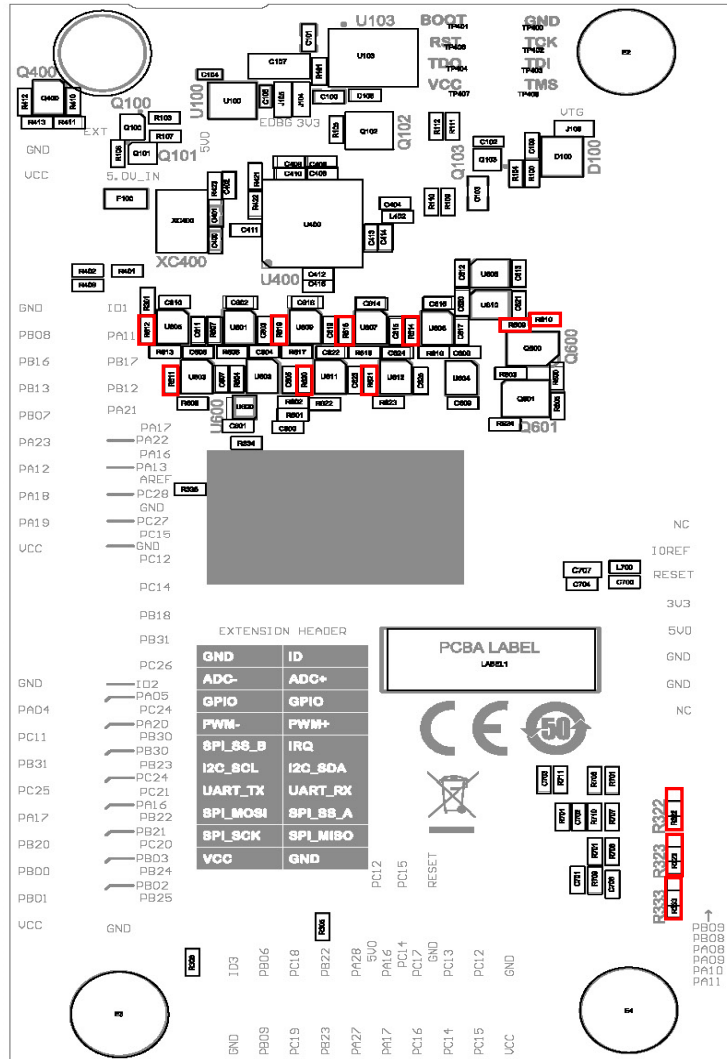

**Table 4-31. Jumpers**

Designator	From	To	Comment
J101	VCC_TARGET_X_P3V3_P5V0	VCC_TARGET_P3V3_P5V0	Remove this jumper (JS100) to measure current to the MCU section
J102	VCC_P5V0 (pin 1) and VCC_P3V3 (pin 3)	VCC_TARGET_SWITC H_P3V3_P5V0	Use this jumper (JS101) to select either 5.0V or 3.3V voltage to the Target section. Default setting in production is 5.0V.
J104	3.3V linear regulator output for Target section	VCC_P3V3	Cut this jumper to measure current to the Target and MCU sections.
J105	3.3V linear regulator output for EDBG section	VCC_EDBG_P3V3	Cut this jumper to measure current to the EDBG sections.
J106	VCC_TARGET_X_P3V3_P5V0	VCC_TARGET_P3V3_P5V0	Cut this jumper to measure current to the Target section.
J501	LIN Host Node	Pull-up resistor to VS voltage	Mount this jumper (JS501) to set the LIN transceiver as Host Node Pull-Up. Default setting in production is mounted.
J502	VS_LIN	VCC_TARGET_P3V3_P5V0	Mount this jumper (JS500) to power the LIN transceiver from VCC_TARGET_P3V3_P5V0. Remove this jumper when the LIN transceiver is powered from the LIN bus. Default setting in production is mounted.
J504	CAN 0 device, Standby pin	GND	Cut this jumper to explore the standby functionality of the CAN 0 transceiver (ATA6561).
J506	CAN 1 device, Standby pin	GND	Cut this jumper to explore the standby functionality of the CAN 1 transceiver (ATA6561).

The following figures illustrates the top and bottom view of the jumpers.

**Figure 4-4. Jumpers (Top View)**

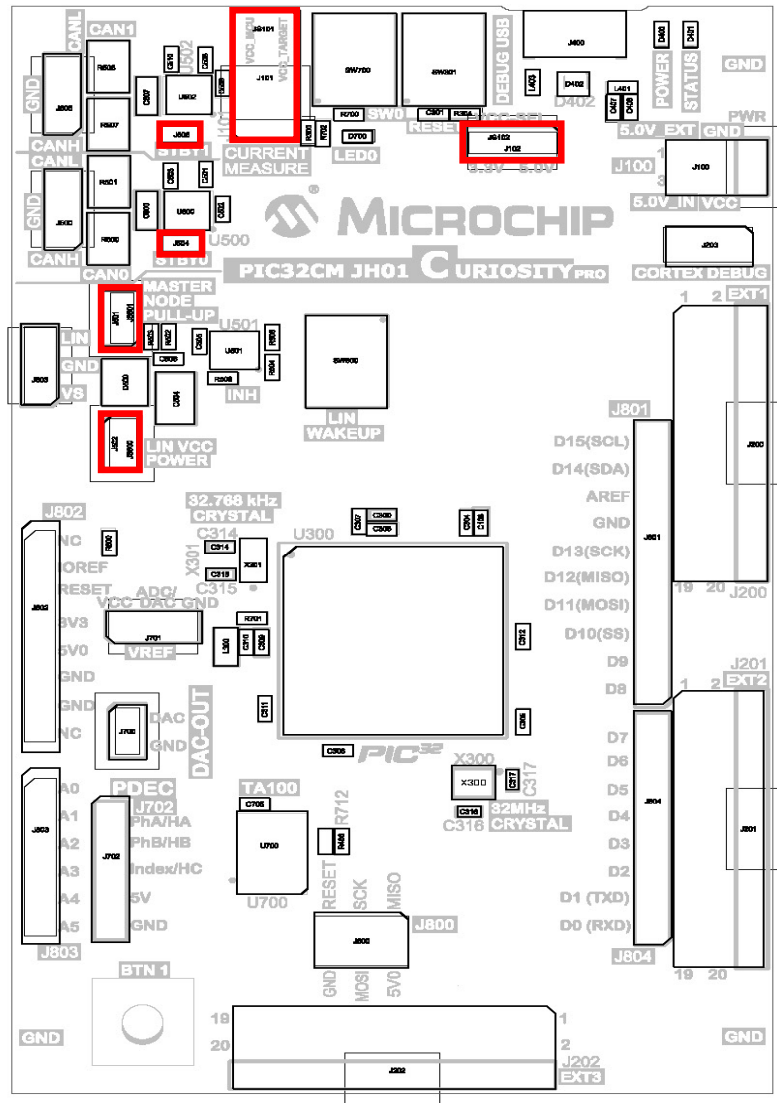
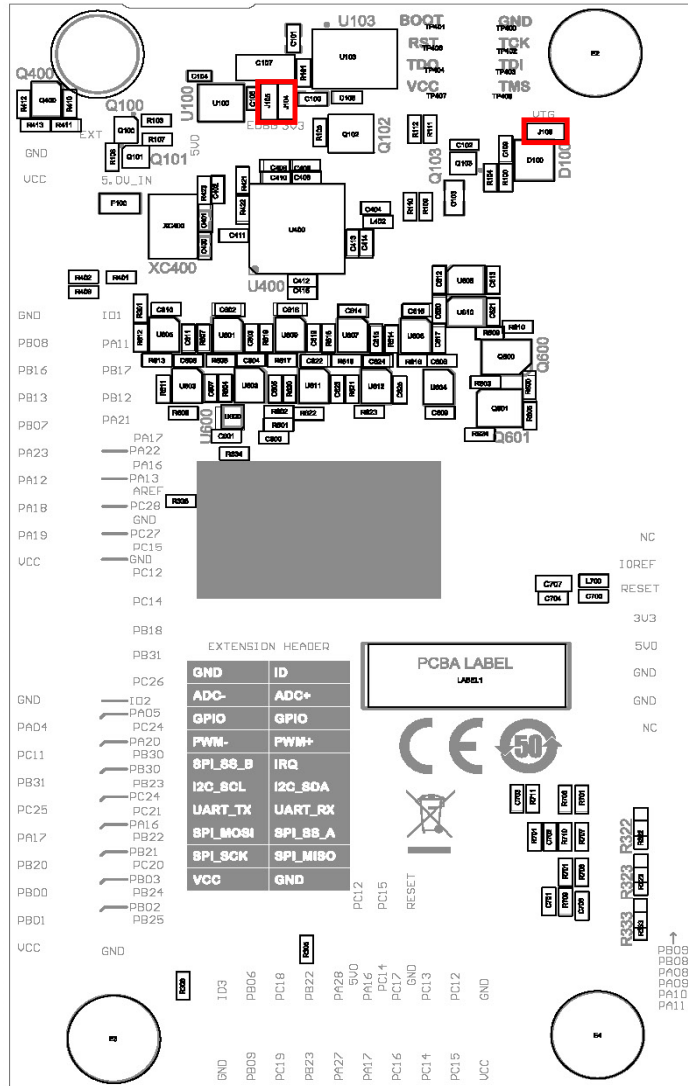

Figure 4-5. Jumpers (Bottom View)



## 4.5 Embedded Debugger Implementation

The evaluation kit contains an Embedded Debugger (EDBG) that can be used to program and debug the PIC32CM JH01 using Serial Wire Debug (SWD). The Embedded Debugger also includes a Virtual COM port interface over the UART, a Data Gateway Interface over SPI, TWI (I<sup>2</sup>C), and four of the PIC32CM JH01 GPIOs.

MPLAB X IDE can be used as a front end for the Embedded Debugger.

### 4.5.1 Serial Wire Debug

The Serial Wire Debug (SWD) uses two pins to communicate with the target. For additional information on using the programming and debugging capabilities of the EDBG, refer to the [Embedded Debugger User Guide](#).

**Table 4-32. SWD Connections**

PIC32CM JH01 pin	Function	Schematic Net Name	Shared Functionality
RESET	Reset	TARGET_RESET	RESET button, Arduino, Cortex Debug RESET, TA100
PA30	Serial Wire Clock	SWCLK	Cortex Debug SWCLK
PA31	Serial Wire Data IN/OUT	SWDIO	Cortex Debug SWDIO

### 4.5.2 Virtual COM Port

The Embedded Debugger acts as a Virtual COM Port gateway by using one of the PIC32CM JH01 UARTs. For additional information on using the Virtual COM port, refer to the [Embedded Debugger User Guide](#).

**Table 4-33. Virtual COM Port Connections**

PIC32CM JH01 pin	Function	Schematics Net Name	Shared functionality
PB10	SERCOM4/PAD[2] UART TX	PB10_CDC_UART_TX	-
PB11	SERCOM4/PAD[3] UART RX	PB11_CDC_UART_RX	-

### 4.5.3 Data Gateway Interface

The Embedded Debugger features a Data Gateway Interface (DGI) by using either a SPI or I<sup>2</sup>C interface. The DGI can be used to send a variety of data from the PIC32CM JH01 to the Host PC. For additional information on using the DGI interface, refer to the [Data Gateway Interface User's Guide](#) and [Embedded Debugger User Guide](#).

**Table 4-34. DGI Interface Connections When Using SPI**

PIC32CM JH01 pin	Function	Schematic Net Name	Shared functionality
PC09	GPIO SPI SS	PC09_DGI_SPI_LEVEL (SS)	-
PC12	SERCOM7/PAD[0] SPI MISO	PC12_SPI_MISO	EXT3, Arduino
PC14	SERCOM7/PAD[3] SPI SCK	PC15_SPI_SCK	EXT3, Arduino
PC15	SERCOM7/PAD[2] SPI MOSI	PC14_SPI_MOSI	EXT3, Arduino

**Table 4-35. DGI Interface Connections When Using I<sup>2</sup>C**

PIC32CM JH01 pin	Function	Schematic Net Name	Shared functionality
PA16	SERCOM1/PAD[0] I <sup>2</sup> C SDA	PA16_I2C_SDA	EXT2, EXT3, Arduino
PA17	SERCOM1/PAD[1] I <sup>2</sup> C SCL	PA17_I2C_SCL	EXT2, EXT3, Arduino

Four GPIO lines are connected to the Embedded Debugger. The EDBG can monitor these lines and time stamp pin value changes. This makes it possible to accurately time stamp events in the PIC32CM JH01 application code.



**Table 4-36. GPIO Lines Connected to the EDBG**

PIC32CM JH01 pin	Function	Schematic Net Name	Shared functionality
PC00	DGI_GPIO0	PC00_DGI_GPIO0	-
PC03	DGI_GPIO1	PC03_DGI_GPIO1	-
PC02	DGI_GPIO2	PC02_DGI_GPIO2	-
PC01	DGI_GPIO3	PC01_DGI_GPIO3	-

## 5. Identifying Product ID and Revision

The revision and product identifier of the Curiosity Pro evaluation kits can be identified by their unique serial number, either using MPLAB X IDE or by looking at the sticker at the bottom of the PCB.

By connecting the evaluation kit to a computer with MPLAB X IDE running, an information window containing the kit details, such as its serial number or its connected Xplained Pro extension board details will be displayed.

The evaluation kit serial number string has the following format: MCHPnnnnrrsssssssss

Where,

n = Product Identifier

r = Revision

s = Board number

**Table 5-1. PIC32CM JH01 Curiosity Pro Evaluation Kit Product Identifiers**

Family	Product Identifier
PIC32CM JH01	3053

## **6. References**

- PIC32CM JH00/JH01 Family Data Sheet (DS60001632)
- PIC32CM JH00/JH01 Family Silicon Errata and Data sheet Clarifications (DS80001000)

## 7. Revision History

### Revision B - 07/2022

The following updates were incorporated for this revision:

- Updated the following figures with new board images:
  - [Figure 1](#)
  - [Figure 1-1](#)
  - [Figure 1-2](#)
  - [Figure 4-2](#)
  - [Figure 4-3](#)
  - [Figure 4-4](#)
  - [Figure 4-5](#)
- Updated the values for EXT1 pin 9 and EXT2 pin 6 in [Curiosity Pro Power Header](#)
- Added a new row to table 4-20 for pin PA15 in [Crystals](#)
- Updated the values for TA100 pin 2 in [Trust Anchor 100 \(TA100\) Secure Element](#)
- Updated Resistor values for R713 in [Kit Modifications](#)

### Revision A - 11/2021

This is the initial release of this document.

Terminology in this document may not match with the contents of the current revision of the device data sheet or other Microchip documentation and collateral. If there are any questions or concerns regarding terminology, please contact a Microchip Support or Sales Representative.

---

## The Microchip Website

---

Microchip provides online support via our website at [www.microchip.com/](http://www.microchip.com/). This website is used to make files and information easily available to customers. Some of the content available includes:

- **Product Support** – Data sheets and errata, application notes and sample programs, design resources, user's guides and hardware support documents, latest software releases and archived software
- **General Technical Support** – Frequently Asked Questions (FAQs), technical support requests, online discussion groups, Microchip design partner program member listing
- **Business of Microchip** – Product selector and ordering guides, latest Microchip press releases, listing of seminars and events, listings of Microchip sales offices, distributors and factory representatives

---

## Product Change Notification Service

---

Microchip's product change notification service helps keep customers current on Microchip products. Subscribers will receive email notification whenever there are changes, updates, revisions or errata related to a specified product family or development tool of interest.

To register, go to [www.microchip.com/pcn](http://www.microchip.com/pcn) and follow the registration instructions.

---

## Customer Support

---

Users of Microchip products can receive assistance through several channels:

- Distributor or Representative
- Local Sales Office
- Embedded Solutions Engineer (ESE)
- Technical Support

Customers should contact their distributor, representative or ESE for support. Local sales offices are also available to help customers. A listing of sales offices and locations is included in this document.

Technical support is available through the website at: [www.microchip.com/support](http://www.microchip.com/support)

---

## Microchip Devices Code Protection Feature

---

Note the following details of the code protection feature on Microchip devices:

- Microchip products meet the specifications contained in their particular Microchip Data Sheet.
- Microchip believes that its family of products is secure when used in the intended manner and under normal conditions.
- There are dishonest and possibly illegal methods being used in attempts to breach the code protection features of the Microchip devices. We believe that these methods require using the Microchip products in a manner outside the operating specifications contained in Microchip's Data Sheets. Attempts to breach these code protection features, most likely, cannot be accomplished without violating Microchip's intellectual property rights.
- Microchip is willing to work with any customer who is concerned about the integrity of its code.
- Neither Microchip nor any other semiconductor manufacturer can guarantee the security of its code. Code protection does not mean that we are guaranteeing the product is "unbreakable." Code protection is constantly evolving. We at Microchip are committed to continuously improving the code protection features of our products. Attempts to break Microchip's code protection feature may be a violation of the Digital Millennium Copyright Act. If such acts allow unauthorized access to your software or other copyrighted work, you may have a right to sue for relief under that Act.

## Legal Notice

---

Information contained in this publication is provided for the sole purpose of designing with and using Microchip products. Information regarding device applications and the like is provided only for your convenience and may be superseded by updates. It is your responsibility to ensure that your application meets with your specifications.

THIS INFORMATION IS PROVIDED BY MICROCHIP "AS IS". MICROCHIP MAKES NO REPRESENTATIONS OR WARRANTIES OF ANY KIND WHETHER EXPRESS OR IMPLIED, WRITTEN OR ORAL, STATUTORY OR OTHERWISE, RELATED TO THE INFORMATION INCLUDING BUT NOT LIMITED TO ANY IMPLIED WARRANTIES OF NON-INFRINGEMENT, MERCHANTABILITY, AND FITNESS FOR A PARTICULAR PURPOSE OR WARRANTIES RELATED TO ITS CONDITION, QUALITY, OR PERFORMANCE.

IN NO EVENT WILL MICROCHIP BE LIABLE FOR ANY INDIRECT, SPECIAL, PUNITIVE, INCIDENTAL OR CONSEQUENTIAL LOSS, DAMAGE, COST OR EXPENSE OF ANY KIND WHATSOEVER RELATED TO THE INFORMATION OR ITS USE, HOWEVER CAUSED, EVEN IF MICROCHIP HAS BEEN ADVISED OF THE POSSIBILITY OR THE DAMAGES ARE FORESEEABLE. TO THE FULLEST EXTENT ALLOWED BY LAW, MICROCHIP'S TOTAL LIABILITY ON ALL CLAIMS IN ANY WAY RELATED TO THE INFORMATION OR ITS USE WILL NOT EXCEED THE AMOUNT OF FEES, IF ANY, THAT YOU HAVE PAID DIRECTLY TO MICROCHIP FOR THE INFORMATION. Use of Microchip devices in life support and/or safety applications is entirely at the buyer's risk, and the buyer agrees to defend, indemnify and hold harmless Microchip from any and all damages, claims, suits, or expenses resulting from such use. No licenses are conveyed, implicitly or otherwise, under any Microchip intellectual property rights unless otherwise stated.

## Trademarks

---

The Microchip name and logo, the Microchip logo, Adaptec, AnyRate, AVR, AVR logo, AVR Freaks, BesTime, BitCloud, chipKIT, chipKIT logo, CryptoMemory, CryptoRF, dsPIC, FlashFlex, flexPWR, HELDO, IGLOO, JukeBlox, KeeLoq, Klear, LANCheck, LinkMD, maXStylus, maXTouch, MediaLB, megaAVR, Microsemi, Microsemi logo, MOST, MOST logo, MPLAB, OptoLyzer, PackeTime, PIC, picoPower, PICSTART, PIC32 logo, PolarFire, Prochip Designer, QTouch, SAM-BA, SenGenuity, SpyNIC, SST, SST Logo, SuperFlash, Symmetricom, SyncServer, Tachyon, TimeSource, tinyAVR, UNI/O, Vectron, and XMEGA are registered trademarks of Microchip Technology Incorporated in the U.S.A. and other countries.

AgileSwitch, APT, ClockWorks, The Embedded Control Solutions Company, EtherSynch, FlashTec, Hyper Speed Control, HyperLight Load, IntelliMOS, Libero, motorBench, mTouch, Powermite 3, Precision Edge, ProASIC, ProASIC Plus, ProASIC Plus logo, Quiet-Wire, SmartFusion, SyncWorld, Temux, TimeCesium, TimeHub, TimePictra, TimeProvider, WinPath, and ZL are registered trademarks of Microchip Technology Incorporated in the U.S.A.

Adjacent Key Suppression, AKS, Analog-for-the-Digital Age, Any Capacitor, AnyIn, AnyOut, Augmented Switching, BlueSky, BodyCom, CodeGuard, CryptoAuthentication, CryptoAutomotive, CryptoCompanion, CryptoController, dsPICDEM, dsPICDEM.net, Dynamic Average Matching, DAM, ECAN, Espresso T1S, EtherGREEN, IdealBridge, In-Circuit Serial Programming, ICSP, INICnet, Intelligent Paralleling, Inter-Chip Connectivity, JitterBlocker, maxCrypto, maxView, memBrain, Mindi, MiWi, MPASM, MPF, MPLAB Certified logo, MPLIB, MPLINK, MultiTRAK, NetDetach, Omniscient Code Generation, PICDEM, PICDEM.net, PICKit, PICtail, PowerSmart, PureSilicon, QMatrix, REAL ICE, Ripple Blocker, RTAX, RTG4, SAM-ICE, Serial Quad I/O, simpleMAP, SimpliPHY, SmartBuffer, SMART-I.S., storClad, SQL, SuperSwitcher, SuperSwitcher II, Switchtec, SynchroPHY, Total Endurance, TSHARC, USBCheck, VariSense, VectorBlox, VeriPHY, ViewSpan, WiperLock, XpressConnect, and ZENA are trademarks of Microchip Technology Incorporated in the U.S.A. and other countries.

SQTP is a service mark of Microchip Technology Incorporated in the U.S.A.

The Adaptec logo, Frequency on Demand, Silicon Storage Technology, and Symmcom are registered trademarks of Microchip Technology Inc. in other countries.

GestIC is a registered trademark of Microchip Technology Germany II GmbH & Co. KG, a subsidiary of Microchip Technology Inc., in other countries.

All other trademarks mentioned herein are property of their respective companies.

© 2022, Microchip Technology Incorporated, Printed in the U.S.A., All Rights Reserved.

ISBN: 978-1-6683-0841-7

## Quality Management System

---

For information regarding Microchip's Quality Management Systems, please visit [www.microchip.com/quality](http://www.microchip.com/quality).



## Worldwide Sales and Service

AMERICAS	ASIA/PACIFIC	ASIA/PACIFIC	EUROPE
<p><b>Corporate Office</b> 2355 West Chandler Blvd. Chandler, AZ 85224-6199 Tel: 480-792-7200 Tel: 480-792-7277 Technical Support: <a href="http://www.microchip.com/support">www.microchip.com/support</a> Web Address: <a href="http://www.microchip.com">www.microchip.com</a></p> <p><b>Atlanta</b> Duluth, GA Tel: 678-957-9614 Fax: 678-957-1455</p> <p><b>Austin, TX</b> Tel: 512-257-3370</p> <p><b>Boston</b> Westborough, MA Tel: 774-760-0087 Fax: 774-760-0088</p> <p><b>Chicago</b> Itasca, IL Tel: 630-285-0071 Fax: 630-285-0075</p> <p><b>Dallas</b> Addison, TX Tel: 972-818-7423 Fax: 972-818-2924</p> <p><b>Detroit</b> Novi, MI Tel: 248-848-4000</p> <p><b>Houston, TX</b> Tel: 281-894-5983</p> <p><b>Indianapolis</b> Noblesville, IN Tel: 317-773-8323 Fax: 317-773-5453 Tel: 317-536-2380</p> <p><b>Los Angeles</b> Mission Viejo, CA Tel: 949-462-9523 Fax: 949-462-9608 Tel: 951-273-7800</p> <p><b>Raleigh, NC</b> Tel: 919-844-7510</p> <p><b>New York, NY</b> Tel: 631-435-6000</p> <p><b>San Jose, CA</b> Tel: 408-735-9110 Tel: 408-436-4270</p> <p><b>Canada - Toronto</b> Tel: 905-695-1980 Fax: 905-695-2078</p>	<p><b>Australia - Sydney</b> Tel: 61-2-9868-6733</p> <p><b>China - Beijing</b> Tel: 86-10-8569-7000</p> <p><b>China - Chengdu</b> Tel: 86-28-8665-5511</p> <p><b>China - Chongqing</b> Tel: 86-23-8980-9588</p> <p><b>China - Dongguan</b> Tel: 86-769-8702-9880</p> <p><b>China - Guangzhou</b> Tel: 86-20-8755-8029</p> <p><b>China - Hangzhou</b> Tel: 86-571-8792-8115</p> <p><b>China - Hong Kong SAR</b> Tel: 852-2943-5100</p> <p><b>China - Nanjing</b> Tel: 86-25-8473-2460</p> <p><b>China - Qingdao</b> Tel: 86-532-8502-7355</p> <p><b>China - Shanghai</b> Tel: 86-21-3326-8000</p> <p><b>China - Shenyang</b> Tel: 86-24-2334-2829</p> <p><b>China - Shenzhen</b> Tel: 86-755-8864-2200</p> <p><b>China - Suzhou</b> Tel: 86-186-6233-1526</p> <p><b>China - Wuhan</b> Tel: 86-27-5980-5300</p> <p><b>China - Xian</b> Tel: 86-29-8833-7252</p> <p><b>China - Xiamen</b> Tel: 86-592-2388138</p> <p><b>China - Zhuhai</b> Tel: 86-756-3210040</p>	<p><b>India - Bangalore</b> Tel: 91-80-3090-4444</p> <p><b>India - New Delhi</b> Tel: 91-11-4160-8631</p> <p><b>India - Pune</b> Tel: 91-20-4121-0141</p> <p><b>Japan - Osaka</b> Tel: 81-6-6152-7160</p> <p><b>Japan - Tokyo</b> Tel: 81-3-6880-3770</p> <p><b>Korea - Daegu</b> Tel: 82-53-744-4301</p> <p><b>Korea - Seoul</b> Tel: 82-2-554-7200</p> <p><b>Malaysia - Kuala Lumpur</b> Tel: 60-3-7651-7906</p> <p><b>Malaysia - Penang</b> Tel: 60-4-227-8870</p> <p><b>Philippines - Manila</b> Tel: 63-2-634-9065</p> <p><b>Singapore</b> Tel: 65-6334-8870</p> <p><b>Taiwan - Hsin Chu</b> Tel: 886-3-577-8366</p> <p><b>Taiwan - Kaohsiung</b> Tel: 886-7-213-7830</p> <p><b>Taiwan - Taipei</b> Tel: 886-2-2508-8600</p> <p><b>Thailand - Bangkok</b> Tel: 66-2-694-1351</p> <p><b>Vietnam - Ho Chi Minh</b> Tel: 84-28-5448-2100</p>	<p><b>Austria - Wels</b> Tel: 43-7242-2244-39 Fax: 43-7242-2244-393</p> <p><b>Denmark - Copenhagen</b> Tel: 45-4485-5910 Fax: 45-4485-2829</p> <p><b>Finland - Espoo</b> Tel: 358-9-4520-820</p> <p><b>France - Paris</b> Tel: 33-1-69-53-63-20 Fax: 33-1-69-30-90-79</p> <p><b>Germany - Garching</b> Tel: 49-8931-9700</p> <p><b>Germany - Haan</b> Tel: 49-2129-3766400</p> <p><b>Germany - Heilbronn</b> Tel: 49-7131-72400</p> <p><b>Germany - Karlsruhe</b> Tel: 49-721-625370</p> <p><b>Germany - Munich</b> Tel: 49-89-627-144-0 Fax: 49-89-627-144-44</p> <p><b>Germany - Rosenheim</b> Tel: 49-8031-354-560</p> <p><b>Israel - Ra'anana</b> Tel: 972-9-744-7705</p> <p><b>Italy - Milan</b> Tel: 39-0331-742611 Fax: 39-0331-466781</p> <p><b>Italy - Padova</b> Tel: 39-049-7625286</p> <p><b>Netherlands - Drunen</b> Tel: 31-416-690399 Fax: 31-416-690340</p> <p><b>Norway - Trondheim</b> Tel: 47-72884388</p> <p><b>Poland - Warsaw</b> Tel: 48-22-3325737</p> <p><b>Romania - Bucharest</b> Tel: 40-21-407-87-50</p> <p><b>Spain - Madrid</b> Tel: 34-91-708-08-90 Fax: 34-91-708-08-91</p> <p><b>Sweden - Gothenberg</b> Tel: 46-31-704-60-40</p> <p><b>Sweden - Stockholm</b> Tel: 46-8-5090-4654</p> <p><b>UK - Wokingham</b> Tel: 44-118-921-5800 Fax: 44-118-921-5820</p>