

FR60 FAMILY ADAPTER BOARD EMA-MB91FV460B-001

USER GUIDE

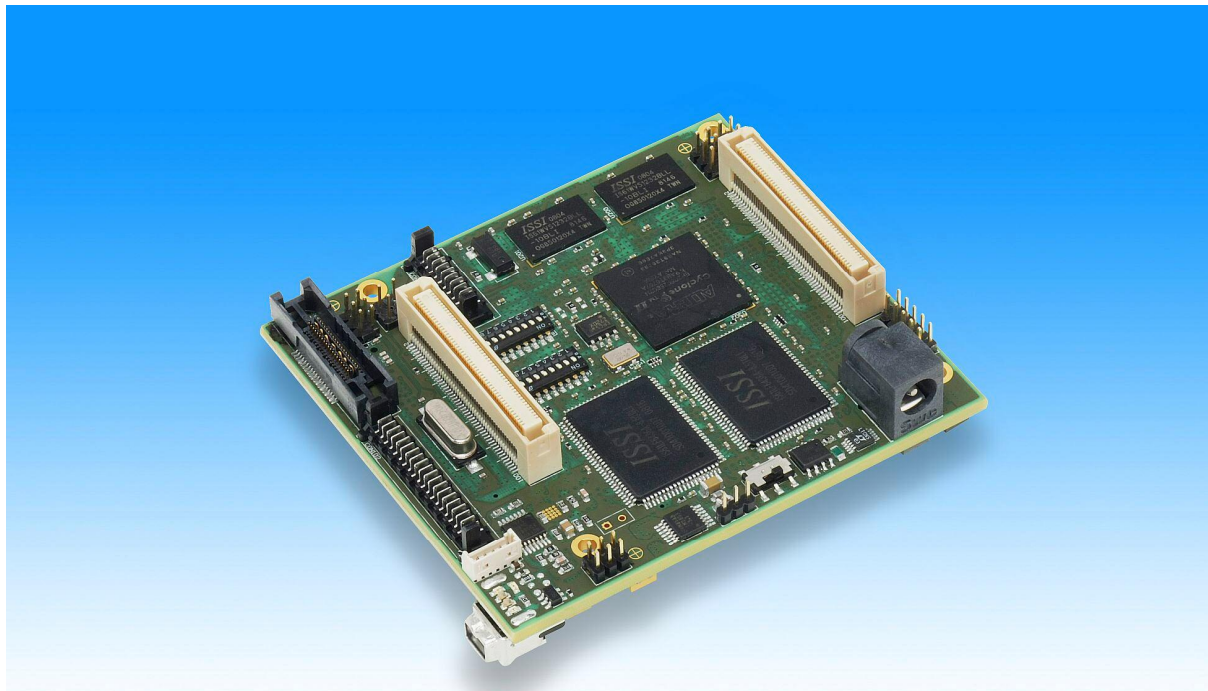

Revision History

Date	Issue
2008-11-14	V1.0 AW First draft
2009-01-14	V1.1 AW/CEy topICE settings added, defined “old”/“new” devices in Series Mode table, added information to APIX Interface chapter, corrected China RoHS, some minor improved descriptions
2009-03-13	V1.2 CEy Restructured whole document, added new chapters (e.g. Quick Start Overview), improved existing chapters and figures (e.g. jumper overview)
2009-04-07	V1.3 CEy Corrected memory map in chapter 5, changed wording of “old” and “new” in S100-2..4 description
2009-04-14	V1.4 CEy Added description of Boot Flash programming via Softune Workbench (chapter 6.1.1), improved description of Main Flash programming
2009-05-28	V1.5 CEy Updated disclaimer to new FME standard disclaimer, added troubleshooting chapter 8, corrected usable Emulation SRAM size

These were the latest revisions of related documents when this user guide revision had been released:

Schematic: 1.4
PCB: 1.3
FPGA: 1.1

This document contains 48 pages.

Warranty and Disclaimer

The use of **the deliverables** (e.g. software, application examples, target boards, evaluation boards, starter kits, engineering samples of IC's etc.) is subject to the conditions of Fujitsu Microelectronics Europe GmbH ("FME") as set out in (i) the terms of the License Agreement and/or the Sale and Purchase Agreement under which agreements the Product has been delivered, (ii) the technical descriptions and (iii) all accompanying written materials.

Please note that the deliverables are intended for and must only be used in an evaluation laboratory environment.

The software deliverables are provided without charge and therefore provided on an as-is basis. The software deliverables are to be used exclusively in connection with FME products.

Regarding hardware deliverables, FME warrants that they will be free from defects in material and workmanship under use and service as specified in the accompanying written materials for a duration of 1 year from the date of receipt by the customer.

Should a hardware deliverable turn out to be defect, FME's entire liability and the customer's exclusive remedy shall be, at FME's sole discretion, either return of the purchase price and the license fee, or replacement of the hardware deliverable or parts thereof, if the deliverable is returned to FME in original packing and without further defects resulting from the customer's use or the transport. However, this warranty is excluded if the defect has resulted from an accident not attributable to FME, or abuse or misapplication attributable to the customer or any other third party not relating to FME or to unauthorised decompiling and/or reverse engineering and/or disassembling.

FME does not warrant that the deliverables does not infringe any third party intellectual property right (IPR). In the event that the deliverables infringe a third party IPR it is the sole responsibility of the customer to obtain necessary licenses to continue the usage of the deliverable.

In the event the software deliverables include the use of open source components, the provisions of the governing open source license agreement shall apply with respect to such software deliverables.

To the maximum extent permitted by applicable law FME disclaims all other warranties, whether express or implied, in particular, but not limited to, warranties of merchantability and fitness for a particular purpose for which the deliverables are not designated.

To the maximum extent permitted by applicable law, FME's liability is restricted to intention and gross negligence. FME is not liable for consequential damages.

Should one of the above stipulations be or become invalid and/or unenforceable, the remaining stipulations shall stay in full effect

Contents

REVISION HISTORY	2
WARRANTY AND DISCLAIMER	3
CONTENTS	4
1 INTRODUCTION	6
1.1 Abstract.....	6
1.2 General Description.....	8
1.3 Features.....	9
1.4 Important precautions and hints	10
1.5 System Overview	11
2 INSTALLATION	13
2.1 Assembly.....	13
2.2 Power on / off sequence.....	14
2.3 Disassembly instructions	15
3 QUICK START OVERVIEW	17
4 OPERATION	18
4.1 Jumpers, Connectors, Switches and LEDs Overview	18
4.1.1 Jumper Overview.....	18
4.1.2 Connector Overview	18
4.1.3 Switches Overview	19
4.1.4 LED Overview.....	19
4.2 Location of Parts	20
4.3 Detailed Jumper, Connectors, Switches and LED Description.....	23
4.3.1 Power supply on / off (SW 400 / J408).....	23
4.3.2 Power supply jumper setting (J400).....	23
4.3.3 Power supply fault LED (D400).....	23
4.3.4 ADC reference voltage jumper setting (J401)	24
4.3.5 ADC supply jumper setting (J402)	24
4.3.6 Crystal Select (J100)	24
4.3.7 FPGA mode control (S100-1).....	25
4.3.8 FPGA mode [2..0] (S100-2..4)	25
4.3.9 SER mode [2..0] (S100-2..4).....	26
4.3.10 HWWDG_KILL (S100-8).....	27
4.3.11 FIX_EN# (S101-1).....	27

4.3.12	SRAM_SF# (S101-2).....	27
4.3.13	CSV_KILL (S101-3).....	27
4.3.14	FSC_DISABLE (S101-4).....	28
4.3.15	EDSU_BREAK# (S101-5).....	28
4.3.16	FPGA control [0..2] (S101-6..8).....	28
4.3.17	FPGA ready LED (D303).....	29
4.3.18	Reset (INITx) LED (D302).....	29
4.3.19	LED D301.....	29
4.3.20	LED D300.....	29
4.3.21	APIX Interface (CON100).....	30
4.3.22	Programming Adapter (J101, J102, CON101).....	31
5	EXTERNAL EMULATION SRAM / INTERNAL FLASH MEMORY	33
6	PROGRAMMING	34
6.1	Programming the BootFlash.....	34
6.1.1	Via Softune Workbench.....	34
6.1.2	Via FME FR Programmer.....	35
6.2	Programming the (main) Flash memory.....	37
7	PRECAUTIONS WHEN USING SOCKET ADAPTER BOARDS	38
7.1	Using EMA-MB91F460x-xxxMxx.....	38
7.2	Common precautions for NLS and LS boards.....	38
7.3	Using EMA-MB91F46xx-NLS-xxxMxx.....	39
7.4	Using EMA-MB91F46xx-LS-xxxMxx.....	40
8	TROUBLESHOOTING	41
9	MECHANICAL DIMENSIONS.....	42
10	PCB HISTORY.....	43
10.1	EMA-MB91FV460B-001 PCB Rev. 1.3.....	43
11	FPGA HISTORY	44
11.1	EMA-MB91FV460B-001 FPGA Rev. 1.0.....	44
11.2	EMA-MB91FV460B-001 FPGA Rev. 1.1.....	44
12	INFORMATION IN THE WWW.....	45
13	CHINA-ROHS REGULATION	46
14	RECYCLING	48

1 Introduction

1.1 Abstract

The EMA-MB91FV460B-001 is an adapter board for the Fujitsu MB91460 Series microcontroller.

The board can be equipped with different socket adapter boards to replace different MB91460 family based microcontrollers. The board allows the designer immediately to start with the software development before the appropriate silicon samples are available.

**This board must only be used for test applications
in an evaluation laboratory environment.**

Before using the EMA-MB91FV460B-001 adapter board, make sure that the following packed components have been delivered:

- 1 pcs. EMA-MB91FV460B-001 board (1)
- 1 pcs. Programming adapter (2) + 2 x screws
- 1 pcs. AC adapter 5V / > 1500mA (3)
- 1 pcs. Adapter cable for MB2198-10 in-circuit emulator (4)
- 1 pcs. User Guide
- 1 pcs. Micros DVD
- 1 pcs. EMA Disassembly Kit, consisting of
 - 1 x Screwdriver Torx TX8 (A)
 - 1 x Spanner M5 (B)
 - 5 x Screws DIN 7985 A2 M2,5X30 TX8, 1 spare (C)
 - 5 x Bolts M2,5 X 8, 1 spare (D)
 - 5 x Sockets, 1 spare (E)

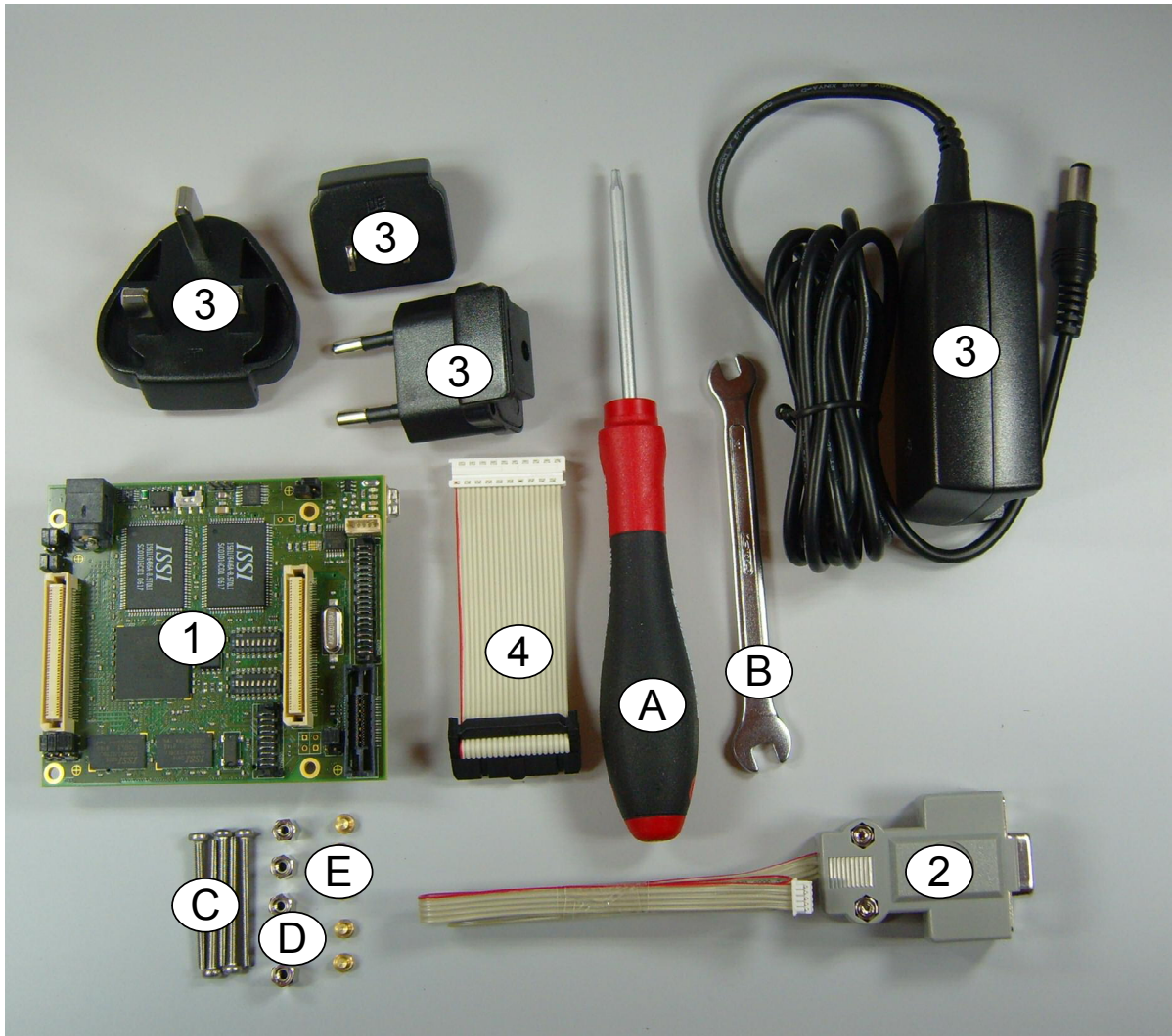

Figure 1-1: System components overview

1.2 General Description

The EMA-MB91FV460B-001 in combination with a socket adapter board replaces a MB91460 family based microcontroller. An Emulation SRAM (512k x 64 Bit) is connected to the F-Bus memory resources.

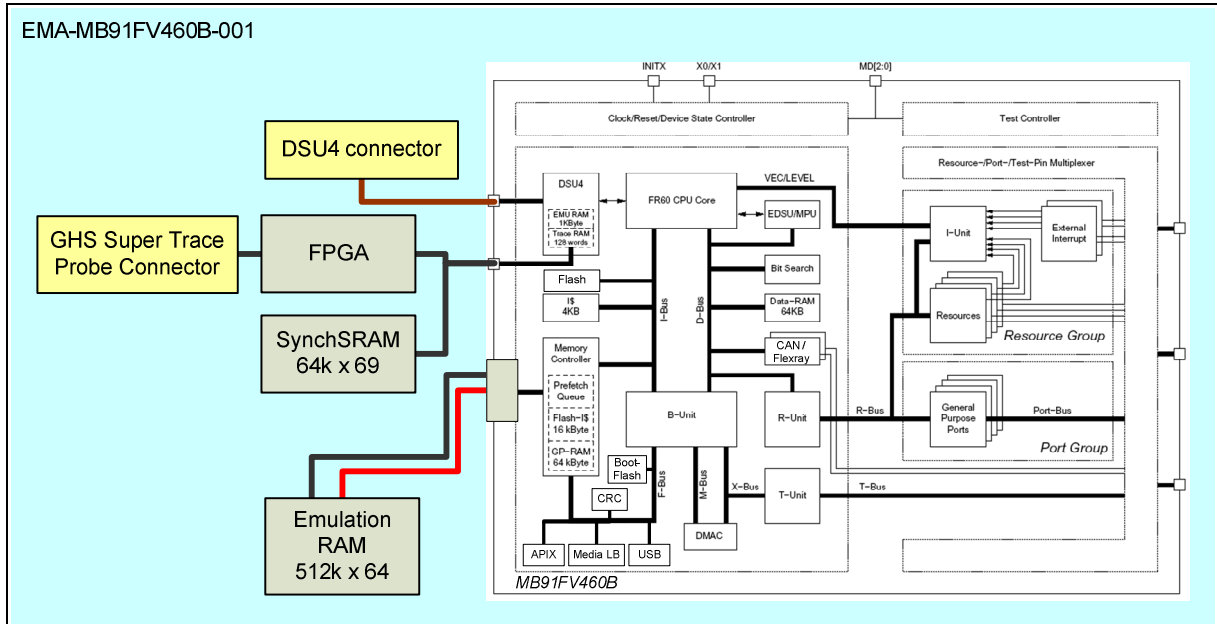

Figure 1-2: EMA-MB91FV460B-001 overview

The board is supplied with a 4MHz crystal as the main oscillation clock. Using the internal PLL of the MCU, internal clock rates up to 100MHz (see datasheet) can be achieved. Alternatively a crystal on the target board can be connected to the MB91FV460B oscillator (J100).

Additionally a 32kHz crystal is mounted for use as a sub clock.

A programming adapter can be connected to the EMA-MB91FV460B-001 board.

The operating mode of the microcontroller (MD0, MD1, MD2) and the reset signal (INITX) can be controlled by the target board or by the EMA-MB91FV460B-001 board.

1.3 Features

The following points describe some of the features of the EMA-MB91FV460B-001 with evaluation chip MB91FV460B. Especially the differences to the old EMA-MB91V460A-002B/-80/-003 with evaluation chip MB91V460A are pointed out.

- The MB91FV460B has 2112 kB of internal Flash memory. Furthermore, there are 4 MB SRAM mounted on EMA-MB91FV460B-001 for use as external emulation memory (only 2112KB usable). The user can switch between Flash memory and Emulation SRAM. The sectors can be configured via register ROMS to match the size and location of the MB91460 Series MCU for which the user is developing.
- The MB91FV460B now has split power domains VDD5 and VDD35 that can be independently set to 5 V or 3.3 V on EMA-MB91FV460B-001. This means that socket adapter boards with level-shifters are not longer required!
- MB91FV460B supports a maximum core frequency of 100 MHz
- MB91FV460B is equipped with 16 KB BootFlash memory. This BootFlash memory allows the user to program the BootROM code that is used by the MB91460 Series MCU for which the user is developing. To change the BootROM code in the BootFlash memory a special procedure must be executed that is described in chapter 6.1
- MB91FV460B covers the whole functionality of at least all currently (January 2009) available MB91460 Series MCU, including e.g. APIX, FlexRay and MediaLB. Therefore, extensions boards such as EMA-MB91V460A-100 (FlexRay) and EMA-MB91V460A-300 (APIX) are not longer required.
- There are several MB91460 Series MCU with a special port multiplexing functionality (e.g. MB91460P) or a non-standard port layout (e.g. MB91460Q). All these modes are now supported by MB91FV460B and can be set with switches on EMA-MB91FV460B-001.
- EMA-MB91FV460B-001 combines the trace features of the former EMA-MB91V460A-002B/-80 and EMA-MB91V460A-003. This means there is an on-board trace memory for 64 k frames. Alternatively you can connect the SuperTraceProbe from GreenHills Software Inc. to gather trace data.

1.4 Important precautions and hints

Please check the following points before using EMA-MB91FV460B-001:

- Follow the instructions in chapter 2.1/2.3 when mounting/dismounting the EMA-MB91FV460B-001 to/from socket adapter boards.
- Only use the delivered power supply unit! EMA-MB91FV460B-001 is directly supplied with 5V from the external power supply unit. When using other power supply units with different output voltages, a red warning LED will light. Protective measures are implemented on EMA-MB91FV460B-001 to prevent damage in such cases.
- **Remove or attach the cable between EMA-MB91FV460B-001 and DSU MB2198-10 only when power of both systems is off.**
- Check the jumper settings for VDD5 and VDD35 and compare them with the target board settings before switching power on. You can probably use the settings in the Quick Start Overview (chapter 3) as a basic configuration.
- Follow the power off/on sequence described in chapter 2.2
- When using socket adapter boards, especially those of (old) type EMA-MB91F46x-NLS-xxxMxx or EMA-MB91F46x-LS-xxxMxx, please refer to chapter 7 for a description of the necessary settings
- When using EMA-MB91FV460B-001 in stand-alone operation (without socket adapters and target board connected refer to the Quick Start Overview (chapter 3) for the necessary settings

1.5 System Overview

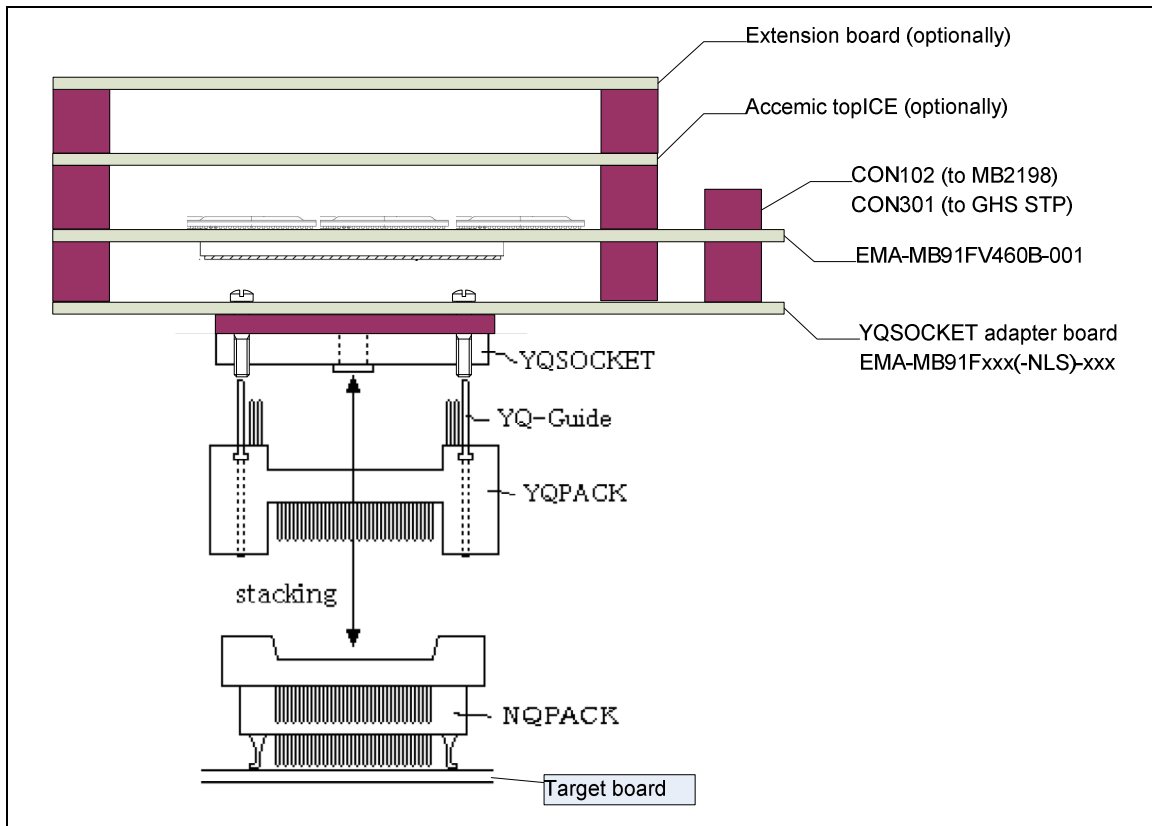

Figure 1-3: System overview

The EMA-MB91FV460B-001 can be used in combination with the following emulation devices:

- Fujitsu MB2198 emulator system (MB2198-01 with MB2198-10)
- GHS Super Trace Probe emulator (also a Fujitsu MB2198 emulator system is required)
- Accemic topICE emulator

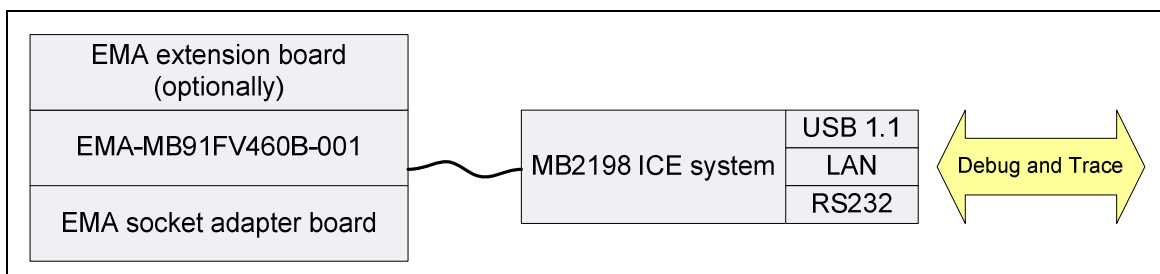

Figure 1-4: Configuration 1: EMA-MB91FV460B-001 and Fujitsu MB2198 in-circuit-emulator system

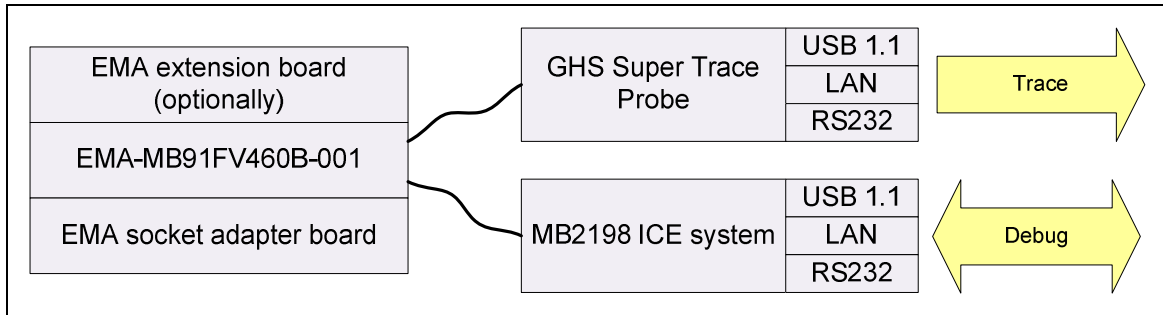

Figure 1-5: Configuration 2: EMA-MB91FV460B-001 and GHS Super Trace Probe / Fujitsu MB2198 in-circuit-emulator system

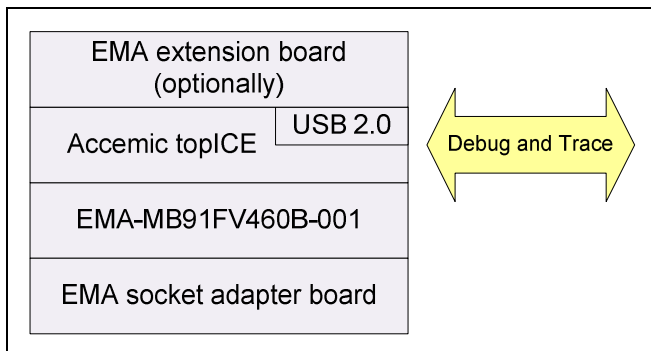

Figure 1-6: Configuration 3: EMA-MB91FV460B-001 and Accemic topICE in-circuit-emulator system

2 Installation

2.1 Assembly

Remove carefully the EMA-MB91FV460B-001 board from the shipping carton and check if there are any damages.

Install the socket adapter board, as described in the specific socket adapter board manual. Please check very carefully the exact adjustment.

Switch off the power supply of the target board, the EMA-MB91FV460B-001 and other connected devices.

Optionally, fix the EMA-MB91FV460B-001 adapter board by using M2.5 screws and M2.5 fibre washers.

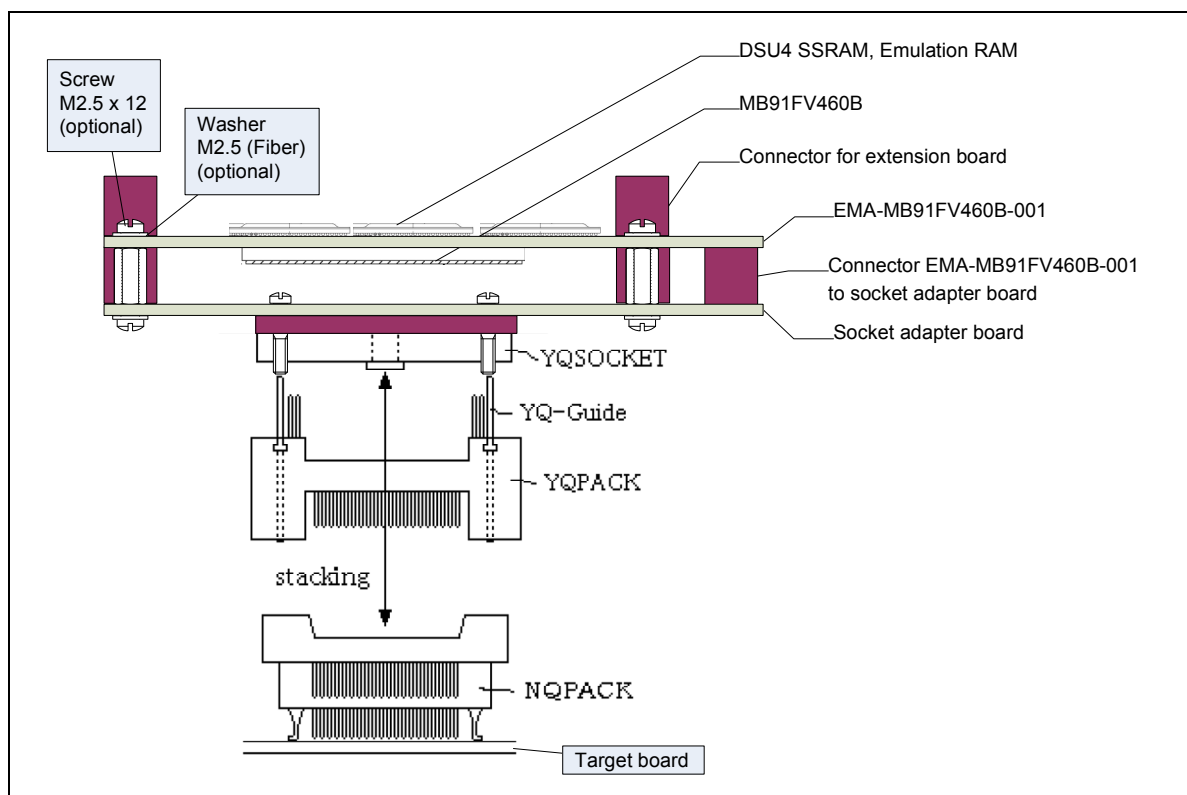

Figure 2-1: EMA-MB91FV460B-001 system installation

2.2 Power on / off sequence

After power-on of the EMA-MB91FV460B-001 board, the blue power-on LED (D303) should be on. If the LED is off, turn off the power supply and check the default jumper and switch settings.

If the red over-voltage / over-current warning LED (D400) is on or blinking, either the input voltage is higher than 5.25V or the current consumption is too high.

Please remove or attach the cable between EMA-MB91FV460B-001 and MB2198-10 only when power of both systems is off.

EMA-MB91FV460B-001 / MB2198-01 power on sequence

1. Turn MB2198-01 power on.
2. Turn EMA-MB91FV460B-001 power on.
3. Turn target board power on (if connected)

EMA-MB91FV460B-001 / MB2198-01 power off sequence

1. Turn target board power off (if connected).
2. Turn EMA-MB91FV460B-001 power off.
3. Turn MB2198 power off

2.3 Disassembly instructions

Because the connectors can be damaged by awkwardly disassembling, it is strongly recommended to use the enclosed disassembly components and strictly follow the described disassembly instructions.

***Strictly follow the described disassembly instructions.
Otherwise, the board connectors may be damaged.***

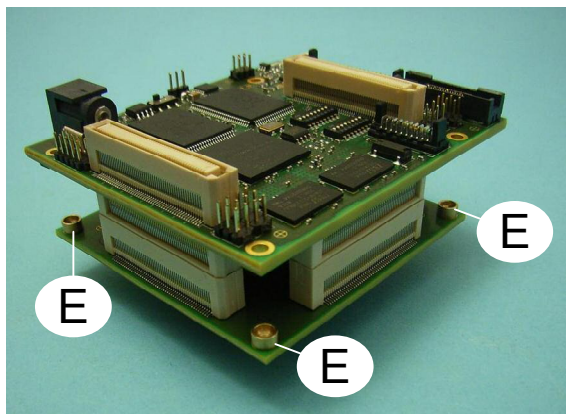

I.) Put sockets in holes of EMA socket adapter board. (only 3 visible in picture)

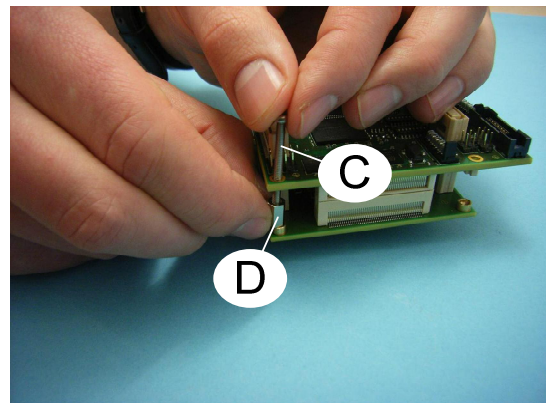

II.) Lay a bolt on top of one socket. Turn a screw with one hand and hold the bolt with the other hand. Turn so far that the bolt touches the upper EMA board.

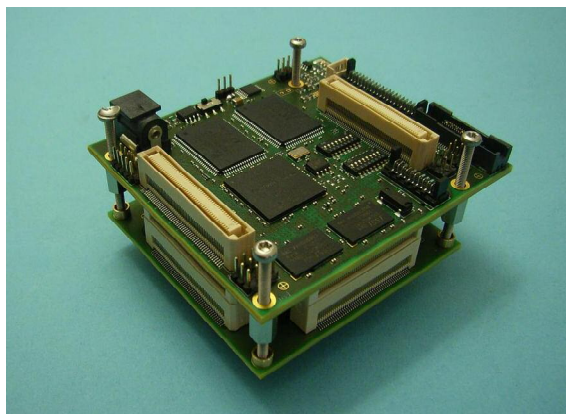

III.) After you have executed steps II and III four times. The situation should be similar to the one in the picture above

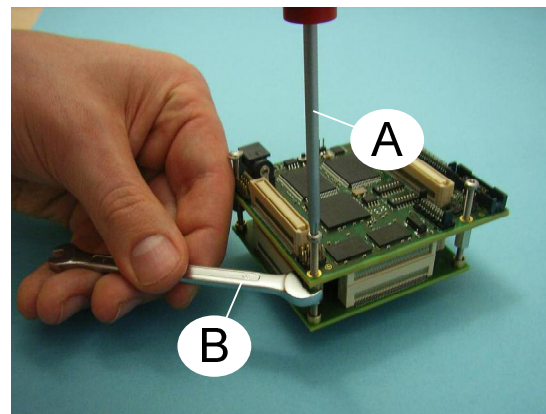

IV.) Hold the bolts with the spanner (or your fingers if possible) and ...

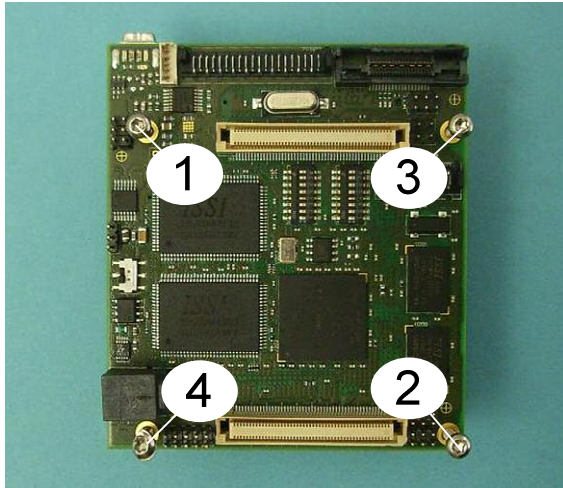

V.) ...turn the screws clockwise in small steps in the following sequence: 1-2-3-4-1-2-3-4-1-... and so on until you can easily dismount the upper EMA board

Caution:
Lift the sides equally! Avoid canting!

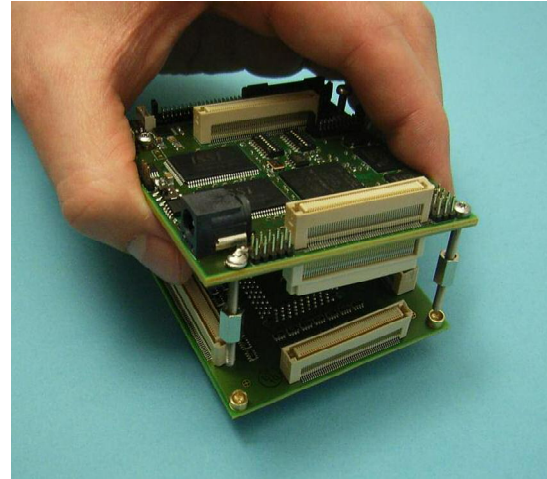

VI.) Finished!

Table 2-1: Disassembly process

3 Quick Start Overview

The following overview table contains settings that will most likely allow you to use EMA-MB91FV460B-001 without having to read the whole User Guide in detail. The settings apply to the most common use cases. For the location and numbering of the jumpers and switches see chapter 4.2

Item	Ref. ¹	Operation Modes			
		Standalone	EMA-MB91F460x-xxxMxx ^{2,3}	EMA-MB91F46xx-NLS-xxxMxx ^{2,3}	EMA-MB91F46xx-LS-xxxMxx ^{2,3}
S100-1 FPGA_MD_CTRL	4.3.7	ON	OFF (Mode pins MD[2:0] taken from target board)		
S100-[2:4] FPGA_MD_[2:0]	4.3.8	OFF, OFF, OFF	don't care		
S100-[5:7] SER_MD_[2:0]	4.3.9	Series Mode: Dependent on the device to be emulated			
S100-8 HWWDG_KILL	4.3.10	ON ⁴			
S101-1 FIX_EN#	4.3.11	ON			
S101-2 SRAM_SF#	4.3.12, 5, 6.2	OFF			
S101-3 CSV_KILL	4.3.13	ON			
S101-4 FSC_DISABLE	4.3.14	OFF			
S101-5 EDSU_BREAK#	4.3.15	OFF			
S101-[6:8] FPGA_CTRL[0:2]	4.3.16	OFF, OFF, OFF			
J400-2,4,6 VDD5	4.3.2, 7	don't care	Match target board VDD5 setting!		
J400-1,3,5 VDD35	4.3.2, 7	don't care	Match target board VDD35 setting!	Match VDD5 setting!	
J401-1,3,5 AVRH0	4.3.4, 7	Close 3,5 (AVRH0 = VDD5)	Close 1,3 (AVRH0 = AVRH(0) target board)		
J401-2,4,6 AVRH1	4.3.4, 7	Match AVRH0 setting (see above)!		Close 4,6 (AVRH1 = VDD5)	
J402-1,3,5 AVCC0	4.3.5, 7	Close 3,5 (AVCC0 = VDD5)	Close 1,3 (AVCC0 = AVCC(0) target board)		
J402-2,4,6 AVCC1	4.3.5, 7	Match AVCC0 setting (see above)!		Close 4,6 (AVCC1 = VDD5)	
J100-1,3,5 / 2,4,6 X0 / X1	4.3.6	Close 3,5 and 4,6 (on-board 4MHz crystal)			
J101-1,2,3,4,5 SIN select	4.3.22	Close 1,2 and 4,5 (no SIN signal is routed to programming connector)			
J102-1,2,3,4,5 SOT select	4.3.22	Close 1,2 and 4,5 (no SOT signal is routed to programming connector)			

¹ For more information refer to the listed chapters

² It is assumed that also a target board is connected

³ Please refer to chapter 7 for further advices when using socket adapter boards

⁴ OFF for EMA-MB91FV460B-001 prototypes with MB91FV460B1 with HW Watchdog Bug when not using workarounds

4 Operation

4.1 Jumpers, Connectors, Switches and LEDs Overview

This chapter describes all jumpers, connectors and switches that can be modified or accessed on the EMA-MB91FV460B-001 adapter board.

4.1.1 Jumper Overview

Jumper	Description / Function	Type	Default
J100	Crystal select	Jumper 3x2 pol	3-5, 4-6
J101	Programming Connector SIN	Jumper 5 pol	1-2, 4-5
J102	Programming Connector SOT	Jumper 5 pol	1-2, 4-5
J400	VDD35 / VDD5	Jumper 3x2 pol	3-5, 2-4
J401	AVRH 0/1	Jumper 3x2 pol	1-3, 2-4
J402	AVCC 0/1	Jumper 3x2 pol	1-3, 2-4
J300	Additional INITx input (not assembled)	Jumper 2 pol	---
J408	Additional Power ON/OFF input (not assembled)	Jumper 2 pol	---
J606	5V supply for Accemic topICE	Jumper 3 pol	open

4.1.2 Connector Overview

Connector	Description / Function	Type	Default
CON100	APIX interface	Molex 540300471	APIX cable
CON101	Flash programming interface	Molex 530470510	Programming cable
CON102	MB2198 interface	Molex 903259020	MB2198-10 cable
CON300	FPGA programming cable	Molex 903259010	Altera USB Blaster (via adapter cable)
CON301	GHS STP connector	Mictor 2-767004-2	GHS STP cable
CON400	5V power supply	Switchcraft RAPC 722	Power supply 5V

4.1.3 Switches Overview

Switch	Signal	Description / Function	Default
S100-1	FPGA_MD_CTRL	MD[2..0] control source	OFF
S100-2	FPGA_MD_2	MD[2..0] control (S100-1 must be ON for getting FPGA_MD_[2:0] effective)	OFF
S100-3	FPGA_MD_1		OFF
S100-4	FPGA_MD_0		OFF
S100-5	SER_MD_2		SER_MD_[2..0] control
S100-6	SER_MD_1	OFF	
S100-7	SER_MD_0	OFF	
S100-8	HWWDG_KILL	Hardware Watchdog	ON
S101-1	FIX_EN#	Fixed Mode / Reset Vector	ON
S101-2	SRAM_SF#	Emulation SRAM / Internal Flash	OFF
S101-3	CSV_KILL	Clock Supervisor	ON
S101-4	FSC_DISABLE	Flash Security	OFF
S101-5	EDSU_BREAK#	Embedded Debug Support Unit Break	OFF
S101-6	FPGA_CTRL0	Reserved for future use	OFF
S101-7	FPGA_CTRL1		OFF
S101-8	FPGA_CTRL2		OFF
SW 400		Power on / off	ON

Note: "ON"/"OFF" does not necessarily indicate the logic level of the related signal. Please refer to the detailed description of each switch.

4.1.4 LED Overview

LED	Colour	Signal	Description / Function	Default
D400	Red	U402_FAULT	Overvoltage / overcurrent warning	OFF
D303	Blue	LED0	Operation ok	ON
D302	Yellow	LED1	Reset active	OFF
D301	Yellow	LED2	Reserved	OFF
D300	Red	LED3	Reserved	OFF

Do not stare into LEDs or view directly with optical instruments.

4.2 Location of Parts

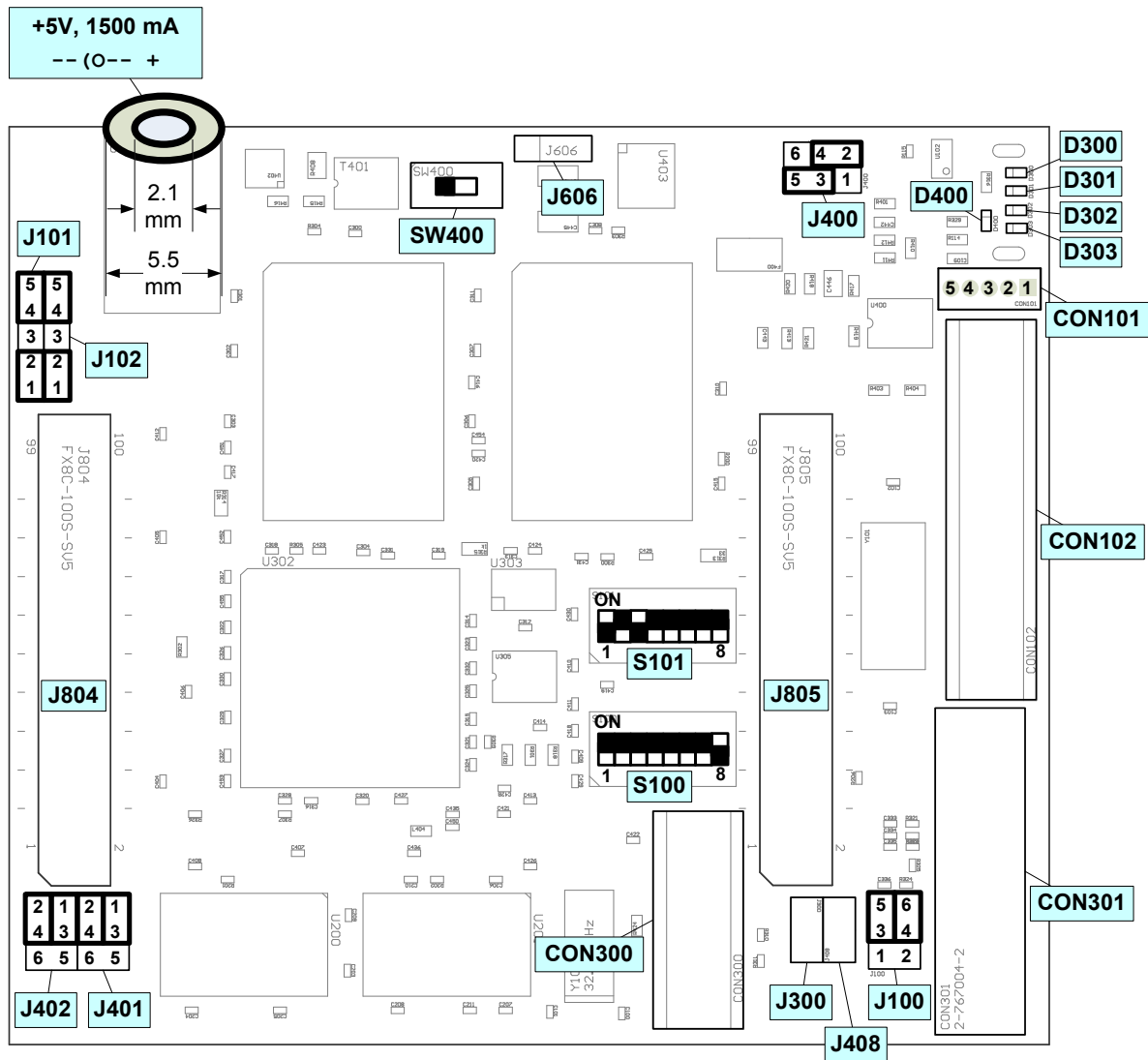

Figure 4-1: Location of parts and default settings (top layer)

J804, J805 are connectors for extension boards on the top (e.g. Accemic topICE)

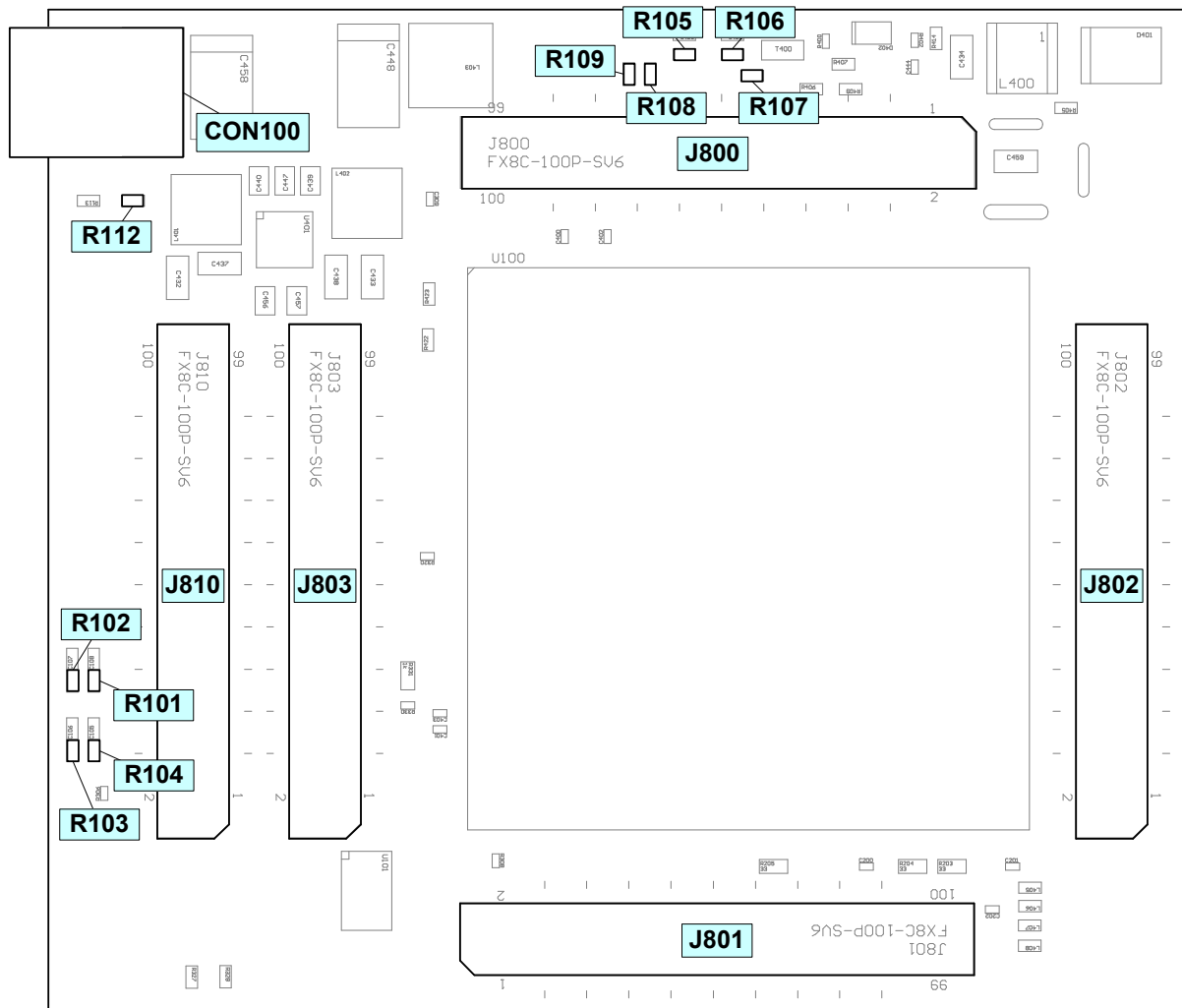

Figure 4-2: Location of parts (bottom layer)

J800, J801, J802, J803, J810 are connectors for socket adapter boards or special extension boards

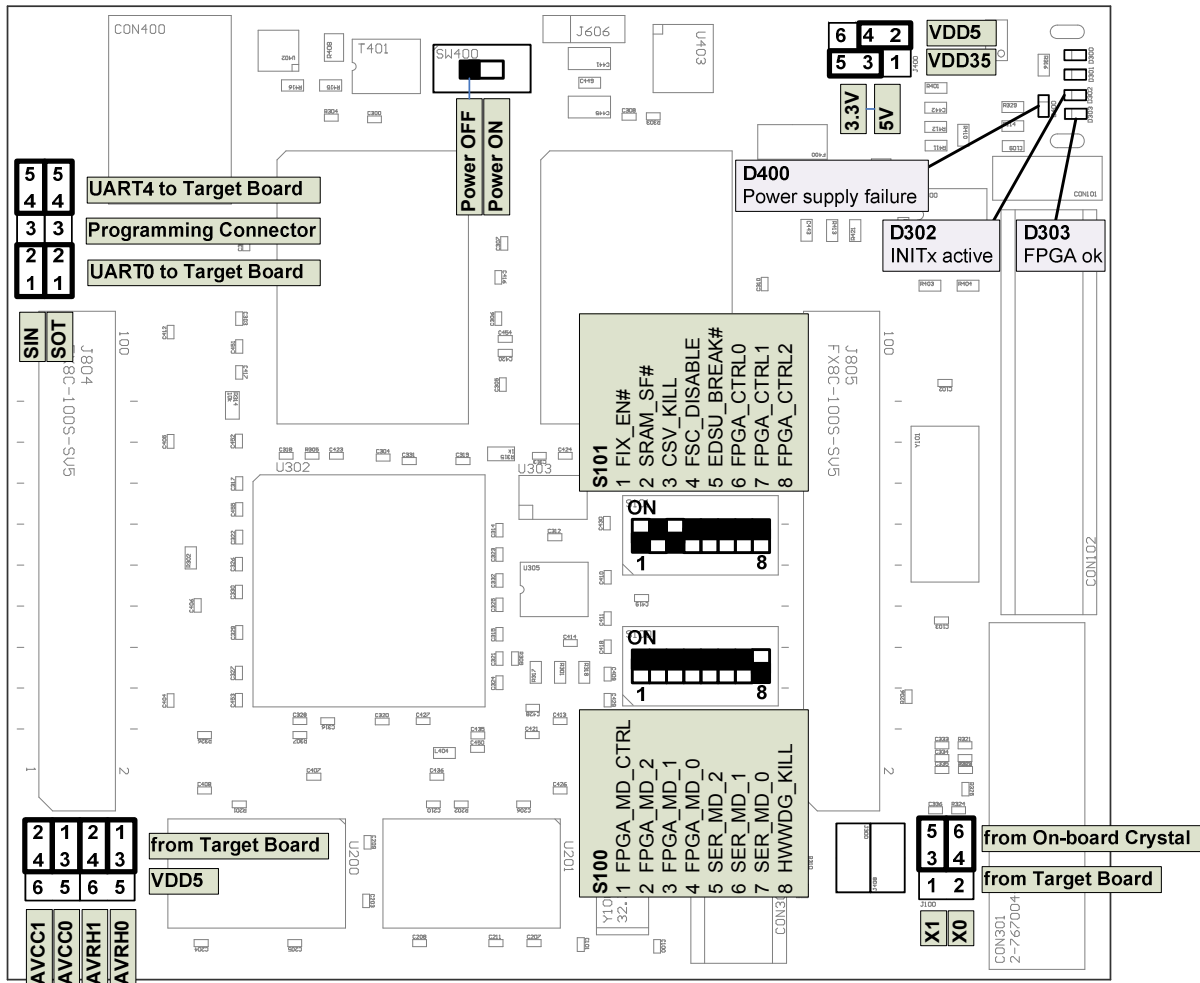

Figure 4-3: Jumpers, switches and LEDs overview

4.3 Detailed Jumper, Connectors, Switches and LED Description

The default setting is shown with a grey shaded area.

4.3.1 Power supply on / off (SW 400 / J408)

SW400: power supply on

J408 (not assembled) is a bypass for SW400.

Switch	State	Description
SW400	ON	Power supply on
	OFF	Power supply off

Default: SW400: ON, J408: open (not assembled)

4.3.2 Power supply jumper setting (J400)

J400: defines the voltage of VDD5 and VDD35

Jumper	Setting	Description
J400 1,3,5 (VDD35)	1-3	VDD35 is connected to 5V. Be sure that the target board accepts 5V signals on the pins of the VDD35 domain!
	3-5	VDD35 is connected to 3.3V With this setting the target board is not allowed to supply 5V level signals to the EMA-MB91FV460B-001 board on the pins of the VDD35 domain!
J400 2,4,6 (VDD5)	2-4	VDD5 is connected to 5V Be sure that the target board accepts 5V signals on the pins of the VDD5 domain!
	4-6	VDD5 is connected to 3.3V With this setting the target board is not allowed to supply 5V level signals to the EMA-MB91FV460B-001 board on the pins of the VDD5 domain!

Default: J400 3-5, 2-4

4.3.3 Power supply fault LED (D400)

D400: U402_FAULT output

LED	State	Description
D400	ON (red)	Input voltage > 5.25V or current consumption too high
	OFF	Supply voltage ok

Default: D400: OFF

4.3.4 ADC reference voltage jumper setting (J401)

J401: defines the AVRH0 / AVRH1 source

Jumper	Setting	Description
J401 1,3,5 (AVRH 0)	1-3	AVRH0 is connected to AVRH0_T (target board).
	3-5	AVRH0 is connected to VDD5
J401 2,4,6 (AVRH 1)	2-4	AVRH1 is connected to AVRH1_T (target board)
	4-6	AVRH1 is connected to VDD5

Default: J401 1-3, 2-4

MB91FV460B includes 2 ADC with separate analogue high reference inputs.

4.3.5 ADC supply jumper setting (J402)

J402: defines the AVCC0 / AVCC1 source

Jumper	Setting	Description
J402 1,3,5 (AVCC 0)	1-3	AVCC0 is connected to AVCC0_T (target board)
	3-5	AVCC0 is connected to VDD5
J402 2,4,6 (AVCC 1)	2-4	AVCC1 is connected to AVCC1_T (target board)
	4-6	AVCC1 is connected to VDD5

Default: J402 1-3, 2-4

MB91FV460B includes 2 ADC with separate analogue supply inputs.

4.3.6 Crystal Select (J100)

J100: defines the X0 / X1 source

Jumper	Setting	Description
J100 2,4,6 (X0)	2-4	X0 of MB91FV460B is connected to the socket adapter board (J801-55)
	4-6	X0 of MB91FV460B is connected to the onboard 4MHz crystal (Y101)
J100 1,3,5 (X1)	1-3	X1 of MB91FV460B is connected to the socket adapter board (J801-54)
	3-5	X1 of MB91FV460B is connected to the onboard 4MHz crystal (Y101)

Default: J100 3-5, 4-6

4.3.7 FPGA mode control (S100-1)

Switch	Setting	Description
S100-1 (FPGA_MD_CTRL)	OFF (VDD5)	MD[2:0] pins are controlled by the target board.
	ON (GND)	MD[2:0] pins are controlled by the FPGA according to the S100-2..4 (FPGA_MD_[2:0]) setting.

Default: S100-1: OFF

You can either configure the MD[2:0] pins of MB91FV460B by on-board DIP switches S100-2..4 (necessary for stand-alone operation) or you can derive them from a connected target board.

4.3.8 FPGA mode [2..0] (S100-2..4)

The MD[2:0] pins are controlled by the FPGA when S100-1 is ON.

Switch	Setting			MD [2:0]	Description
	S100-2	S100-3	S100-4		
S100-2..4 (FPGA_MD_[2:0])	OFF	OFF	OFF	0 0 0	Internal ROM mode
	OFF	OFF	ON	0 0 1	External ROM mode
	OFF	ON	OFF	0 1 0	Reserved
	OFF	ON	ON	0 1 1	Reserved
	ON	OFF	OFF	1 0 0	Fallback BootROM
	ON	OFF	ON	1 0 1	Reserved
	ON	ON	OFF	1 1 0	Reserved
	ON	ON	ON	1 1 1	Reserved

Default: S100-2..4: OFF OFF OFF

(Note, the level of FPGA_MD_[2:0] will be inverted by the FPGA, so that "OFF" equals "0".)

4.3.9 SER mode [2..0] (S100-2..4)

Switch	Setting			SER_MD [2:0]	Description
	S100-5	S100-6	S100-7		
S100-5.7 (SER_MD_[2:0])	OFF	OFF	OFF	0 0 0	External bus is enabled after INIT (PFR,EPFR=1). Default mode for emulation of the following MCUs: MB91F464A, MB91F465K, MB91F465C/467C, MB91F465D/467D, MB91F469G
	OFF	OFF	ON	0 0 1	Enable pin multiplexing for MB91460P and T series, external bus is disabled after INIT in internal vector fetch mode (MD=000)
	OFF	ON	OFF	0 1 0	MB91461 mode, supports special clock features of MB91461, but does not support the separated power domains of MB91461 IO ring
	OFF	ON	ON	0 1 1	Enable pin multiplexing for MB91460B series, emulates the "no external bus" mode (MD3=0), for "external bus mode" (MD3=1) use SER_MD=000
	ON	OFF	OFF	1 0 0	Interrupt relocation for MB91460M series
	ON	OFF	ON	1 0 1	Interrupt relocation for MB91460Q series, external bus is disabled after INIT in internal vector fetch mode (MD=000)
	ON	ON	OFF	1 1 0	Reserved
	ON	ON	ON	1 1 1	External bus is disabled after INIT (PFR,EPFR=0) in internal vector fetch mode (MD=000). Default mode for emulation of all other MCUs not mentioned elsewhere in this table.

Default: S100-5..7: OFF OFF OFF

4.3.10 HWWDG_KILL (S100-8)

Switch	Setting	Description
S100-8 (HWWDG_KILL)	ON (GND)	Hardware-Watchdog is enabled
	OFF (VDD5)	Hardware-Watchdog is disabled

Default: S100-8: ON

The Hardware-Watchdog of MB91FV460B can be permanently disabled when setting this switch to OFF

4.3.11 FIX_EN# (S101-1)

Switch	Setting	Description
S101-1 (FIX_EN#)	ON (GND)	Fixed Mode / Reset Vector is enabled
	OFF (VDD5)	Fixed Mode / Reset Vector is disabled

Default: ON

When Fixed Mode / Reset Vector is enabled, the mode vector at address 0x000f:fff8 and the reset vector at address 0x000f:ffc cannot be changed and always return fixed values.

4.3.12 SRAM_SF# (S101-2)

Switch	Setting	Description
S101-2 (SRAM_SF#)	ON (GND)	Internal Flash Mode
	OFF (VDD5)	External Emulation SRAM Mode

Default: OFF

With this switch you can define whether the internal Flash memory or the external Emulation SRAM is connected to the F-Bus and acts as program memory.

4.3.13 CSV_KILL (S101-3)

Switch	Setting	Description
S101-3 (CSV_KILL)	ON (GND)	Clock supervisor is enabled
	OFF (VDD5)	Clock supervisor is disabled

Default: ON

The clock supervisor function can be deactivated permanently by setting this switch to OFF.

4.3.14 FSC_DISABLE (S101-4)

Switch	Setting	Description
S101-4 (FSC_DISABLE)	ON (GND)	Enable flash security
	OFF (VDD5)	Disable flash security

Default: OFF

If Flash security is disabled by this switch, the internal Flash security vector fetch is skipped. and also CRC calculation will not be possible.

4.3.15 EDSU_BREAK# (S101-5)

Switch	Setting	Description
S101-5 (EDSU_BREAK#)	ON (GND)	Embedded Debug Support Unit Break is active
	OFF (VDD5)	Embedded Debug Support Unit Break is not active

Default: OFF

This signal is connected to bit INTO of BSTAT register in the Embedded Debug Support Unit (EDSU). It can be used to generate a "Tool NMI" (Non-Maskable Interrupt).

4.3.16 FPGA control [0..2] (S101-6..8)

Switch	Setting			Description
	S101-6	S101-7	S101-8	
S101-6.8 (FPGA_CTRL)	OFF	OFF	OFF	Normal function
	OFF	OFF	ON	Reserved
	OFF	ON	OFF	Reserved
	OFF	ON	ON	Reserved
	ON	OFF	OFF	Reserved
	ON	OFF	ON	Reserved
	ON	ON	OFF	Reserved
	ON	ON	ON	Reserved

Default: S101-6..8: OFF OFF OFF

4.3.17 FPGA ready LED (D303)

D303: FPGA is successfully configured

LED	State	Description
D303	ON (blue)	FPGA is successfully configured
	OFF	No power supply or FPGA programming fault

Default: D303: ON

4.3.18 Reset (INITx) LED (D302)

D302: INITx signal active

The INITx will be set low when one of the following signals gets active:

- INITx_EMA (J300 closed)
- INITx_MB2198 (INITx signal from MB2198 emulator)
- INITx_T (INITx signal from target board)
- INITx_BL (INITx signal from programming adapter)
- PWR_OK[1] (U402_EN output)

LED	State	Description
D302	ON (yellow)	FPGA sets INITx of MB91FV460B active (low)
	OFF	INITx is inactive (high)

Default: D302: OFF

4.3.19 LED D301

LED	State	Description
D301	ON	Reserved
	OFF	Reserved

Default: D301: OFF

4.3.20 LED D300

LED	State	Description
D300	ON	Reserved
	OFF	Reserved

Default: D300: OFF

4.3.21 APIX Interface (CON100)

CON100 type: Molex 540300471 (IEEE1394a)

An appropriate cable (IEEE1394a ↔ RJ45) for the connection to e.g. Indigo (MB88F332) evaluation board is included in EMA-MB91F460S-176M07 socket adapter board. It has the following signal assignment:

MB91FV460B Signal	CON 100 pin	CON 100 pin name	RJ45 pin
SDINM	1	TPB-	5
SDINP	2	TPB+	4
SDOUTM	3	TPA-	2
SDOUTP	4	TPA+	1

The APIX signals can also be routed to the bottom side connectors, so that the signals are available on EMA-MB91F460S-176M07 socket adapter board or EMA-MB91460-EVA-BOB. Please refer to the User Guide of EMA-MB91F460S-176M07 for the required steps.

4.3.22 Programming Adapter (J101, J102, CON101)

Accessing the UART0 and UART4 that are for example used for BootROM communication is possible via an external programming adapter or via the target board.

Jumper	Setting	Description
J101 (SIN)	1-2	SIN0 is connected to socket adapter board
	2-3	SIN0 is connected to programming adapter
	3-4	SIN4 is connected to programming adapter
	4-5	SIN4 is connected to socket adapter board

Default: J101 1-2 and 4-5

Jumper	Setting	Description
J102 (SOT)	1-2	SOT0 is connected to socket adapter board
	2-3	SOT0 is connected to programming adapter
	3-4	SOT4 is connected to programming adapter
	4-5	SOT4 is connected to socket adapter board

Default: J102 1-2 and 4-5

CON101 Programming adapter

The EMA-MB91FV460B-001 adapter board is shipped with a programming adapter, which can be plugged into CON101. The programming adapter can be powered with 3.3V or 5V and controls the INITX (reset) signal via the RTS line.

Please note, the RTS signal of the serial interface of PCs is per default on a positive voltage level, so that the EMA-MB91FV460B-001 will be most likely forced to stay in the reset state.

When using the FME FR Programmer the RTS line will be set appropriately when a connection attempt is made.

When using the programming adapter as a “normal” UART interface together with a terminal program, make sure, that the status and control signals of the RS232 interface can be set by the terminal program.

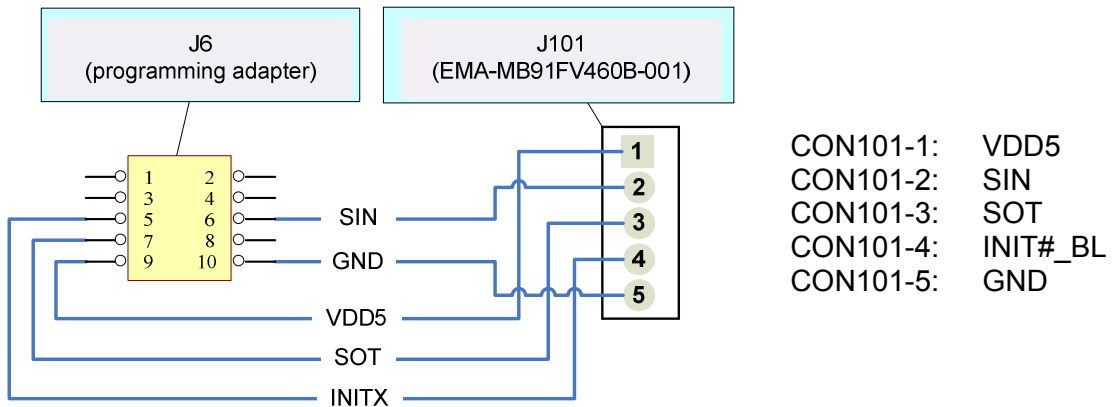

Figure 4-4: Connection programming adapter - EMA-MB91FV460B-001 adapter board

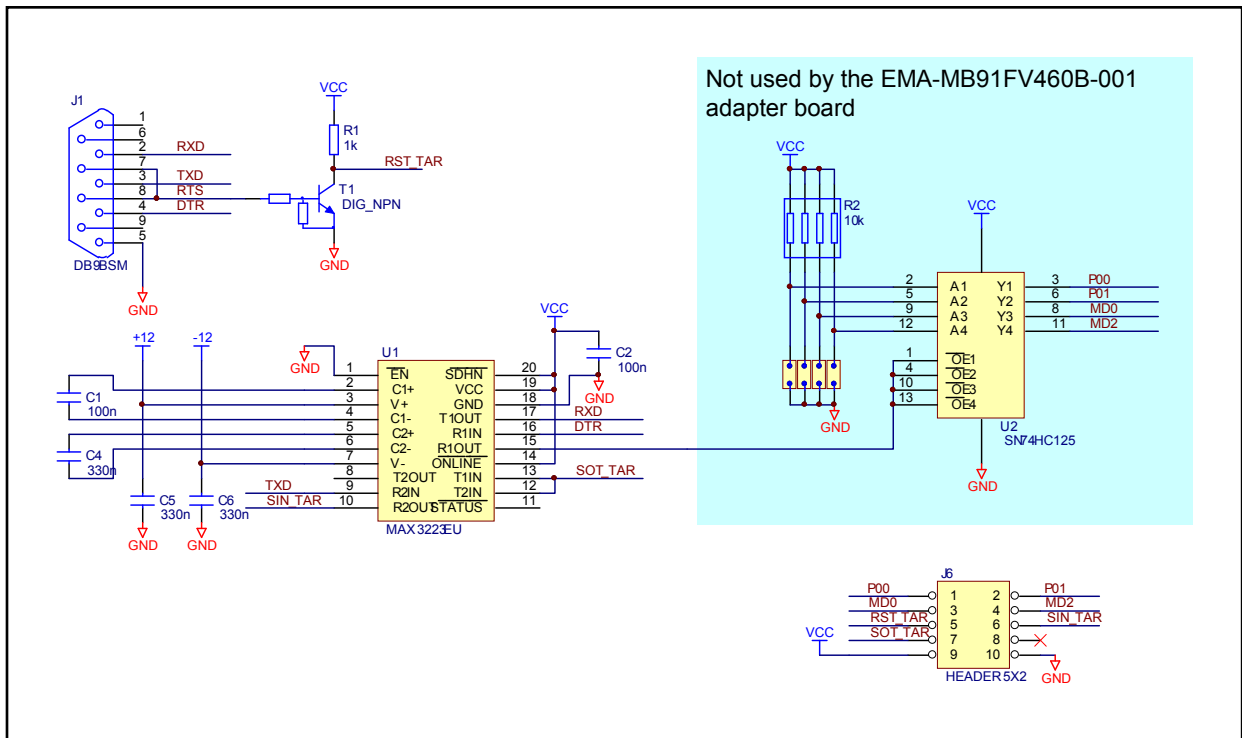

Figure 4-5: Schematic of the programming adapter

5 External Emulation SRAM / Internal Flash memory

The ROMS register defines if a particular address area is used as memory or external bus area. The SRAM_SF# signal defines if Emulation SRAM or internal Flash is used.

In that way you can configure the available memory space to match the final device.

After Power On reset, ROMS[0:10] bits are set, so that the whole internal Flash memory is available.

ROMS[x]	Start address	End address	Sectors	External Emulation SRAM, 2112 KB available	Internal 2112 KB Flash of MB91FV460B
0	0x04:0000	0x05:FFFF	8, 9		
1	0x06:0000	0x07:FFFF	10, 11		
2	0x08:0000	0x09:FFFF	12, 13		
3	0x0A:0000	0x0B:FFFF	14, 15		
4	0x0C:0000	0x0D:FFFF	16, 17		
5	0x0E:0000	0x0F:FFFF	18, 19		
6	0x10:0000	0x13:FFFF	20, 21, 22, 23		
7	0x14:0000	0x17:FFFF	24, 25, 26, 27		
8	0x18:0000	0x1B:FFFF	28, 29, 30, 31		
9	0x1C:0000	0x1F:FFFF	32, 33, 34, 35		
10	0x20:0000	0x24:FFFF (Flash / SRAM) 0x27:FFFF	0, 1, 2, 3, 4, 5, 6, 7, 36, 37, 38, 39		
11	0x28:0000	0x2F:FFFF	---		
12	0x30:0000	0x37:FFFF	---		
13	0x38:0000	0x3F:FFFF	---		
14	0x40:0000	0x47:FFFF	---		
15	0x48:0000	0x4F:FFFF	---		

Table 5-1: Memory mapping

Please also refer to the MB91FV460B data sheet for further details (e.g. sector sizes and addresses).

6 Programming

6.1 Programming the BootFlash

The MB91FV460B comes with a BootFlash memory that can be programmed with the BootROM code of the emulated MB91460 Series member, so that no differences in regard to the flash MCU exist in this area.

It is necessary to have a valid BootROM code programmed to the BootFlash memory. Otherwise your application will not run, because there is no branch to the start address of your application which would have been initiated by the BootROM code. (Though, you can manually patch the program counter register in Softune Workbench when you have started the debug session.)

Please contact microcontroller_info@fme.fujitsu.com for BootROM files!

6.1.1 Via Softune Workbench

For this method a special Softune Workbench project is provided that contains the BootFlash programming routines and a Softune Workbench procedure file that controls the whole programming process.

Following items are required:

- Softune Workbench Project “BootFlash_Auto_Programming” (incl. “PROGRAM_BOOTFLASH.prc” procedure file), available on the web
- BootROM binary image file of desired MB91460 Series MCU

Please obey the following steps for a successful programming:

- a) Power down MB2198-01, EMA-MB91FV460B-001 and connected target boards (if any) and afterwards power on again. Take care of power off/on sequences
- b) Ensure that the BootROM image file of the desired MB91460 Series MCU (e.g. MB91F465P.bin) is available in the “BootFlash_Auto_Programming” folder, otherwise put it there.
- c) Open the procedure file PROGRAM_BOOTFLASH.prc in a text editor. The file can also be found in the “BootFlash_Auto_Programming” folder. Search for the section labeled with START OF USER SETTINGS. Ensure that only one of the lines describing the appropriate BootROM file name is uncommented. Finally, save your changes and close the file.

```
#####
##### START OF USER SETTINGS #####
#####
# Uncomment the line below that matches the
# BootROM binary image file name by removing the '#'

[...]

#SET VARIABLE BOOTROM_FILENAME = MB91F467D.bin
SET VARIABLE BOOTROM_FILENAME = MB91F465P.bin
#SET VARIABLE BOOTROM_FILENAME = MB91F469Q.bin

[...]

#####
##### END OF USER SETTINGS #####
#####
```

- d) Open the workspace file "BootFlash_Auto_Programming.wsp" in Softune Workbench
- e) Now you can begin the automatic programming process by starting a debug session with your preferred connection method (USB, LAN, RS232). Maybe changes are necessary when choosing RS232 connection method, e.g. COM port number.
- f) No more interaction is required because the program flow is controlled by the procedure file. You can observe the programming process in the "Command" window of Softune Workbench. When it has ended please check the output messages for any errors. If the output looks as follows, the programming was successful:

```
-- START --

Loading BootRom data to RAM...Finished.
Starting programming software...
Break at \finished(H'00060000) by hardware breakpoint

PROCEDURE FILE reports: Comparing and looking for any differences...
Not found

PROGRAM reports: SUCCESSFUL!

Please look above for any error messages:
- File open errors
- Data comparison result of PROCEDURE file
- Result of PROGRAM

If no errors occurred, the BootFlash programming was probably successful!

-- END --
```

6.1.2 Via FME FR Programmer

An additional fixed fallback MiniBootROM is integrated in the MB91FV460B that allows the user to program the BootFlash via UART4 interface. For this purpose the following instructions must be regarded:

- a) Power down all tools and disconnect the cable to MB2198-10. Use the EMA-MB91FV460B-001 in stand-alone operation without any target board. Take care of power off sequence!
- b) Ensure the jumper settings according to Figure 6-1. Differences to the default settings are:
 - S100-1: ON
 - S100-2: ON
 - J100: Pins 2,4,6 open
 - J101: 1-2, 3-4
 - J102: 1-2, 3-4
- c) Connect the EMA-MB91FV460B-001 with the programming adapter to a COM-Port of your PC
- d) Power on the EMA-MB91FV460B-001
- e) Provide a 4MHz square wave clock signal at the marked pin. "High" voltage must meet VDD5 setting (5V default)

- f) Start the FME FR Programmer, set the correct COM-Port, choose "EMAMB91FV460B" in the Device Type drop-down list, click "Browse" to select the BootROM file that shall be programmed and click on the button "Automatic Mode"
- g) The output area should notify you of the programming process and success.
- h) If the programming was successful you can restore all the changes you made to the board

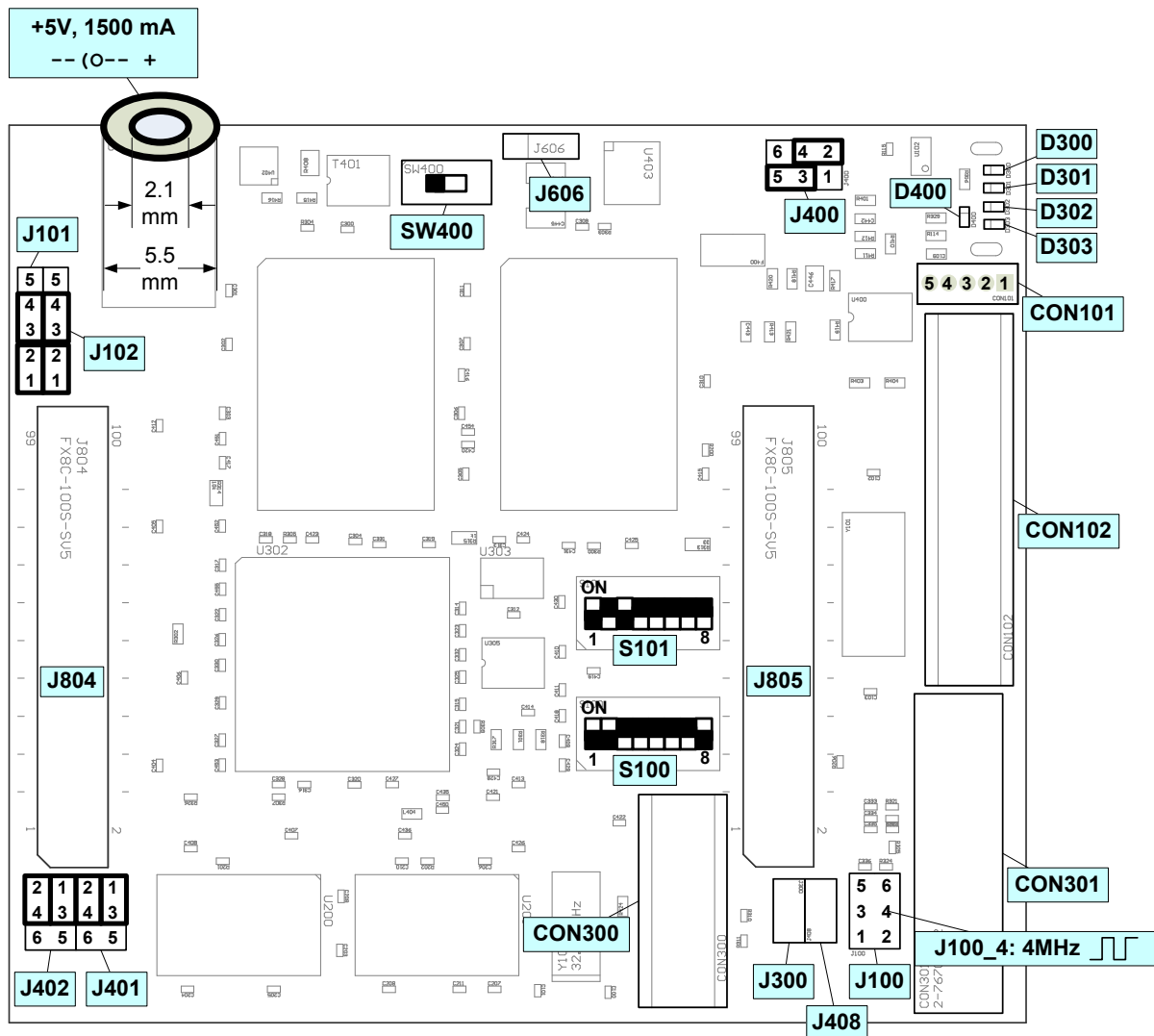

Figure 6-1: Settings for accessing the fallback MiniBootROM

6.2 Programming the (main) Flash memory

The MB91FV460B provides 2112KB of Flash memory that can be programmed with FME FR Programmer. To use the Flash memory instead of the external emulation SRAM on the EMA-MB91FV460B-001 the following instructions must be regarded.

- a) It is assumed that the BootFlash of MB91FV460B contains a valid BootROM code. For instructions on how to program the BootFlash please refer to chapter 6.1
- b) To switch from the emulation SRAM to the Flash memory set switch S101-2 (SRAM_SF#) to ON

S101-2 SRAM_SF#

Switch	Setting	Description
S101-2 (SRAM_SF#)	ON (GND)	Internal Flash Mode
	OFF (VDD5)	External Emulation SRAM Mode

Setting for flash memory programming: ON

- c) If you want to connect to the BootROM UART of MB91FV460B via an interface on your target board keep the default settings of J101 and J102. If the programming adapter should be used for the connection, J101 and J102 have to be set according to the actual programmed BootROM code.

Setting	J101	J102	Description
1	1-2, 4-5	1-2,4-5	Appropriate interface on target board is used
2	1-2, 3-4	1-2, 3-4	Programming adapter is used, BootROM of MB91460 Series MCU communicates over UART4
3	2-3, 4-5	2-3, 4-5	Programming adapter is used, BootROM of MB91460 Series MCU communicates over UART0

- d) Establish the connection to a COM-Port of your PC.
- e) Power on the EMA-MB91FV460B-001 and the target board (if any).

From this point on the programming process is comparable to that of an appropriate Flash microcontroller of the same MB91460 Series MCU

- f) Start the FME FR Programmer and set the correct COM-Port
- g) In the Device Type drop-down list choose the MB91460 Series MCU whose BootROM code was programmed to the BootFlash. (Do not select "EMAMB91FV460B, it is mainly used for BootFlash programming)
- h) Click "Browse" to select the .mhx file that shall be programmed.
- i) Click on the button "Automatic Mode" and reset the EMA-MB91FV460B-001 simultaneously. When using the programming adapter you can optionally configure the FME FR Programmer to conduct a reset automatically via the RTS signal. Go the "Signals" tab and set "RESET" to "RTS" and "active" to "low".
- j) The output area should notify you of the programming process and success.

7 Precautions when using Socket Adapter Boards

Currently there are 3 different types of socket adapter boards available:

1. **EMA-MB91F460x-xxxMxx** (e.g. EMA-MB91F460S-176M07):
These boards have been developed for EMA-MB91FV460B-001 and are recommended unrestrictedly.
2. **EMA-MB91F46xx-NLS-xxxMxx** (e.g. EMA-MB91F467D-NLS-208M04):
These boards have been developed for the former EMA-MB91V460A-002/B/-80 and are compatible to EMA-MB91FV460B-001.
Originally, NLS (“No Level-Shifter”) boards could only be used in system configurations where VDD35 was equal to VDD5.
Now they can be used without those restrictions, but certain precautions have to be regarded beforehand.
3. **EMA-MB91F46xx-LS-xxxMxx** (e.g. EMA-MB91F467D-LS-208M04):
These boards have been developed for the former EMA-MB91V460A-002/B/-80 and are compatible to EMA-MB91FV460B-001.
Originally, LS (“Level-Shifter”) boards were mainly used in system configurations where VDD35 was not equal to VDD5, but could also be used for equal VDD35 and VDD5. They have some restrictions related to port configuration possibilities.
Therefore, NLS boards had been recommended for use cases with equal VDD35 and VDD5 instead of LS boards.
Now they can still be used with those port restrictions, but certain precautions have to be regarded beforehand.

7.1 Using EMA-MB91F460x-xxxMxx

Part Name	Remarks / Precautions
EMA-MB91F460P-176M07	Make equal settings for AVRH0/AVRH1 (J401): Close EITHER 1,3 and 2,4 OR 3,5 and 4,6
EMA-MB91F460Q-320M06	
EMA-MB91F460S-176M07	Make equal settings for AVCC0/AVCC1 (J402): Close EITHER 1,3 and 2,4 OR 3,5 and 4,6
EMA-MB91F460X-100M20	

7.2 Common precautions for NLS and LS boards

- Set AVCC1 and AVRH1 to VDD5 via jumpers on the EMA-MB91FV460B-001.
- MB91FV460B has some additional resources (P36-P40) in comparison to MB91V460A, therefore these ports are not terminated on the old socket adapter boards and it is probably best to configure them as outputs or enable the internal pull-ups (e.g. via Softune Workbench procedure file, available on the web)
- Some of the old socket adapter boards supported port multiplexing/switching/relocating functionality via several jumpers. Set all these jumpers in such a way that the default pin assignment of the emulated MCU is established, because MB91FV460B can handle this functionality internally. Please refer to the User Guide of the used socket adapter board for further information about the jumper settings.

7.3 Using EMA-MB91F46xx-NLS-xxxMxx

In the following overview you will find some additional remarks and precautions about some NLS boards

Part Name	Remarks / Precautions
EMA-MB91F465P-NLS-176M07	<ul style="list-style-type: none"> P30, P32_3/7, P33_3/7, P34_3/7, P35_3/7 not routed to target <p>EMA-MB91F460P-176M07 should be used for full functionality!</p>
EMA-MB91F465X-NLS-100M20	<ul style="list-style-type: none"> P31_[0:2], P31_[4:6] not routed to target board FlexRay functionality would have to be emulated with EMA-MB91V460A-100 extension board although MB91FV460B has built-in FlexRay support! If EMA-MB91V460A-100 is used, set VDD35 to VDD5! <p>EMA-MB91F460X-100M20 should be used for full functionality</p>
EMA-MB91F467B-NLS144M08B	<ul style="list-style-type: none"> No further restriction for external bus mode (MD3 = 1) For Single Chip mode (MD3=0) please note that the MD3 pin of your target system is directly connected to VDD5 of your target system! This will be a problem as the MD3 pin in this mode is probably connected directly to GND on your target system <p>For Single Chip mode (MD3=0) EMA-MB91F467B-SC-144M08 should be used or take measures against the mentioned MD3/VDD5 connection (e.g. cut the MD3 connection to either GND or VDD5 on your target system or the socket adapter board while using the emulation system)</p>
EMA-MB91F467B-SC-144M08	<ul style="list-style-type: none"> Only for Single chip mode (MD3=0) Leave SER_MD setting in "Default" mode!
EMA-MB91F467C-NLS-144M08	<ul style="list-style-type: none"> Set VDD35 to the same level as VDD5 on EMA-MB91FV460B-001 because port P02 is supplied by VDD5 on MB91460C whereas it is supplied from the VDD35 domain on MB91FV460B

7.4 Using EMA-MB91F46xx-LS-xxxMxx

When using LS boards you also have to regard the following setting:

On EMA-MB91FV460B-001 set VDD35 to the same level as VDD5, otherwise due to CMOS logic the high level on I/Os of VDD35 domain would not be detected by the level-shifter. The output voltage of the IO pins of the VDD35 domain will be defined by the VDD35 setting of your target board. The figure below clarifies this setting:

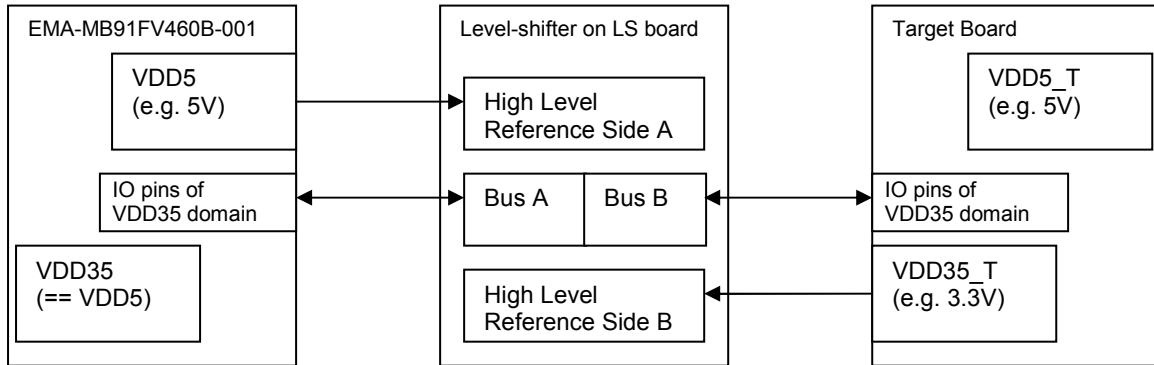

In the following overview you will find some additional remarks and precautions about some LS boards

Part Name	Remarks / Precautions
EMA-MB91F467B-LS144M08B	<ul style="list-style-type: none"> Only for external bus mode (MD3 = 1)
EMA-MB91F467S-LS-176M07	<ul style="list-style-type: none"> Routing of APIX SDINM/P and SDOUTM/P to target board not possible. On-board connector must be used. MCU pins 100-103 will be connected to 5V/1.8V. Check if this is a problem for the circuitry on the target board. Set jumpers J200-J205 to 2-3 on EMA-MB91F467S-LS-176M07! The related MCU pins would otherwise be connected to 2.5V/3.3V/1.2V/5V Set AVCC1 and AVRH1 on EMA-MB91FV460B-001 to VDD5 otherwise they are connected to VDD18_T (1.8V supply from target board) <p>Please refer to Application Note mcu-an-300100-e-vxx-ema_mb91f467s_ls_176-m07_with_ema_mb91fv460_001 for a more detailed description!</p> <p>EMA-MB91F460S-176M07 should be used for full functionality</p>

8 Troubleshooting

1a. The programming adapter is connected to the EMA-MB91FV460B-001 and I checked the jumper configuration and the settings in FME FR Programmer but whatever I do, it is not working.

1b. Sometimes the programming is not working, the FME FR Programmer can not establish a connection

Apply some pressure at the connector during the whole programming process. Try different directions. There might be a loose contact.

2. Sometimes when I try to stop a running program with the button in Softune Workbench there seems to be a time-out and Softune Workbench does not respond for a while.

If you are running on CLKB frequencies higher than 80MHz you could try the following:

Close Softune Workbench, then start the debug session again. Do not start the program but go to the following menu:

“Setup” – “Debug environment” – “Debug Environment...”:

Choose the “Frequency” tab and insert the value: D' 133

As a result this will decrease the debug interface clock frequency to achieve a more stable communication.

9 Mechanical dimensions

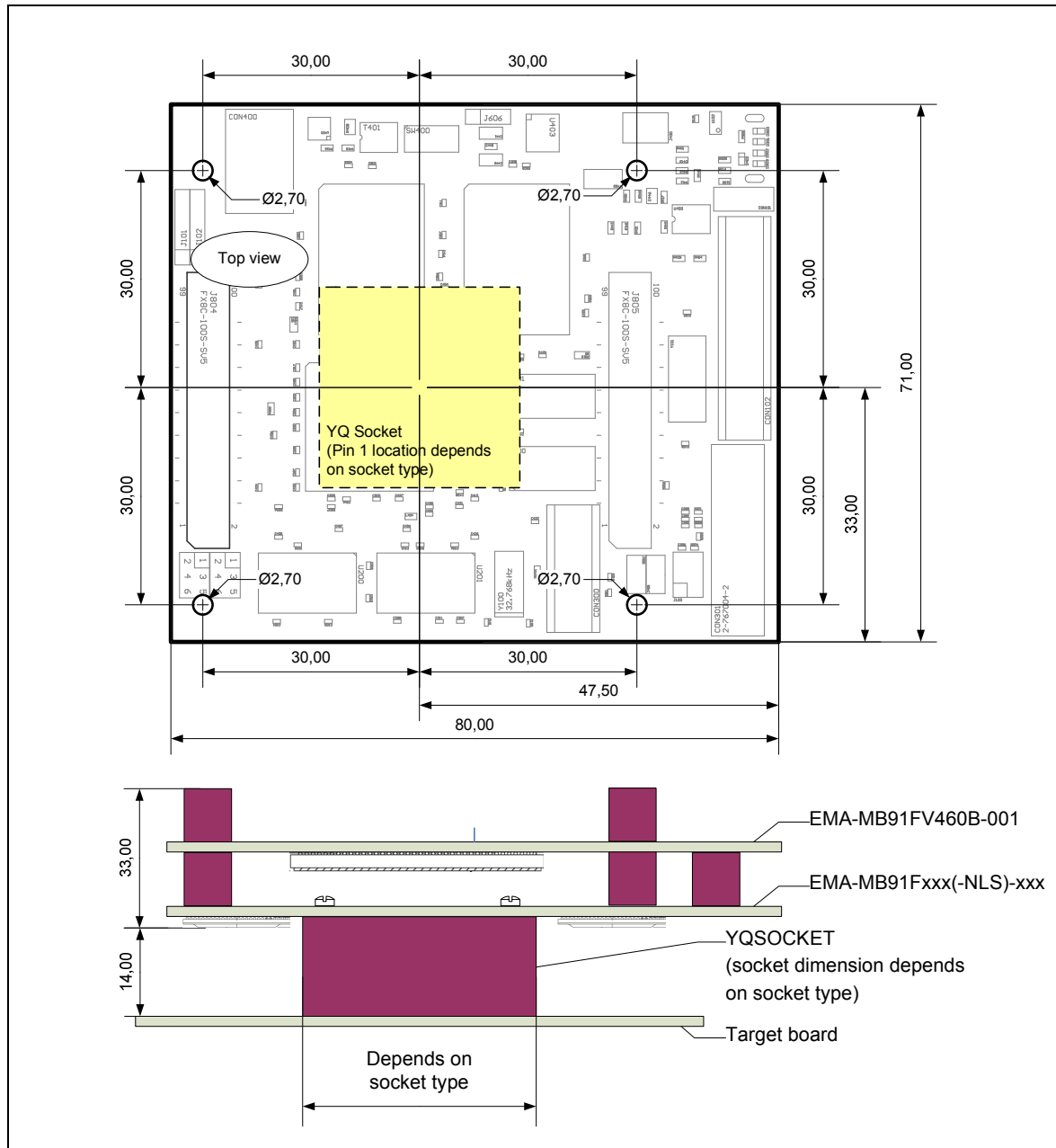

Figure 9-1: EMA-MB91FV460B-001 system mechanical dimensions

10 PCB History

10.1 EMA-MB91FV460B-001 PCB Rev. 1.3

Initial Version.

Known Limitations: Strictly take care for power-on/off sequence. No hot-plugging!

11 FPGA History

11.1 EMA-MB91FV460B-001 FPGA Rev. 1.0

Initial Version.

Known Limitations:

1. Reset behaviour
 - Conditions:
 - MB2198 emulator system is connected and used
 - Program is running (not in “break” state)
 - A reset occurs (external or via Softune Workbench command)
 - Problem description:
EMA-MB91FV460B-001 stays in a self-locked reset state if the conditions above apply. This problem is caused by a wrong implementation of the reset logic in the FPGA. Follow the power off sequence if the problem has occurred
 - Workaround:
None (make sure no reset is applied)

11.2 EMA-MB91FV460B-001 FPGA Rev. 1.1

Corrected reset behaviour.

12 Information in the WWW

Information about FUJITSU MICROELECTRONICS Products can be found on the following Internet pages:

Microcontrollers (8-, 16- and 32bit), Graphics Controllers
Datasheets and Hardware Manuals, Support Tools (Hard- and Software)

<http://mcu.emea.fujitsu.com/>

Power Management Products

<http://www.fujitsu.com/emea/services/microelectronics/powerman/>

Media Products: SAW filters, acoustic resonators and VCOs

<http://www.fujitsu.com/emea/services/microelectronics/saw/>

For more information about FUJITSU MICROELECTRONICS

<http://www.fujitsu.com/emea/services/microelectronics/>

13 China-RoHS regulation

Evaluation Board 评估板

Emulation Board 仿真板

根据SJ/T11364-2006

《电子信息产品污染控制标识要求》特提供如下有关污染控制方面的信息。

The following product pollution control information is provided according to SJ/T11364-2006 *Marking for Control of Pollution caused by Electronic Information Products*.

1. 电子信息产品污染控制标志说明 Explanation of Pollution Control Label



该标志表明本产品含有超过中国标准SJ/T11363-2006

《电子信息产品中有毒有害物质的限量要求》中限量的有毒有害物质。标志中的数字为本产品的环保使用期，表明本产品在正常使用的条件下，有毒有害物质不会发生外泄或突变，用户使用本产品不会对环境造成严重污染或对其人身、财产造成严重损害的期限，单位为年。

为保证所声明的环保使用期限，应按产品手册中所规定的环境条件和方法进行正常使用，并严格遵守产品维修手册中规定的定期维修和保养要求。

产品中的消耗件和某些零部件可能有其单独的环保使用期限标志，并且其环保使用期限有可能比整个产品本身的环保使用期限短。应到期按产品维修程序更换那些消耗件和零部件，以保证所声明的整个产品的环保使用期限。

本产品在使用寿命结束时不可作为普通生活垃圾处理，应被单独收集妥善处理。

请注意：环保使用期限50年的指定不是与产品的耐久力，使用期限或任何担保要求等同的。

This symbol to be added to all EIO sold to China, indicates the product contains hazardous materials in excess of the limits established by the Chinese standard SJ/T11363-2006 *Requirements for Concentration Limits for Certain Hazardous Substances in Electronic Information Products*. The number in the symbol is the Environment-friendly Use Period (EFUP), which indicates the period, starting from the manufacturing date, during which the toxic or hazardous substances or elements contained in electronic information products will not leak or mutate under normal operating conditions so that the use of such electronic information products will not result in any severe environmental pollution, any bodily injury or damage to any assets, the unit of the period is "Year".

In order to maintain the declared EFUP, the product shall be operated normally according to the instructions and environmental conditions as defined in the product manual, and periodic maintenance schedules specified in Product Maintenance Procedures shall be followed strictly.

Consumables or certain parts may have their own label with an EFUP value less than the product. Periodic replacement of those consumables or parts to maintain the declared EFUP shall be done in accordance with the Product Maintenance Procedures.

This product must not be disposed of as unsorted municipal waste, and must be collected separately and handled properly after decommissioning.

Please note: The designation of 10 years EFUP is not to be equated with the durability, use-duration or any warranty-claims of the product.

产品中有毒有害物质或元素的名称及含量

Table of hazardous substances name and concentration

部件名称 Component Name	有毒有害物质或元素 Hazardous substances name					
	铅 (Pb)	汞 (Hg)	镉 (Cd)	六价铬 (Cr (VI))	多溴联苯 (PBB)	多溴二苯醚 (PBDE)
EMA-MB91FV460B-001	○	○	○	○	○	○

O: 表示该有毒有害物质在该部件所有均质材料中的含量均在SJ/T11363-2006 标准规定的限量要求以下

X: 表示该有毒有害物质至少在该部件的某一均质材料中的含量超出SJ/T11363-2006 标准规定的限量要求

- 此表所列数据为发布时所能获得的最佳信息
- 由于缺少经济上或技术上合理可行的替代物质或方案，此医疗设备运用以上一些有毒有害物质来实现设备的预期临床功能，或给人员或环境提供更好的保护效果。

O: Indicates that this toxic or hazardous substance contained in all of the homogeneous materials for this part is below the limit requirement in SJ/T11363-2006.

X: Indicates that this toxic or hazardous substance contained in at least one of the homogeneous materials used for this part is above the limit requirement in SJ/T11363-2006.

- Data listed in the table represents best information available at the time of publication

14 Recycling

Gültig für EU-Länder:

Gemäß der Europäischen WEEE-Richtlinie und deren Umsetzung in landesspezifische Gesetze nehmen wir dieses Gerät wieder zurück.

Zur Entsorgung schicken Sie das Gerät bitte an die folgende Adresse:

Fujitsu Microelectronics Europe GmbH
Warehouse/Disposal
Monzastraße 4a
D-63225 Langen

Valid for European Union Countries:

According to the European WEEE-Directive and its implementation into national laws we take this device back.

For disposal please send the device to the following address:

Fujitsu Microelectronics Europe GmbH
Warehouse/Disposal
Monzastraße 4a
D-63225 Langen
GERMANY