



Since 1959

Product Information Sheet

889 12V 27W

889

2010. 12. 13 NEW

2009. 05. 07 OLD

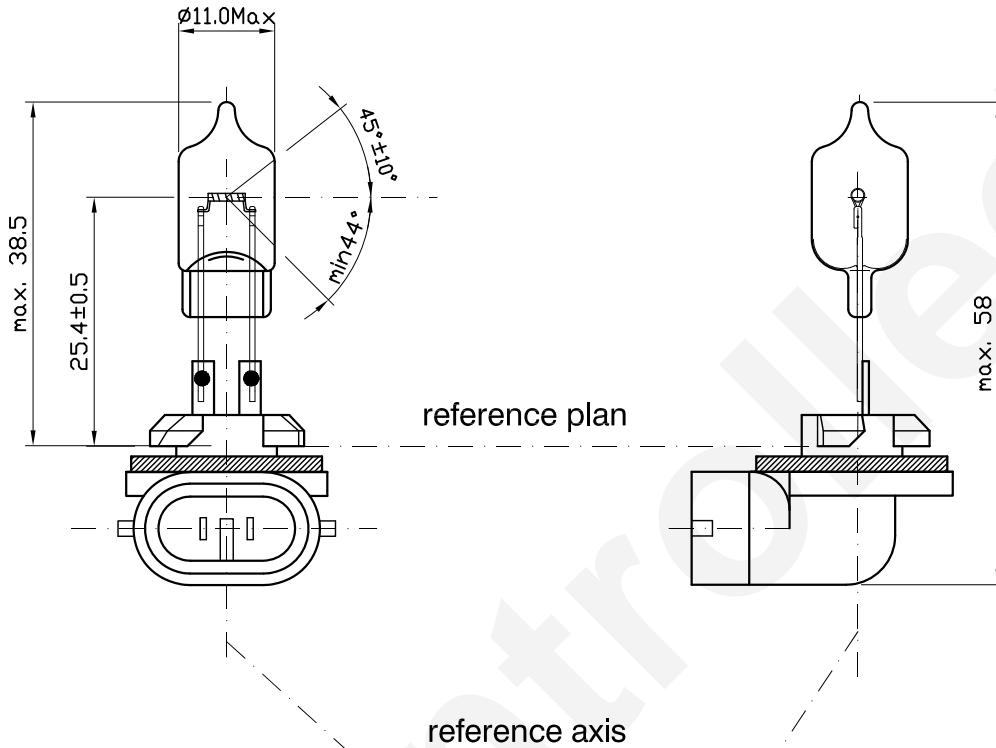

* all dimensions in mm

Halogen bulb	
889 12V 27W	
Cap: 1)	PGJ13
Type:	889
ECE R37	none
FMVSS108	none
Bulb mat.:UV-cut Hardglass	
Made in korea / INCHEON	

1) according to IEC 61-1 sheet 7004-107-1

Technical data	
Test voltage	12.8V
Power	30W max
Luminous flux	540lm ±15%
Lumen maintenance	85 % min
Rated life:	at 14.0V -Average 300 hr

Maximum operating temperature:	bulb 650°C max pinch 400°C max
Operating position	horizontal