

# SV4 SERIES ANTI-VANDAL SWITCH

ANTI-VANDAL SWITCHES  
DETECTOR SWITCHES  
DIP SWITCHES  
KEYLOCK SWITCHES  
NAVIGATION SWITCHES  
PUSHBUTTON SWITCHES  
ROCKER SWITCHES  
ROTARY SWITCHES  
SLIDE SWITCHES  
SNAP ACTION SWITCHES  
TACTILE SWITCHES  
TOGGLE SWITCHES  
CAP OPTIONS

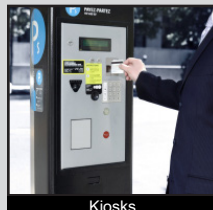

## APPLICATIONS / MARKETS

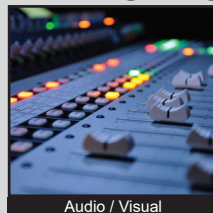

## SPECIFICATIONS

**Electrical Rating:** 2A, 36VDC  
**Electrical Life:** 200,000 Cycles  
**Contact Resistance:** 50mΩ Max. at 1A 12VDC  
**Dielectric Strength:** 2,000V RMS at sea level  
**Operating/Storage Temperature:** -20°C to 70°C  
**Travel:** 1.80mm  
**Moisture Protection:** IP67  
**Contact Arrangement:** SPST  
**Actuation Force:** 4.5 N  
**Panel Thickness:** 1-6mm  
**Mounting Nut Torque:** 1-3Nm

## FEATURES & BENEFITS

- Short body design
- 19mm diameter panel cutout
- Multiple LED options
- Ring or Ring/Power symbol illumination available
- IP67 rated
- SPST
- Soldered wire leads (500mm long) optional

## PART NUMBER CONFIGURATOR

Series	Actuator Options	Terminal Options	Function Options	Body Finish Options	Actuator Finish Options	Lens Style Options	LED-Color Options	Illumination Voltage Options
<input type="text" value="SV4"/>	<input type="text" value="F - Flat"/>	<input type="text" value="2 - Solder&lt;br/&gt;W - Wire Leads&lt;br/&gt;500mm long"/>	<input type="text" value="3 - 1 Pole&lt;br/&gt;Off - (On)*"/>	<input type="text" value="S - Stainless Steel"/>	<input type="text" value="S - Stainless Steel"/>	<input type="text" value="3 - Ring moveable with Actuator&lt;br/&gt;6 - Ring /Power moveable with Actuator"/>	<input type="text" value="0 - White&lt;br/&gt;1 - Red&lt;br/&gt;3 - Green&lt;br/&gt;4 - Blue&lt;br/&gt;5 - Yellow&lt;br/&gt;G - Red/Green&lt;br/&gt;H - Red/Blue"/>	<input type="text" value="1 - Base Voltage"/>

NOTES:  
 \*( ) denotes function is momentary

Specifications subject to change without notice 3.5.2020



**E-SWITCH®**

www.e-switch.com

800.867.2717

1

# SV4 SERIES ANTI-VANDAL SWITCH

## BODY DIMENSIONS

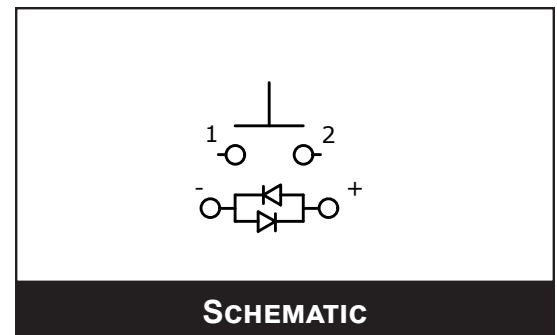
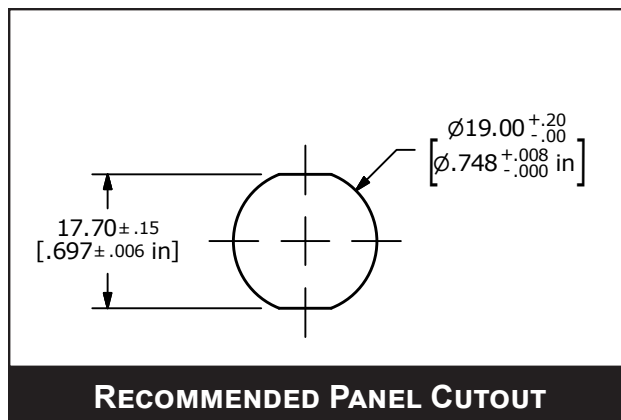
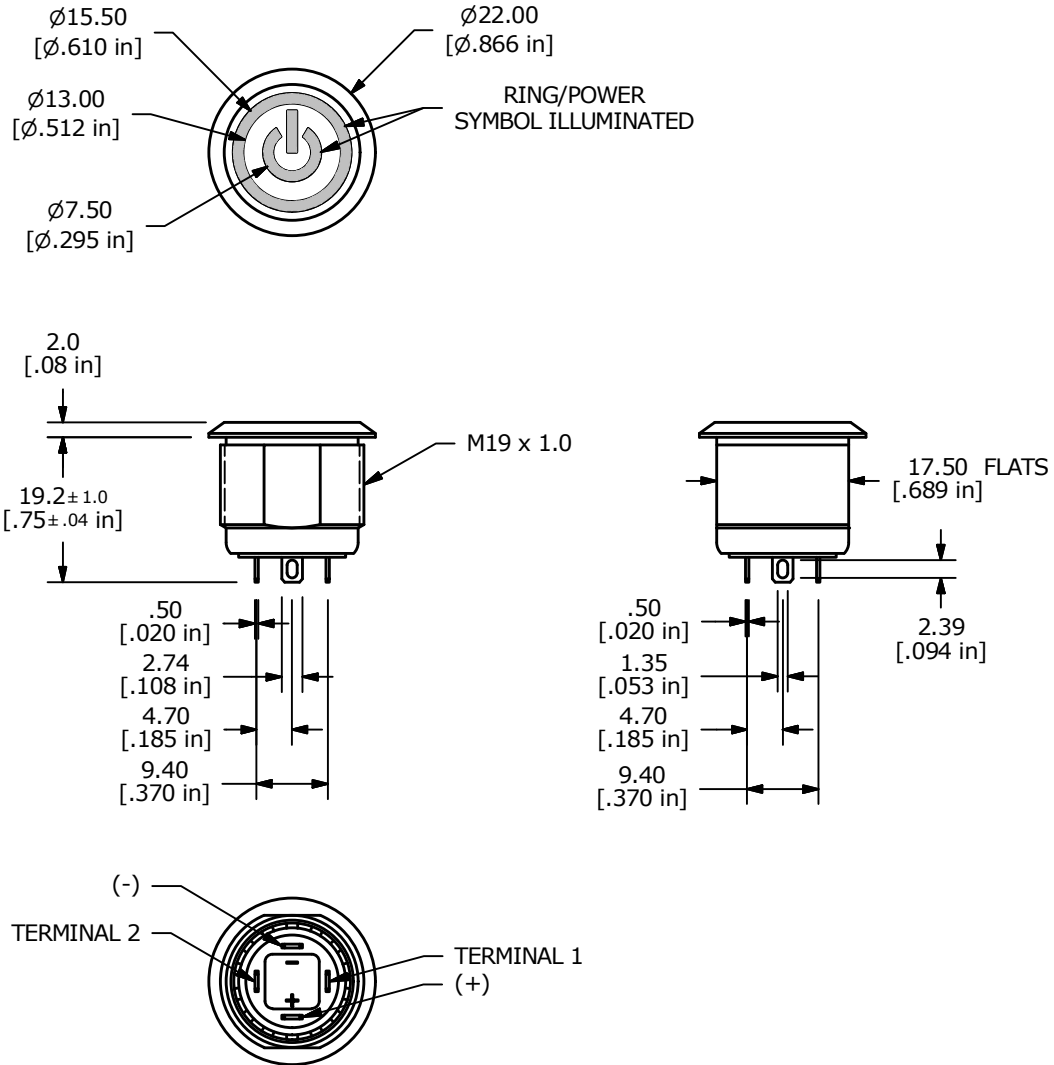

- ANTI-VANDAL SWITCHES
- DETECTOR SWITCHES
- DIP SWITCHES
- KEYLOCK SWITCHES
- NAVIGATION SWITCHES
- PUSHBUTTON SWITCHES
- ROCKER SWITCHES
- ROTARY SWITCHES
- SLIDE SWITCHES
- SNAP ACTION SWITCHES
- TACTILE SWITCHES
- TOGGLE SWITCHES
- CAP OPTIONS

# SV4 SERIES ANTI-VANDAL SWITCH

## ACTUATOR OPTIONS

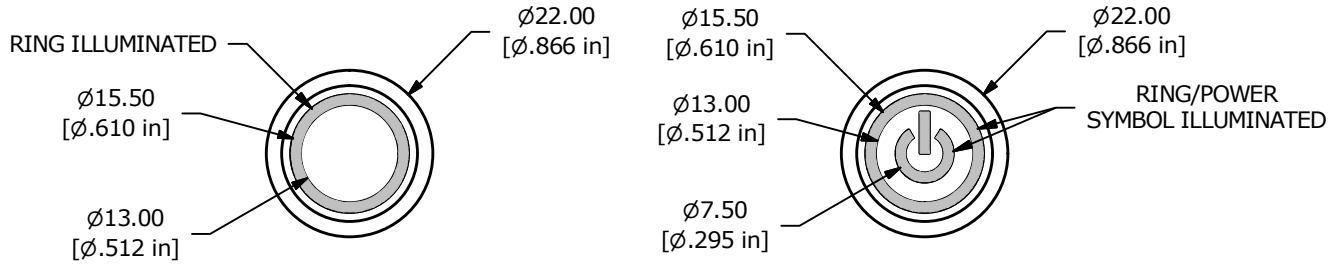

## WIRE LEAD OPTION

SWITCH	WIRE	LENGTH
SW1-1	WIRE, 20AWG AWM UL3385, BLACK	500.0 [19.7 in]
SW1-2	WIRE, 20AWG AWM UL3385, BLACK	500.0 [19.7 in]
SW1- (-)	WIRE, 20AWG AWM UL3385, GREEN	500.0 [19.7 in]
SW1- (+)	WIRE, 20AWG AWM UL3385, RED	500.0 [19.7 in]

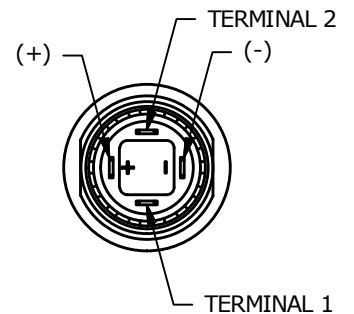
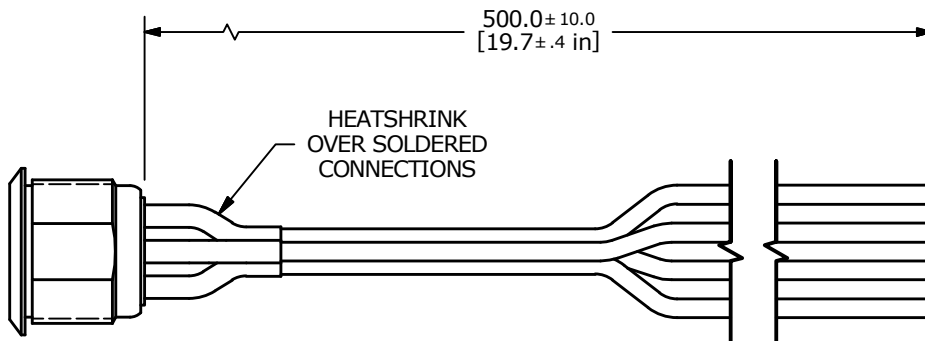

BOTTOM VIEW  
SHOWN WITHOUT  
WIRING

