

# User Manual

## POC-S198

19" Slim Point-of-Care  
Terminal with True Flat Panel  
and IP54 Enclosure

**ADVANTECH**

*Enabling an Intelligent Planet*

## Instructions for the User

The document combines text and illustrations, providing a comprehensive overview of the system. The information is presented as a sequential series of actions, allowing the user to learn directly how to use the device.

The text provides explanations and instructs the user step-by-step in the practical use of the product, with short, clear instructions in an easy-to-follow sequence.

## Definitions

**Warning!** A **WARNING** statement provides important information about a potentially hazardous situation which, if not avoided, could result in death or serious injury.



**Caution!** A **CAUTION** statement provides important information about a potentially hazardous situation which, if not avoided, may result in minor or moderate injury to the user or patient or in damage to the equipment or other property.



**Note!** A **NOTE** provides additional information intended to avoid inconveniences during operation.



## Safety Instructions

1. Strictly follow these Instructions for Use; please read these safety instructions carefully.
2. Please keep this User Manual for later reference; any use of the product requires full understanding and strict observation of all portions of these instructions. Observe all **WARNINGS** and **CAUTIONS** as rendered throughout this manual and on labels on the equipment.
3. Repair of the device may only be carried out by trained service personnel. Advantech recommends that a service contract be obtained with Advantech Service and that all repairs also be carried out by them. Otherwise the correct functioning of the device may be compromised.

**Warning!** Because of the danger of electric shock, never remove the cover of



device while it is in operation or connected to a power outlet.



Charge your optional battery pack in high temperature environment may cause damage, please let the POC or battery cool down to ambient temperature before charging.

Part No. 2008S19810

Edition 1

Printed in Taiwan

April 2013

4. If one of the following situations arises, have the equipment checked by service personnel:
  - The power cord or plug is damaged.
  - Liquid has penetrated into the equipment.
  - The equipment has been exposed to moisture.
  - The equipment does not work well, or you cannot get it to work according to the user manual.
  - The equipment has been dropped and damaged.
  - The equipment has obvious signs of breakage.
5. Disconnect this equipment from any AC outlet before cleaning. Use a damp cloth. Do not use liquid or spray detergents for cleaning and keep this equipment away from humidity.

**Caution!** *To avoid short-circuiting and otherwise damaging the device, do not allow fluids to come in contact with the device. If fluids are accidentally spilled on the equipment, remove the affected unit from service as soon as possible and contact the service personnel to verify that patient safety is not compromised.*



6. Put this equipment on a reliable surface during installation. Dropping it or letting it fall may cause damage. For plug-in equipment, the power outlet socket must be located near the equipment and must be easily accessible.

**Caution!** *To prevent overheating, do not cover the openings or place the device in*



*direct sunlight or near radiant heaters.*

7. Make sure the voltage of the power source is correct before connecting the equipment to the power outlet. Position the power cord so that people cannot step on it. Do not place anything over the power cord. If the equipment is not used for a long time, disconnect it from the power source to avoid damage by transient over voltage.

**Caution!** *Do not leave this equipment in an uncontrolled environment where the storage temperature is below -20° C (-4° F) or above 60° C (140° F). This may damage the equipment.*



8. If your computer does not keep the correct time or the BIOS configuration has been reset to default, the battery may have no charge.

**Caution!** *Do not replace battery yourself. Please contact a qualified technician or your retailer.*



*The computer is provided with a battery-powered, real-time clock circuit. There is a danger of explosion if battery is incorrectly replaced. Replace only with same or equivalent type recommended by the manufacturer. Discard used batteries according to the manufacturer's instructions.*

**Caution!** *The battery charging indicator is not included with this device. It will be added to the finished system assembly and be shown with the completed system.*



9. Improper installation of VESA mounting can result in serious personal injury! VESA mount installation should be operated by professional technician, please contact the service technician or your retailer if you need this service. The detail operating procedure is specified in Appendix A.
10. Classification:
  - 1). Supply Class I adapter
  - 2). No applied part
  - 3). IPX1
  - 4). Continuous Operation
  - 5). Not AP or APG category

**Warning!** *This device is not suitable for use in the presence of flammable anes-*



*thetic mixture with air, oxygen, nitrous oxide, or for life support systems.*

11. Environmental protection: follow national requirements to dispose of unit.
12. Maintenance: to properly maintain and clean the surfaces, use only the approved products or clean with a dry applicator.

**Caution!** *When servicing the device, always use replacement parts that are qualified to Advantech standards. Advantech Digital Healthcare cannot warrant or endorse the safe performance of third-party replacement parts for use with our medical device.*



13. Make sure the user does not allow contact between SIP/SOPs and the patient at the same time.
14. When networking with electrical devices, the operator is responsible for ensuring that the resulting system meets the requirements set forth by the following standards:
  - EN 60601-1 (IEC 60601-1)  
Medical electrical equipment  
Part 1: General requirements for safety
  - EN 60601-1-1 (IEC 60601-1-1)  
Medical electrical equipment  
Part 1-1: General requirements for safety  
Collateral standard: Safety requirements for Medical electrical systems
  - EN 60601-1-2 (IEC 60601-1-2)  
Medical electrical equipment  
Part 1-2: General requirements for safety  
Collateral standard: Electromagnetic compatibility; Requirements and tests



**Medical Equipment**  
With Respect to Electric Shock,  
Fire, and Mechanical Hazards Only,  
In Accordance with UL 60601-1,  
CAN/CSA C22.2 No. 601.1, and  
IEC 60601-1

15. Accessory equipment connected to analog and digital interfaces must be in compliance with the respective nationally harmonized IEC standards (i.e. IEC 60950 for data processing equipment, IEC 60065 for video equipment, IEC 61010-1 for laboratory equipment, and IEC 60601-1 for medical equipment.)

Furthermore all configurations shall comply with the system standard IEC 60601-1-1. Anyone who connects additional equipment to the signal input part or signal output part is configuring a medical system, and is therefore, responsible that the system complies with the requirements of the system standard IEC 60601-1-1. The unit is for exclusive interconnection with IEC 60601-1 certified equipment in the patient environment and IEC 60XXX certified equipment outside of the patient environment. If in doubt, consult the technical services department or your local representative.

**Caution!** Use suitable mounting apparatus to avoid risk of injury.



16. Grounding reliability can only be achieved when the equipment is connected to an equivalent receptacle marked "Hospital Only" or "Hospital Grade".
17. Use a power cord that matches the voltage of the power outlet, which has been approved and complies with the safety standard of your particular country.

**Note!** Environmental protection



Follow national requirements to dispose of unit.

## Explanation of Graphical Symbols



IEC 60878 and ISO 3864-B.3.6 : Warning: dangerous voltage



ISO 7000-0434 : Caution, consult ACCOMPANYING DOCUMENTS.



ISO 7000-1641 : Follow operating instructions or consult instructions for use.



IEC 60417 -5009 : STAND-BY.



IEC 60417-5031 : Direct current.



IEC 60417-5021 : Equipotentiality.

# Disposing of Old Products

## Within the European Union



EU-wide legislation, as implemented in each member state, requires that waste electrical and electronic products carrying the mark shown at left must be disposed of separately from normal household waste. This includes monitors and electrical accessories, such as signal cables or power cords. When you need to dispose of your display products, please follow the guidance of your local authority, or ask the shop where you purchased the product, or if applicable, follow any agreements made between you and the provider.

The mark on electrical and electronic products only applies to the current European Union Member States.

## FCC Class B

This equipment has been tested and found to comply with the limits for a Class B digital device, pursuant to Part 15 of the FCC Rules.

These limits are designed to provide reasonable protection against harmful interference when the equipment is operated in a residential environment. This equipment generates, uses and can radiate radio frequency energy. If not installed and used in accordance with this user manual, it may cause harmful interference to radio communications.

Note that even when this equipment is installed and used in accordance with this user manual, there is still no guarantee that interference will not occur. If this equipment is believed to be causing harmful interference to radio or television reception, this can be determined by turning the equipment on and off. If interference is occurring, the user is encouraged to try to correct the interference by one or more of the following measures:

- Reorient or relocate the receiving antenna
- Increase the separation between the equipment and the receiver
- Connect the equipment to a power outlet on a circuit different from that to which the receiver is connected
- Consult the dealer or an experienced radio/TV technician for help

**Warning!** *Any changes or modifications made to the equipment which are not expressly approved by the relevant standard's authority could void your authority to operate the equipment.*



## List of Accessories

Before installing your Point-of-Care Terminal, ensure that the following materials have been received:

- POC-S198 series Point-of-Care Terminal
- Accessories for POC-S198
- CD-ROM disc-"Drivers, User's manual and Utilities"
- Mounting kits and packet of screws.
- VESA mounting note x1
- China RoHs note x1

**Warning!** *No user serviceable parts inside; refer servicing to qualified personnel. Only the accessories indicated on the list of accessories above have been tested and approved to be used with the device. Accordingly it is strongly recommended that only these accessories be used in conjunction with the specific device. Otherwise the correct functioning of the device may be compromised.*



## Additional Information and Assistance

Contact your distributor, sales representative, or Advantech's customer service center for technical support if you need additional assistance. Please have the following information ready before you call:

- Product name and serial number
- Description of your peripheral attachments
- Description of your software (operating system, version, application software, etc.)
- A complete description of the problem
- The exact wording of any error messages
- This equipment is a source of electromagnetic waves. Before use please, make sure that there are not EMI sensitive devices in its surrounding which may malfunction therefore.

### Environmental protection

- Follow national requirements to dispose of unit.

#### **Manufacturer:**

Advantech Co., Ltd.

No.1, Alley 20, Lane 26, Rueiguang Road Neihu District, Taipei,

Taiwan 114, R.O.C.

TEL: (02) 2792-7818

#### **Distributed in Europe by:**

Advantech Europe GmbH Kolberger Straße 7

D-40599 Düsseldorf, Germany

Tel: 49-211-97477350

Fax: 49-211-97477300

Visit the Advantech websites at [www.advantech.com](http://www.advantech.com) or [www.advantech.com.tw](http://www.advantech.com.tw) if you need more information.





# Contents

<b>Chapter 1</b>	<b>General Information .....</b>	<b>1</b>
1.1	Introduction .....	2
1.2	Specifications .....	2
1.3	Dimensions .....	4
	Figure 1.1 Dimensions of the POC-S198 .....	4
	Figure 1.2 VESA Mounting of the POC-S198 .....	4
	Figure 1.3 POC-S198 Front Panel.....	5
	Figure 1.4 POC-S198 Back I/O .....	5
1.3.1	Optional Modules .....	5
1.4	Point-of-Care Terminal Cleaning and Disinfecting .....	6
<b>Chapter 2</b>	<b>System Setup .....</b>	<b>7</b>
2.1	A Quick Tour of the POC-S198 .....	8
2.1.1	Front View.....	8
	Figure 2.1 Front View of the Point-of-Care Terminal .....	8
2.1.2	Bottom View.....	9
	Figure 2.2 Bottom View .....	9
2.1.3	Rear View .....	9
	Figure 2.3 Rear view of the Point-of-Care Terminal .....	9
	Figure 2.4 Rear view of Multi I/O ports .....	10
2.2	Installation Procedures.....	11
	2.2.1 Connecting the Power Cord .....	11
	Figure 2.7 Connecting the Power Cord .....	12
	2.2.2 Connecting the Ground Pin.....	12
	Figure 2.8 POC-S198 Equipotential Terminal Pin .....	12
	Figure 2.9 Grounding cable with connector .....	12
2.3	Running the BIOS Setup Program .....	13
2.4	Installing System Software .....	13
2.5	Installing the Drivers.....	13
	Table 2.1: The file directory on "Drivers and Utilities" CD-ROM	14
<b>Chapter 3</b>	<b>Driver Installation .....</b>	<b>21</b>
3.1	Introduction .....	22
3.2	Automatic Driver Installation .....	22
<b>Chapter 4</b>	<b>Utilities and Hot Fixes .....</b>	<b>23</b>
4.1	Introduction .....	24
4.2	Wakeup by External USB Device at S3 Resume (Wakeup) .....	24
4.2.1	Installation for Windows XP .....	24
<b>Chapter 5</b>	<b>Operation and Safety Information....</b>	<b>25</b>
5.1	General Safety Guide.....	26
5.2	Protecting Your Optical Drive.....	26

	5.3	Thermal .....	26
	5.4	Disconnect the Power .....	26
<b>Chapter</b>	<b>6</b>	<b>PCM-8713 Connector Map and Table ..</b>	<b>29</b>
	6.1	Motherboard Top Side .....	30
	6.2	Motherboard Bottom Side .....	30
		Table 6.1: MB Connector Table .....	31
	6.3	I/O Board .....	31
		Table 6.2: I/O Connector Table .....	32
<b>Chapter</b>	<b>7</b>	<b>PCM-8713 Jumper Settings .....</b>	<b>33</b>
	7.1	Motherboard .....	34
		Figure 7.1 PCM-8709 Motherboard Top Side .....	34
	7.2	I/O Board .....	34
		Figure 7.2 PCM-8709 I/O Top Side .....	34
		Table 7.1: Jumper Settings: .....	35
		Table 7.2: CN: Clear CMOS .....	35
		Table 7.3: CN2: Clear ME .....	35
		Table 7.4: CN3: VBIOS Setup .....	36
		Table 7.5: CN3: Select Boot Main Display Setup .....	36
		Table 7.6: CN4: ME Manufacturing Mode .....	36
		Table 7.7: CN8: System Reset .....	37
		Table 7.8: CN12 (MB): LVDS Voltage Select .....	37
		Table 7.9: CN12 (IO): COM1 RS-232/422/485 Output Type Set- tings .....	37
<b>Chapter</b>	<b>8</b>	<b>Front Bezel Button .....</b>	<b>39</b>
	8.1	Introduction .....	40
		8.1.1 Front Button Map .....	40
<b>Chapter</b>	<b>9</b>	<b>POC-S198 Advanced BIOS Function .</b>	<b>41</b>
	9.1	Introduction .....	42
<b>Appendix A</b>		<b>POC-S198 VESA Mounting .....</b>	<b>45</b>
	A.1	Install VESA Mounting .....	46
		Figure A.1 VESA Mounting 75x75mm, 100x100 mm .....	46

# Chapter 1

General Information

## 1.1 Introduction

The POC-S198 is a multimedia Intel® Core™ i7 processor series designed for mobile computing as a Point-of-Care terminal (POC.) It is a PC-based system with 19" wide screen TFT LCD display, single VGA Port, HDMI out, dual on-board 10/ 100/1000 PCI-E Ethernet controllers, and one LAN port. It supports the Intel AMT7.0 function, has dual COM ports, quad USB 2.0 ports and a 24-bit stereo audio control- ler. With an optional 2.5" SATA drive, the POC-S198 is a user-friendly computer. For system integrators, this highly integrated multimedia system lets you easily build a Point-of-Care Terminal into your applications. The POC-S198 makes it an ideal and safe point-of-care solution for patients and hospital practitioners.

The POC-S198 is specially designed to resist spills and water damage, and ensures dust resistance with its protected LCD and sealed ports. The POC-S198 is a reliable solution to your application's processing requirements.

**Intended use** - The POC-S198 is intended to serve as a Point-of-Care terminal (POC) for integration with hospital systems. POC-S198 is designed for general purpose medical computing in the hospital environment, for data collection and for displaying information.

It should not be used as a life-support system.

The latest version of this user manual is available for download from <http://support.advantech.com.tw/support/>

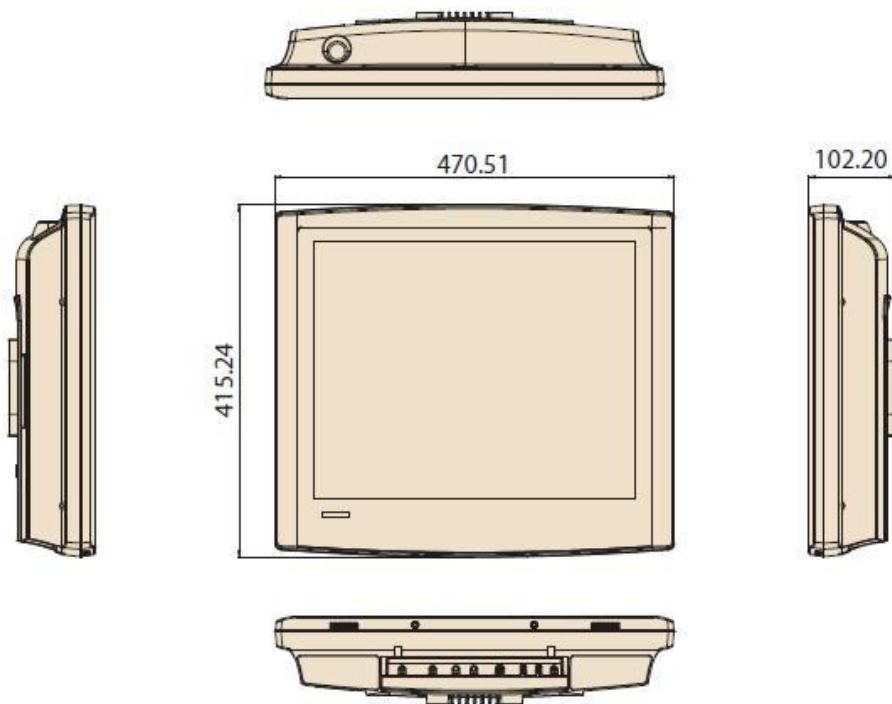
## 1.2 Specifications

Computing System	Chipset	Intel QM67
	CPU	Intel Core i7-3555LE Processor (4M Cache, 2.5 GHz, up to 3.2 GHz)
	Front Side Bus	Internal CPU
	Memory	Up to 16 GB DDR3 1600 MHz SDRAM
	Graphics Controller	1 Integrated Intel HD Graphics
	Operating System	XPP, Win 7
Display	Display Size	19" TFT-LCD (4:3)
	Max. Resolution	1280 x 1024 (H x V)
	Max. Colors	16.7 M colors
	Pixel Pitch (mm)	0.294 x 0.294
	Viewing Angle	1 178°/178° *
	Luminance	300 cd/m2 *
	Backlight	LED
	LCD MTBF	50,000 Hours
Contrast Ratio	2000 : 1	
Expansion Slot	Mini PCIe	1 x Mini PCI-E slot
Storage	HDD	1 x 2.5" SATA

I/O Ports		Type A	Type B
	Serial Ports	1 x RS-232 (isolated) and 1 x RS-232/422/485 (isolated) serial port	1 x RS-232 2 x RS-232 (isolated) 1 x RS-232/422/485 (isolated) serial port
	USB 2.0 Ports	4	3
	DVI Ports	1	-
	Speakers (1W)	2 x 2W	2 x 2W
	LAN	2 x Gigabit Ethernet (isolated) interfaces (RJ-45)	1 x Gigabit Ethernet (isolated) interfaces
Storage	HDD or SSD	1 x 2.5" SATA	
Power Supply	DC Model	AC/DC adapter (Sinpro Model no.HPU101-107)	
	Input Voltage	90 ~ 260 VAC, 1.35 ~ 0.5 A, 47 ~ 63 Hz	
	Output Voltage	+18 VDC, 5.55 A max. (100 watts)	
Optional Functions	Battery	3S2P 4200mAH, supports 0.5 hr backup operation	
	Smart Card Reader	Complies with ISO7816-1,2,3,T=1 and T=0 protocol; Factory build for TPN process only.	
	WLAN	Integrated wireless 802.11 a/b/g/n connection & internal antenna	
	RFID	13.56 MHz with ISO-15693 & ISO-14443A/B and active tag function	
	Bluetooth	Integrated Bluetooth v4.0	
Optional Touchscreen	Type	Analog Resistive	Projected Capacitive 4-points
	Resolution	81%	90%
	Controller	RS-232 interface (use COM6)	USB Interface
IP Rating	Full System	IP54	
Certifications	UL60601-1/EN60601-1, CE & FCC Class B certified		
Environment	Temperature	0 ~ 40° C (32 ~ 104° F) (Operating)	
	Humidity	10 ~ 95% @ 40° C (Non-condensing)	
	Shock Resistance	20 G peak acceleration (11 ms duration)	
Physical Characteristics	Dimensions (W x H x D)	470.5 x 415.2 x 102.2 mm (18.52" x 16.35" x 4.02")	
	Weight	7.5 Kg (16.5 lb)	

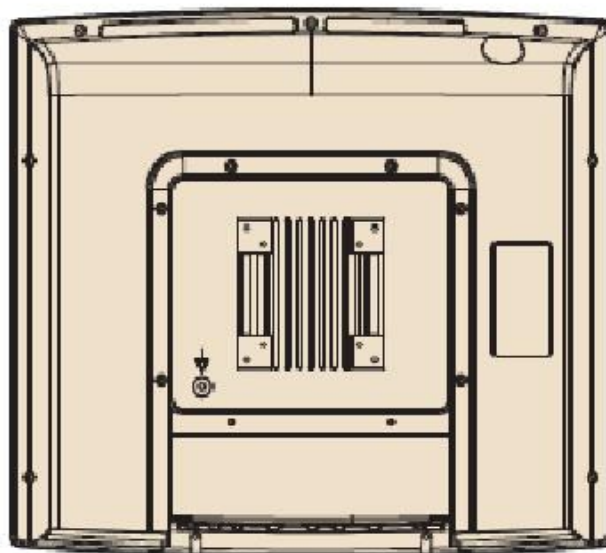
## 1.3 Dimensions

Dimensions: 550 x 370 x 65 mm (Unit: mm)



**Figure 1.1 Dimensions of the POC-S198**

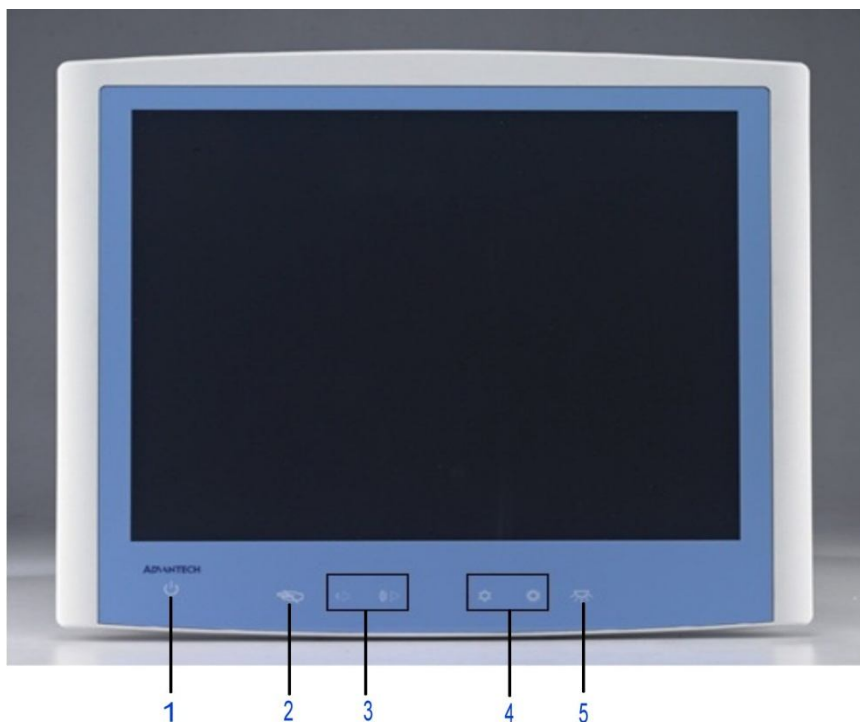
VESA Mounting: 75 x 75 mm; 100 x 100 mm



**Figure 1.2 VESA Mounting of the POC-S198**

**Warning!** Use suitable mounting apparatus to avoid risk of injury.

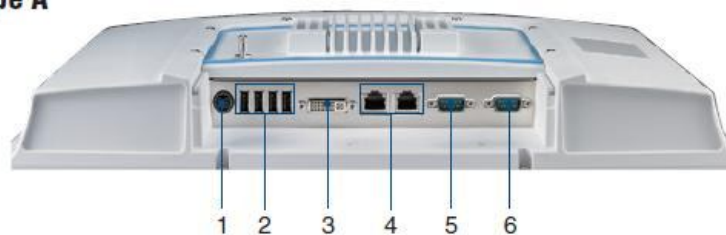




**Figure 1.3 POC-S198 Front Panel**

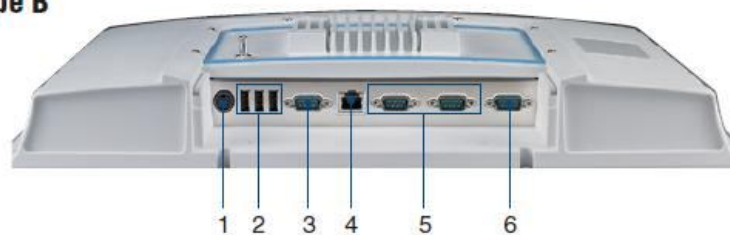
- (1) Power
- (2) Touchscreen Status Control
- (3) Volume Down/Up
- (4) Touchscreen Status Control
- (5) Read Light Control

**Type A**



**Figure 1.4 POC-S198 Back I/O**

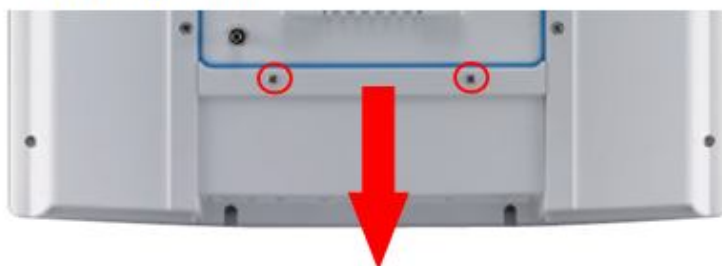
- (1) DC-IN
- (2) USB 2.0 x4
- (3) DVI-Ix1
- (4) GigaLAN x2
- (5) RS-232 x1
- (6) RS-232/422/485 x1

**Type B**

- Figure 1.5 POC-S198 Back I/O**
- (1) DC-IN
  - (2) USB 2.0 x3
  - (3) RS-232 x1
  - (4) GigaLAN x2
  - (5) RS-232 x2
  - (6) RS-232/422/485 x1

### 1.3.1 How to setup IP54 wiring

- 1) Remove screws circled and take off exterior I/O cover by sliding it downward.

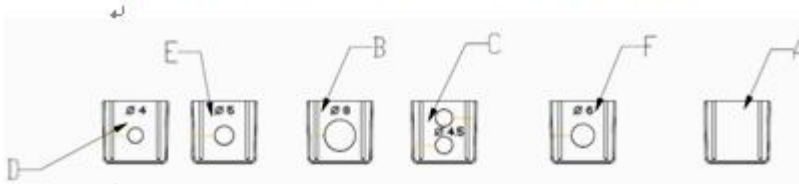


- 2) Insert appropriate rubber connectors into appropriate slots and place cables in holes.





Suggestion of suitable hole sizes for your reference:↵



- A. Original↵
- B. 8 Φ for VGA cable↵
- C. 2 x 4.5 Φ for USB cable↵
- D. 4 Φ for USB cable↵
- E. 5 Φ for LAN or COM cable↵
- F. 6 Φ for Power or HDMI cable↵

3) Place back I/O exterior cover.↵



### 1.3.2 Optional Modules

- Battery Module(4200mAh Li-ion battery)
- RFID module
- Bluetooth module
- WLAN module(802.11a/b/g/n)

## 1.4 Point-of-Care Terminal Cleaning and Disinfecting

During normal use of the POC (Point-of-Care Terminal) the device may become dirty and should be regularly cleaned.

### Steps:

1. Prepare cleaning agent per manufacturer's instructions or hospital protocol.
2. Wipe the POC with a clean cloth that has been moistened in the cleaning solution.
3. Wipe thoroughly with a clean cloth.

Cleaning agent list: chemical disinfectants which have been tested on the POC

No	Cleaning Agents
1	Cidex
2	Isopropyl alcohol
3	Green tinctured soap
4	Windex
5	Alcohol
6	Alcohol 70%
7	Chloride 1000PPM
8	Incidin plus
9	Incidin liquid
10	Mikrozid liquid

### Caution!



- *Do not immerse or rinse the POC or its peripherals. If you accidentally spill liquid on the device, disconnect the unit from the power source. Contact your Biomed Department regarding the continued safety of the unit before placing it back in operation.*
- *Do not spray cleaning agents on the chassis.*
- *Do not use disinfectants that contain phenol. Do not autoclave or clean the POC or its peripherals with strong aromatic, chlorinated, ketone, ether, or Esther solvents, sharp tools or abrasives. Never immerse electrical connectors in water or other liquids.*

# Chapter 2

## System Setup

## 2.1 A Quick Tour of the POC-S198

Before you start to set up the POC-S198, take a moment to become familiar with the locations and purposes of the controls, drives, connections and ports, which are illustrated in the figures below.

When you place the POC-S198 upright on the desktop, its front panel appears as shown in Figure 2.1.

### 2.1.1 Front View

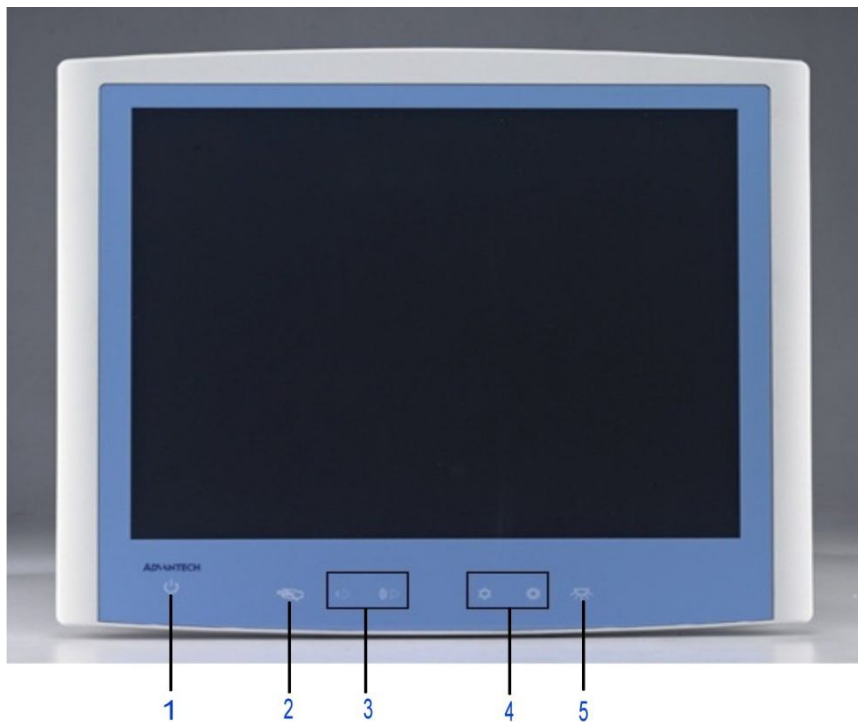


**Figure 2.1 Front View of the Point-of-Care Terminal**

#### Front Bezel View

- (1) LCD panel with Touchscreen option (Touchscreen Enabled: Green light)
- (2) Power symbol w/ indicator light (Power on: Green light)

## 2.1.2 Bottom View



### Bottom View:

- (1) Power
- (2) Touchscreen Status Control
- (3) Volume Down/Up
- (4) Touchscreen Status Control
- (5) Read Light Control

## 2.1.3 Rear View

When you turn the Point-of-Care Terminal around and look at its rear cover, the sunken I/O section is at the bottom of the panel PC, as shown in Figure 2.3 and Figure 2.4 (zoom view). (The I/O section includes various I/O ports, including serial ports, VGA, HDMI, Ethernet port, USB ports and so on.)

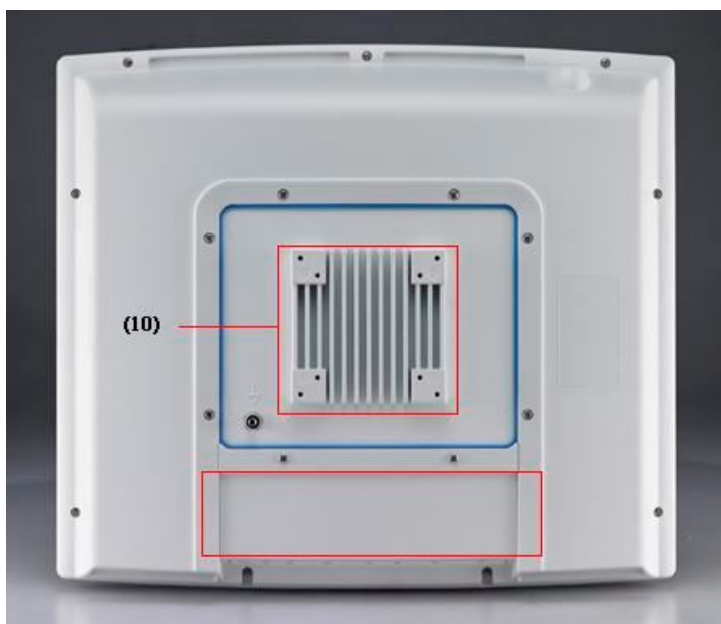


Figure 2.3 Rear view of the Point-of-Care Terminal

**Type A**

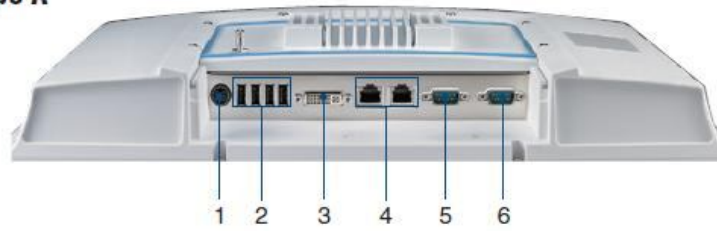
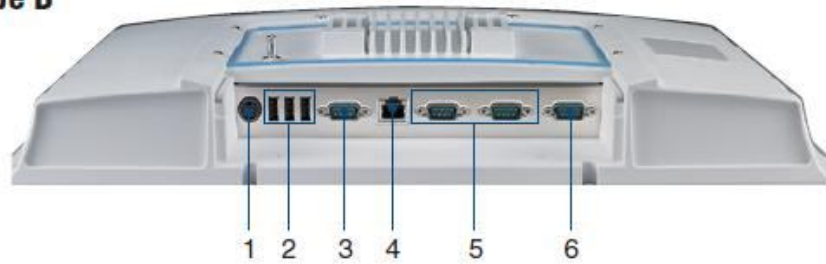


Figure 2.4 Rear view of Multi I/O ports

**Rear View:**

- (1) DC-IN
- (2) USB 2.0 X4
- (3) DVI-I X1
- (4) GigaLAN X2
- (5) RS-232 X1
- (6) RS-232/422/485 X1

**Type B**



**Rear View:**

- (1) DC-IN
- (2) USB 2.0 X3
- (3) RS-232 X1
- (4) GigaLAN X2
- (5) RS-232 X2
- (6) RS-232/422/485 X1



**Note!** *Equipotential terminals need a link to hospital ground/earth system before the system boots to protect operator and system.*

## 2.2 Installation Procedures

### 2.2.1 Connecting the Power Cord

The POC-S198 can only be powered by a DC power adapter (SINPRO Model no.HPU101-107). Be sure to always handle the power cords by holding the plug ends only.

Follow these procedures in order:

1. Connect the female end of the power adapter to the DC jack of the panel PC.  
(See Figure 2.7.)
2. Connect the female end of the power cord to the DC power adapter.
3. Connect the 3-pin male plug of the power cord to an electrical outlet.

**Warning!** *The POC-S198 is supplied by a 100 watt power supply and a special adapter as depicted as above model.*



*If medical adaptor is connected to the POC-S198, the customer must ensure legal and regulatory compliance and that the device meets the law and standards compliance requirements of this hardware.*

### Switching on the power:

Push down the power button on the front panel for POC-S198. (The color indicator turns green)

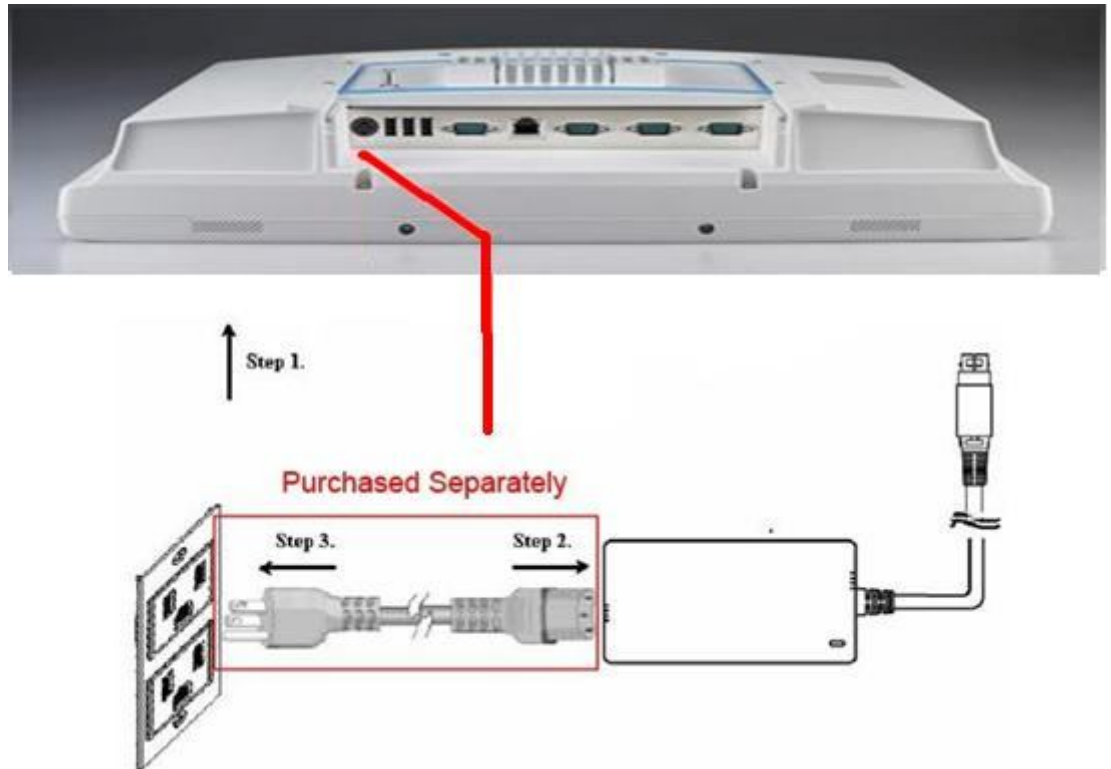


Figure 2.7 Connecting the Power Cord

### 2.2.2 Connecting the Ground Pin

1. With system ready, find the equipotential terminal on the rear side of the POC. An equipotential terminal is provided to optionally connect to a hospital ground/ earth system



Figure 2.8 POC-S198 Equipotential Terminal Pin



2. Prepare the grounding cable and the other terminal link to hospital ground/earth system.



**Figure 2.9 Grounding cable with connector**

3. Grounding cable plug with Equipotential Terminal

## 2.3 Running the BIOS Setup Program

Your POC-S198 was probably set up and configured by your dealer prior to delivery. You may still find it necessary to use the BIOS (Basic Input-Output System) setup program to change system configuration information, such as the current date and time or your type of hard drive. The setup program is stored in read-only memory. It can be accessed either when you turn on or reset the panel PC, by pressing the “F2 or Del” key on your keyboard immediately after powering on the computer.

The settings you specify with the setup program are recorded in a special area of memory called CMOS RAM. This memory is backed up by a battery so that it will not be erased when you turn off or reset the system. Whenever you turn on the power, the system reads the settings stored in CMOS RAM and compares them to the equipment check conducted during the power on self-test (POST). If an error occurs, an error message will be displayed on screen, and you will be prompted to run the setup program.

## 2.4 Installing System Software

Recent releases of operating systems from major vendors include setup programs which load automatically and guide you through hard disk preparation and operating system installation. The guidelines below will help you determine the steps necessary to install your operating system on the panel PC hard drive.

**Note!** *Some distributors and system integrators may have already pre-installed system software prior to shipment of your panel PC.*



If required, insert your operating system's installation or setup diskette into the external diskette drive until the release button pops out.

The BIOS supports system boots up directly from the CD-ROM drive. You may also insert your system installation CD-ROM disk into your external CD-ROM drive.

Power on or reset the system by pressing the “F2 or Del” key to boot into BIOS menu and adjust the boot device sequence.

You can also press F12 key when booting; a bootable device popup menu will appear, you can select bootable device that you want. The Point-of-Care Terminal will automatically load the operating system from the diskette or CD-ROM.

If you are presented with the opening screen of a setup or installation program, follow the instructions on screen. The setup program will guide you through preparation of

---

your hard drive, and installation of the operating system.

## 2.5 Installing the Drivers

After installing your system software, you will be able to set up the Chipset, Graphics, Ethernet, Audio, Touchscreen and AMT functions from your own external CD-ROM drive. All the drivers except the CD-ROM drive driver are stored in a CD-ROM disc entitled "Drivers and Utilities."

The standard automatic installation procedures for installing the Chipset, Graphics, Audio, Ethernet, AMT and Touch drivers are described in Chapter 3.

The various drivers and utilities in the CD-ROM disc have their own text files which help users install the drivers and understand their functions. These files are a very useful supplement to the information in this manual.



For your reference, the directories of drivers on the "Drivers and Utilities" CD-ROM are located as follows:

**XP Driver List:**

These drivers are located in the driver CD\Driver\XP folder

Please follow the sequence below to install driver.

Install Sequence	Folder Name	Note
1	Chipset	Please install chipset driver first.
2	Graphics	After graphics driver installation, please install Microsoft .NET Framework before reboot.
3	Microsoft .NET Framework 3.5 sp1	
4	LAN	
5	Audio	
6	AMT	
7	Touch	Please install internal resistive touch controller to COM6.
8	Option	Please install optional device in related folder

**Note!** These XP drivers are all 32-bit version.



**WIN7 64-bit Driver List:**


These drivers are located in the driver CD\Driver\WIN7 64bit folder

Please follow the sequence below to install driver.

Table 2.1: The file directory on "Drivers and Utilities" CD-ROM		
Install Sequence	Folder Name	Note
1	Chipset	Please install chipset driver first.
2	Graphics	
3	LAN	
4	Audio	
5	AMT	
6	Touch	Please install internal resistive touch controller to COM6.
7	Option	Please install optional device in related folder

**Note!** These WIN7 drivers are all 64-bit version.



**Note!**  The drivers and utilities used for the POC-S198 panel PCs are subject to change without notice. If in doubt, check Advantech's website or contact our application engineers for the latest information regarding drivers and utilities.

### Troubleshooting

When system behaves abnormally, such as:

1. Failure to power on
2. Failure to power off
3. Power LED ON but no DC power output
4. AC power in and all switches ON, but system doesn't power on

Contact your distributor, sales representative, or Advantech's customer service center for technical support if you need additional assistance. Please have the following information ready before you call:

- Product name and serial number
- Description of your peripheral attachments
- Description of your software (operating system, version, application software, etc.)
- A complete description of the problem
- The exact wording of any error messages
- Symptoms, photo or video if available.

<b>Guidance and Manufacturer's Declaration – Electromagnetic Emissions</b>		
The model POC-S198 is intended for use in an electromagnetic environment as specified below. The customer or the user of the POC-S198 should assure that it is used in such an environment.		
<b>Emissions Test</b>	<b>Compliance</b>	<b>Electromagnetic Environmental Guidance</b>
RF emissions CISPR 11	Group 1	The model POC-S198 uses RF energy only for its internal function. Therefore, its RF emissions are very low and are not likely to cause any interference in nearby electronic equipment.
RF emissions CISPR 11	Class B	The model POC-S198 is suitable for use in all establishments, including domestic establishments and those directly connected to the public low-voltage power supply network that supplies buildings used for domestic purposes.
Harmonic emissions IEC 61000-3-2	Class A	
Voltage fluctuations/ flicker emissions IEC 61000-3-3	Not applicable	

**Recommended Separation Distances Between Portable and Mobile RF Communications Equipment and the POC-S198**

POC-S198 is intended for use in an electromagnetic environment in which radiated RF disturbances are controlled. The customer or the user of the model POC-S198 can help prevent electromagnetic interference by maintaining a minimum distance between portable and mobile RF communications equipment (transmitters) and the model POC-S198 as recommended below, according to the maximum output power of the communications equipment.

Rated Maximum Output Power of Transmitter W	Separation Distance According to Frequency of Transmitter m		
	150 kHz to 80 MHz $d = 1,2 \sqrt{P}$	80 MHz to 800 MHz $d = 1,2 \sqrt{P}$	800 MHz to 2,5 GHz $d = 2,3 \sqrt{P}$
0,01	0,12	0,12	0,23
0,1	0,38	0,38	0,73
1	1,2	1,2	2,3
10	3,8	3,8	7,3
100	12	12	23

For transmitters rated at a maximum output power not listed above, the recommended separation distance  $d$  in meters (m) can be estimated using the equation in the table above applicable to the frequency of the transmitter, where  $P$  is the maximum output power rating of the transmitter in watts (W) according to the transmitter manufacturer.


NOTE 1 At 80 MHz and 800 MHz, the separation distance for the higher frequency range applies.

NOTE 2 These guidelines may not apply in all situations. Electromagnetic propagation is affected by absorption and reflection from structures, objects and people.

<b>Guidance and Manufacturer's Declaration – Electromagnetic Immunity</b>			
POC-S198 is intended for use in the electromagnetic environment specified below. The customer or the user of the model POC-S198 should assure that it is used in such an environment.			
<b>Immunity Test</b>	<b>IEC 60601 Test Level</b>	<b>Compliance Level</b>	<b>Electromagnetic Environmental Guidance</b>
Electrostatic discharge (ESD) IEC 61000-4-2	±6 kV contact ±8 kV air	±6 kV contact ±8 kV air	Floors should be wood, concrete or ceramic tile. If floors are covered with synthetic material, the relative humidity should be at least 30%.
Electrical fast transient/burst  IEC 61000-4-4	±2 kV for power supply lines  ±1 kV for input/output lines	±2 kV for power supply lines  ±1 kV for input/output lines	Main power quality should be that of a typical commercial or hospital environment.
Surge IEC 61000-4-5	±1 kV line(s) to line(s) ±2 kV line(s) to earth	±1 kV line(s) to line(s) ±2 kV line(s) to earth	Main power quality should be that of a typical commercial or hospital environment.
Interruptions and voltage variations on power supply input lines  IEC 61000-4-11	<5% <i>UT</i> (>95% dip in <i>UT</i> ) for 0,5 cycle  40% <i>UT</i> (60% dip in <i>UT</i> ) for 5 cycles  70% <i>UT</i> (30% dip in <i>UT</i> ) for 25 cycles  <5% <i>UT</i> (>95% dip in <i>UT</i> ) for 5 sec	<5% <i>UT</i> (>95% dip in <i>UT</i> ) for 0,5 cycle  40% <i>UT</i> (60% dip in <i>UT</i> ) for 5 cycles  70% <i>UT</i> (30% dip in <i>UT</i> ) for 25 cycles  <5% <i>UT</i> (>95% dip in <i>UT</i> ) for 5 sec	Main power quality should be that of a typical commercial or hospital environment. If the user of the model POC-S198 requires continued operation during main power interruption, it is recommended that the model POC-S198 be powered from an uninterruptible power supply or a battery.
Power frequency (50/60 Hz) magnetic field IEC 61000-4-8	3 A/m	3 A/m	Power frequency magnetic fields should be at levels characteristic of a typical location in a typical commercial or hospital environment.
NOTE <i>UT</i> is the A.C. main voltage prior to application of the test level.			

**Guidance and Manufacturer's Declaration – Electromagnetic Immunity**

The model POC-S198 is intended for use in the electromagnetic environment specified below. The customer or the user of the model POC-S198 should assure that it is used in such an environment.

Immunity test	IEC 60601 Test Level	Compliance Level	Electromagnetic Environmental Guidance
<p>Conducted RF IEC 61000-4-6</p> <p>Radiated RF IEC 61000-4-3</p>	<p>3 Vrms 150 kHz to 80 MHz</p> <p>3 V/m 80 MHz to 2,5 GHz</p>	<p>Vrms</p> <p>V/m</p>	<p>Portable and mobile RF communications equipment should be used no closer to any part of the model POC-S198, including cables, than the recommended separation distance calculated from the equation applicable to the frequency of the transmitter.</p> <p><b>Recommended Separation Distance</b></p> $d = 1,2 \sqrt{P}$ $d = 1,2 \sqrt{P} \text{ 80 MHz to 800 MHz}$ $d = 2,3 \sqrt{P} \text{ 800 MHz to 2,5 GHz}$ <p>where <math>P</math> is the maximum output power rating of the transmitter in watts (W) according to the transmitter manufacturer and <math>d</math> is the recommended separation distance in meters (m).</p> <p>Field strengths from fixed RF transmitters, as determined by an electromagnetic site survey, <sup>a</sup> should be less than the compliance level in each frequency range. <sup>b</sup></p> <p>Interference may occur in the vicinity of equipment marked with the following symbol:</p> 

NOTE 1 At 80 MHz and 800 MHz, the higher frequency range applies.

NOTE 2 These guidelines may not apply in all situations. Electromagnetic propagation is affected by absorption and reflection from structures, objects and people.



<sup>a</sup> Field strengths from fixed transmitters, such as base stations for radio (cellular/cordless) telephones and land mobile radios, amateur radio, AM and FM radio broadcast and TV broadcast cannot be predicted theoretically with accuracy. To assess the electromagnetic environment due to fixed RF transmitters, an electromagnetic site survey should be considered. If the measured field strength in the location in which the POC-S198 is used exceeds the applicable RF compliance level above, the POC-S198 should be observed to verify normal operation. If abnormal performance is observed, additional measures may be necessary, such as reorienting or relocating the unit.

<sup>b</sup> Over the frequency range 150 kHz to 80 MHz, field strengths should be less than 3 V/m.

---

# Chapter 3

## 3 Driver Installation



---

## 3.1 Introduction

The POC-S198 supports "one key" driver installation. User can just click one button to install all drivers.

**Warning!** *Please use clean OS to install this auto installation, otherwise, it might*



*cause un-expect error.*

## 3.2 Automatic Driver Installation

1. Double Click "InstallAll.exe" in D:\Driver\ folder. The Install dialog will appear.
2. Please follow the instruction to install the driver

# Chapter 4

## 4 Utilities and Hot Fixes

---

## 4.1 Introduction

The POC-S198 system needs specific utilities or hot fixes to support special functions.

## 4.2 Wakeup by External USB Device at S3 Resume (Wakeup)

POC-S198 supports three different sleep (suspend) modes; they are:

1. S1: Power On Suspend: system will stop the clock, turn off LCD backlight, but keep all power on. The user can press any key (by mouse or keyboard) to wake the system up.
2. S3: Suspend to RAM: system will stop the clock, turn off most power rails but not power to memory. It will save all necessary information to memory. In this sleep mode, Windows XP needs a hot fix to wake the system up via USB mouse or keyboard. Otherwise, only the power button can be used.
3. S4: Suspend to Disk (Hibernation): system will stop the clock, turn off most power, including power to memory. It will save all necessary information to hard disk. In this sleep mode, the user needs to press the power button to wake the system up.

### 4.2.1 Installation for Windows XP

This utility is an optional tool for Windows XP only. It needs to be installed only if the USB wakeup function is needed.

Please don't install it on WIN7 OS.

1. Double click the "USBRG.REG" in Driver CD:\Utility\USB folder
2. Click "Yes" to update the registry.
3. Click "OK" to close the successfully installation information window.

# Chapter 5

## 5 Operation and Safety Information

## 5.1 General Safety Guide

For your own safety and that of your equipment, always take the following precautions.

Disconnect the power plug (by pulling the plug, not the cord), from your computer if any of the following conditions exists:

- The power cord or plug becomes frayed or otherwise damaged
- You spill something into the case
- Your computer has been dropped or the case has been otherwise damaged
- You suspect that your computer needs service or repair
- You want to clean the computer or screen
- You want to remove/install any parts

## 5.2 Protecting Your Optical Drive

To keep your optical drive working properly:

- Position your computer so that the drive tray doesn't bump into anything when it opens.
- Close the drive when you're not using it.
- Do not put anything on the drive tray when it is open.
- Do not touch the optical drive lens with your fingers. Do not wipe the lens with a paper towel or other abrasive surface.

## 5.3 Thermal

The vent hole of the POC-S198 rear cover functions as a cooling air flow inlet and outlet. These air inlets and outlets transfer heat from inside the computer to the cooler air outside. Do not block these holes/vents with any soft material.

When using your POC-S198 system, it is normal for the rear metal heatsink to get warm. The rear metal heatsink of the POC-S198 functions as a cooling surface that transfers heat from inside the computer to the cooler air outside. Do not block this heatsink with any soft material.

**Warning!** *Do not place your POC-S198 system on a pillow or other soft material when it is on, as the material may block the airflow and cause the computer to overheat.*



## 5.4 Disconnect the Power

The only way to disconnect power completely is to unplug the adapter power cord. Make sure at least one end of the power cord is within easy reach so that you can unplug the computer when you need to.

**Warning!** *Your AC cord came equipped with a three-wire grounding plug (a plug that has a third grounding pin). This plug will fit only a grounded AC outlet. If you are unable to insert the plug into an outlet because the outlet is not grounded, contact a licensed electrician to replace the outlet with a properly grounded outlet. Do not defeat the purpose of the grounding plug.*





**Warning!** *Never push objects of any kind into this product through the openings in the case. Doing so may be dangerous and result in fire or a dangerous electric shock.*



*Never place anything on system case before turning off the computer.*

*Never turn on your computer unless all of its internal and external parts are in place.*

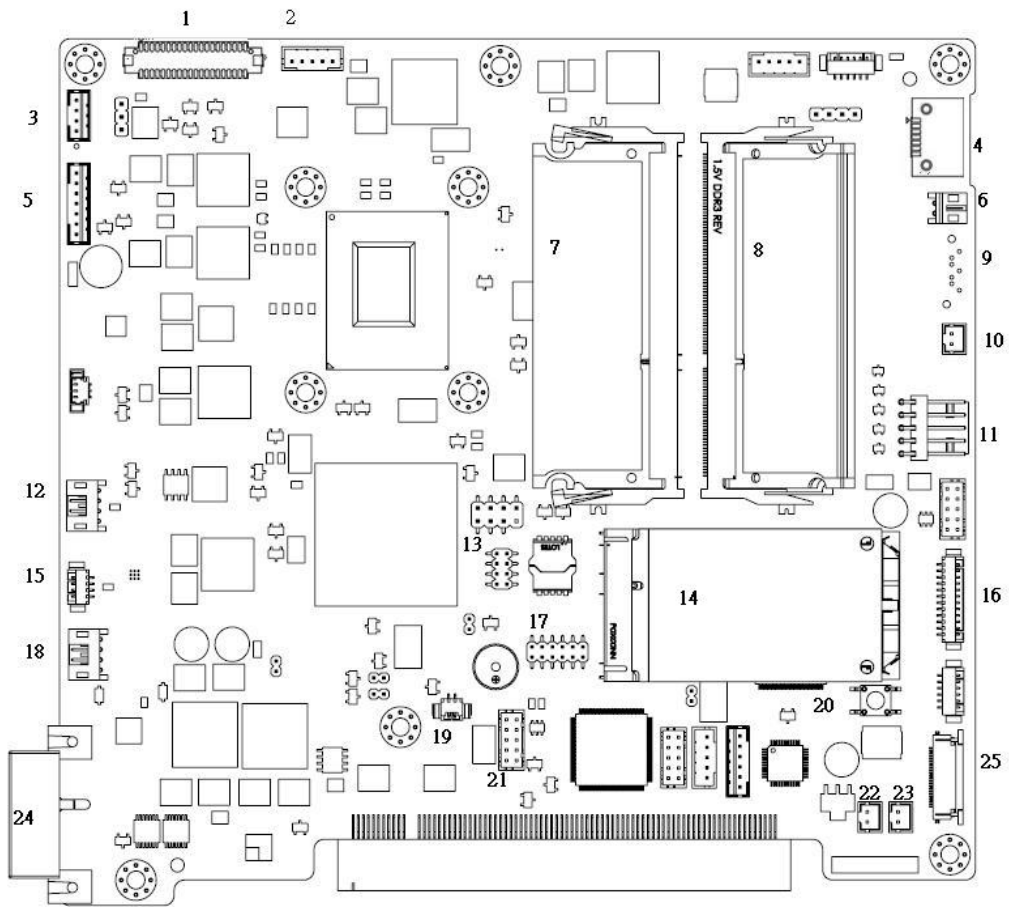
*Operating the computer when it is open or missing parts can be dangerous and can damage your computer.*

# Chapter 6

## 6 PCM-8713 Connector Map and Table



## 6.1 Motherboard Top Side



## 6.2 Motherboard Bottom Side

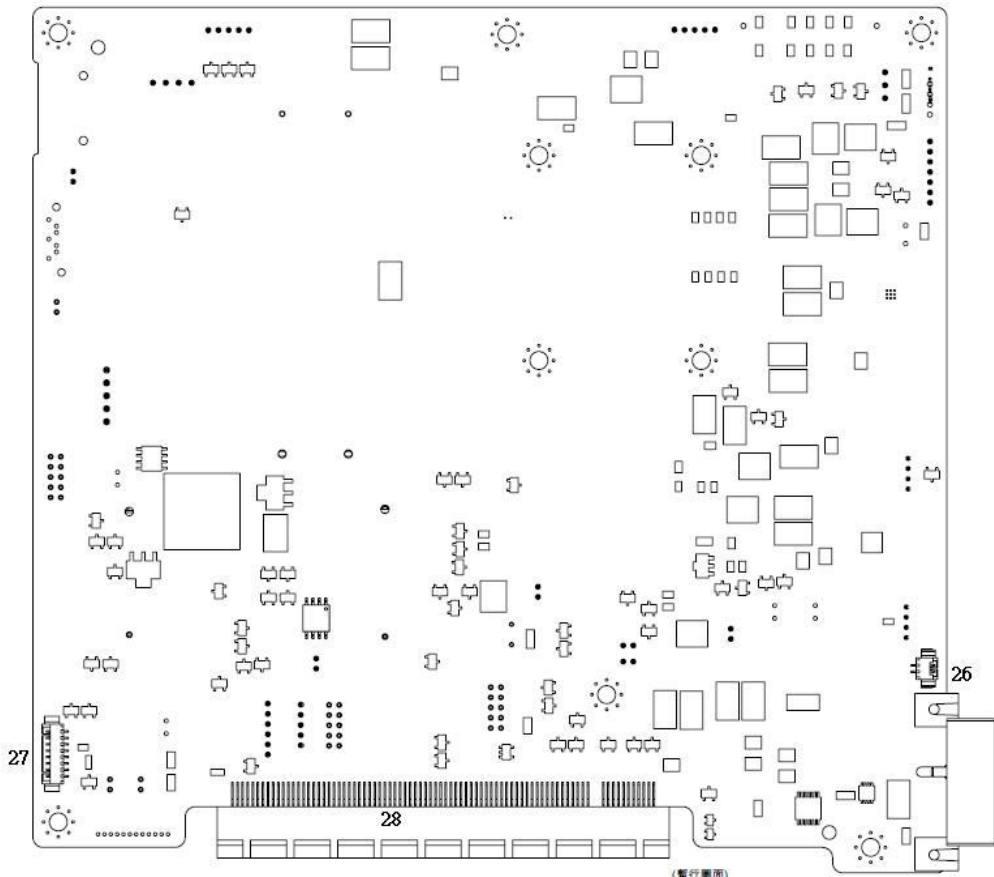
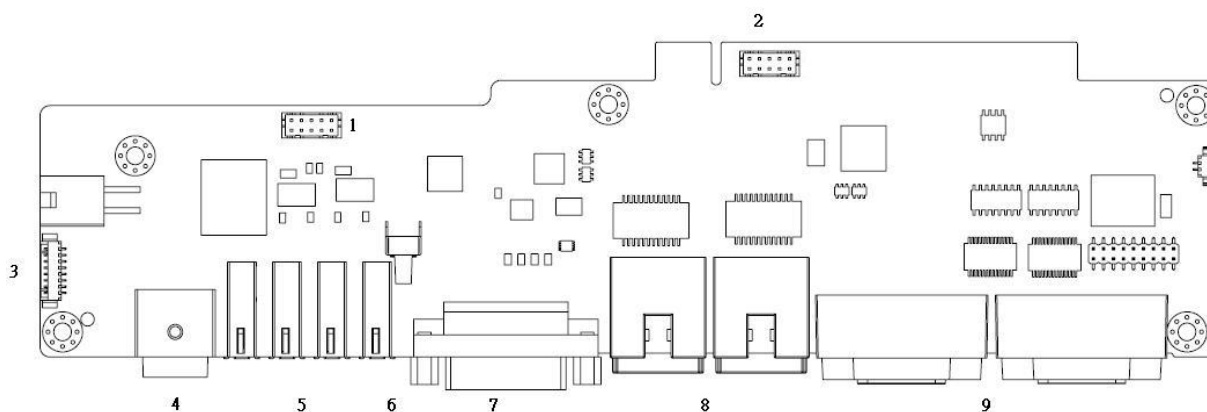


Table 6.1: MB Connector Table

No.	Description
1	LVDS Connector
2	EC SMBUS Connector
3	FAN (Reserved)
4	SATA 0 Connector
5	LED Driver/Inverter Connector
6	SATA 0 Power Connector
7	DDR3 SODIMM A Socket
8	DDR3 SODIMM B Socket
9	SATA 1 Connector
10	SATA 1 Power Connector
11	5-Wire Resistive Touch Connector
12	USB (Reserved)
13	BIOS Flash Port (Reserved)
14	Mini PCIe Socket
15	RFID Connector
16	Front Button Board Connector
17	Port 80 Debug Port
18	Smart Card Connector
19	RTC Battery Connector
20	Power Button (Reserved)
21	USB (Reserved)
22	Right Speaker Connector
23	Left Speaker Connector
24	PCIex1 Slot
25	EC Debug Port (Reserved)
26	12V (Reserved)
27	Bluetooth Connector
28	I/O Board Slot

## 6.3 I/O Board

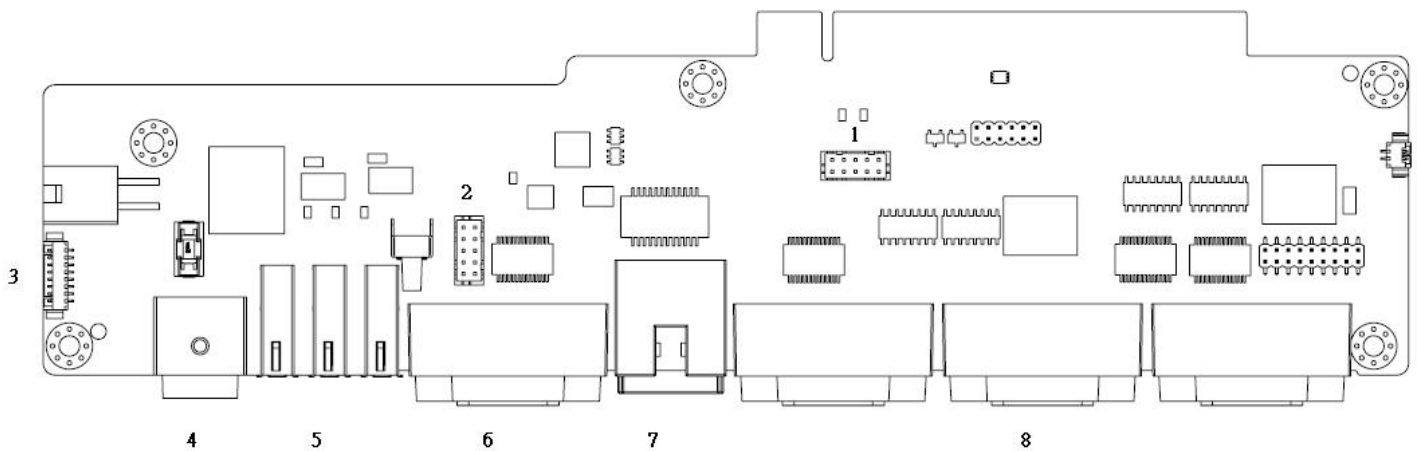
2COM



**Table 6.2: I/O Connector Table**

No.	Description
1	USB Connector (Reserved)
2	USB Connector
3	Internal Backup Battery Connector
4	DCIN
5	USB I/O x4
6	VGA
7	HDMI
8	LAN (iAMT) x2
9	COM x2

4COM



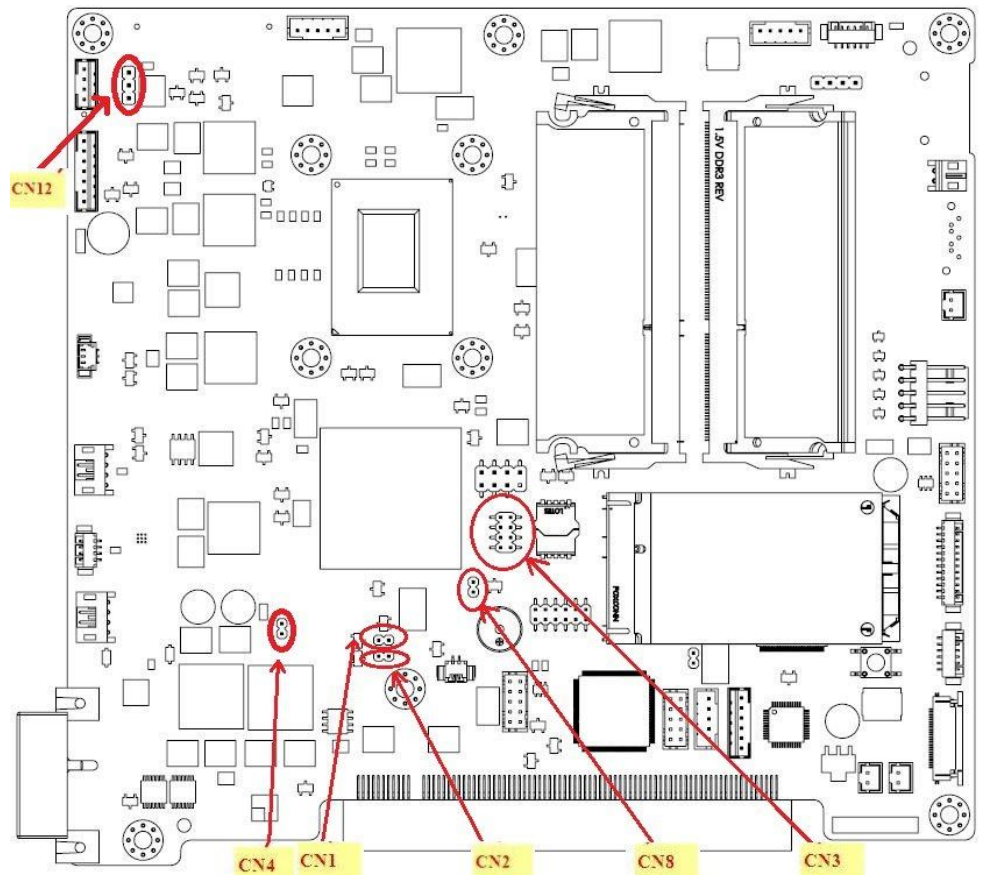
**Table 6.2: I/O Connector Table**

No.	Description
1.	USB Connector (Reserved)
2.	USB Connector
3.	Internal Backup Battery Connector
4.	DC IN
5.	USB I/O x3
6.	COM
7.	LAN (iAMT) x2
8.	COM x3

# Chapter 7

## PCM-8713 Jumper Settings

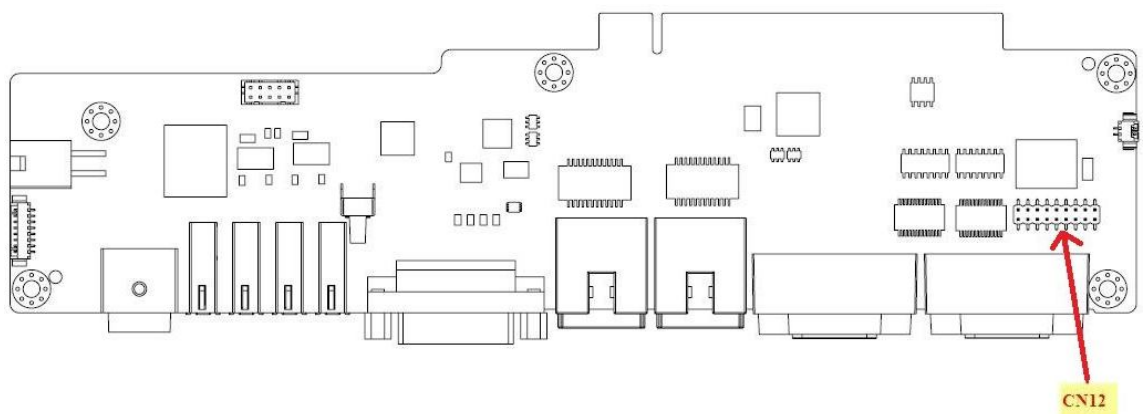
## 7.1 Motherboard



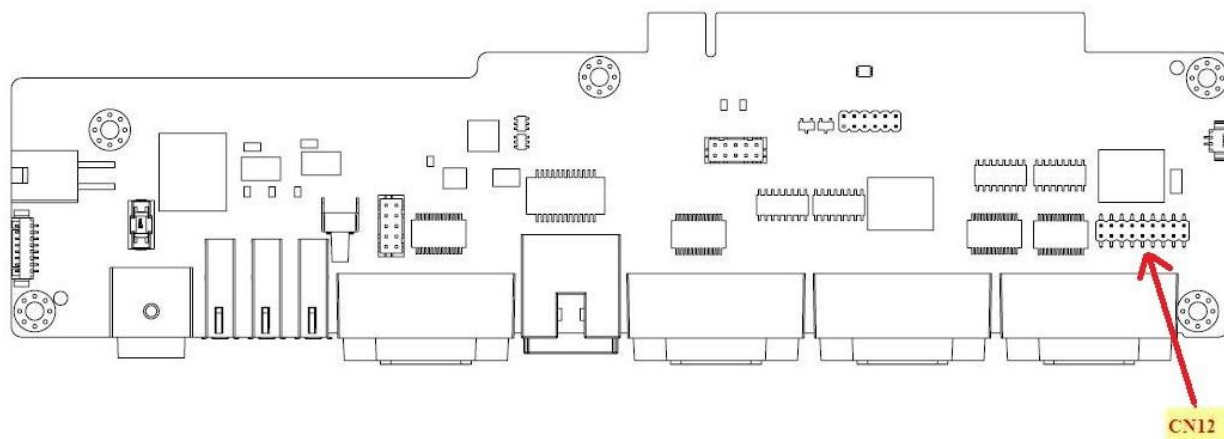
\* All Jumpers located at top side

**Figure 7.1 PCM-8713  
Motherboard Top Side**

## 7.2 I/O Board







\* All Jumpers located at top side

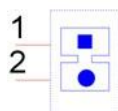
**Figure 7.2 PCM-8713 I/O Top Side**

**Table 7.1: Jumper Settings:**

Setting	Function
CN1	Clear CMOS
CN2	Clear ME
CN3	VBIOS Setup
CN4	ME Manufacturing Mode
CN8	System Reset
CN12	LVDS Voltage Select
<b>IO:</b>	
CN12	COM1 RS-232/422/485 output type setting

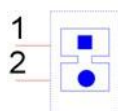
**Table 7.2: CN: Clear CMOS**

Setting	Function
(1-2)	Clear CMOS Setup
(No Connect)	Normal Operation (Default)



**Table 7.3: CN2: Clear ME**

Setting	Function
(1-2)	Clear ME Setup
(No Connect)	Normal Operation (Default)



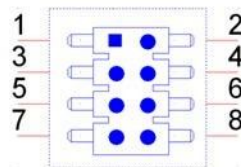
C

**Table 7.4: CN3: VBIOS Setup**

Setting	Function
(3-4)(5-6)	Panel Resolution: 24-bit single channel 1024x768
(1-2)(5-6)	Panel Resolution: 24-bit dual channel 1280x1024
(1-2)(3-4)(5-6)	Panel Resolution: 24-bit dual channel 1680x1050
(5-6)	Panel Resolution: Manual setting
(3-4)	Panel Resolution: 24-bit dual channel 1920x1080 (Default)
(1-2)	Panel Resolution: 24-bit single channel 1366x768
(1-2)(3-4)	Reserved
(No Connect)	Reserved

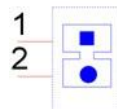
**Table 7.5: CN3: Select Boot Main Display Setup**

Setting	Function
(7-8)	Set VGA as main display at bootup
(No Connect)	Set LVDS as main display at bootup (Default)



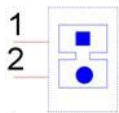
**Table 7.6: CN4: ME Manufacturing Mode**

Setting	Function
(1-2)	ME Manufacturing Mode
(No Connect)	Normal Operation (Default)



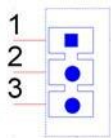
**Table 7.7: CN8: System Reset**

Setting	Function
(1-2)	System Reset
(No Connect)	Normal Operation (Default)



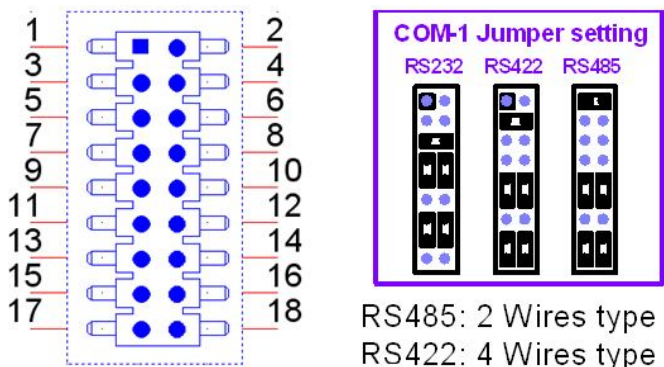
**Table 7.8: CN12 (MB): LVDS Voltage Select**

Setting	Function
(1-2)	LVDS Power use 5V (Default)
(2-3)	LVDS Power use 3.3V



**Table 7.9: CN12 (IO): COM1 RS-232/422/485 Output Type Settings**

Setting	Function
(5-6), (7-9), (8-10), (13-15), (14-16)	RS-232 (Default)
(3-4), (9-11)(10-12), (15-17)(16-18)	RS-422
(1-2), (9-11)(10-12), (15-17)(16-18)	RS-485



---

#### RS-485 BIOS Setting

1. Press F2 or Del key on your keyboard immediately after power on the computer
2. BIOS menu → Advanced → Super IO Configuration → Serial Port 0 Configuration → RS485 auto flow control → Enabled
3. Press F4 to Save and Exit

# Chapter 8

## 8 Front Bezel Button








## 8.1 Introduction

This section outlines the POC-S198 front button function descriptions.

### 8.1.1 Front Button Map



#### Button Description:

Power button 	Press this button to power on/off system. When system ON, this icon will become green. The LED will turn off when system is off.
Reduce volume 	Press this button to reduce speaker and headphone volume.
Increase volume 	Press this button to increase speaker and headphone volume.
Touch disable 	Press this button to disable/enable touch function. When touch function is enabled, this icon will become green. When touch function is disabled, this LED will be off.
Read light 	Press this button to enable/disable read light.
Reduce brightness 	Press this button to reduce LCD backlight brightness.
Increase brightness 	Press this button to increase LCD backlight brightness.

#### Combination Button:

The backlight off function is a special function. When you press both the reduce brightness and increase brightness buttons at the same time for half a second, the LCD backlight will turn off. Pressing both buttons again for a half second will turn on the LCD backlight.

When the backlight is off, the POC-S198 system will still run. There will not be an impact to any operating programs.

This backlight off function can be used in a hospital environment.

If an operator needs to check X-rays in a dark room environment, the operator can quickly turn off the backlight to prevent interference.

An operator can turn off the backlight at night to prevent disturbing a sleeping patient.

# Chapter 9

## 9 POC-S198 Advanced BIOS Function

## 9.1 Introduction

This section introduces the advanced functions of the POC-S198 BIOS menu.

### 1. Power Button Function Enable/Disable

You can enable/disable power button functions from the BIOS menu.

If you disable the power button in S0 (System ON) status, the power button will not work. This prevents a user from turning a system off by the power button, preventing accidental shutdown of the system. In this mode software is required to turn off the system.

BIOS Menu location:

BIOS Menu - Advanced - Embedded Controller Configuration - Power Button Function

Enable: Power button function works when system in S0 (System ON) status. (Default)

Disable: Power button function does not work when system in S0 (System ON) status.

Press power button 5 seconds or more to trigger power button.

### 2. Brightness Button Control

You can enable/disable LCD Backlight button function in BIOS menu.

If you disable the LCD Backlight button, this button will not work, preventing a user from adjusting LCD backlight luminance. This function can prevent accidentally touching the LCD backlight button and inadvertently adjusting LCD backlight luminance.

BIOS Menu location:

BIOS Menu - Advanced - Embedded Controller Configuration - Brightness Button Control

Enable: Front bezel LCD Backlight adjust button control functions work. (Default)

Disable: Front bezel LCD Backlight adjust button control functions do not work.

### 3. Volume Button Control

You can enable/disable Front Volume button functions in BIOS menu.

If you disable the Front Volume button, this button will not work, preventing a user from adjusting speaker volume. This function can prevent accidental volume adjustments.

BIOS Menu location:

BIOS Menu - Advanced - Embedded Controller Configuration - Volume Button Control

Enable: Front bezel volume adjust button control functions work. (Default)

Disable: Front bezel volume adjust button control functions do not work.



#### 4. EC Beep Function

You can enable/disable EC beep function in BIOS menu.

If you disable the EC beep function, EC will not generate a beeping sound when you press front bezel button.

BIOS Menu location:

BIOS Menu - Advanced - Embedded Controller Configuration - EC Beep Function

Enable: Beeping sound when front bezel button pressed. (Default)

Disable: No beeping sound when front bezel button pressed.

#### 5. Setup Popup Menu F12

You can enable/disable F12 key Setup popup menu in BIOS menu.

When you press F12 key in bootup, BIOS will display a bootable device menu and you can select the proper boot device that you want.

BIOS Menu location:

BIOS Menu - Boot - Setup Popup Menu F12

Enable: Press F12 key at bootup displays popup menu (Default)

Disable: Press F12 key at bootup does not display popup menu



# Appendix **A**

**POC-S198 VESA  
Mounting**

## A.1 Install VESA Mounting

The POC-S198 also provides standard VESA mounting to help system integrators conveniently integrate the panel PC into their system.

Never use mounting brackets except as provided by Advantech to prevent unreliable mounting of the POC-S198. VESA mount installation should be carried out by a professional technician; please contact a service technician or your retailer if you need this service.

Installation instructions follow:

1. First attach wall-mounting to the heat-sink of the POC-S198, securing it in place with the four Phillips-head screws provided.
2. Mount the unit on the wall, stand or other flat surface.

**Warning!** *Be sure to secure the screws of the mounting bracket tightly. A loose joint between the POC-S198 and mounting bracket may create danger of injury.*

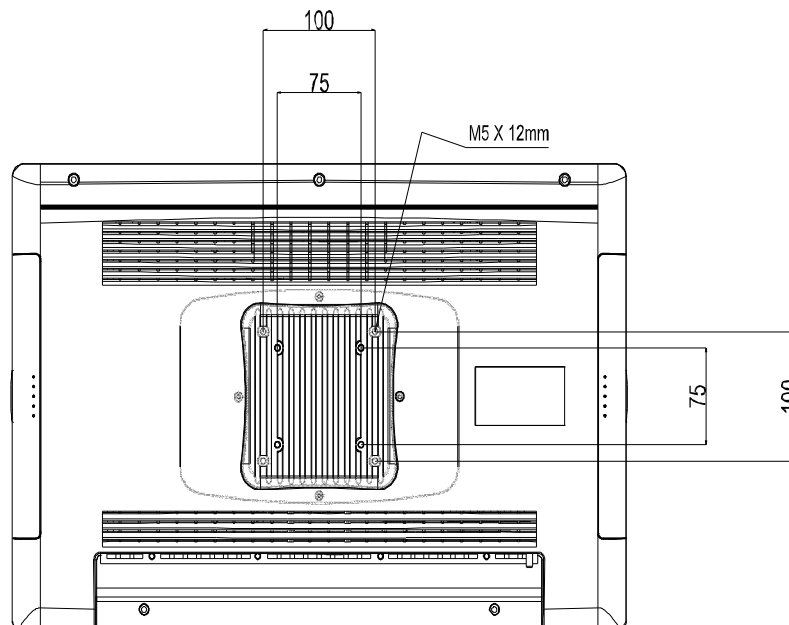


Figure A.1 VESA Mounting 75x75mm, 100x100 mm



**ADVANTECH**

*Enabling an Intelligent Planet*

**[www.advantech.com](http://www.advantech.com)**

Please verify specifications before quoting. This guide is intended for reference purposes only.

All product specifications are subject to change without notice.

No part of this publication may be reproduced in any form or by any means, electronic, photocopying, recording or otherwise, without prior written permission of the publisher.

All brand and product names are trademarks or registered trademarks of their respective companies.

© Advantech Co., Ltd. 2012