

| PLUG P/N   | CKT | DIM "A" | DIM "B" |
|------------|-----|---------|---------|
| 1727621002 | 2   | 5.40    | 4.95    |
| 1727621004 | 4   | 9.60    | 4.95    |
| 1727621006 | 6   | 13.80   | 4.95    |
| 1727621008 | 8   | 18.00   | 4.95    |
| 1727621010 | 10  | 22.20   | 12.95   |
| 1727621012 | 12  | 26.40   | 12.95   |
| 1727621014 | 14  | 30.60   | 12.95   |
| 1727621016 | 16  | 34.80   | 12.95   |
| 1727621018 | 18  | 39.00   | 20.95   |

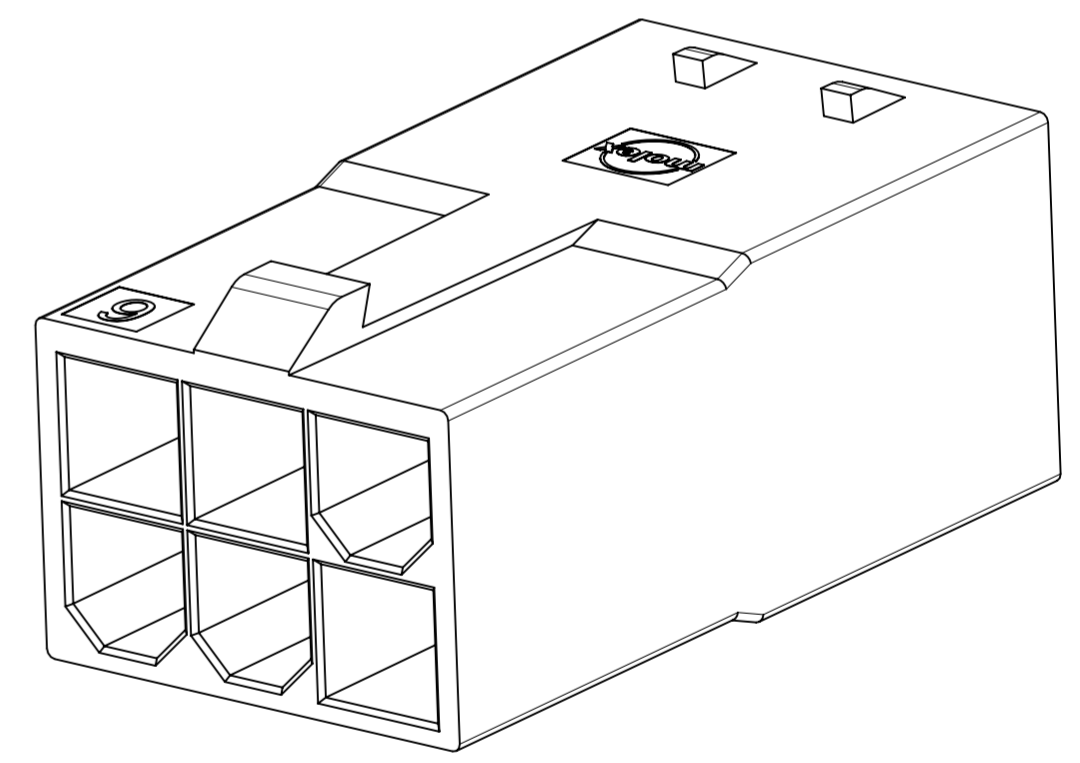
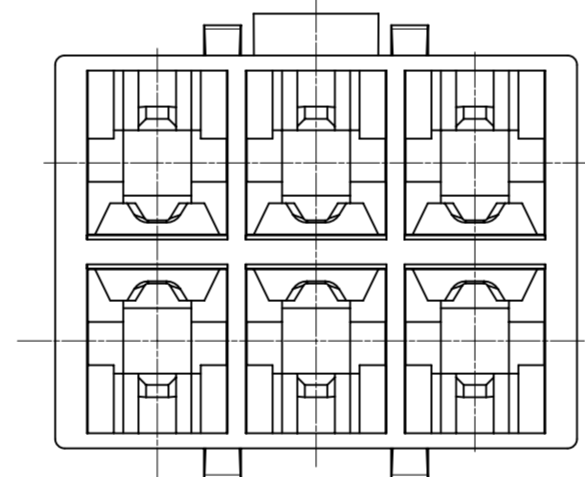
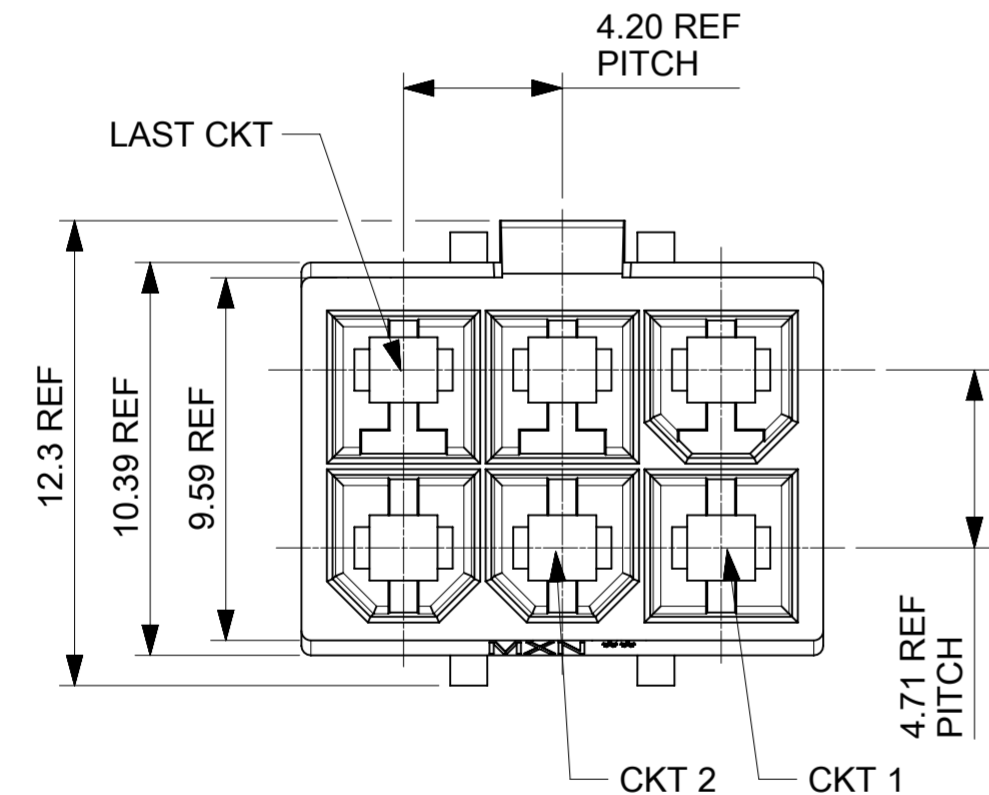

- NOTES:
1. MATERIAL: NYLON, UL 94V-0 AND GLOW WIRE CAPABLE PER IEC60335-1; COLOR: BLACK
  2. FINISH: NONE
  3. PRODUCT SPECIFICATION: 2131370000-PS/2029880002-PS  
APPLICATION SPECIFICATION: 2131370000-AS
  4. PACKAGING SPECIFICATION: 172762-0001-PK  
REFER TO AS-45499-001 FOR MOISTURIZING NYLON CONNECTOR PARTS.
  5. THIS PART TO BE USED WITH FEMALE TERMINAL SERIES 172765, 203070 AND TPA SERIES 172709-2\*\*\*.
  6. THIS PART MATES WITH RECEPTACLE SERIES 172708-1\*\*\*
  7. THIS PART CONFORMS TO CLASS 'B' REQUIREMENTS OF COSMETIC SPECIFICATION PS-45499-002.
  8. SEE DRAWING 1727090002-SD FOR OTHER TPA INFORMATION.
  9. SEE DRAWING 1727080002-SD FOR RECEPTACLE INFORMATION.
  10. SEE DRAWINGS SD-172718-0000 AND 2029880001-PSD FOR OTHER CRIMP TERMINAL INFORMATION.

| THIS DRAWING CONTAINS INFORMATION THAT IS PROPRIETARY TO MOLEX ELECTRONIC TECHNOLOGIES, LLC AND SHOULD NOT BE USED WITHOUT WRITTEN PERMISSION |        |                        |  |                  |  |   |  |  |  |
|---|--------|------------------------|--|------------------|--|---|--|--|--|
| DIMENSION UNITS   | SCALE  | CURRENT REV DESC:      |  |                  |  | <b>molex</b>  |  |  |  |
| mm  | NTS    |                        |  |                  |  |   |  |  |  |
| GENERAL TOLERANCES (UNLESS SPECIFIED)   |        |                        |  |                  |  | SD-DRAWING OF MINI-FIT SIGMA DR PLUG  |  |  |  |
| ANGULAR TOL   | ± °    |                        |  |                  |  |   |  |  |  |
| 4 PLACES  | ±      | EC NO: 735375          |  | 2023/01/06       |  | PRODUCT CUSTOMER DRAWING  |  |  |  |
| 3 PLACES  | ±      | DRWN: JERRYW8          |  | 2023/02/01       |  |   |  |  |  |
| 2 PLACES  | ± 0.25 | CHK'D: XQZHANG         |  | 2023/02/01       |  | DOCUMENT NUMBER: 1727620001-SD   DOC TYPE: PSD   DOC PART: 000   REVISION: A5 |  |  |  |
| 1 PLACE   | ± 0.36 | APPR: XQZHANG          |  | 2023/02/01       |  |   |  |  |  |
| 0 PLACES  | ±      | INITIAL REVISION:      |  | 2019/09/18       |  | MATERIAL NUMBER: SEE TABLE   CUSTOMER: GENERAL MARKET   SHEET NUMBER: 1 OF 4  |  |  |  |
| DRAFT WHERE APPLICABLE MUST REMAIN WITHIN DIMENSIONS  |        | DRWN: ALU002           |  | 2019/10/11       |  |   |  |  |  |
|   |        | APPR: YXZHENG          |  | 2019/10/11       |  |   |  |  |  |
|   |        | THIRD ANGLE PROJECTION |  | DRAWING: A2-SIZE |  | SERIES: 172762  |  |  |  |

| DOCUMENT STATUS | P1 | RELEASE DATE | 2023/02/01 | 07:45:18 |
|-----------------|----|--------------|------------|----------|
|                 |    |              |            |          |

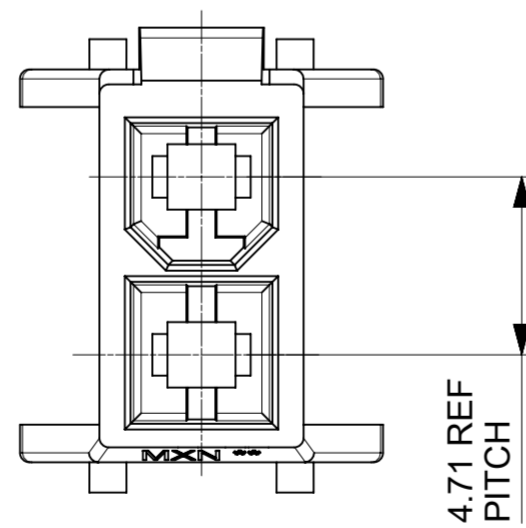
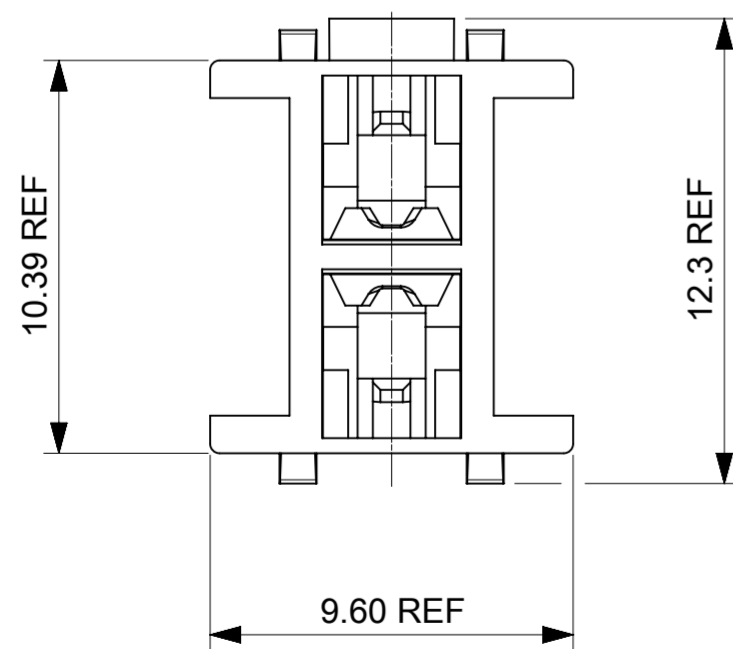
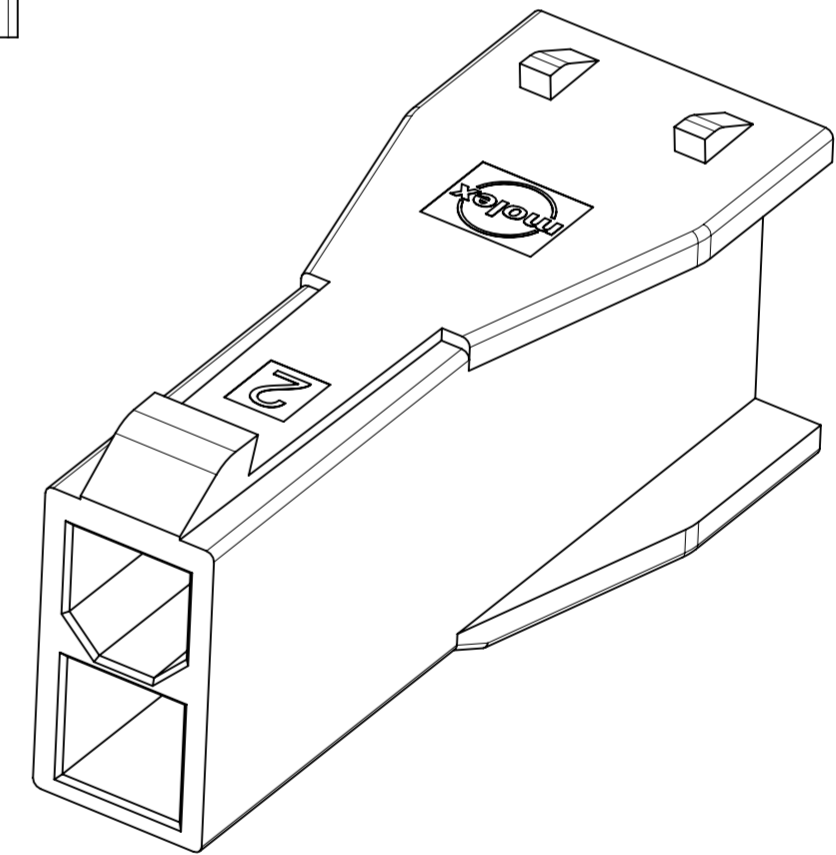
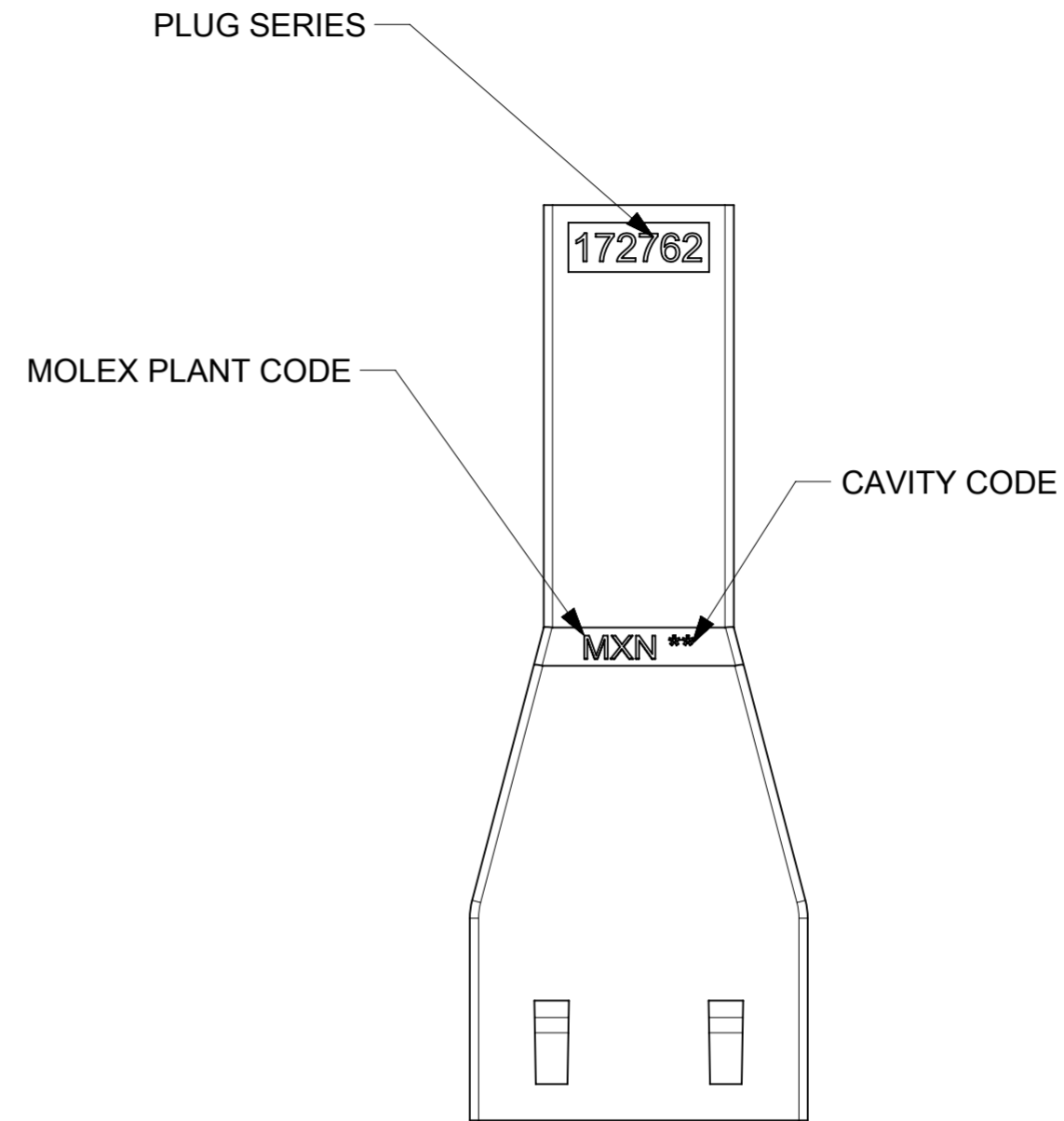
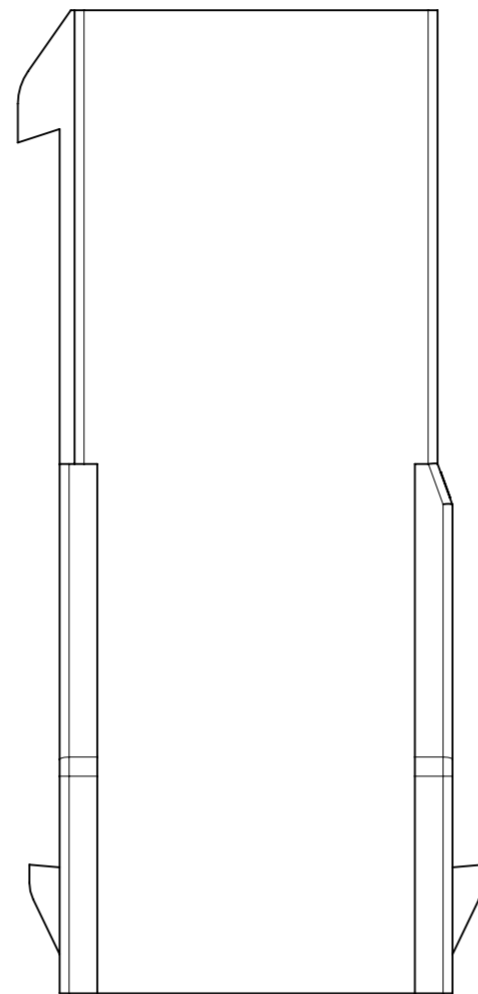
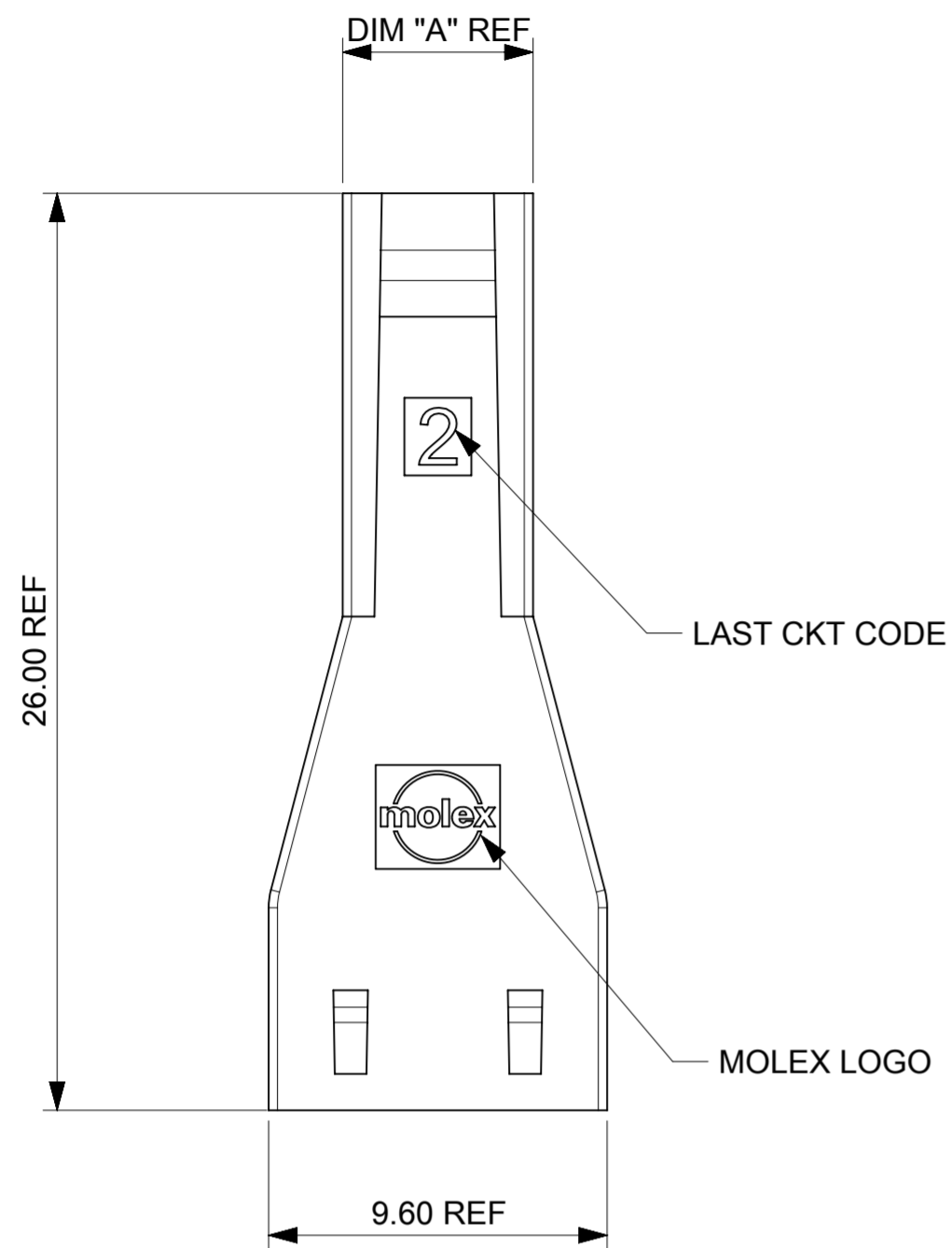

|   |  |        |  |                        |  |                |  |                                      |  |
|---|--|--------|--|------------------------|--|----------------|--|--------------------------------------|--|
| THIS DRAWING CONTAINS INFORMATION THAT IS PROPRIETARY TO MOLEX ELECTRONIC TECHNOLOGIES, LLC AND SHOULD NOT BE USED WITHOUT WRITTEN PERMISSION |  |        |  |                        |  |                |  |                                      |  |
| DIMENSION UNITS   |  | SCALE  |  | CURRENT REV DESC:      |  |                |  | <b>molex</b>                         |  |
| mm  |  | NTS    |  |                        |  |                |  |                                      |  |
| GENERAL TOLERANCES (UNLESS SPECIFIED)   |  |        |  |                        |  |                |  | SD-DRAWING OF MINI-FIT SIGMA DR PLUG |  |
| ANGULAR TOL   |  | ± °    |  |                        |  |                |  | PRODUCT CUSTOMER DRAWING             |  |
| 4 PLACES  |  | ±      |  | EC NO: 735375          |  | 2023/01/06     |  | DOCUMENT NUMBER                      |  |
| 3 PLACES  |  | ±      |  | DRWN: JERRYW8          |  | 2023/02/01     |  |                                      |  |
| 2 PLACES  |  | ± 0.25 |  | CHK'D: XQZHANG         |  | 2023/02/01     |  |                                      |  |
| 1 PLACE   |  | ± 0.36 |  | INITIAL REVISION:      |  |                |  | 1727620001-SD                        |  |
| 0 PLACES  |  | ±      |  | DRWN: ALUO02           |  | 2019/09/18     |  |                                      |  |
| DRAFT WHERE APPLICABLE MUST REMAIN WITHIN DIMENSIONS  |  |        |  | THIRD ANGLE PROJECTION |  | DRAWING        |  | SERIES                               |  |
|   |  |        |  |                        |  | A2-SIZE        |  | 172762                               |  |
|   |  |        |  | MATERIAL NUMBER        |  | CUSTOMER       |  | SHEET NUMBER                         |  |
|   |  |        |  | SEE TABLE              |  | GENERAL MARKET |  | 2 OF 4                               |  |

|                 |    |              |            |          |
|-----------------|----|--------------|------------|----------|
| DOCUMENT STATUS | P1 | RELEASE DATE | 2023/02/01 | 07:45:18 |
|-----------------|----|--------------|------------|----------|

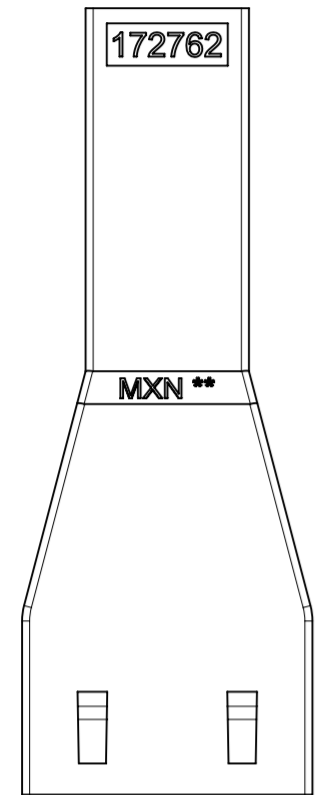
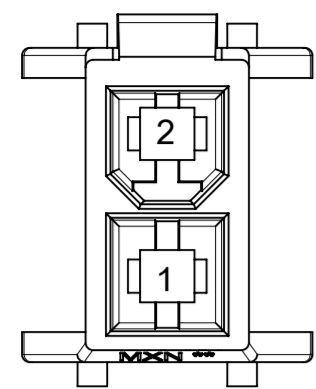

2-CKT

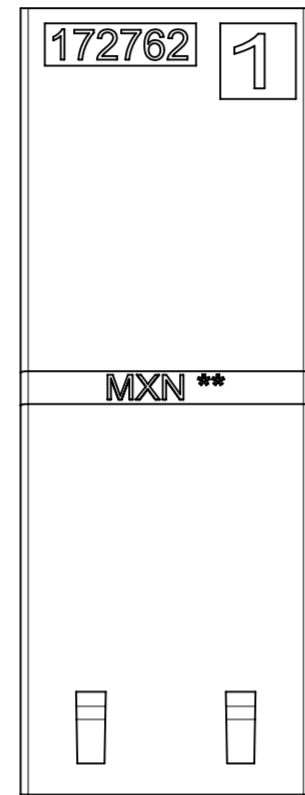
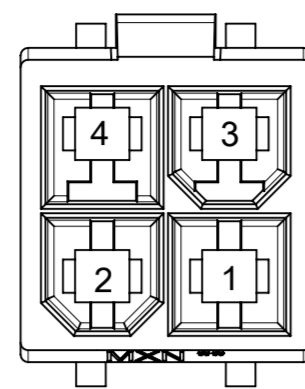

4-CKT

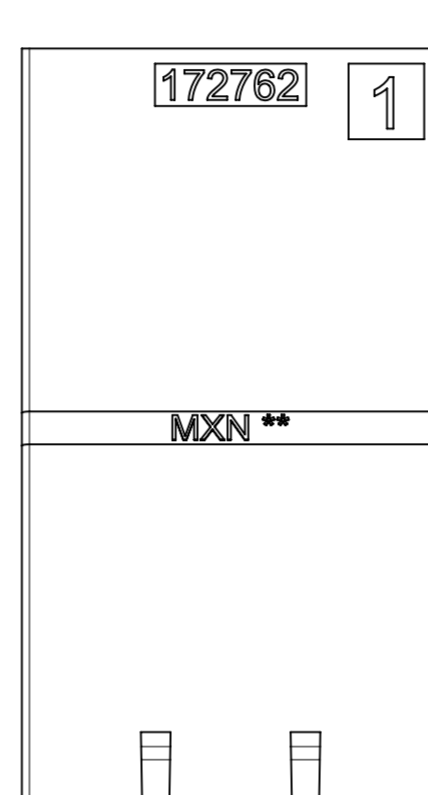
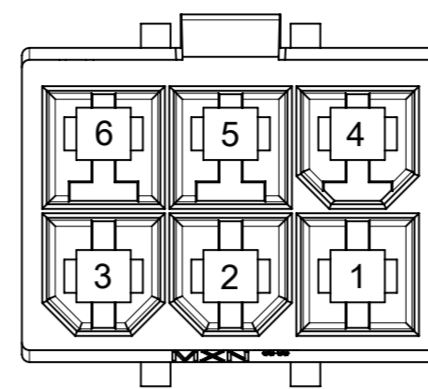

6-CKT

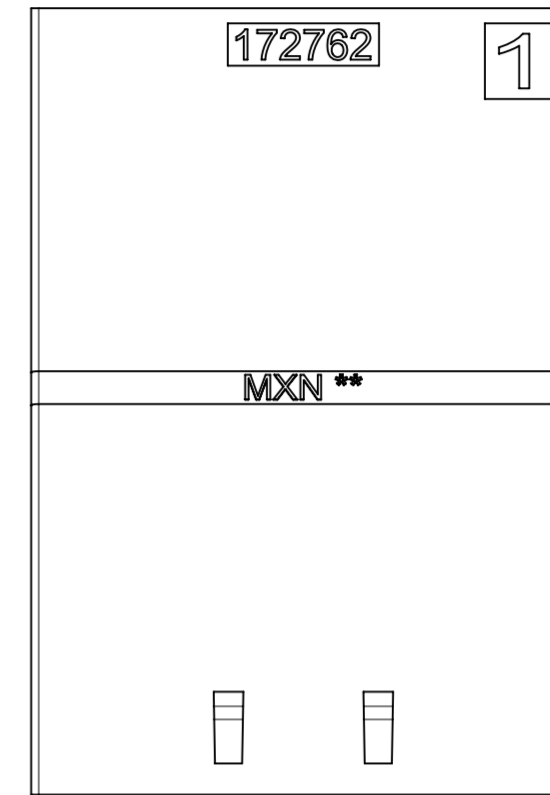
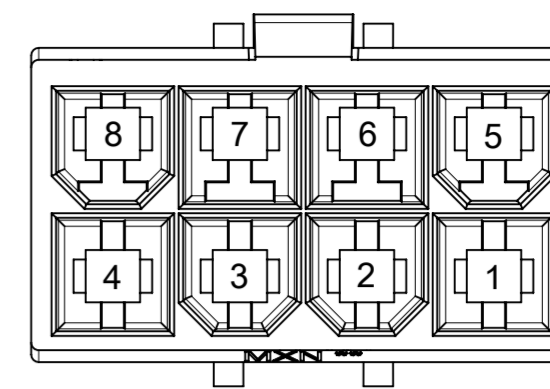

8-CKT

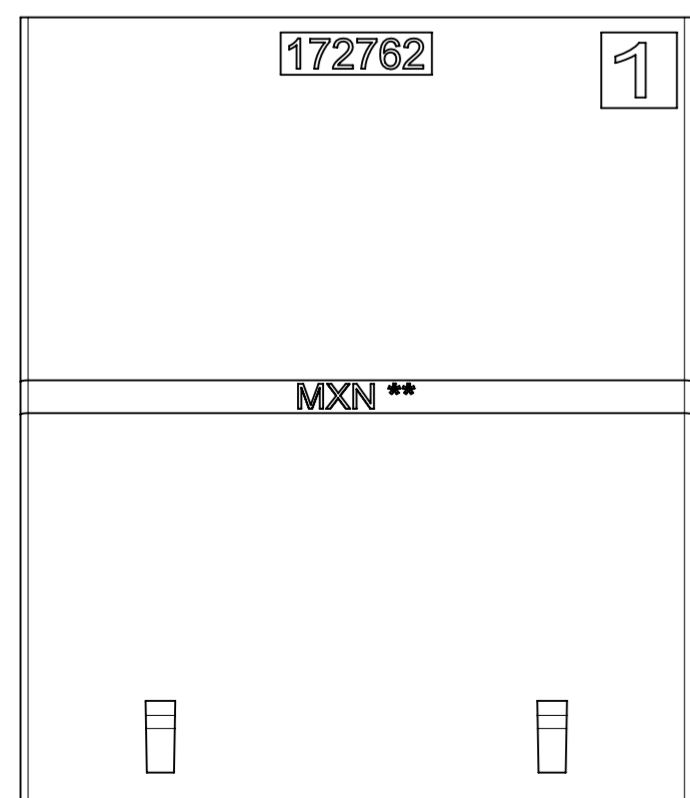
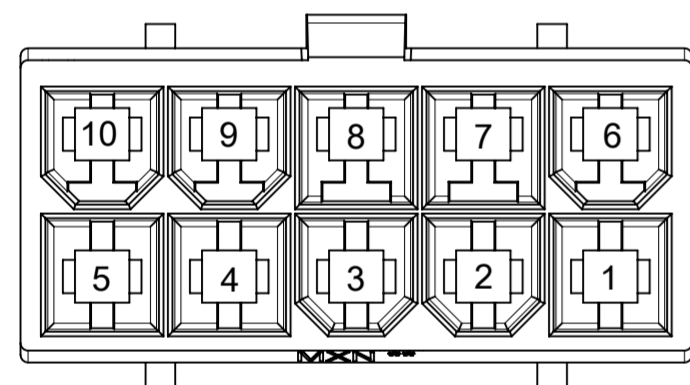

10-CKT

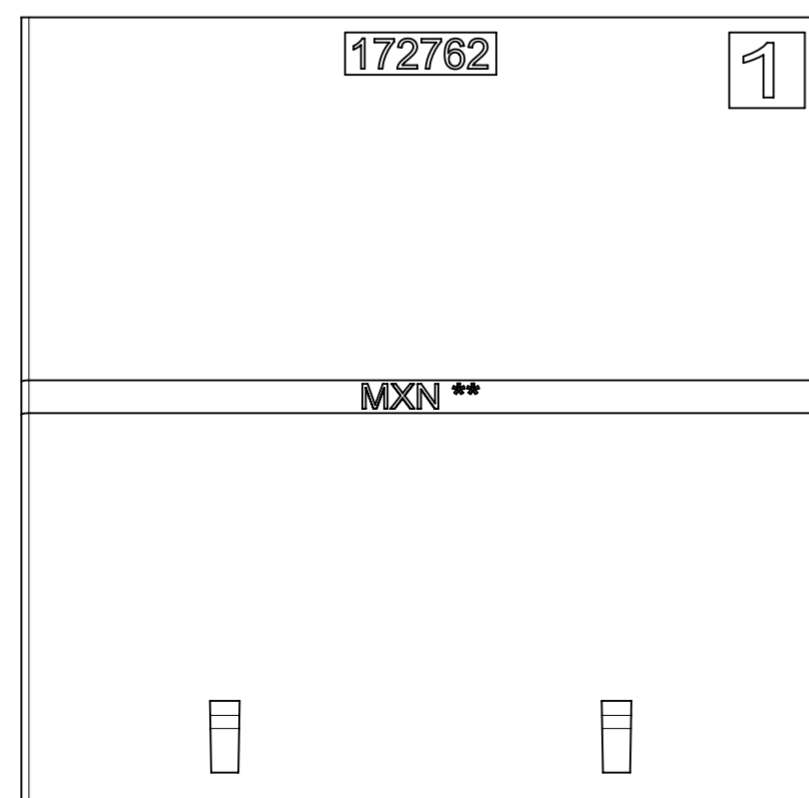
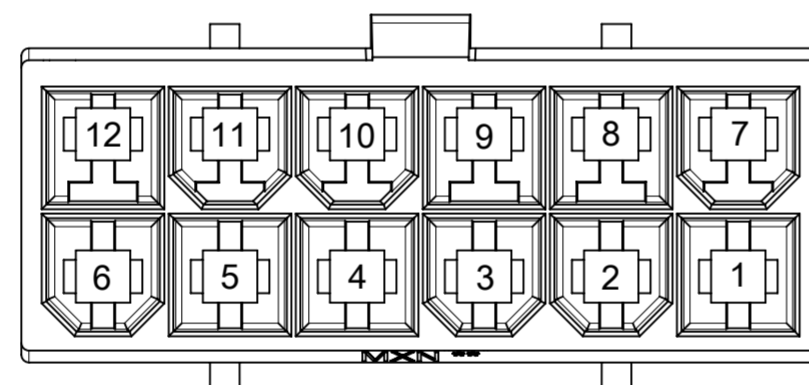

12-CKT

|   |  |                        |  |                           |  |          |  |                                      |  |
|---|--|------------------------|--|---------------------------|--|----------|--|--------------------------------------|--|
| THIS DRAWING CONTAINS INFORMATION THAT IS PROPRIETARY TO MOLEX ELECTRONIC TECHNOLOGIES, LLC AND SHOULD NOT BE USED WITHOUT WRITTEN PERMISSION |  |                        |  |                           |  |          |  |                                      |  |
| DIMENSION UNITS   |  | SCALE                  |  | CURRENT REV DESC:         |  |          |  |                                      |  |
| mm  |  | NTS                    |  |                           |  |          |  |                                      |  |
| GENERAL TOLERANCES (UNLESS SPECIFIED)   |  |                        |  | EC NO: 735375             |  |          |  | SD-DRAWING OF MINI-FIT SIGMA DR PLUG |  |
| ANGULAR TOL ± °   |  |                        |  | DRWN: JERRYW8 2023/01/06  |  |          |  |                                      |  |
| 4 PLACES ±  |  |                        |  | CHK'D: XQZHANG 2023/02/01 |  |          |  | PRODUCT CUSTOMER DRAWING             |  |
| 3 PLACES ±  |  |                        |  | APPR: XQZHANG 2023/02/01  |  |          |  |                                      |  |
| 2 PLACES ± 0.25   |  |                        |  | INITIAL REVISION:         |  |          |  | DOCUMENT NUMBER                      |  |
| 1 PLACE ± 0.36  |  |                        |  | DRWN: ALUO02 2019/09/18   |  |          |  |                                      |  |
| 0 PLACES ±  |  |                        |  | APPR: YXZHENG 2019/10/11  |  |          |  | 1727620001-SD                        |  |
| DRAFT WHERE APPLICABLE MUST REMAIN WITHIN DIMENSIONS  |  | THIRD ANGLE PROJECTION |  | DRAWING                   |  | SERIES   |  | MATERIAL NUMBER                      |  |
|   |  |                        |  | A2-SIZE                   |  | 172762   |  | SEE TABLE                            |  |
|   |  |                        |  | GENERAL MARKET            |  | CUSTOMER |  | SHEET NUMBER                         |  |
|   |  |                        |  |                           |  |          |  | 3 OF 4                               |  |

|                 |    |              |            |          |
|-----------------|----|--------------|------------|----------|
| DOCUMENT STATUS | P1 | RELEASE DATE | 2023/02/01 | 07:45:18 |
|-----------------|----|--------------|------------|----------|

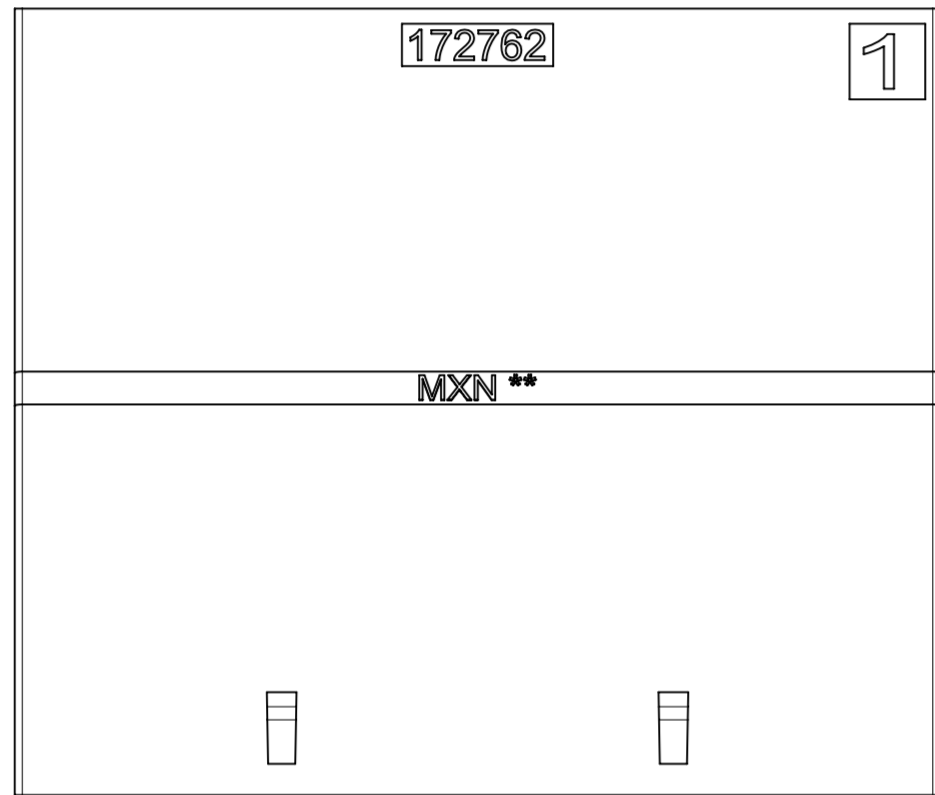
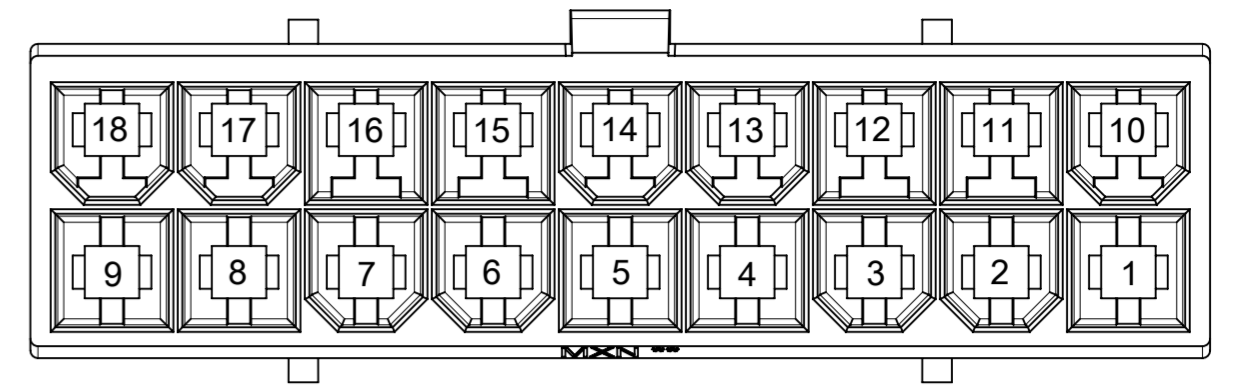
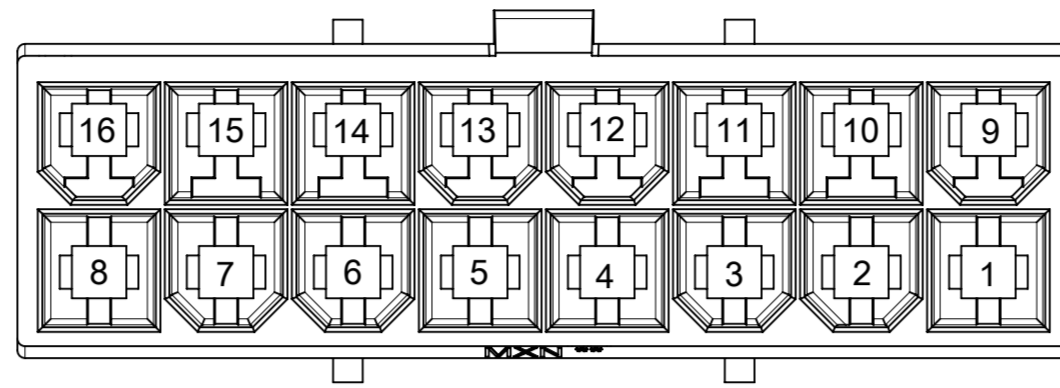
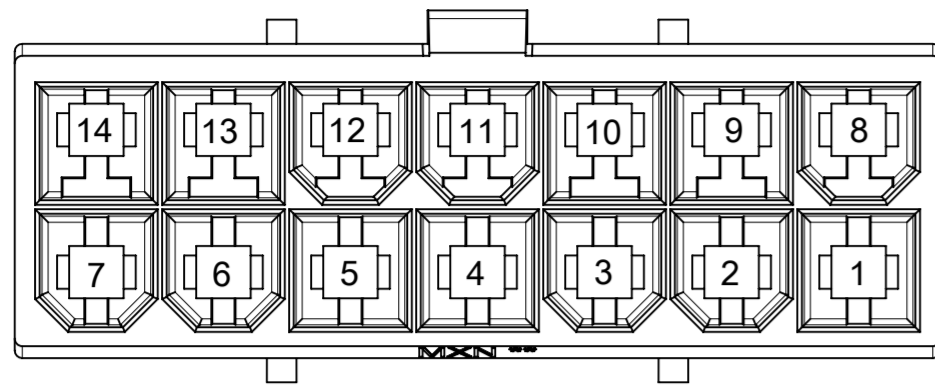

14-CKT

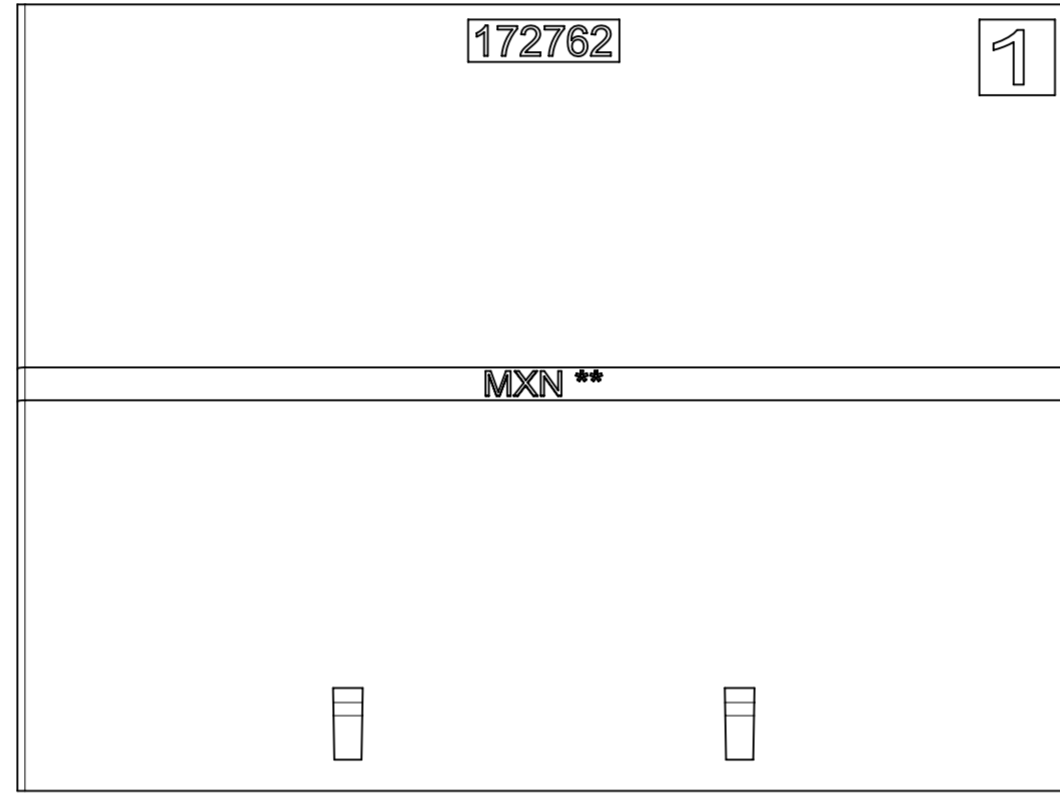

16-CKT

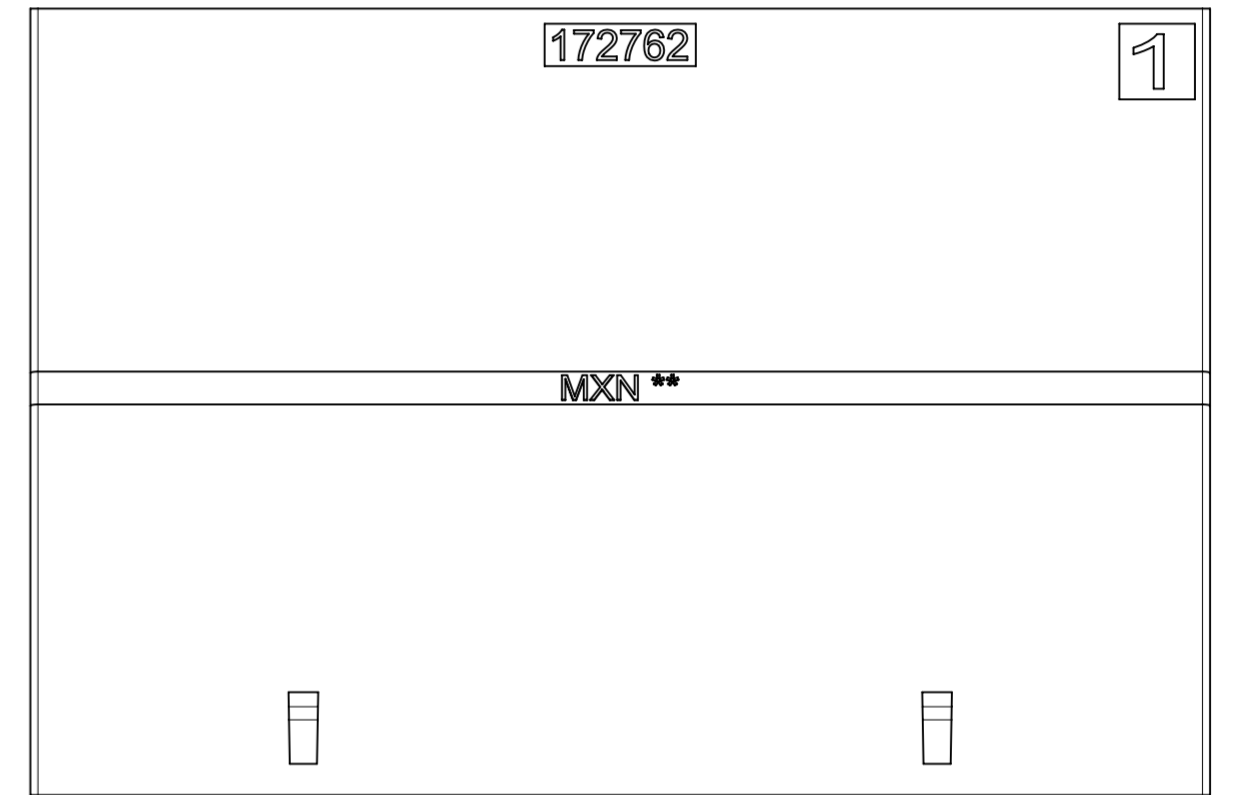

18-CKT

|   |        |                        |  |            |  |                                      |  |                 |  |                |  |              |  |
|---|--------|------------------------|--|------------|--|--------------------------------------|--|-----------------|--|----------------|--|--------------|--|
| THIS DRAWING CONTAINS INFORMATION THAT IS PROPRIETARY TO MOLEX ELECTRONIC TECHNOLOGIES, LLC AND SHOULD NOT BE USED WITHOUT WRITTEN PERMISSION |        |                        |  |            |  |                                      |  |                 |  |                |  |              |  |
| DIMENSION UNITS   | SCALE  | CURRENT REV DESC:      |  |            |  | <b>molex</b>                         |  |                 |  |                |  |              |  |
| mm  | NTS    |                        |  |            |  |                                      |  |                 |  |                |  |              |  |
| GENERAL TOLERANCES (UNLESS SPECIFIED)   |        |                        |  |            |  | SD-DRAWING OF MINI-FIT SIGMA DR PLUG |  |                 |  |                |  |              |  |
| ANGULAR TOL   | ± °    |                        |  |            |  | PRODUCT CUSTOMER DRAWING             |  |                 |  |                |  |              |  |
| 4 PLACES  | ±      | EC NO: 735375          |  | 2023/01/06 |  |                                      |  |                 |  |                |  |              |  |
| 3 PLACES  | ±      | DRWN: JERRYW8          |  | 2023/02/01 |  |                                      |  |                 |  |                |  |              |  |
| 2 PLACES  | ± 0.25 | CHK'D: XQZHANG         |  | 2023/02/01 |  |                                      |  |                 |  |                |  |              |  |
| 1 PLACE   | ± 0.36 | APPR: XQZHANG          |  | 2023/02/01 |  |                                      |  |                 |  |                |  |              |  |
| 0 PLACES  | ±      | INITIAL REVISION:      |  |            |  | DOCUMENT NUMBER                      |  |                 |  |                |  |              |  |
| DRAFT WHERE APPLICABLE MUST REMAIN WITHIN DIMENSIONS  |        | THIRD ANGLE PROJECTION |  | DRAWING    |  | SERIES                               |  | MATERIAL NUMBER |  | CUSTOMER       |  | SHEET NUMBER |  |
|   |        |                        |  | A2-SIZE    |  | 172762                               |  | SEE TABLE       |  | GENERAL MARKET |  | 4 OF 4       |  |
|   |        |                        |  |            |  |                                      |  | 1727620001-SD   |  | PSD 000        |  | A5           |  |