

General Specifications

Electrical Capacity

Resistive Load:	10A @ 125V AC or 6A @ 250V AC
Motor Load:	400W @ 125V AC
Lamp Load:	2A @ 125V AC for On-Off-On circuit & 3A @ 125V AC for other circuits

Other Ratings

Contact Resistance:	10 milliohms maximum
Insulation Resistance:	1,000 megohms minimum @ 500V DC
Dielectric Strength:	2,000V AC minimum between contacts for 1 minute minimum; 4,000V AC minimum between contacts & case for 1 minute minimum
Mechanical Life:	100,000 operations minimum
Electrical Life:	25,000 operations minimum
Angle of Throw:	25°

Materials & Finishes

Toggle Cap:	Polypropylene for No Code, Code D; Polyvinyl chloride for Code B (see Ordering Example)
Lever:	Brass with chrome plating
Bushing:	Brass with nickel plating
Frame:	Stainless steel
Case/Base:	Diallyl phthalate resin (UL94V-0)
Movable Contacts:	Silver alloy with silver plating
Stationary Contacts:	Pure silver with silver plating
Terminals:	Copper with silver plating

Environmental Data

Operating Temp Range:	-10°C through +85°C (+14°F through +185°F)
Humidity:	90 ~ 95% humidity for 96 hours @ 40°C (104°F)
Vibration:	10 ~ 55Hz with peak-to-peak amplitude of 1.5mm traversing the frequency range & returning in 1 minute; 3 right angled directions for 2 hours
Shock:	50G (490m/s ²) acceleration (tested in 6 right angled directions, with 5 shocks in each direction)

Installation

Soldering Time & Temp:	Wave Soldering Recommended (Straight PC): See Profile A in Supplement section. Manual Soldering: See Profile A in Supplement section.
Cleaning:	These devices are not process sealed. Hand clean locally using alcohol based solution.

Standards & Certifications

Flammability Standards:	UL94V-0 rated case/base
UL:	File No. E44145 - Recognized only when ordered with marking on switch. Add "/U" or "/CUL" to end of part number to order UL recognized switch. Models with No Code, E, F & D are recognized at 10A @ 125V AC & 6A @ 250V AC.
CSA:	File No. 023535_0_000 - Certified only when ordered with marking on switch. Add "/C" to end of part number to order CSA certified switch. Models with No Code, E, F and D are certified at 10A @ 125V AC & 6A @ 250V AC.
VDE:	License No. 119174 Models with No Code, B & D are approved at 10A @ 125V AC & 6A @ 250V AC. Models with No Code, B & D meet EN 61058-1 standard.

Distinctive Characteristics

Meets EN 61058-1 standard.

High torque bushing construction prevents rotation or separation from frame during installation.

Stainless steel frame resists corrosion and increases environmental safety.

Case/base of heat resistant resin meets UL94V-0 flammability standard.

Contacts of special silver alloy resist arcing and guarantee stable electrical contact and long life.

High insulating barriers increase isolation of circuits in double pole devices and provide added protection to contact points.

Prominent external insulating barriers increase insulation resistance and dielectric strength.

Epoxy sealed terminals prevent entry of flux, solvents, and other contaminants.

Clinching of the frame to the case well above the base and terminals provides 4,000V dielectric strength.

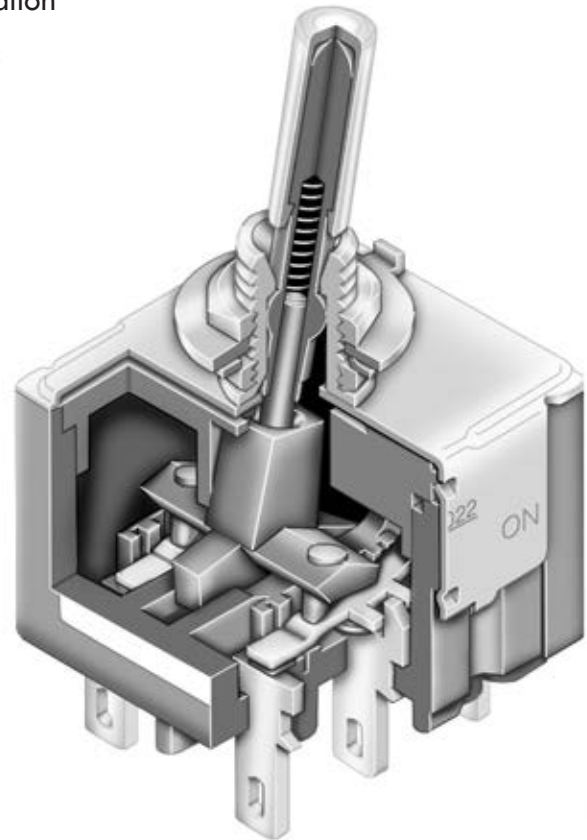

Actual Size

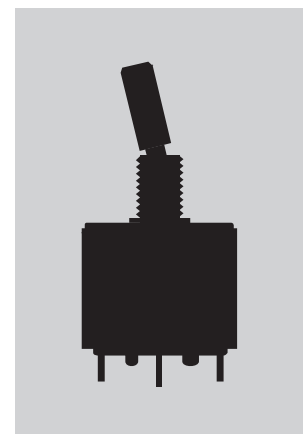

- A Toggles
- Rockers
- Pushbuttons
- Illuminated PB
- Programmable
- Keylocks
- Rotaries
- Slides
- Tactiles
- Tilt
- Touch
- Indicators
- Accessories
- Supplement

TYPICAL SWITCH ORDERING EXAMPLE

P20

22

B



Poles & Circuits				
11	SPST	ON	NONE	OFF
12	SPDT	ON	NONE	ON
13	SPDT	ON	OFF	ON
21	DPST	ON	NONE	OFF
22	DPDT	ON	NONE	ON
23	DPDT	ON	OFF	ON

Toggles & Bushings	
No Code	.512" (13.0mm) White Cap with 6mm Bushing
E	.450" (11.4mm) Flatted with 6mm Bushing
B	.689" (17.5mm) Large Bat & AT406B Cap with 12mm Bushing
F	.689" (17.5mm) Large Bat with 12mm Bushing
D	.748" (19.0mm) White Capped Column with 12mm Bushing

Terminals	
No Code	Solder Lug
P	Straight PC
Z	.187" (4.75mm) Quick Connect

DESCRIPTION FOR TYPICAL ORDERING EXAMPLE

P2022F

.689" (17.5mm) Large Bat with 12mm Bushing

DPDT ON-NONE-ON Circuit

Solder Lug Terminals



IMPORTANT:

VDE is marked on all models except those with codes E & F. Switches are supplied without UL, cULus & CSA marking unless specified. **UL, cULus & CSA recognized only when ordered with marking on the switch.** Specific models, ratings, & ordering instructions are noted on the General Specifications page.



POLES & CIRCUITS

Pole	Model	Toggle Position			Connected Terminals			Throw & Schematics
		Down <small>Keyway</small>	Center	Up	Down <small>Keyway</small>	Center	Up	
SP	P2011	ON	NONE	OFF	1-1b	OPEN	OPEN	SPST
SP	P2012 P2013	ON ON	NONE OFF	ON ON	1-1b	OPEN	1-1a	SPDT
DP	P2021	ON	NONE	OFF	1-1b 2-2b	OPEN	OPEN	DPST
DP	P2022 P2023	ON ON	NONE OFF	ON ON	1-1b 2-2b	OPEN	1-1a 2-2a	DPDT

TOGGLES & BUSHINGS

A Toggles

No Code

.512" (13.0mm) White Cap with 6mm Bushing

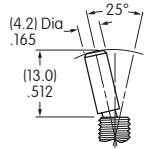

E

.450" (11.4mm) Flatted with 6mm Bushing

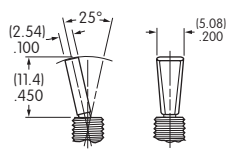

B

.689" (17.5mm) Large Bat & AT406B Cap with 12mm Bushing

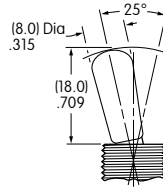

F

.689" (17.5mm) Large Bat with 12mm Bushing

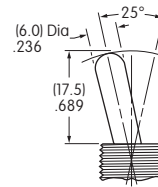

D

.748" (19.0mm) White Capped Column with 12mm Bushing

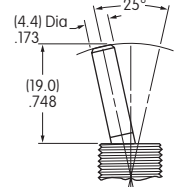

Rockers

Pushbuttons

Panel Cutouts

Panel Thickness with Keyway
.134" (3.4mm) maximum

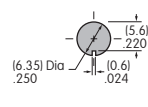

Panel Thickness with Locking Ring
.102" (2.6mm) maximum

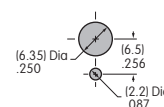

Panel Thickness with Keyway
.256" (6.5mm) maximum

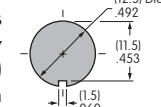

Panel Thickness with Locking Ring
.217" (5.5mm) maximum

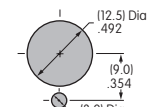

Illuminated PB

Programmable

Standard Hardware

For 6mm Bushing: 1 Locking Ring AT507M, 1 Internal Tooth Lockwasher AT509, 2 Hex Nuts AT513M

For 12mm Bushing: 1 Hex Face Nut AT503M, 1 Locking Ring AT506M, 1 Internal Tooth Lockwasher AT508, 1 Hex Mounting Nut AT527M

Optional Splashproof Boot Assemblies (for code F): AT401 & AT4181 boots plus hex nut & o-ring; see Accessories & Hardware section.

Keylocks

TERMINALS

No Code

Solder Lug

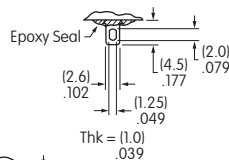

Z

.187" (4.75mm) Quick Connect

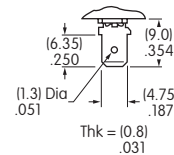

P

Straight PC

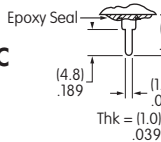

SPST

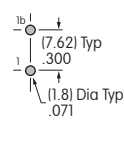

SPDT

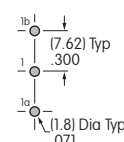

DPST

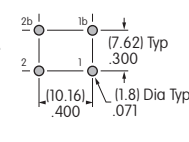

DPDT

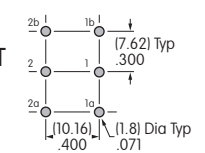

Rotaries

Slides

Tactiles

TYPICAL SWITCH DIMENSIONS

P2011, P2012, P2013

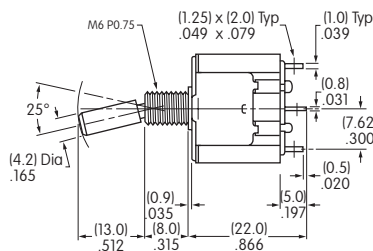
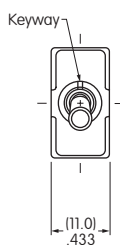

P2011 models do not have terminal 1a.

6mm Bushing



P2012

Tilt

Touch

Indicators

P2021F, P2022F, P2023F

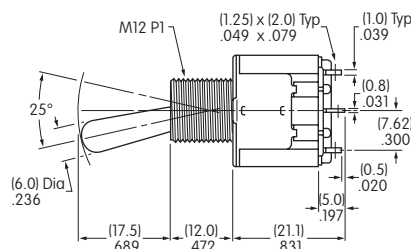
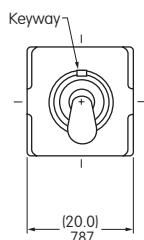

P2021 models do not have terminals 1a & 2a.

12mm Bushing

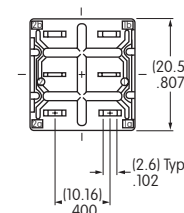

P2022F

Accessories

Supplement