

Specification

Drawing No.	TKY1T-H1-20465-00[41]
Issued Date.	August 5, 2020

TO: Digi-key

Note: In case of specification change, KYOCERA Part Number also will be changed.

Product Name	Crystal Oscillator
Product Model	_____
Frequency	xxx.xxx MHz (Refer to TKY1T-H1-20465-00[41]-9/9(Appendix 1 / Output Frequency))
Customer Part Number	_____
Customer Specification Number	_____
KYOCERA Part Number	KC7050Pxxx.xxxL20E00 (Refer to TKY1T-H1-20465-00[41]-9/9(Appendix 1 / KYOCERA Part Number))
Remarks	RoHS Compliant / MSL 1





Customer Acceptance

Accept Signature	Accept Date	
	Department	
	Person in charge	

Seller

KYOCERA Corporation
Corporate Electronic Components Group
Electronic Components Sales Division
6 Takeda Tobadono-cho, Fushimi-ku, Kyoto
612-8501 Japan
TEL. No. 075-604-3500
FAX. No. 075-604-3501

KYOCERA Corporation
Corporate Electronic Components Group
Crystal Components Division
Yamagata higashine Plant
5850, Higashine-koh, Higashine-shi, Yamagata
999-3701 Japan
TEL. No. 0237-43-5611
FAX. No. 0237-43-5615

Design Department	Quality Assurance	Approved by	Examined by	Written by
Design Engineering Section1 Crystal Components Division	Y. Kakuta 	N. Nakano 	K. Jikuhara 	Y. Kato 

KYOCERA Corporation

1. Scope

This specification shall be defined of the Clock Oscillator for the integrated circuits (ICs).

2. Customer Part Number

3. KYOCERA Part Number**KC7050Pxxx.xxxL20E00**

(Refer to TKY1T-H1-20465-00[41]-9/9(Appendix 1 / KYOCERA Part Number))

4. Electrical Characteristics**4-1. Absolute Maximum Rating**

Item	Symbol	Rated Value	Units
Power Supply Voltage	V _{CC}	-0.5 to +5.0	V
Input Voltage	V _{IN}	-0.5 to V _{CC} +0.5	V
Storage Temperature	T _{STG}	-55 to +125	°C

Note:

If the part is used beyond absolute maximum ratings, it may cause internal destruction. The part should be used under the recommended operating conditions the reliability of this part may be damaged if those conditions are exceeded.

4-2. Recommended Operating Conditions

Item	Symbol	Min	Typ	Max	Units	Remarks
Power Supply Voltage	V _{CC}	2.375	2.5	2.625	V	
Input Voltage	V _{IN}	0	---	V _{CC}	V	
Operating Temperature	T _{OPR}	-0	+25	+70	°C	

4-3. Electrical Characteristics

Item	Symbol	Min	Typ	Max	Units	Remarks
Output Frequency	f _o	---	※1	---	MHz	
Frequency Tolerance	f _{tol}	-50	---	+50	ppm	Include initial tolerance, operating temperature range, rated power supply voltage change, load change, aging (1year @+25°C), shock and vibration
Current Consumption	I _{CC}	---	---	70	mA	
Standby Current	I _{ST}	---	---	30	μA	
Symmetry (Duty Ratio)	SYM	45	50	55	%	100ohm, @ crossing point
Rise Time (20% to 80% Output Swing)	T _r	---	---	0.6	ns	100ohm
Fall Time (80% to 20% Output Swing)	T _f	---	---	0.6		
Output voltage -"L"	V _{OL}	0.9	1.1	---	V	
Output voltage -"H"	V _{OH}	---	1.43	1.6		
Differential Output Voltage	V _{OD}	247	330	454	mV	
Differential Output Voltage Error	dV _{OD}	---	---	50		dV _{OD} = V _{OD1} - V _{OD2}
Offset Voltage	V _{OS}	1.125	1.25	1.375	V	
Offset Voltage Error	dV _{OS}	---	---	50	mV	dV _{OS} = V _{OS1} - V _{OS2}
Output Load	---	100			ohm	LVDS Output
Input Voltage -"L"	V _{IL}	---	---	30% V _{CC}	V	
Input Voltage -"H"	V _{IH}	70% V _{CC}	---	---		
Output Disable Time	t _{dis}	---	---	200	ns	
Output Enable Time	t _{ena}	---	---	10	ms	
Start up time	t _{sta}	---	---	10	ms	@Minimum operating voltage to be 0sec
Deterministic Jitter*	DJ	---	---	2	ps	DJ pk-pk
1sigma Jitter*	J _{Sigma}	---	---	4		
Peak to Peak Jitter*	J _{PK-PK}	---	---	30		

Note: All electrical characteristics have defined on the maximum loaded and recommended operating conditions.

* Based on Time Interval Analyzer "Wavecrest SIA-3000".

Table 1

※1 Refer to TKY1T-H1-20465-00[41]-9/9(Appendix 1 / Output Frequency)

4-4. Measurement Condition

The reference temperature shall be $+25\pm 2^{\circ}\text{C}$. The measurement shall be performed at the temperature range of $+5^{\circ}\text{C}$ to $+35^{\circ}\text{C}$ unless otherwise the result is doubtful.

4-5. Measurement Circuit

The electrical characteristics shall be measured by test circuit "Fig. 1". Also jitter shall be measured by test circuit "Fig. 4".

4-6. Clock Timing Chart

The clock timing charts are "Fig. 2" and "Fig. 3".

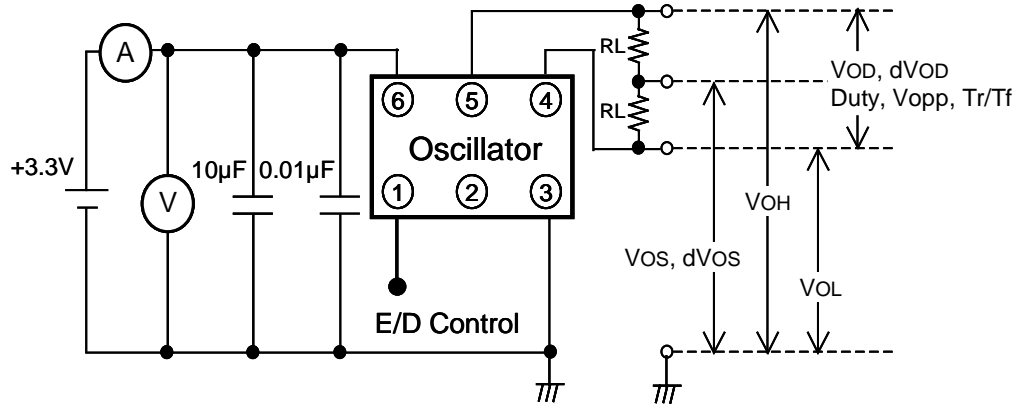

Fig.1 Test Circuit

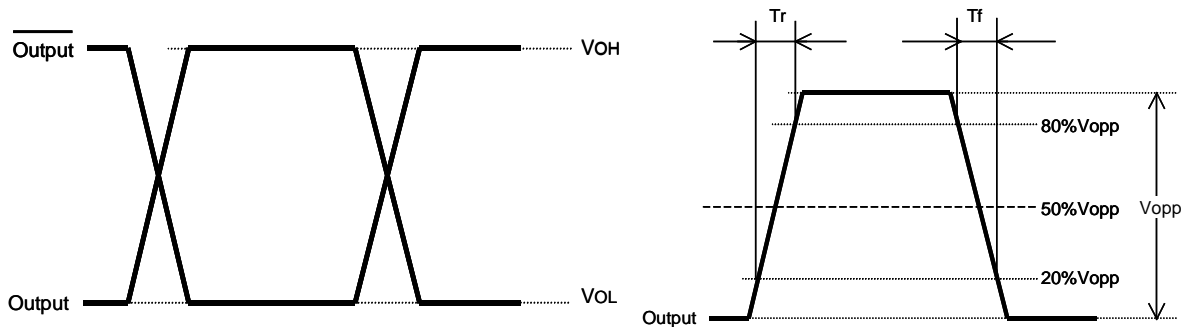

Fig.2 Clock Timing Chart 1

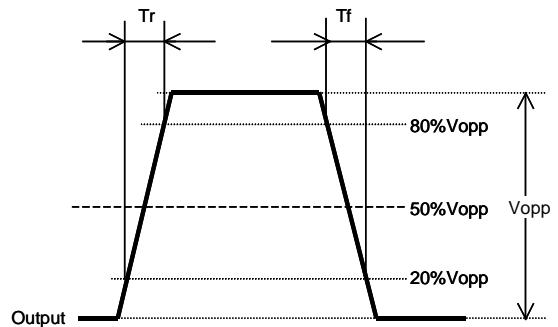

Fig.3 Clock Timing Chart 2

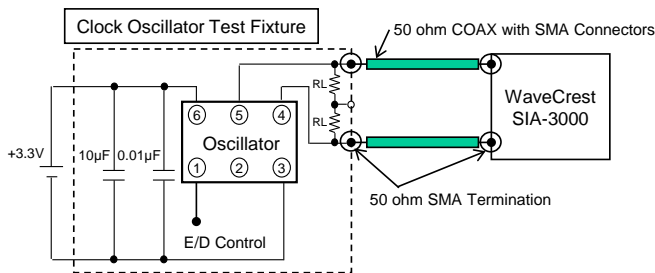
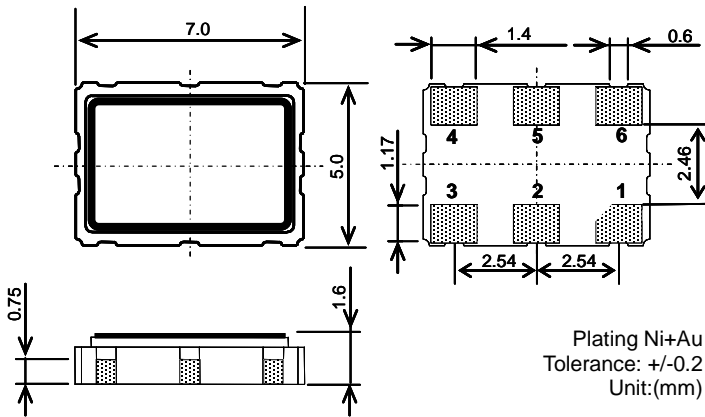

Fig.4 Jitter Test Circuit

<Measurement Conditions>

- Time Interval Analyzer
 - WaveCrest SIA-3000
- DTS timer calibration
 - Over 30 minutes warm-up
 - Extend 30 minutes calibration
- Jitter histogram conditions (Tail-fit)
 - More than 50,000cyc Hits
 - Bit Error Ratio (BER) -12 (14sigma)

5. Dimensions and Marking



Plating Ni+Au
Tolerance: +/-0.2
Unit:(mm)

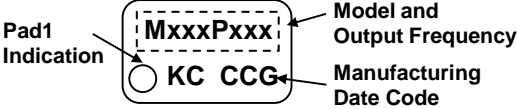

Output Frequency
The output frequency is seven-digit including a decimal point. The frequency greater than the number of digits have rounded off. (E.g. 133.3333MHz → "133.333")

Model

See Table 2

Manufacturing Date Code

Year	Code	Year	Code	Month	Code	Day	Code	Day	Code	Day	Code
2001	A	2011	L	1	1	1	1	11	B	21	M
2002	B	2012	M	2	2	2	2	12	C	22	N
2003	C	2013	N	3	3	3	3	13	D	23	P
2004	D	2014	P	4	4	4	4	14	E	24	Q
2005	E	2015	Q	5	5	5	5	15	F	25	R
2006	F	2016	R	6	6	6	6	16	G	26	S
2007	G	2017	S	7	7	7	7	17	H	27	T
2008	H	2018	T	8	8	8	8	18	J	28	V
2009	J	2019	V	9	9	9	9	19	K	29	W
2010	K	2020	W	10	A	10	A	20	L	30	X
It repeats from A in 2021 and afterwards.				11	B	11	B	18	J	28	V
				12	C	12	C	17	H	27	T
						10	A	20	L	30	X
						11	B	19	K	29	W
						12	C	18	J	28	V
						1	1	11	B	21	M
						2	2	12	C	22	N
						3	3	13	D	23	P
						4	4	14	E	24	Q
						5	5	15	F	25	R
						6	6	16	G	26	S
						7	7	17	H	27	T
						8	8	18	J	28	V
						9	9	19	K	29	W
						10	A	20	L	30	X
						11	B	19	K	29	W
						12	C	18	J	28	V
								Without I, O, U, Z		31	Y

e.g. "C46" means "Apr-6-2003"

Pad arrangement	
1	Enable/Disable
2	NC
3	Case GND
4	Output
5	Complementary Output
6	V _{CC}

Enable/Disable Function	
Pad1	Pad4/Pad5
OPEN	Active
"H" Level	Active
"L" Level	No-Oscillation

Stability		Model Code	
Code	(ppm)	KC7050Pxxx.xxxL20E00	
0	±50	MxxxNxxx *Refer to TKY1T-H1-20465-00[41]-9/9 (Appendix 1 / Marking)	

Table 2

6. Parts Numbering Guide

KC7050P xxx.xxx L 2 0 E 00
 A B C D E F G

- A. Series (6pad SMD Crystal Oscillator)
- B. Output Frequency
- C. Output
L: LVDS
- D. Supply Voltage
2: 2.5V
- E. Frequency Tolerance*
0: ±50ppm

- F. Symmetry (Duty Ratio) and Enable/Disable Function
E: Symmetry: 45% to 55% with Stand-by Function
- G. Suffix for Individual Requirements
(STD Specification is "00")

Packing (Tape & Reel 1,000pcs/Reel)
 *Over All Conditions:
 Include initial tolerance, operating temperature range, rated power supply voltage change, load change, aging (1year @+25°C), shock and vibration

7. Environmental Characteristics

Items	Conditions	Criteria of Acceptance
7-1. Solderability	Soaking: +245±5°C, 5.0±0.5sec	Dipped potion: Minimum 95% coverage
7-2. Soldering Heat Resistance	Reflow soldering: Peak +260°C max, 10sec, Twice max Soldering iron: +380±5°C, 3+1/-0sec, Twice as one time for six pads	Without looseness or crack etc.
7-3. Temperature Cycle	10 cycles: -55°C to +125°C (30minuts each/ cycle)	Clause 7-10 shall be satisfied.
7-4. Mechanical Shock (Pulse)	5 times 14,750m/sec ² (1,500G), Duration of pulse 0.5msec (MIL-STD-883D-2002.3 Condition B)	
7-5. Vibration	4 times each axis X, Y, Z: 20 to 2,000Hz and 2,000Hz to 20Hz/cycle Peak acceleration 196m/sec ² (20G) (MIL-STD-883D-2007.2 Condition A)	
7-6. High Temperature	1000 hours: Temperature: +85+5/-3°C	
7-7. Low Temperature	1000 hours: Temperature: -40+5/-3°C	
7-8. Humidity Cycle	10 cycles: Based on 1004 specifications (MIL-STD-883D-1004.7)	Clause 7-1 shall be satisfied.
7-9. Hermeticity 1 (Gross leak)	Soaking: +125°C, 5minutes	No bubbles appeared
7-10. Hermeticity 2 (Fine leak)	Measured by Helium Detector Equipment (MIL-STD-883D-1014.10 Condition A1)	5x10 ⁻⁹ Pa m ³ /sec max

After each testing, the parts shall be subjected to standard atmospheric conditions more than 2 hours. After that, the electrical characteristics shall be measured. The result of the test shall be satisfied **Table 1**.

Table 3

8. Recommended Land pattern and Soldering Guide

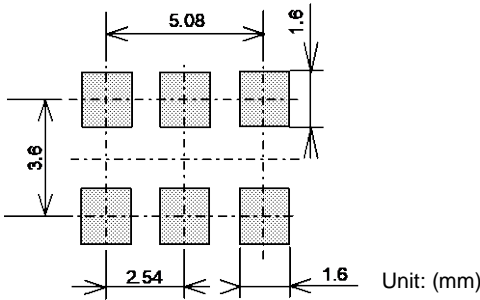

Note:
Since the part doesn't have Bypass Capacitor between V_{cc} and GND, Please mount high frequency type capacitor 0.01µF and 10µF to the nearest position of oscillator.

Fig.4 Land pattern

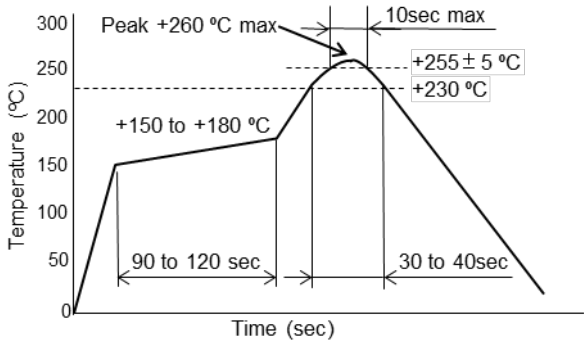

• Available Reflow times: Maximum twice
Fig.5 Reflow profile (Lead Free Available)

8-1.Soldering Iron Conditions

- Tip temperature of soldering iron: +380°C±5°C, Soldering time: 3sec+1/-0sec
- Numbers of soldering iron: Maximum twice as one time for 6 pads

9. Taping Specifications

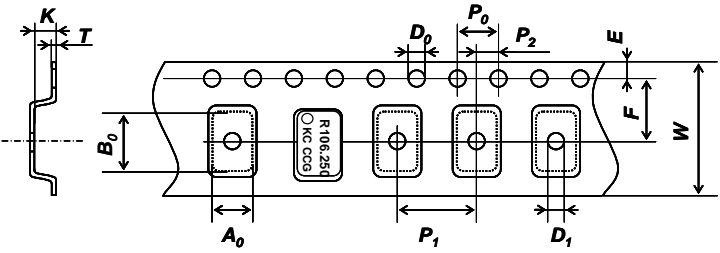

Unit: (mm)

Symbol	A₀	B₀	W	F	E
Dimensions	5.4±0.1	7.4±0.1	16.0±0.2	7.5±0.1	1.75±0.1
Symbol	P₁	P₂	P₀	D₀	T
Dimensions	8.0±0.1	2.0±0.1	4.0±0.1	1.5+0.1/-0	0.3±0.05
Symbol	K	D₁			
Dimensions	2.0±0.1	1.55±0.1			

Fig.6 Emboss Carrier Tape

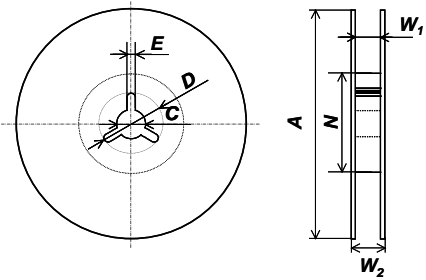

Unit: (mm)

Symbol	A	N	W₁
Dimensions	180 +0/-3	60+1/-0	17.0±0.2
Symbol	W₂	C	D
Dimensions	19.5±1.0	13.0±0.2	21.0±0.8
Symbol	E		
Dimensions	2.0±0.5		

Fig.7 Reel

9-1. Taping Quantities

- The taping of per reel shall be packed 1,000 pcs.
- The parts shall be contained continuously in the pocket.

9-2. Leader and Blank Pockets

- The package shall be consisted of leader, blank pockets and loaded pocket as follows “Fig. 8”.
- The power of peeling strength between top tape and carrier tape shall be 0.1N(10gf) to 0.7N(70gf) as follows “Fig. 9”.

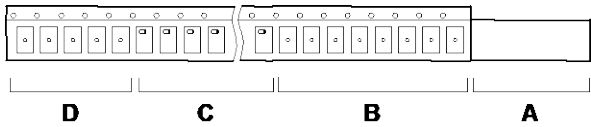

- A) Leader
- B) Blank Pocket (40mm to 320mm)
A+B: 400mm to 560mm
- C) Load Pocket
- D) Blank Pocket (160mm minimum)

Fig.8 Packing Method

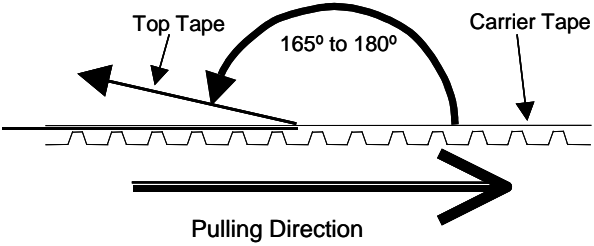

Fig.9 Peeling Strength

9-3. Reel Label

The reel label shall be consisted as below. (Based on EIAJ C-3 format)

- A) Customer Part Number
- B) Lot No.
- C) Quantities
- D) Shipping Date
- E) Vender Name

9-4. Exterior Package Label

The oscillator shall be packed properly to avoid defect in transportation. The exterior package label shall be consisted as below.

- A) Name of Customer
- B) P/O No.
- C) Customer Part Number
- D) Lot No.
- E) Quantities
- F) Shipping Date
- G) Vender Name

10. The agreement of this specifications

In case there is any obscure point or doubt concerning the contents of the specification, it shall be settled through consultation of both parties.

11. Remarks on Usages

A) Storage Conditions

The parts shall be stored in temperature range of -5 to +40°C, humidity 40 to 60% RH, and avoid direct sunlight. Then the parts shall be used within 6 months.

B) Handling Conditions

Although the part has protection circuit against static electricity, when excess static electricity is applied, the inside IC may get damaged.

Before mounting on the PCB, please make sure the direction of the part is correct. Otherwise the part of temperature will increase. And also the part will have some damages.

Please do not use the parts under the unfavorable condition such as beyond specified range in this specification.

Please do not use the parts under the condition, in the water or in the salt water also environment of dew or harmful gas.

C) Soldering Conditions

This product can respond to the general Pb-free reflow profile. The wave soldering can not be supported.

D) Soldering in Mounting

In case of Solder paste and conductive glue contact product lid or product side face exception for product terminal it's possible to influence product characteristics.

Please be careful above contents.

E) Washing Conditions

Ultra sonic cleaning is available. However there is a possibility that Crystal in the part may cause damaged under certain condition. Therefore please test before using.

After washing, please dry the parts completely. Otherwise water drops between the parts and PCB may cause migration.

In case of using this part without above precaution, Kyocera is unable to guarantee the specific characteristics.

12. Quality guarantee

In case when Kyocera Corporation rooted failure occurred within 1year after its delivery, substitute product will be arranged based on discussion. Quality guarantee of product after 1year of its delivery is waived.

Drawing No.	TKY1T-H1- 20465-00[41]
-------------	------------------------

No	Customer Part Number	Output Frequency (MHz)	KYOCERA Part Number	Marking (Model and Output Frequency)
1	-----	125.000	KC7050P125.000L20E00	M125P000
2	-----	150.000	KC7050P150.000L20E00	M150P000
3	-----	156.250	KC7050P156.250L20E00	M156P250