

- 1
- 2
- 3
- 4
- 5
- 6
- 7
- 8
- 9
- 10
- 11
- 12
- 13
- 14
- 15
- 16
- 17
- 18

MATERIAL

Glass-fibre reinforced polyamide based (PA) technopolymer body, black colour, matte finish, UV resistant.

SPRINGS

Stainless steel.

STANDARD EXECUTIONS

Assembly by means of pass-through holes for M5 cylindrical head screws.

- **CFVT-CH:** without detent (free rotation).
- **CFVT-CH-80:** detent with angle -70° / -7° / 80°, resistant torque 0.7 Nm or 1.2 Nm or 1.7 Nm.
- **CFVT-CH-115:** detent with angle -70° / -7° / 115°, resistant torque 0.7 Nm or 1.2 Nm or 1.7 Nm.
- **CFVT-CH-150:** detent with angle -70° / -7° / 150°, resistant torque 0.7 Nm or 1.2 Nm or 1.7 Nm.

ROTATION ANGLE (APPROXIMATE VALUE)

Max rotation angle: about 255° (-75° and +180° being 0° the condition where the two interconnected surfaces are on the same plane).

Do not exceed the rotation angle limit so as not to prejudice the hinge mechanical performance.

RESISTANT TORQUE

The resistant torque corresponds to the torque that must be applied to free the detent hinge.

The hinge has been tested with more than 20.000 opening and closing cycles and the values of the resistant torque were unchanged.

FEATURES AND APPLICATIONS

The internal detent device (ELESA patent) allows three different detent positions of the door depending on the execution.

When the hinge is in a range of +/- 25° with respect to a detent position, it reaches one of these positions (Fig.1) thanks to the internal device.

Value detected in special tests without load application. To choose the convenient type and the right number of hinges for your application, see the Guidelines (see page 952).

ACCESSORIES ON REQUEST

Polyester based (PBT) technopolymer screw-covers, black colour, matte finish, easy snap-in assembly. (see table CA.CFVT.).

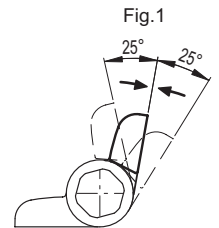
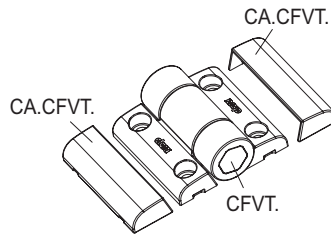

Code	Description
427702	CA.CFVT.53-C9

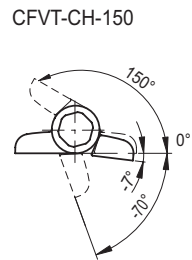
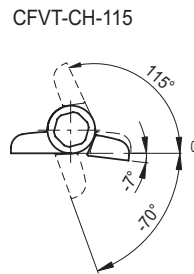
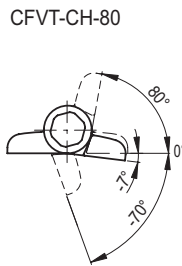
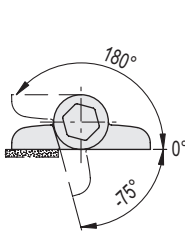

Description	Axial Stress		Radial Stress		90° Angled Stress	
	Maximum working load Ea [N]	Load at breakage Ra [N]	Maximum working load Er [N]	Load at breakage Rr [N]	Maximum working load E90 [N]	Load at breakage R90 [N]
CFVT	300	2100	400	1900	250	1800

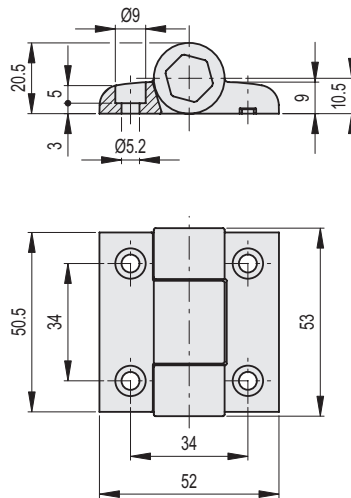

METRIC

Code	Description	Detent angle	Resistant torque* [Nm]	C# [Nm]	
427701	CFVT.53 CH-5	-	-	4	35
427704	CFVT.53 CH-5-80-0.7	-70° / -7° / +80°	0.7	4	36
427706	CFVT.53 CH-5-80-1.2	-70° / -7° / +80°	1.2	4	36
427708	CFVT.53 CH-5-80-1.7	-70° / -7° / +80°	1.7	4	36
427714	CFVT.53 CH-5-115-0.7	-70° / -7° / +115°	0.7	4	36
427716	CFVT.53 CH-5-115-1.2	-70° / -7° / +115°	1.2	4	36
427718	CFVT.53 CH-5-115-1.7	-70° / -7° / +115°	1.7	4	36
427724	CFVT.53 CH-5-150-0.7	-70° / -7° / +150°	0.7	4	36
427726	CFVT.53 CH-5-150-1.2	-70° / -7° / +150°	1.2	4	36
427728	CFVT.53 CH-5-150-1.7	-70° / -7° / +150°	1.7	4	36

* Torque to be applied to free the detent device of the hinge.
Suggested torque for screw assembly.