

Silicon SP4T Switch, Nonreflective, 9 kHz to 45 GHz

FEATURES

- ▶ Ultrawideband frequency range: 9 kHz to 45 GHz
- ▶ Nonreflective 50 Ω design
- ▶ Low insertion loss
 - ▶ 1.3 dB to 18 GHz typical
 - ▶ 2.2 dB to 40 GHz typical
 - ▶ 3.3 dB to 45 GHz typical
- ▶ High isolation
 - ▶ 44 dB to 18 GHz typical
 - ▶ 40 dB to 40 GHz typical
 - ▶ 35 dB to 45 GHz typical
- ▶ High input linearity
 - ▶ P0.1dB: >30 dBm typical
 - ▶ IP3: 50 dBm typical
- ▶ High RF input power
 - ▶ 30 dBm through path
 - ▶ 18 dBm terminated path
- ▶ No low frequency spurious
- ▶ ESD ratings
 - ▶ HBM: ±2000 V for all pins
 - ▶ CDM: ±500 V for all pins
- ▶ On and off time (50% V_{CTRL} to 90% of final RF_{OUT}): 2.7 μs
- ▶ 0.1 dB RF settling time (50% V_{CTRL} to 0.1 dB of final RF output): 3.4 μs
- ▶ 3 mm x 3 mm, 24-terminal LGA package
- ▶ Pin compatible with the [ADRF5042](#) and [ADRF5043](#)

APPLICATIONS

- ▶ Industrial scanners
- ▶ Test instrumentation
- ▶ Cellular infrastructure—mmWave 5G
- ▶ Military radios, radars, and electronic counter measures (ECMs)
- ▶ Microwave radios and very small aperture terminals (VSATs)

FUNCTIONAL BLOCK DIAGRAM

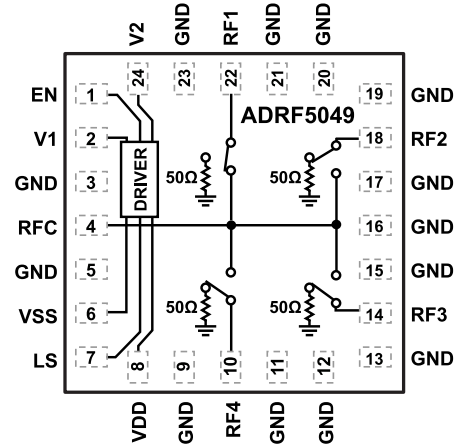

Figure 1. Functional Block Diagram

GENERAL DESCRIPTION

The ADRF5049 is a nonreflective SP4T switch manufactured in the silicon on insulator (SOI) process.

This device operates from 9 kHz to 45 GHz with an insertion loss of lower than 3.3 dB and isolation of higher than 35 dB. The ADRF5049 has an RF input power handling capability of 30 dBm through path, 18 dBm terminated path, and 30 dBm hot switching at the RF common port.

The ADRF5049 requires a dual-supply voltage of +3.3 V and -3.3 V. The device employs complimentary metal-oxide semiconductor (CMOS)-/low-voltage transistor to transistor logic (LVTTTL) logic-compatible controls.

The ADRF5049 has enable and logic select controls to feature all off state and mirror port selection, respectively.

The ADRF5049 is pin compatible with the [ADRF5042](#) and [ADRF5043](#).

The ADRF5049 comes in a 24-terminal, 3 mm × 3 mm, RoHS compliant, land grid array (LGA) package and can operate from -40°C to +105°C.

TABLE OF CONTENTS

Features.....	1	Interface Schematics.....	8
Applications.....	1	Typical Performance Characteristics.....	9
Functional Block Diagram.....	1	Insertion Loss, Return Loss, and Isolation.....	9
General Description.....	1	Input Power Compression and Third-Order Intercept.....	11
Specifications.....	3	Theory of Operation.....	12
Absolute Maximum Ratings.....	5	Applications Information.....	13
Thermal Resistance.....	5	Recommendations for PCB Design.....	13
Power Derating Curves.....	5	Outline Dimensions.....	14
Electrostatic Discharge (ESD) Ratings.....	6	Ordering Guide.....	14
ESD Caution.....	6	Evaluation Boards.....	14
Pin Configuration and Function Descriptions.....	7		

REVISION HISTORY**2/2023—Revision 0: Initial Version**

SPECIFICATIONS

Positive supply voltages (V_{DD}) = 3.3 V, negative supply voltage (V_{SS}) = -3.3 V, Control Input 1 voltage (V_1) = 0 V or 3.3 V, Control Input 2 voltage (V_2) = 0 V or 3.3 V, T_A = 25°C, and it is a 50 Ω system, unless otherwise noted. V_{CTRL} is the voltages of the digital control inputs, V_1 and V_2 .

Table 1. Specifications

Parameter	Test Conditions/Comments	Min	Typ	Max	Unit
FREQUENCY RANGE, f		0.009		45000	MHz
INSERTION LOSS					
Between RFC and RF1 to RF4 (On)	9 kHz to 18 GHz		1.3		dB
	18 GHz to 26 GHz		1.5		dB
	26 GHz to 35 GHz		1.8		dB
	35 GHz to 40 GHz		2.2		dB
	40 GHz to 45 GHz		3.3		dB
ISOLATION					
Between RFC and RF1 to RF4 (Off)	9 kHz to 18 GHz		44		dB
	18 GHz to 26 GHz		42		dB
	26 GHz to 35 GHz		42		dB
	35 GHz to 40 GHz		40		dB
	40 GHz to 45 GHz		35		dB
RETURN LOSS					
RFC and RF1 to RF4 (On)	9 kHz to 18 GHz		18		dB
	18 GHz to 26 GHz		19		dB
	26 GHz to 35 GHz		17		dB
	35 GHz to 40 GHz		18		dB
	40 GHz to 45 GHz		13		dB
RF1 to RF4 (Off)	9 kHz to 18 GHz		20		dB
	18 GHz to 26 GHz		17		dB
	26 GHz to 35 GHz		14		dB
	35 GHz to 40 GHz		13		dB
	40 GHz to 45 GHz		12		dB
SWITCHING					
Rise and Fall Time (t_{RISE} , t_{FALL})	90% to 10% of RF output (RF_{OUT})		1.2		μ s
On and Off Time (t_{ON} , t_{OFF})	50% V_{CTRL} to 10% to 90% of RF_{OUT}		2.7		μ s
0.1 dB RF Settling Time	50% V_{CTRL} to 0.1 dB of final RF_{OUT}		3.4		μ s
INPUT LINEARITY					
0.1 dB Power Compression (P0.1dB)	f = 1 MHz to 40 GHz		>30		dBm
Third-Order Intercept (IP3)	Two-tone input power = 14 dBm continuous wave per tone, f = 1 MHz to 40 GHz, Δf = 1 MHz		50		dBm
SUPPLY CURRENT	VDD and VSS pins				
Positive Supply Current (I_{DD})			150		μ A
Negative Supply Current (I_{SS})			520		μ A
DIGITAL CONTROL INPUTS					
Voltage					
Low (V_{INL})		0		0.8	V
High (V_{INH})		1.2		3.45	V
Current					
Low (I_{INL})			<1		μ A
High (I_{INH})	V1 and V2 pins		<1		μ A
	EN and LS pins		33		μ A

SPECIFICATIONS

Table 1. Specifications (Continued)

Parameter	Test Conditions/Comments	Min	Typ	Max	Unit
RECOMMENDED OPERATING CONDITIONS					
Supply Voltage					
V_{DD}		3.15		3.45	V
V_{SS}		-3.45		-3.15	V
V_1 and V_2		0		V_{DD}	V
RF Input Power	$f = 1 \text{ MHz to } 40 \text{ GHz}$, $T_{CASE} = 85^\circ\text{C}$, life time				
Through Path	RF signal is applied to RFC or through connected RFx			30	dBm
Terminated Path	RF signal is applied to terminated RFx			18	dBm
Hot Switching	RF signal is present at RFC while switching between RFx			30	dBm
T_{CASE}		-40		+105	$^\circ\text{C}$

ABSOLUTE MAXIMUM RATINGS

Table 2. Absolute Maximum Ratings

Parameter	Rating
Supply Voltage	
V_{DD}	-0.3 V to +3.6 V
V_{SS}	-3.6 V to +0.3 V
Digital Control Inputs Voltage	-0.3 V to $V_{DD} + 0.3$ V
RF Input Power (Frequency ¹ = 1 MHz to 40 GHz, $T_{CASE} = 85^{\circ}C^2$)	
Through Path	30.5 dBm
Terminated Path	18.5 dBm
Hot Switching	30.5 dBm
Temperature	
Junction	135°C
Storage	-65°C to +150°C
Reflow	260°C

- ¹ For power derating over frequency, see [Figure 2](#) and [Figure 3](#).
- ² For 105°C operation, the power handling degrades from the $T_{CASE} = 85^{\circ}C$ specifications by 3 dB.

Stresses at or above those listed under Absolute Maximum Ratings may cause permanent damage to the product. This is a stress rating only; functional operation of the product at these or any other conditions above those indicated in the operational section of this specification is not implied. Operation beyond the maximum operating conditions for extended periods may affect product reliability. Only one absolute maximum rating can be applied at any one time.

THERMAL RESISTANCE

Thermal performance is directly linked to printed circuit board (PCB) design and operating environment. Careful attention to PCB thermal design is required.

θ_{JC} is the junction to case bottom (channel to package bottom) thermal resistance.

Table 3. Thermal Resistance

Package Type	θ_{JC} ¹	Unit
CC-24-14		
Through Path	104	°C/W
Terminated Path	790	°C/W

- ¹ θ_{JC} was determined by simulation under the following conditions: the heat transfer is due solely to the thermal conduction from the channel through the ground pad to the PCB, and the ground pad is held constant at the operating temperature of 105°C.

POWER DERATING CURVES

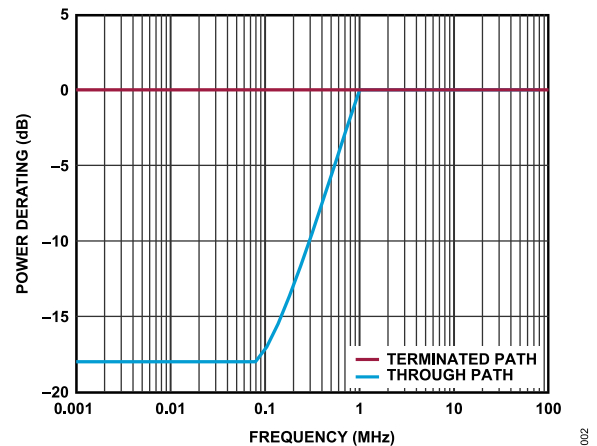

Figure 2. Power Derating vs. Frequency, Low Frequency Detail, $T_{CASE} = 85^{\circ}C$

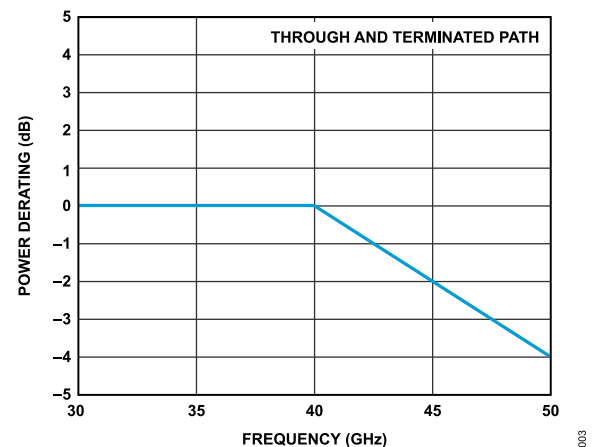

Figure 3. Power Derating vs. Frequency, High Frequency Detail, $T_{CASE} = 85^{\circ}C$

ABSOLUTE MAXIMUM RATINGS**ELECTROSTATIC DISCHARGE (ESD) RATINGS**

The following ESD information is provided for handling of ESD-sensitive devices in an ESD protected area only.

Human body model (HBM) per ANSI/ESDA/JEDEC JS-001.

Charged device model (CDM) per ANSI/ESDA/JEDEC JS-002.

ESD Ratings for the ADRF5049

Table 4. ADRF5049, 24-Terminal LGA

ESD Model	Withstand Threshold (V)	Class
HBM	±2000 for All Pins	2
CDM	±500 for All Pins	C2

ESD CAUTION

ESD (electrostatic discharge) sensitive device. Charged devices and circuit boards can discharge without detection. Although this product features patented or proprietary protection circuitry, damage may occur on devices subjected to high energy ESD. Therefore, proper ESD precautions should be taken to avoid performance degradation or loss of functionality.

PIN CONFIGURATION AND FUNCTION DESCRIPTIONS

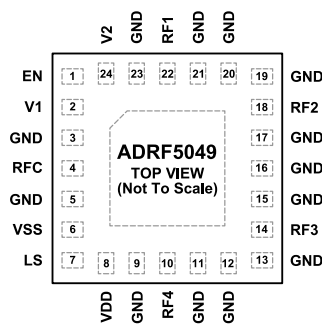

NOTES
 1. EXPOSED PAD. THE EXPOSED PAD MUST BE CONNECTED TO THE RF AND DC GROUND OF THE PCB.

Figure 4. Pin Configuration

Table 5. Pin Function Descriptions

Pin No.	Mnemonic	Description
1	EN	Enable Input. See Table 6 for the truth table and Figure 7 for the control interface schematic.
2	V1	Control Input 1. See Table 6 for the truth table and Figure 6 for the control interface schematic.
3, 5, 9, 11 to 13, 15 to 17, 19 to 21, 23	GND	Ground.
4	RFC	RF Common Port. The RFC pin is dc-coupled to 0 V and ac matched to 50 Ω. No dc blocking capacitor is required when the RF line potential is equal to 0 V dc. See Table 6 for the truth table and Figure 5 for the interface schematic.
6	VSS	Negative Supply Voltage.
7	LS	Logic Select. See Table 6 for the truth table and Figure 7 for the control interface schematic.
8	VDD	Positive Supply Voltage.
10	RF4	RF Throw Port 4. The RF4 pin is dc-coupled to 0 V and ac matched to 50 Ω. No dc blocking capacitor is required when the RF line potential is equal to 0 V dc. See Table 6 for the truth table and Figure 5 for the interface schematic.
14	RF3	RF Throw Port 3. The RF3 pin is dc-coupled to 0 V and ac matched to 50 Ω. No dc blocking capacitor is required when the RF line potential is equal to 0 V dc. See Table 6 for the truth table and Figure 5 for the interface schematic.
18	RF2	RF Throw Port 2. The RF2 pin is dc-coupled to 0 V and ac matched to 50 Ω. No dc blocking capacitor is required when the RF line potential is equal to 0 V dc. See Table 6 for the truth table and Figure 5 for the interface schematic.
22	RF1	RF Throw Port 1. The RF1 pin is dc-coupled to 0 V and ac matched to 50 Ω. No dc blocking capacitor is required when the RF line potential is equal to 0 V dc. See Table 6 for the truth table and Figure 5 for the interface schematic.
24	V2	Control Input 2. See Table 6 for the truth table and Figure 6 for the control interface schematic.
	EPAD	Exposed Pad. The exposed pad must be connected to the RF and dc ground of the PCB.

PIN CONFIGURATION AND FUNCTION DESCRIPTIONS

INTERFACE SCHEMATICS

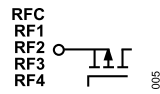

Figure 5. RFX Interface Schematic

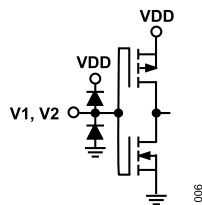

Figure 6. V1 and V2 Control Interface Schematic

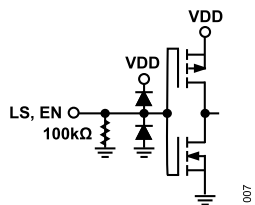

Figure 7. LS and EN Control Interface Schematic

TYPICAL PERFORMANCE CHARACTERISTICS

INSERTION LOSS, RETURN LOSS, AND ISOLATION

$V_{DD} = 3.3\text{ V}$, $V_{SS} = -3.3\text{ V}$, $EN = 0\text{ V}$, $V_1 = 0\text{ V}$ or 3.3 V , $V_2 = 0\text{ V}$ or 3.3 V , $LS = 0\text{ V}$ or 3.3 V , and $T_{CASE} = 25^\circ\text{C}$ on a $50\ \Omega$ system, unless otherwise noted.

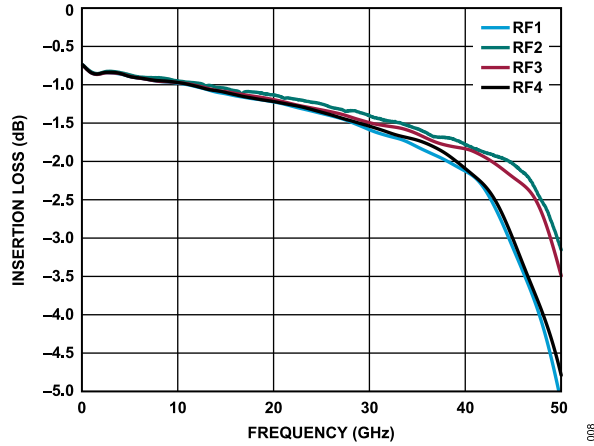

Figure 8. Insertion Loss for RFC to RFx Selected vs. Frequency

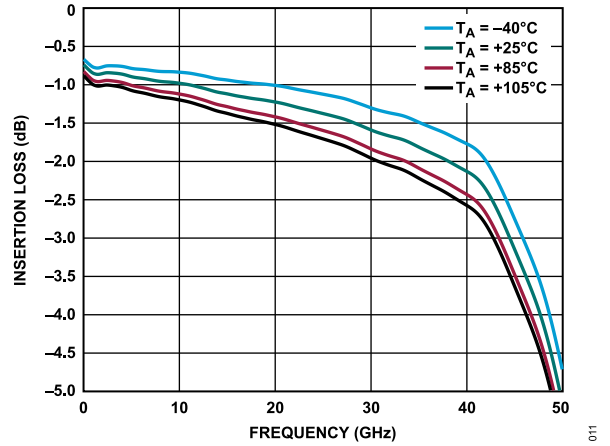

Figure 11. Insertion Loss for RFC to RF1 vs. Frequency over Temperature

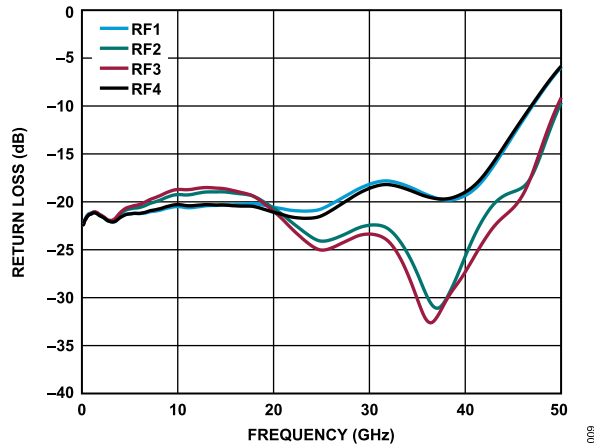

Figure 9. Return Loss for RFC when RFx Selected vs. Frequency

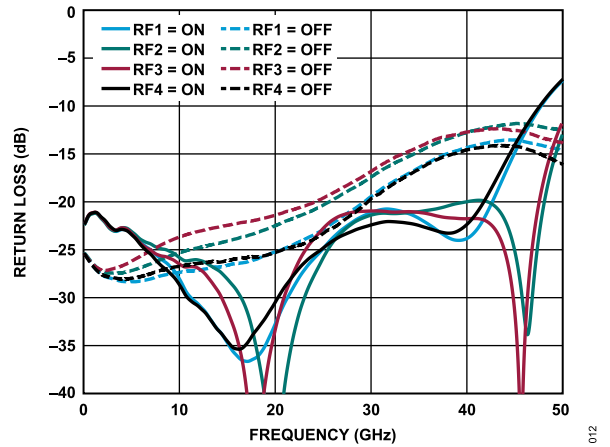

Figure 12. Return Loss for RFx Unselected and Selected

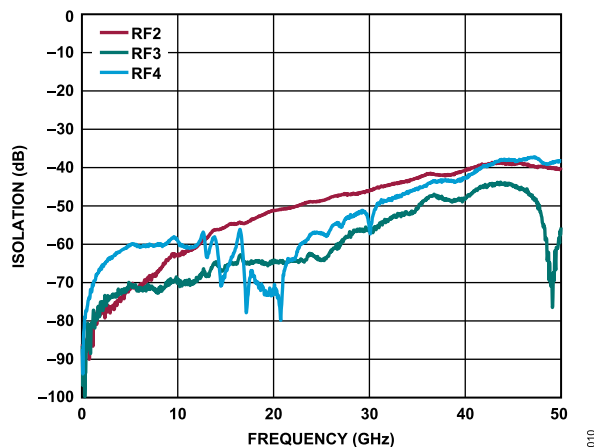

Figure 10. RFC to RF2, RF3, and RF4 Isolation vs. Frequency, RF1 Selected

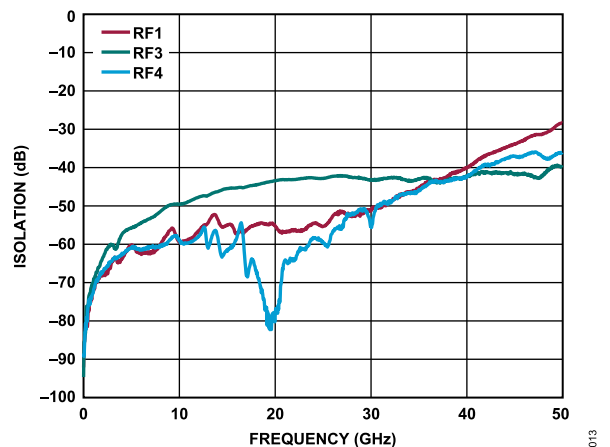

Figure 13. RFC to RF1, RF3, and RF4 Isolation vs. Frequency, RF2 Selected

TYPICAL PERFORMANCE CHARACTERISTICS

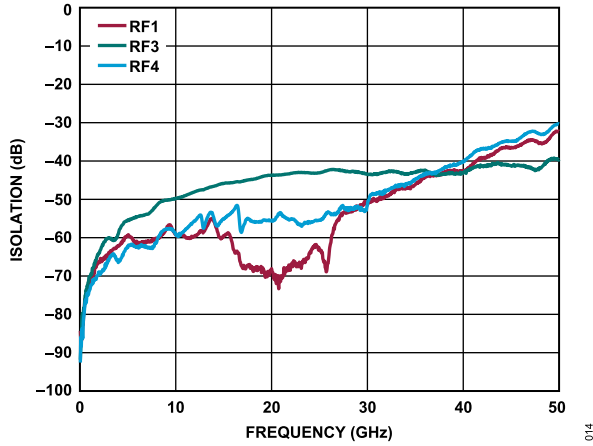

Figure 14. RFC to RF1, RF2, and RF4 Isolation vs. Frequency, RF3 Selected

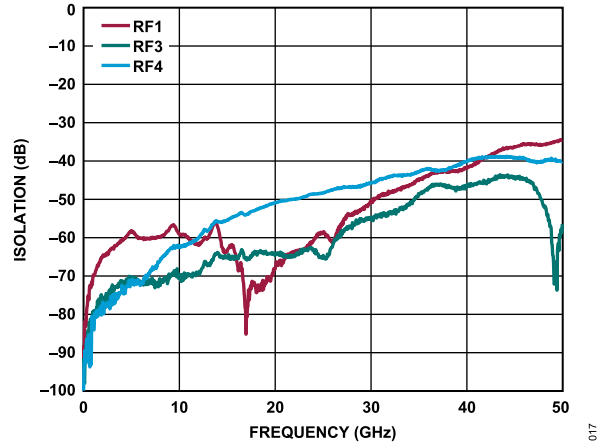

Figure 17. RFC to RF1, RF2, RF3 Isolation vs. Frequency, RF4 Selected

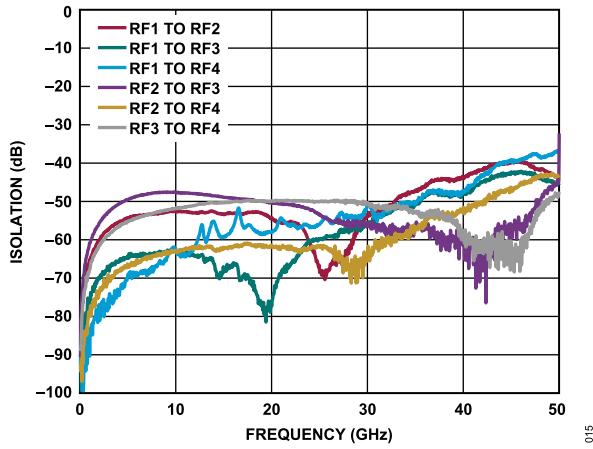

Figure 15. Channel to Channel Isolation vs. Frequency, RFC to RF1 Path Selected

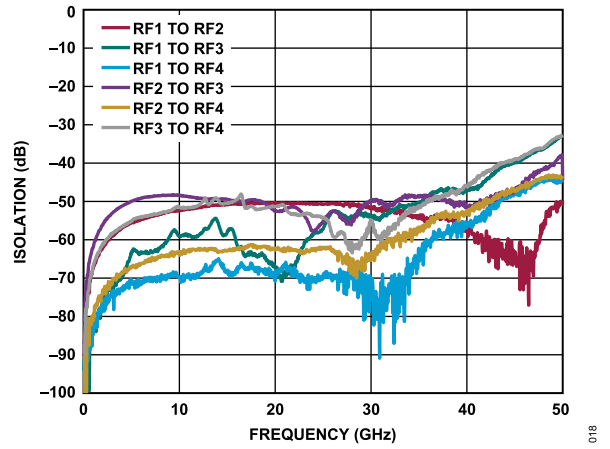

Figure 18. Channel to Channel Isolation vs. Frequency, RFC to RF2 Path Selected

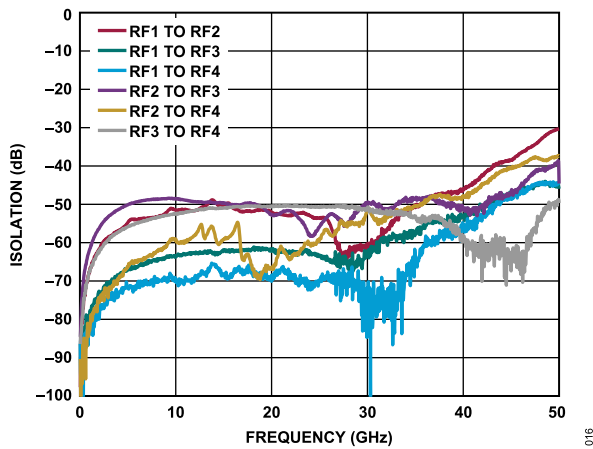

Figure 16. Channel to Channel Isolation vs. Frequency, RFC to RF3 Path Selected

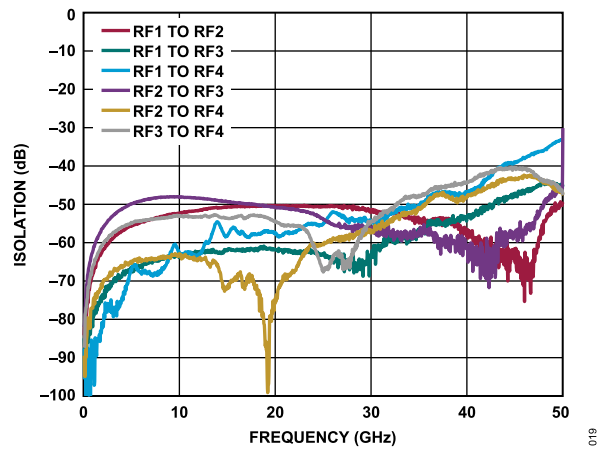

Figure 19. Channel to Channel Isolation vs. Frequency, RFC to RF4 Path Selected

TYPICAL PERFORMANCE CHARACTERISTICS

INPUT POWER COMPRESSION AND THIRD-ORDER INTERCEPT

$V_{DD} = 3.3\text{ V}$, $V_{SS} = -3.3\text{ V}$, $EN = 0\text{ V}$, $V_1 = 0\text{ V}$ or 3.3 V , $V_2 = 0\text{ V}$ or 3.3 V , $LS = 0\text{ V}$ or 3.3 V , and $T_{CASE} = 25^\circ\text{C}$ on a $50\ \Omega$ system, unless otherwise noted.

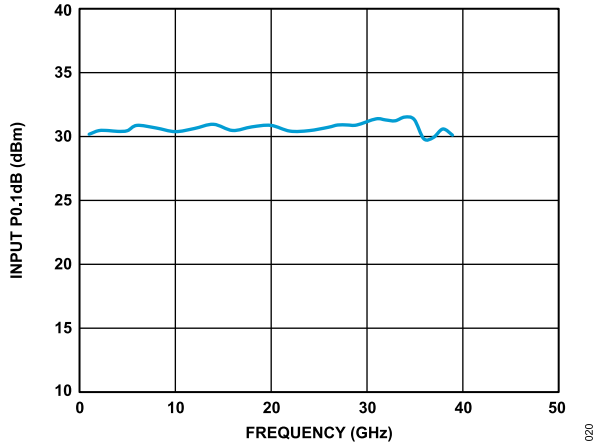

Figure 20. Input P0.1dB vs. Frequency

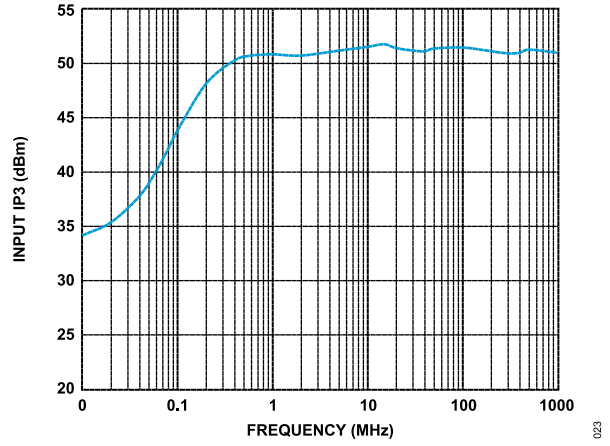

Figure 23. Input IP3 vs. Frequency, Low Frequency Detail

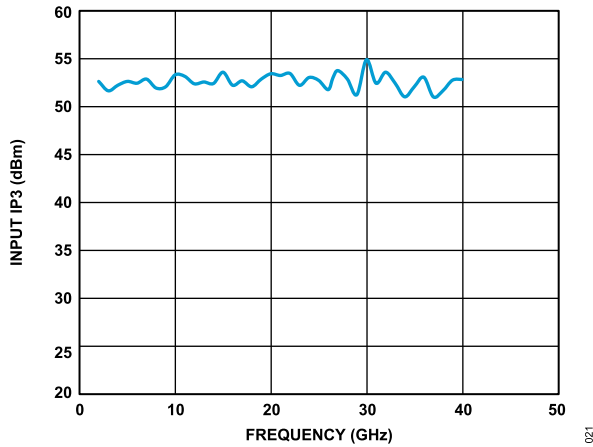

Figure 21. Input IP3 vs. Frequency

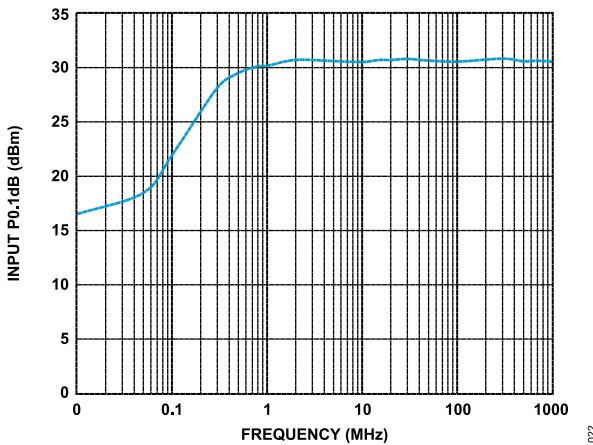

Figure 22. Input P0.1dB vs. Frequency, Low Frequency Detail

THEORY OF OPERATION

The ADRF5049 requires a positive supply voltage applied to the VDD pin and a negative supply voltage applied to the VSS pin. Bypassing capacitors are recommended on the supply lines to minimize RF coupling.

All of the RF ports (RFC, RF1 to RF4) are dc-coupled to 0 V, and no dc blocking is required at the RFx ports when the RF line potential is equal to 0 V. The RF ports are internally matched to 50 Ω . Therefore, external matching networks are not required.

The ADRF5049 integrates a driver to perform logic functions internally and to provide the user with the advantage of a simplified CMOS-/LVTTTL-compatible control interface. The driver features four digital control input pins (EN, LS, V1, and V2) that control the state of the RFx paths. See [Table 6](#).

The LS pin allows the user to define the control input logic sequence for the RF path selections. The logic level applied to the V1 and V2 pins determines which RFx port is in the insertion loss state while the other three paths are in the isolation state.

When the EN pin is logic high, all four RFx paths are in an isolation state regardless of the logic state of LS, V1, and V2. The RFx ports are terminated to internal 50 Ω resistors, and RFC becomes reflective.

The insertion loss path conducts the RF signal between the selected RF throw port and the RF common port. The switch design is

bidirectional with equal power handling capabilities. The RF input signal can be applied to the RFC port or the selected RF throw port. The isolation paths provide high loss between the insertion loss path and the unselected RF throw ports that are terminated to internal 50 Ω resistors.

The ideal power-up sequence is as follows:

1. Connect GND.
2. Power up VDD.
3. Apply the digital control inputs: EN, LS, V1, and V2. Applying digital control inputs before the VDD supply can inadvertently forward bias and damage the internal ESD protection structures. A series 1 k Ω resistor can be used to limit the current flowing into the digital control input pins in such cases. If the digital control input pins are not driven to a valid logic state (that is, the controller output is in high impedance state) after VDD is powered up, it is recommended to use pull-up and power-down resistors.
4. Apply an RF input signal.

The ideal power-down sequence is the reverse order of the power-up sequence.

Table 6. Control Voltage Truth Table

Digital Control Inputs				RFx Paths			
EN	LS	V1	V2	RF1 to RFC	RF2 to RFC	RF3 to RFC	RF4 to RFC
Low	Low	Low	Low	Insertion loss (on)	Isolation (off)	Isolation (off)	Isolation (off)
Low	Low	High	Low	Isolation (off)	Insertion loss (on)	Isolation (off)	Isolation (off)
Low	Low	Low	High	Isolation (off)	Isolation (off)	Insertion loss (on)	Isolation (off)
Low	Low	High	High	Isolation (off)	Isolation (off)	Isolation (off)	Insertion loss (on)
Low	High	Low	Low	Isolation (off)	Isolation (off)	Isolation (off)	Insertion loss (on)
Low	High	High	Low	Isolation (off)	Isolation (off)	Insertion loss (on)	Isolation (off)
Low	High	Low	High	Isolation (off)	Insertion loss (on)	Isolation (off)	Isolation (off)
Low	High	High	High	Insertion loss (on)	Isolation (off)	Isolation (off)	Isolation (off)
High	Low or high	Low or high	Low or high	Isolation (off)	Isolation (off)	Isolation (off)	Isolation (off)

APPLICATIONS INFORMATION

The ADRF5049 has two power supply pins (VDD and VSS) and four control pins (V1, V2, LS, and EN). Figure 24 shows the external components and connections for the supply and control pins. The VDD pin and the VSS pin are decoupled with 100 pF multilayer ceramic capacitor. The ADRF5049 pinout allows the placement of the decoupling capacitors close to the device. No other external components are needed for bias and operation, except DC blocking capacitors on the RFx pins when the RF lines are biased at a voltage different than 0 V. Refer to Pin Configuration and Function Descriptions section for further details.

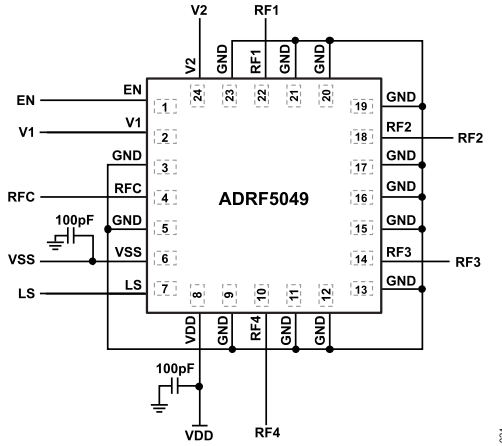

Figure 24. Recommended Schematic

RECOMMENDATIONS FOR PCB DESIGN

The RF ports are matched to 50 Ω internally and the pinout is designed to mate a coplanar waveguide (CPWG) with 50 Ω characteristic impedance on the PCB. Figure 25 shows the referenced CPWG RF trace design for an RF substrate with 8 mil thick Rogers RO4003 dielectric material. RF trace with 14 mil width and 7 mil clearance is recommended for 2.2 mil finished copper thickness.

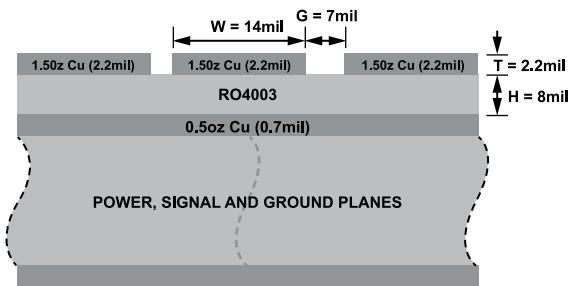

Figure 25. Example PCB Stack-Up

Figure 26 shows the routing of the RF traces, supply, and control signals from the ADRF5049. The ground planes are connected with as many filled, through vias as allowed for optimal RF and thermal performance. The primary thermal path for the ADRF5049 is the bottom side.

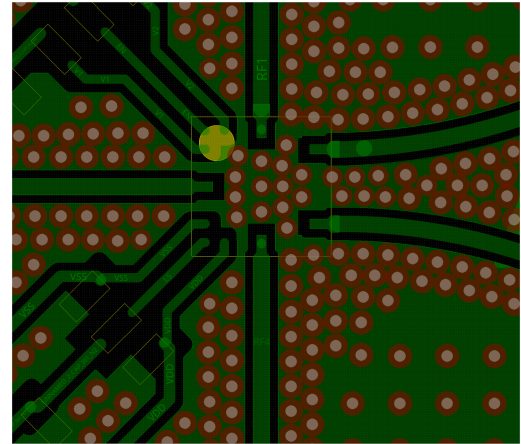

Figure 26. PCB Routings

Figure 27 shows the recommended layout from the device RFx pins to the 50 Ω CPWG on the referenced stack-up. PCB pads are drawn 1:1 to the device pads. The ground pads are drawn solder mask defined, and the signal pads are drawn as pad defined. The RF trace from the PCB pad is extended with the same width till the package edge and tapered to the RF trace with a 45° angle. The paste mask is also designed to match the pad without any aperture reduction. The paste is divided into multiple openings for the paddle.

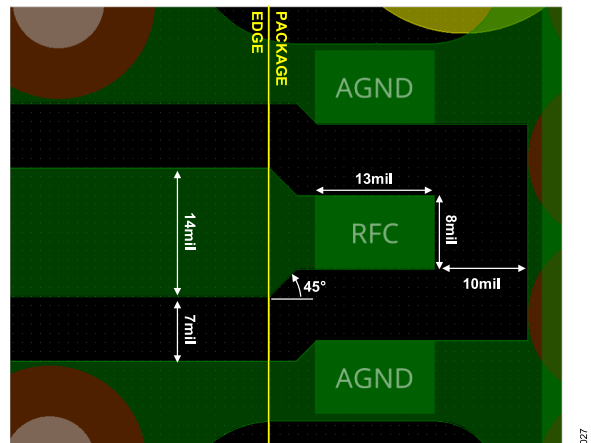

Figure 27. Recommended RF Pin Transitions

For alternate PCB stack-ups with different dielectric thickness and CPWG design, contact Analog Devices, Inc., Technical Support Request for further recommendations.

OUTLINE DIMENSIONS

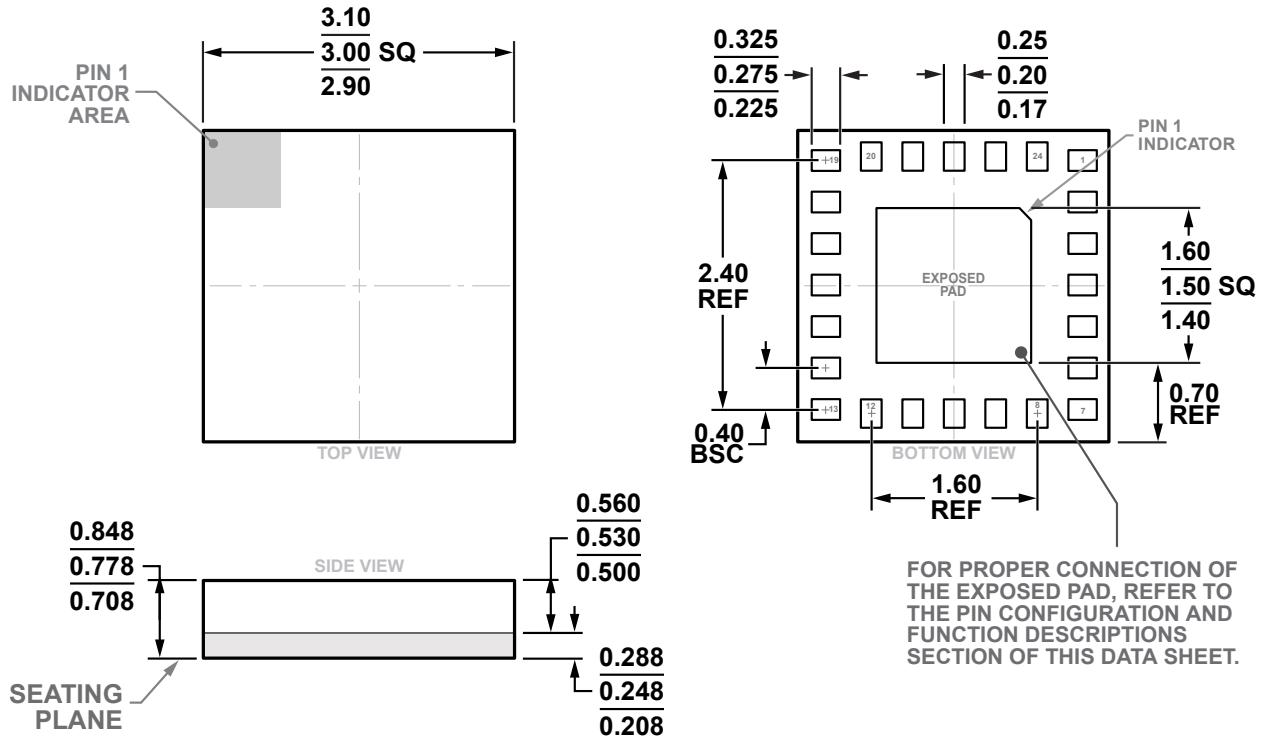

Figure 28. 24-Terminal Land Grid Array [LGA]
 3 mm x 3 mm Body and 0.780 mm Package Height
 (CC-24-14)
 Dimensions shown in millimeters

Updated: February 04, 2023

ORDERING GUIDE

Model ¹	Temperature Range	Package Description	Packing Quantity	Package Option
ADRF5049BCCZN	-40°C to +105°C	24-Terminal LGA (3 mm x 3 mm x 0.828 mm)	Reel, 500	CC-24-14
ADRF5049BCCZN-R7	-40°C to +105°C	24-Terminal LGA (3 mm x 3 mm x 0.828 mm)	Reel, 500	CC-24-14

¹ Z = RoHS Compliant Part.

EVALUATION BOARDS

Model ¹	Description
ADRF5049-EVALZ	Evaluation Board

¹ Z = RoHS Compliant Part.