

EM-1711

Shipped in packet-tape reel(5000pcs/Reel)

EM-1711 is ultra-small Hall effect ICs of a single silicon chip composed of Hall element and a signal processing IC.

Bipolar Hall Effect Latch	Supply Voltage 1.6~5.5V	Power down Function	Ultra High Sensitivity Bop:1.8mT	Output CMOS	SMT
---------------------------	-------------------------	---------------------	----------------------------------	-------------	-----

Notice:It is requested to read and accept "IMPORTANT NOTICE" written on the back of the front cover of this catalogue.

●Operational Characteristics

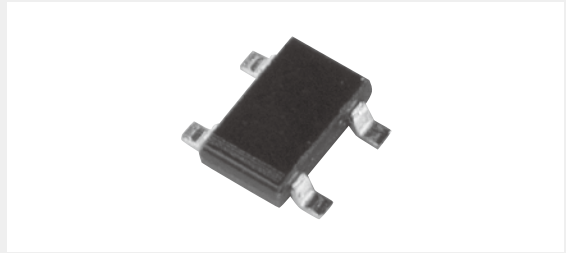
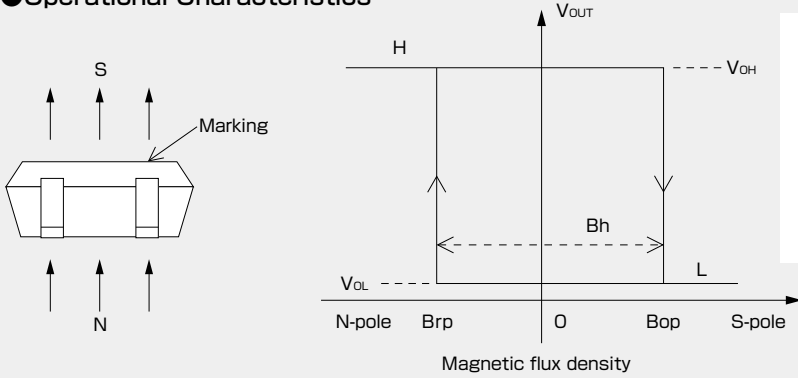

●Absolute Maximum Ratings (Ta=25°C)

Item	Symbol	Min.	Max.	Unit
Supply Voltage	V _{DD}	-0.1	6.0	V
PDN input voltage	V _{IN}	-0.1	V _{DD} +0.1	V
PDN input current	I _{IN}	-10	+10	mA
Output Current	I _{OUT}	-0.5	+0.5	mA
Storage Temperature Range	T _{STG}	-40	+125	°C

●Functional Block Diagram

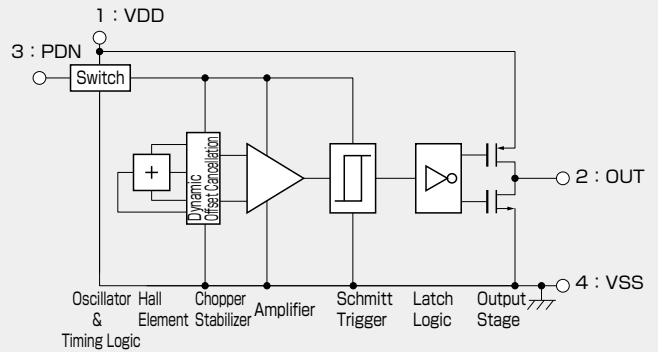

●Recommended Operating Conditions

Item	Symbol	Min.	Typ.	Max.	Unit
Supply Voltage	V _{DD}	1.6	3.0	5.5	V
Operating Temperature Range	T _{opr}	-30	+25	+85	°C

●Magnetic Characteristics ② (Ta=-30~+85°C V_{DD}=3.0V)

Parameter	Symbol	Conditions	Min.	Typ.	Max.	Unit
Operating Point	B _{op}			1.8	4.2	mT
Releasing Point	B _{rp}		-4.2	-1.8		mT
Hysteresis	B _h			3.6		mT

Note) The above specifications are design targets.

●Magnetic ① and Electrical Characteristics (Ta=25°C V_{DD}=3.0V)

Item	Symbol	Conditions	Min.	Typ.	Max.	Unit
Operating Point *1	B _{op}			1.8	4.0	mT
Releasing Point *1	B _{rp}		-4.0	-1.8		mT
Hysteresis	B _h			3.6		mT
PDN input High voltage	V _{IH}		0.7V _{DD}			V
PDN input Low voltage	V _{IL}				0.3	V
Output High Voltage	V _{OH}	I _o =-0.5mA	V _{DD} -0.4			V
Output Low Voltage	V _{OL}	I _o =+0.5mA			0.4	V
Supply Current1*2	I _{DD1}	PDN=L			1	μA
Supply Current2*2	I _{DD2}	PDN=H		2.5	6	mA
PDN input Current	I _{IN}		-1		1	μA
PDN mode transition time1	T _{PD1}	Active→PDN			100	μs
PDN mode transition time2	T _{PD2}	PDN→Active			100	μs

1 [mT]=10 [Gauss]

*1: Positive(+) polarity flux is defined as the magnetic flux from south pole which is direct toward to the branded face of the sensor (Bop, Brp)
 *2: In case of PDN pin is held at VDD or GND.

•Please be aware that our products are not intended for use in life support equipment, devices, or systems. Use of our products in such applications requires the advance written approval of our sales staff.
 Certain applications using semiconductor devices may involve potential risks of personal injury, property damage or loss of life. In order to minimize these risks, adequate design and operating safeguards should be provided by the customer to minimize inherent or procedural hazards. Inclusion of our products in such applications is understood to be fully at the risk of the customer using our devices or systems.

●Package (Unit:mm)

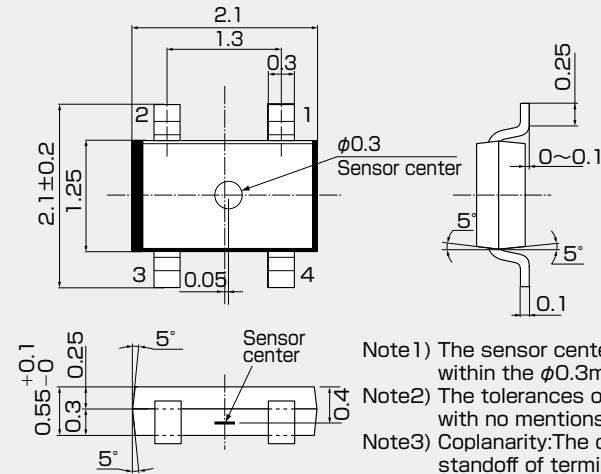

Pin No.	Pin Name	Function
1	VDD	Power Supply
2	OUT	Output
3	PDN	Power Down
4	VSS	Ground

- Note 1) The sensor center is located within the $\phi 0.3$ mm circle.
- Note 2) The tolerances of dimensions with no mentions is ± 0.1 mm.
- Note 3) Coplanarity: The differences between standoff of terminals are max. 0.1mm.
- Note 4) The sensor part is located 0.4mm (typ.) far from marking surface.

●(For reference only) Land Pattern

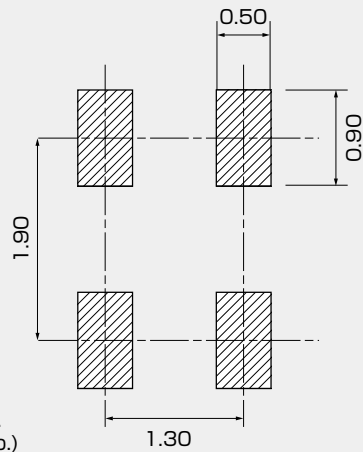

●Function Timing Chart

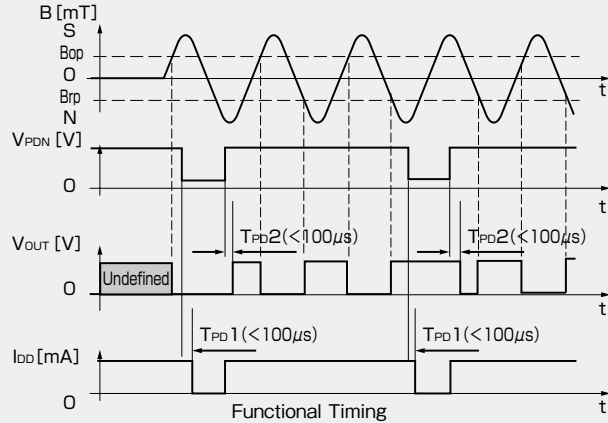

- Note 1) During power down mode, output is latched in its previous state.
- Note 2) When VDD is supplied, the time from reaching $V_{DD}=1.6$ V to the update of the output state is equal to T_{PD2} .

●Supply Voltage

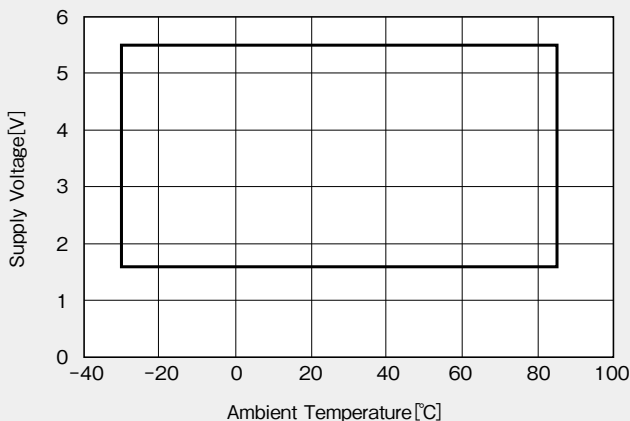

●Application Circuit

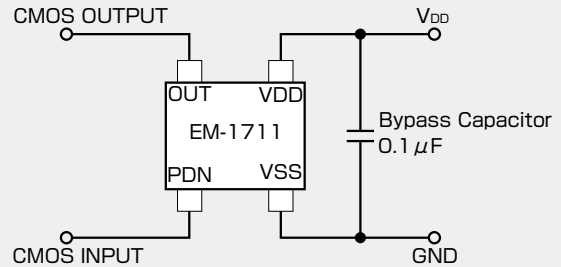

●Temperature Dependence of Bop, Brp

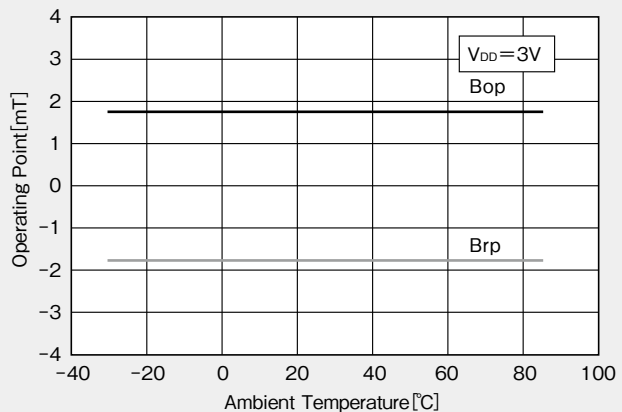

IMPORTANT NOTICE

0. Asahi Kasei Microdevices Corporation (“AKM”) reserves the right to make changes to the information contained in this document without notice. When you consider any use or application of AKM product stipulated in this document (“Product”), please make inquiries the sales office of AKM or authorized distributors as to current status of the Products.
1. All information included in this document are provided only to illustrate the operation and application examples of AKM Products. AKM neither makes warranties or representations with respect to the accuracy or completeness of the information contained in this document nor grants any license to any intellectual property rights or any other rights of AKM or any third party with respect to the information in this document. You are fully responsible for use of such information contained in this document in your product design or applications. **AKM ASSUMES NO LIABILITY FOR ANY LOSSES INCURRED BY YOU OR THIRD PARTIES ARISING FROM THE USE OF SUCH INFORMATION IN YOUR PRODUCT DESIGN OR APPLICATIONS.**
2. The Product is neither intended nor warranted for use in equipment or systems that require extraordinarily high levels of quality and/or reliability and/or a malfunction or failure of which may cause loss of human life, bodily injury, serious property damage or serious public impact, including but not limited to, equipment used in nuclear facilities, equipment used in the aerospace industry, medical equipment, equipment used for automobiles, trains, ships and other transportation, traffic signaling equipment, equipment used to control combustions or explosions, safety devices, elevators and escalators, devices related to electric power, and equipment used in finance-related fields. Do not use Product for the above use unless specifically agreed by AKM in writing.
3. Though AKM works continually to improve the Product’s quality and reliability, you are responsible for complying with safety standards and for providing adequate designs and safeguards for your hardware, software and systems which minimize risk and avoid situations in which a malfunction or failure of the Product could cause loss of human life, bodily injury or damage to property, including data loss or corruption.
4. Do not use or otherwise make available the Product or related technology or any information contained in this document for any military purposes, including without limitation, for the design, development, use, stockpiling or manufacturing of nuclear, chemical, or biological weapons or missile technology products (mass destruction weapons). When exporting the Products or related technology or any information contained in this document, you should comply with the applicable export control laws and regulations and follow the procedures required by such laws and regulations. The Products and related technology may not be used for or incorporated into any products or systems whose manufacture, use, or sale is prohibited under any applicable domestic or foreign laws or regulations.
5. Please contact AKM sales representative for details as to environmental matters such as the RoHS compatibility of the Product. Please use the Product in compliance with all applicable laws and regulations that regulate the inclusion or use of controlled substances, including without limitation, the EU RoHS Directive. AKM assumes no liability for damages or losses occurring as a result of noncompliance with applicable laws and regulations.
6. Resale of the Product with provisions different from the statement and/or technical features set forth in this document shall immediately void any warranty granted by AKM for the Product and shall not create or extend in any manner whatsoever, any liability of AKM.
7. This document may not be reproduced or duplicated, in any form, in whole or in part, without prior written consent of AKM.