

IEC Appliance Inlet C14 with Filter, Fuseholder 1- or 2-pole (5x20 mm or 6.3x32 mm), Line Switch 1- or 2-pole, Voltage Selector (Series-Parallel)



See below:
[Approvals and Compliances](#)

Description

- Panel mount :
Screw-on mounting from front side
- 5 Functions :
Appliance Inlet , Line Switch , Fuseholder with interchangeable fuse drawer for Fuse-links 5x20 mm or 6.3x32 mm , Voltage Selector (series-parallel) , Line filter in standard and medical version
- Quick connect terminals 4.8 x 0.8 mm

Characteristics

- All single elements are already partially wired
- For added safety "Extra-Safe" fuse drawers are available
- Suitable for use in equipment according to IEC/UL 60950
Suitable for use in medical equipment according to IEC/UL 60601-1

References

Alternative: version without line filter [KG](#)
 Alternative: Standard version

Weblinks

[pdf data sheet](#), [html datasheet](#), [General Product Information](#), [Distributor-Stock-Check](#), [Accessories](#), [Detailed request for product](#), [Landing Page](#)

Newly available variants corresponding to V-Lock mating cordset. The connector is equipped with a notch intended for use with the latching cordset. The cord latching system prevents against accidental removal of the cordset.

Technical Data

Ratings IEC	1 - 10A @ Ta 40 °C / 250 VAC; 50Hz	appliance inlet/-outlet	C14 acc. to IEC 60320-1, UL 498, CSA C22.2 no. 42 (for cold conditions) pin-temperature 70 °C, 10A, Protection Class I
Ratings UL/CSA	1 - 10A @ Ta 40 °C / 250 VAC; 60Hz	Fuseholder	1 or 2 pole, Shocksafe category PC2 acc. to IEC 60127-6, for fuse-links 5 x 20 or 6.3 x 32mm
Leakage Current	standard < 0.5mA (250V / 60Hz) medical < 5 µA (250 V / 60 Hz)	Rated Power Acceptance @ Ta 23 °C	5 x 20: 2.5W (1 pole)/ 2W (2-pole) per pole 6.3 x 32: 3.15W (1 pole)/ 2.5W (2-pole) per pole
Dielectric Strength	> 1.7kVDC between L-N > 2.7kVDC between L/N-PE Test voltage (2 sec)	Power Acceptance @ Ta > 23°C	Admissible power acceptance at higher ambient temperature see derating curves
Allowable Operation Temperature	-25 °C to 85 °C	Line Switch	2-pole, non-illuminated, acc. to IEC 61058-1 Technical Details
Climatic Category	25/085/21 acc. to IEC 60068-1	Voltage Selector	series-parallel, 4, 3 or 2 switch positions or usable as 2-pole change-over switch
IP-Protection	from front side IP40 acc. to IEC 60529	Line Filter	Standard and Medical Version, IEC 60939, UL 1283, CSA C22.2 no. 8 Technical Details
Protection Class	Suitable for appliances with protection class I acc. to IEC 61140	MTBF	> 1'100'000h acc. to MIL-HB-217 F
Terminal	Quick connect terminals 4.8 x 0.8 mm		
Panel Thickness S	Screw: max 8 mm Mounting screw torque max 0.5Nm		
Material: Housing	Thermoplastic, black, UL 94V-0		

Approvals and Compliances



Detailed information on product approvals, code requirements, usage instructions and detailed test conditions can be looked up in [Details about Approvals](#)

SCHURTER products are designed for use in industrial environments. They have approvals from independent testing bodies according to national and international standards. Products with specific characteristics and requirements such as required in the automotive sector according to IATF 16949, medical technology according to ISO 13485 or in the aerospace industry can be offered exclusively with customer-specific, individual agreements by SCHURTER.

Approvals









The approval mark is used by the testing authorities to certify compliance with the safety requirements placed on electronic products.

Approval Reference Type: CG

Approval Logo	Certificates	Certification Body	Description
	VDE Approvals	VDE	Certificate Number: 40004665 (FKSA, FKSB)
	UL Approvals	UL	UL File Number: E72928 (FKSA, FKSB)



Product standards

Product standards that are referenced

Organization	Design	Standard	Description
	Designed according to	IEC 60320-1	Appliance couplers for household and similar general purposes
	Designed according to	IEC 60939	Passive filters for suppressing electromagnetic interference
	Designed according to	IEC 60127-6	Miniature fuses. Part 6. Fuse-holders for miniature fuse-links
	Designed according to	IEC 61058-1	Switches for appliances. Part 1. General requirements
	Designed according to	UL 498	Standard for Attachment Plugs and Receptacles
	Designed according to	UL 1283	Electromagnetic interference filters
	Designed according to	CSA C22.2 no. 42	General Use Receptacles, Attachment Plugs, and Similar Wiring Devices
	Designed according to	CSA C22.2 no. 8	Electromagnetic interference (EMI) filters







Application standards

Application standards where the product can be used

Organization	Design	Standard	Description
	Designed for applications acc.	IEC/UL 60950	IEC 60950-1 includes the basic requirements for the safety of information technology equipment.
	Designed for applications acc.	IEC 60601-1	Medical electrical equipment - Part 1: General requirements for basic safety and essential performance
	Designed for applications acc.	IEC 60335-1	Safety of electrical appliances for household and similar purposes. Meets the requirements for appliances in unattended use. This includes the enhanced requirements of glow wire tests acc. to IEC 60695-2-11 or -12 & -13.

Compliances

The product complies with following Guide Lines

Identification	Details	Initiator	Description
	CE declaration of conformity	SCHURTER AG	The CE marking declares that the product complies with the applicable requirements laid down in the harmonisation of Community legislation on its affixing in accordance with EU Regulation 765/2008.
	RoHS	SCHURTER AG	Directive RoHS 2011/65/EU, Amendment (EU) 2015/836
	China RoHS	SCHURTER AG	The law SJ / T 11363-2006 (China RoHS) has been in force since 1 March 2007. It is similar to the EU directive RoHS.
	REACH	SCHURTER AG	On 1 June 2007, Regulation (EC) No 1907/2006 on the Registration, Evaluation, Authorization and Restriction of Chemicals 1 (abbreviated as "REACH") entered into force.
		SCHURTER AG	V-Lock system are based on a matching plug-dose combination. The connector is equipped with a notch intended for use with the latching cordset. The cord latching system prevents against accidental removal of the cordset.
	White paper Glow wire test	SCHURTER AG	Meets the requirements of IEC 60335-1 for appliances in unattended use. This includes the enhanced requirements of glow wire tests acc. to IEC 60695-2-11 or -12 & -13.
	Medical Technology	SCHURTER AG	Suitable for use in medical equipment according to IEC/UL 60601-1

Dimension [mm]
 CG

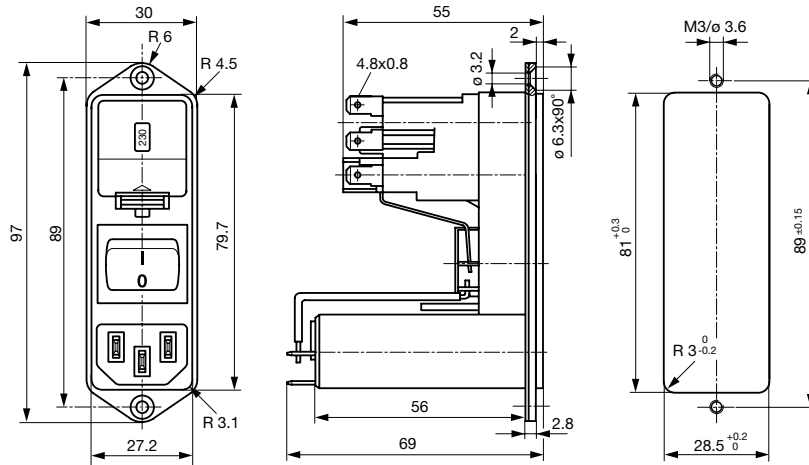

Technical Data of Filter-Components

Rated Current [A]	Filter-Type	Inductances L [mH]	Capacitance CX [nF]	Capacitance CY [nF]	R [MΩ]
1	Standard Version	2 x 10	68	2.2	-
2	Standard Version	2 x 4	68	2.2	-
4	Standard Version	2 x 1.5	68	2.2	-
6	Standard Version	2 x 0.8	68	2.2	-
10	Standard Version	2 x 0.3	68	2.2	-
1	Medical Version (M5)	2 x 10	68	-	1
2	Medical Version (M5)	2 x 4	68	-	1
4	Medical Version (M5)	2 x 1.5	68	-	1
6	Medical Version (M5)	2 x 0.8	68	-	1
10	Medical Version (M5)	2 x 0.3	68	-	1

Diagrams

Standard version
 with fuseholder 1- or 2-pole

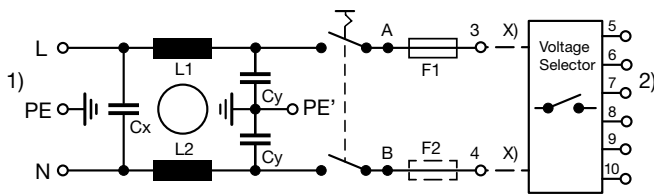

Medical version (M5)
 with 2-pole fuseholder

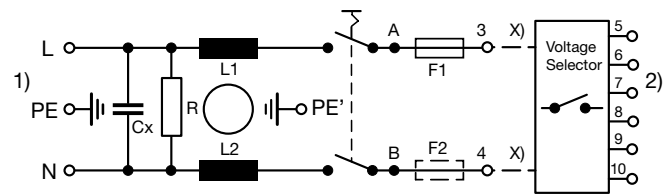

x) external connection to be made by the customer

x) external connection to be made by the customer

- 1) Line
- 2) Load

- 1) Line
- 2) Load

Derating Curves

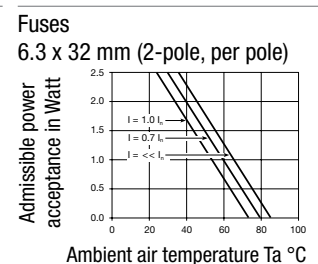
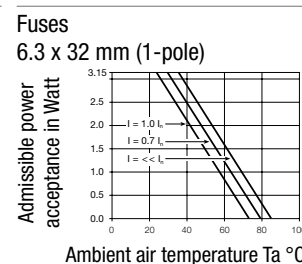
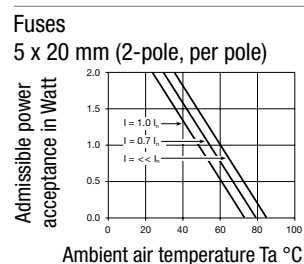
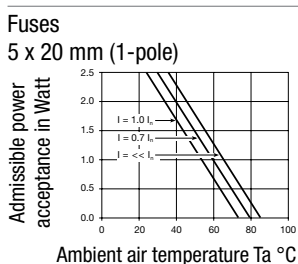

Attenuation Loss

--- 50Ω differential mode ____ 50Ω common mode

Standard version

1 A

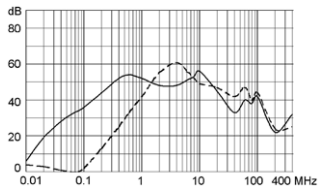

2 A

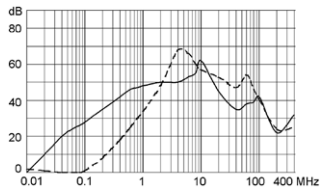

4 A

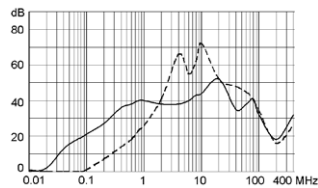

6 A

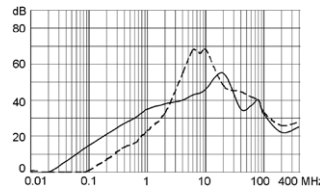

10 A

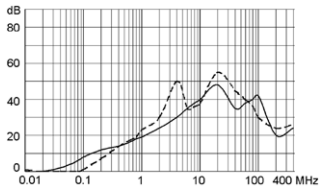

Medical version (M5)

1 A

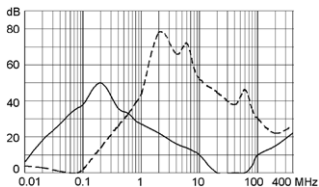

2 A

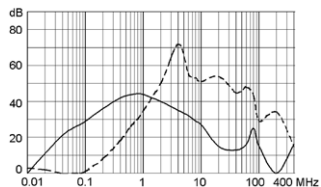

4 A

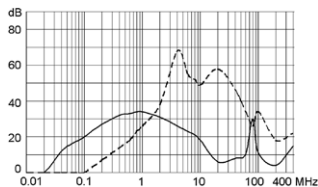

6 A

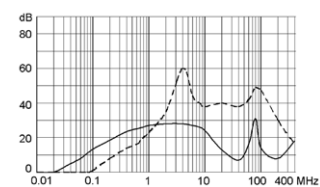

10 A

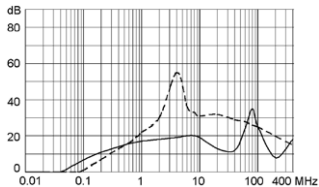

All Variants

Type	Rated Current [A]	Filter-Type	Fuseholder	Line Switch	Line Switch	Order Number
CG	1	Standard Version	1-pole	2-pole	-	CG16.5101.151
CG	2	Standard Version	1-pole	2-pole	-	CG26.5101.151
CG	4	Standard Version	1-pole	2-pole	-	CG36.5101.151
CG	6	Standard Version	1-pole	2-pole	-	CG46.5101.151
CG	10	Standard Version	1-pole	2-pole	-	CG66.5101.151
CG	1	Standard Version	2-pole	2-pole	-	CG10.6101.151
CG	2	Standard Version	2-pole	2-pole	-	CG20.6101.151
CG	4	Standard Version	2-pole	2-pole	-	CG30.6101.151
CG	6	Standard Version	2-pole	2-pole	-	CG40.6101.151
CG	10	Standard Version	2-pole	2-pole	-	CG60.6101.151
CG	1	Medical Version (M5)	2-pole	2-pole	-	CGG0.6101.151
CG	2	Medical Version (M5)	2-pole	2-pole	-	CGA0.6101.151
CG	4	Medical Version (M5)	2-pole	2-pole	-	CGC0.6101.151
CG	6	Medical Version (M5)	2-pole	2-pole	-	CGE0.6101.151
CG	10	Medical Version (M5)	2-pole	2-pole	-	CGL0.6101.151

Type	Rated Current [A]	Filter-Type	Fuseholder	Line Switch	Line Switch	Order Number
------	-------------------	-------------	------------	-------------	-------------	--------------

Most Popular.

Availability for all products can be searched real-time: <https://www.schurter.com/en/Stock-Check/Stock-Check-SCHURTER>

Suffix ".21" corresponds to the version with V-Lock mating cordset. The connector is equipped with a notch intended for use with the latching cordset. The cord latching system prevents against accidental removal of the cordset.

Packaging unit 5 Pcs

Required Accessory

Description

Fusedrawer 1

Fusedrawer for Fuse Links 5x20 mm resp. 6.3x32 mm



5 x 20, 2-pole	4305.0001
5 x 20, 1-pole	4305.0006
6.3 x 32, 2-pole	4305.0011
6.3 x 32, 1-pole	4305.0016
...	...

Jumper Wire 1

Connection with Stranded Cable



Type A, 70 mm	0881.0074
Type A, 100 mm	0881.0075
Type B, 70 mm	0881.0076
Type B, 100 mm	0881.0077

Voltage Selectors Insert 1

Voltage Selector Insert to KE, CE, KG, CG



3 or 4 switch positions	4305.0048.00
1, 3 or 4 switch positions, 100, 120, 220, 240	4305.0048.01
3, 3 or 4 switch positions, 130, 110, 240, 220	4305.0048.02
2, 2 switch positions, 110, 220	4305.0048.03
...	...

Accessories

Assorted Covers

Rear Cover



0859.0109

Cord retaining kits

Cord retaining strain relief



Flat head, A	4700.0001
--------------	-----------

Mating Outlets/Connectors

Category / Description

[Appliance Outlet Overview complete](#)



4787, Mounting: Screw-on mounting, Appliance Outlet: IEC Solder terminals, 10 A, Suitable for appliances with protection class I	4787
4788, Mounting: Snap-in version, Appliance Outlet: IEC Solder terminals or quick connect terminals, 10 A, Suitable for appliances with protection class I	4788
IEC Appliance Outlet F or H, Screw-on Mounting, Front Side, Solder, PCB or Quick-connect Terminal	5091

[Appliance Outlet further types to CG](#)

[Connector Overview complete](#)



4022 Mounting: Power Supply Cord, 3 x 1.5 mm ² , Screw clamps, Connector: IEC C13	4022
4782 Mounting: Power Cord, 3 x 1 mm ² / 3 x 18 AWG, Cable, Connector: IEC C13	4782
4012 Mounting: Power Supply Cord, 3 x 1 mm ² , Screw clamps, Connector: IEC C13	4012
4785 Mounting: Power Cord, 3 x 1 mm ² / 3 x 18 AWG, Cable, Connector: IEC C13	4785
4300-06 Mounting: Power Cord, 3 x 1 mm ² / 3 x 18 AWG, Cable, Connector: IEC C13	4300-06

[Connector further types to CG](#)

...

Mating Outlets/Connectors shuttered

[Power Cord Overview complete](#)



VAC13KS, Overview, V-Lock cord retaining, diverse Connector IEC C13, diverse, black	VAC13KS
---	---------

[Power Cord further types to CG](#)