

CMOS HEX VOLTAGE-LEVEL SHIFTER FOR TTL-TO-CMOS or CMOS-TO-CMOS OPERATION

FEATURES

- Independence of Power-Supply Sequence Considerations – V_{CC} Can Exceed V_{DD} ; Input Signals Can Exceed Both V_{CC} and V_{DD}
- Up and Down Level-Shifting Capability
- Shiftable Input Threshold for Either CMOS or TTL Compatibility
- Standardized Symmetrical Output Characteristics
- 100% Tested for Quiescent Current at 20 V
- Maximum Input Current of 1 μ A at 18 V Over Full Package-Temperature Range: 100 nA at 18 V and 25°C
- 5 V, 10 V, and 15 V Parametric Ratings
- Meets All Requirements of JEDEC Standard No. 13B, "Standard Specifications for Description of 'B' Series CMOS Devices"

SUPPORTS DEFENSE, AEROSPACE, AND MEDICAL APPLICATIONS

- Controlled Baseline
- One Assembly/Test Site
- One Fabrication Site
- Available in Military (–55°C/125°C) Temperature Range⁽¹⁾
- Extended Product Life Cycle
- Extended Product-Change Notification
- Product Traceability

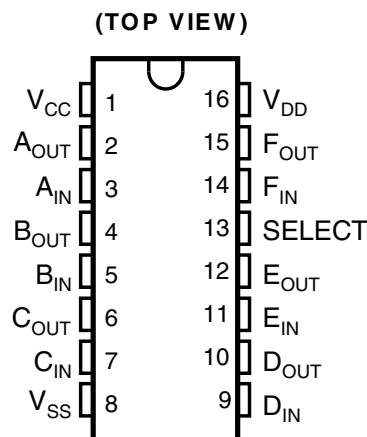

(1) Additional temperature ranges are available – contact factory

DESCRIPTION

CD4504B hex voltage level-shifter consists of six circuits which shift input signals from the V_{CC} logic level to the V_{DD} logic level. To shift TTL signals to CMOS logic levels, the SELECT input is at the V_{CC} HIGH logic state. When the SELECT input is at a LOW logic state, each circuit translates signals from one CMOS level to another.

ORDERING INFORMATION⁽¹⁾

T_A	PACKAGE ⁽²⁾		ORDERABLE PART NUMBER	TOP-SIDE MARKING
–55°C to 125°C	TSSOP – PW	Reel of 2000	CD4504BMPWREP	4504BEP

(1) Package drawings, thermal data, and symbolization are available at www.ti.com/packaging.

(2) For the most current package and ordering information, see the Package Option Addendum at the end of this document, or see the TI website at www.ti.com.



Please be aware that an important notice concerning availability, standard warranty, and use in critical applications of Texas Instruments semiconductor products and disclaimers thereto appears at the end of this data sheet.

FUNCTIONAL BLOCK DIAGRAM

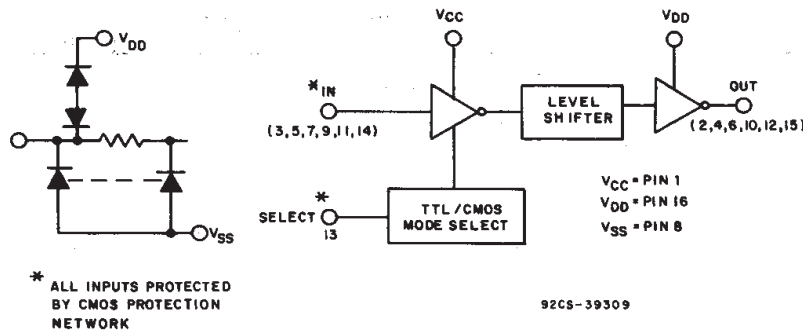

ABSOLUTE MAXIMUM RATINGS

over operating free-air temperature range (unless otherwise noted)

		MIN	MAX	UNIT	
V_{DD}	DC supply-voltage range, voltages referenced to V_{SS} terminal	-0.5	+20	V	
	Input voltage range, all inputs	-0.5	$V_{CC} + 0.5$	V	
	DC input current, any one input		± 10	mA	
P_D	Power dissipation per package	$T_A = -55^\circ\text{C to } +100^\circ\text{C}$		500	mW
		$T_A = +100^\circ\text{C to } +125^\circ\text{C}$		Derate Linearly at 12 mW/°C to 200 nW	
	Device dissipation per output transistor, for $T_A =$ full package-temperature range (all package types)		100	mW	
T_A	Operating temperature range	-55	+125	°C	
θ_{JA}	Package thermal impedance ⁽¹⁾		91.1	°C/W	
T_{stg}	Storage temperature range	-85	+150	°C	
	Lead temperature (during soldering), at distance $1/16 \pm 1/32$ inch (1.59 ± 0.79 mm) from case for 10 s max		+265	°C	

(1) The package thermal impedance is calculated in accordance with JESD 51-7.

STATIC ELECTRICAL CHARACTERISTICS

over operating free-air temperature range (unless otherwise noted)

CHARACTERISTIC	CONDITIONS				LIMITS AT INDICATED TEMPERATURES (°C)							UNIT
	V _O (V)	V _{IN} (V)	V _{CC} (V)	V _{CC} (V)	-55	-40	+85	+125	+25			
									MIN	TYP	MAX	
Quiescent device current, I _{DD} max and I _{CC} in CMOS-CMOS mode		0, 5	5	5	1.5	1.5	1.5	1.5		0.02	1.5	mA
		0, 10	5	10	2	2	2	2		0.02	2	
		0, 15	5	15	4	4	120	120		0.02	4	μA
		0, 20	5	20	20	20	600	600		0.04	20	
Quiescent device current, I _{CC} max TTL-CMOS mode		0, 5	5	5	5	5	6	6		2.5	5	mA
		0, 10	5	10	5	5	6	6		2.5	5	
		0, 15	5	15	5	5	6	6		2.5	5	
Output low (sink) current, I _{OL} min	0.4	0, 5		5	0.64	0.61	0.42	0.36	0.51	1		mA
	0.5	0, 10		10	1.6	1.5	1.1	0.9	1.3	2.6		
	1.5	0, 15		15	4.2	4	2.8	2.4	3.4	6.8		
Output high (source) current, I _{OH} min	4.6	0, 5		5	-0.64	-0.61	-0.42	-0.36	-0.51	-1		mA
	2.5	0, 5		5	-2	-1.8	-1.3	-1.15	-1.6	-3.2		
	9.5	0, 10		10	-1.6	-1.5	-1.1	-0.9	-1.3	-2.6		
	13.5	0, 15		15	-4.2	-4	-2.8	-2.4	-3.4	-6.8		
Output voltage: low-level, V _{OL} max		0, 5		5	0.05					0	0.05	V
		0, 10		10	0.05					0	0.05	
		0, 15		15	0.05					0	0.05	
Output voltage: high-level, V _{OH} min		0, 5		5	4.95				4.95	5		V
		0, 10		10	9.95				9.95	10		
		0, 15		15	14.95				14.95	15		
Input low voltage, V _{IL} max ⁽¹⁾	TTL-CMOS	1		5	10	0.8					0.8	V
	TTL-CMOS	1		5	15	0.8					0.8	
	CMOS-CMOS	1		5	10	1.5					1.5	
	CMOS-CMOS	1.5		5	15	1.5					1.5	
	CMOS-CMOS	1.5		10	15	3					3	
Input high voltage, V _{IH} min ⁽¹⁾	TTL-CMOS	9		5	10	2				2		V
	TTL-CMOS	13.5		5	15	2				2		
	CMOS-CMOS	9		5	10	3.5				3.5		
	CMOS-CMOS	13.5		5	15	3.5				3.5		
	CMOS-CMOS	13.5		10	15	7				7		
Input current, I _{IN} max		0, 18		18	±0.1	±0.1	±1	±1		±10 ⁻⁵	±0.1	μA

(1) Applies to the six input signals. For mode control (P13), only the CMOS-CMOS ratings apply.

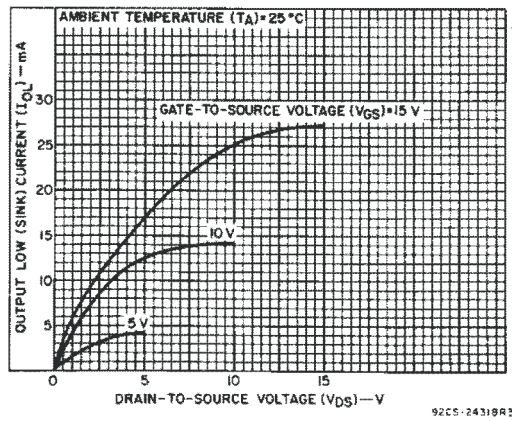

Figure 1. Typical Output Low (sink) Current Characteristics

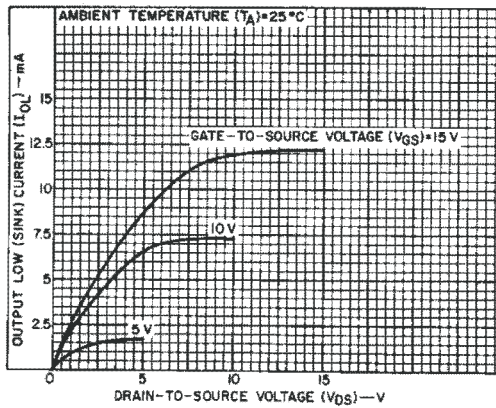

Figure 2. Minimum Output Low (sink) Current Characteristics

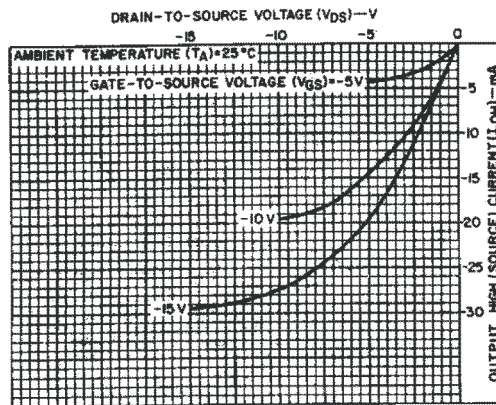

Figure 3. Typical Output High (source) Current Characteristics

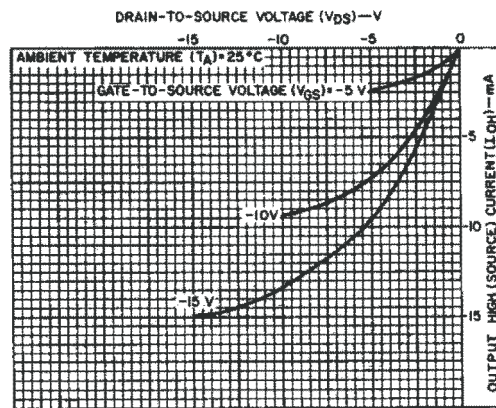

Figure 4. Minimum Output High (source) Current Characteristics

RECOMMENDED OPERATING CONDITIONS

For maximum reliability, nominal operating conditions should be selected so that operation is always within the following ranges:

CHARACTERISTIC		MIN	MAX	UNIT
V_{DD}	Supply-voltage range (for T_A = full package temperature range)	5	18	V

DYNAMIC ELECTRICAL CHARACTERISTICS

$T_A = 25^\circ\text{C}$, Input $t_r, t_f = 20\text{ ns}$, $C_L = 50\text{ pF}$, $R_L = 200\ \Omega$

CHARACTERISTIC	SHIFTING MODE	V_{CC} (V)	V_{DD} (V)	LIMITS		UNIT		
				TYP	MAX			
t_{PHL} Propagation delay: high-to-low,	TTL to CMOS $V_{DD} > V_{CC}$	5	10	140	280	ns		
		5	15	140	280			
	CMOS to CMOS $V_{DD} > V_{CC}$	5	10	120	240			
		5	15	120	240			
	CMOS to CMOS $V_{CC} > V_{DD}$	10	15	70	140			
		10	5	275	550			
		15	5	275	550			
	t_{PLH} Propagation delay: low-to-high	TTL to CMOS $V_{DD} > V_{CC}$	5	10	140		280	ns
			5	15	140		280	
CMOS to CMOS $V_{DD} > V_{CC}$		5	10	120	240			
		5	15	120	240			
CMOS to CMOS $V_{CC} > V_{DD}$		10	15	70	140			
		10	5	200	400			
		15	5	200	400			
t_{THL}, t_{TLH} Transition time		All modes		5	100	200	ns	
				10	50	100		
	15			40	80			
C_{IN} Input capacitance	Any input			5	7.5	pF		

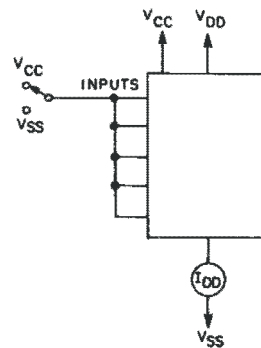

Figure 5. Quiescent Device Current

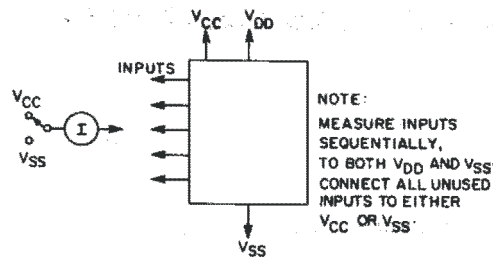

Figure 6. Input Current

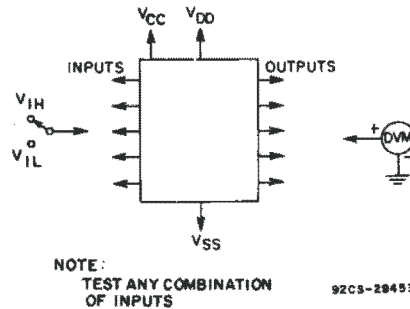

Figure 7. Input Voltage

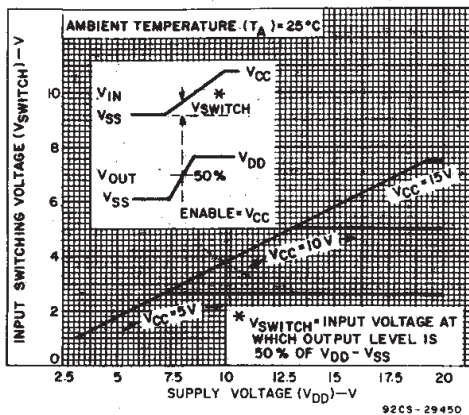

Figure 8. Typical Input Switching as a Function of High-Level Supply Voltage (SELECT at V_{CC} – CMOS Mode)

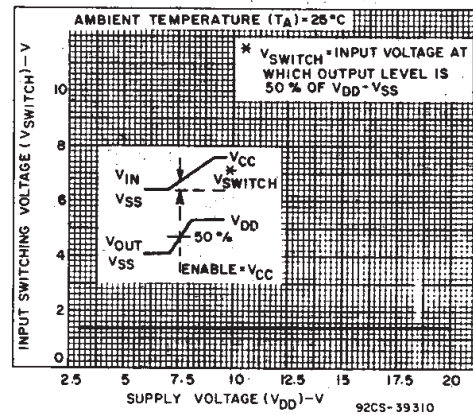

Figure 9. Typical Input Switching as a Function of High-Level Supply Voltage (SELECT at V_{SS} – TTL Mode)

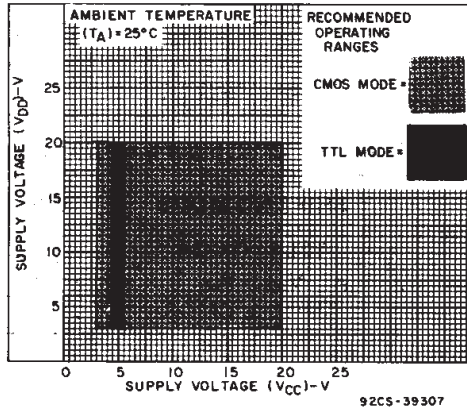
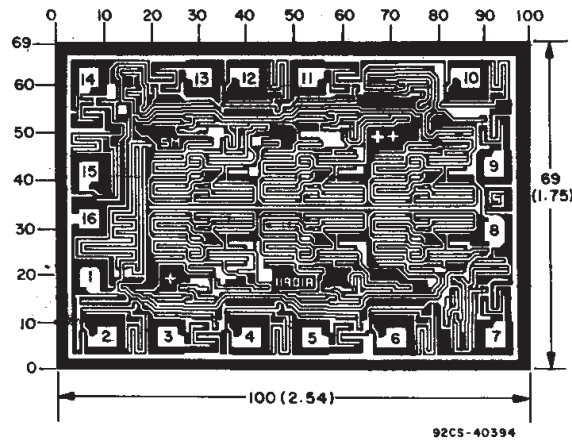

Figure 10. High-Level Supply Voltage vs. Low-Level Supply Voltage



- A. Dimensions in parentheses are in millimeters and are derived from the basic inch dimensions as indicated. Grid graduations are in mils (10^{-3} inch).

Figure 11. Dimensions and Pad Layout

PACKAGING INFORMATION

Orderable Device	Status (1)	Package Type	Package Drawing	Pins	Package Qty	Eco Plan (2)	Lead finish/ Ball material (6)	MSL Peak Temp (3)	Op Temp (°C)	Device Marking (4/5)	Samples
CD4504BMPWREP	ACTIVE	TSSOP	PW	16	2000	RoHS & Green	NIPDAU	Level-1-260C-UNLIM	-55 to 125	4504BEP	Samples
V62/09606-01XE	ACTIVE	TSSOP	PW	16	2000	RoHS & Green	NIPDAU	Level-1-260C-UNLIM	-55 to 125	4504BEP	Samples

(1) The marketing status values are defined as follows:

ACTIVE: Product device recommended for new designs.

LIFEBUY: TI has announced that the device will be discontinued, and a lifetime-buy period is in effect.

NRND: Not recommended for new designs. Device is in production to support existing customers, but TI does not recommend using this part in a new design.

PREVIEW: Device has been announced but is not in production. Samples may or may not be available.

OBsolete: TI has discontinued the production of the device.

(2) **RoHS:** TI defines "RoHS" to mean semiconductor products that are compliant with the current EU RoHS requirements for all 10 RoHS substances, including the requirement that RoHS substance do not exceed 0.1% by weight in homogeneous materials. Where designed to be soldered at high temperatures, "RoHS" products are suitable for use in specified lead-free processes. TI may reference these types of products as "Pb-Free".

RoHS Exempt: TI defines "RoHS Exempt" to mean products that contain lead but are compliant with EU RoHS pursuant to a specific EU RoHS exemption.

Green: TI defines "Green" to mean the content of Chlorine (Cl) and Bromine (Br) based flame retardants meet JS709B low halogen requirements of <=1000ppm threshold. Antimony trioxide based flame retardants must also meet the <=1000ppm threshold requirement.

(3) MSL, Peak Temp. - The Moisture Sensitivity Level rating according to the JEDEC industry standard classifications, and peak solder temperature.

(4) There may be additional marking, which relates to the logo, the lot trace code information, or the environmental category on the device.

(5) Multiple Device Markings will be inside parentheses. Only one Device Marking contained in parentheses and separated by a "-" will appear on a device. If a line is indented then it is a continuation of the previous line and the two combined represent the entire Device Marking for that device.

(6) Lead finish/Ball material - Orderable Devices may have multiple material finish options. Finish options are separated by a vertical ruled line. Lead finish/Ball material values may wrap to two lines if the finish value exceeds the maximum column width.

Important Information and Disclaimer:The information provided on this page represents TI's knowledge and belief as of the date that it is provided. TI bases its knowledge and belief on information provided by third parties, and makes no representation or warranty as to the accuracy of such information. Efforts are underway to better integrate information from third parties. TI has taken and continues to take reasonable steps to provide representative and accurate information but may not have conducted destructive testing or chemical analysis on incoming materials and chemicals. TI and TI suppliers consider certain information to be proprietary, and thus CAS numbers and other limited information may not be available for release.

In no event shall TI's liability arising out of such information exceed the total purchase price of the TI part(s) at issue in this document sold by TI to Customer on an annual basis.

OTHER QUALIFIED VERSIONS OF CD4504B-EP :

- Catalog: [CD4504B](#)
- Military: [CD4504B-MIL](#)

NOTE: Qualified Version Definitions:

- Catalog - TI's standard catalog product
- Military - QML certified for Military and Defense Applications

TAPE AND REEL INFORMATION

QUADRANT ASSIGNMENTS FOR PIN 1 ORIENTATION IN TAPE

*All dimensions are nominal

Device	Package Type	Package Drawing	Pins	SPQ	Reel Diameter (mm)	Reel Width W1 (mm)	A0 (mm)	B0 (mm)	K0 (mm)	P1 (mm)	W (mm)	Pin1 Quadrant
CD4504BMPWREP	TSSOP	PW	16	2000	330.0	12.4	6.9	5.6	1.6	8.0	12.0	Q1

TAPE AND REEL BOX DIMENSIONS

*All dimensions are nominal

Device	Package Type	Package Drawing	Pins	SPQ	Length (mm)	Width (mm)	Height (mm)
CD4504BMPWREP	TSSOP	PW	16	2000	853.0	449.0	35.0



NOTES:

1. All linear dimensions are in millimeters. Any dimensions in parenthesis are for reference only. Dimensioning and tolerancing per ASME Y14.5M.
2. This drawing is subject to change without notice.
3. This dimension does not include mold flash, protrusions, or gate burrs. Mold flash, protrusions, or gate burrs shall not exceed 0.15 mm per side.
4. This dimension does not include interlead flash. Interlead flash shall not exceed 0.25 mm per side.
5. Reference JEDEC registration MO-153.

EXAMPLE BOARD LAYOUT

PW0016A

TSSOP - 1.2 mm max height

SMALL OUTLINE PACKAGE

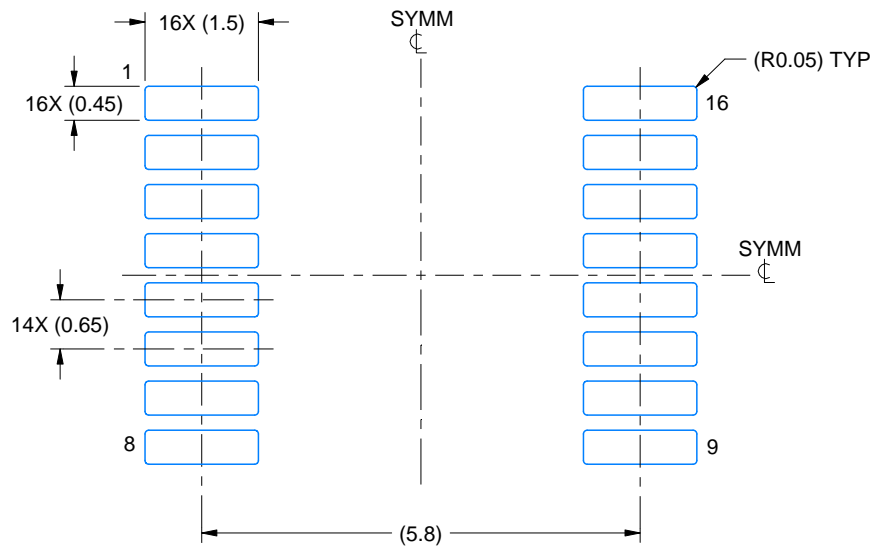

LAND PATTERN EXAMPLE
EXPOSED METAL SHOWN
SCALE: 10X



SOLDER MASK DETAILS

4220204/A 02/2017

NOTES: (continued)

- 6. Publication IPC-7351 may have alternate designs.
- 7. Solder mask tolerances between and around signal pads can vary based on board fabrication site.

EXAMPLE STENCIL DESIGN

PW0016A

TSSOP - 1.2 mm max height

SMALL OUTLINE PACKAGE

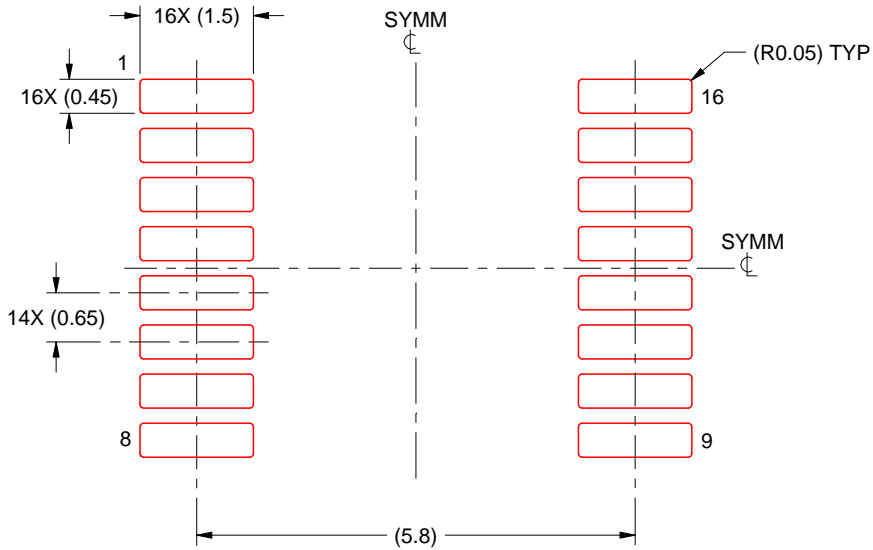

SOLDER PASTE EXAMPLE
BASED ON 0.125 mm THICK STENCIL
SCALE: 10X

4220204/A 02/2017

NOTES: (continued)

8. Laser cutting apertures with trapezoidal walls and rounded corners may offer better paste release. IPC-7525 may have alternate design recommendations.
9. Board assembly site may have different recommendations for stencil design.

IMPORTANT NOTICE AND DISCLAIMER

TI PROVIDES TECHNICAL AND RELIABILITY DATA (INCLUDING DATA SHEETS), DESIGN RESOURCES (INCLUDING REFERENCE DESIGNS), APPLICATION OR OTHER DESIGN ADVICE, WEB TOOLS, SAFETY INFORMATION, AND OTHER RESOURCES "AS IS" AND WITH ALL FAULTS, AND DISCLAIMS ALL WARRANTIES, EXPRESS AND IMPLIED, INCLUDING WITHOUT LIMITATION ANY IMPLIED WARRANTIES OF MERCHANTABILITY, FITNESS FOR A PARTICULAR PURPOSE OR NON-INFRINGEMENT OF THIRD PARTY INTELLECTUAL PROPERTY RIGHTS.

These resources are intended for skilled developers designing with TI products. You are solely responsible for (1) selecting the appropriate TI products for your application, (2) designing, validating and testing your application, and (3) ensuring your application meets applicable standards, and any other safety, security, regulatory or other requirements.

These resources are subject to change without notice. TI grants you permission to use these resources only for development of an application that uses the TI products described in the resource. Other reproduction and display of these resources is prohibited. No license is granted to any other TI intellectual property right or to any third party intellectual property right. TI disclaims responsibility for, and you will fully indemnify TI and its representatives against, any claims, damages, costs, losses, and liabilities arising out of your use of these resources.

TI's products are provided subject to [TI's Terms of Sale](#) or other applicable terms available either on [ti.com](#) or provided in conjunction with such TI products. TI's provision of these resources does not expand or otherwise alter TI's applicable warranties or warranty disclaimers for TI products.

TI objects to and rejects any additional or different terms you may have proposed.

Mailing Address: Texas Instruments, Post Office Box 655303, Dallas, Texas 75265
Copyright © 2022, Texas Instruments Incorporated