

RDED72J473K3M1H03A



Applications

Unsuitable Applications	Please be sure to read and comply with these "Precautions for use."
Specific Applications	Consumer equipment, Industrial Equipment, Mobile Electronics, Medical equipment [GHF A/B/C] except for implant equipment, Automotive infotainment/comfort equipment Please refer to Our Website and specifications, etc. for information about the performance, functions, quality, management, and safety required for the above applications, and use Products after confirming the performance and reliability of the actual Product.

Notices

HF(Halogen Free)

Appearance & Shape

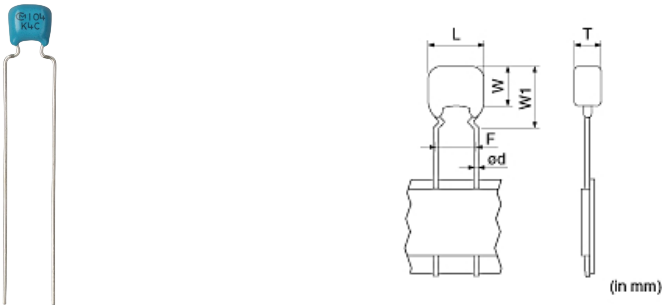

References

Packaging	Specifications	Standard Packing Quantity
A	Ammo Pack	2000

Mass (typ.)	
1 piece	0.22g

Attention
 1.This datasheet is downloaded from the website of Murata Manufacturing Co., Ltd. Therefore, it's specifications are subject to change or our products in it may be discontinued without advance notice. Please check with our sales representatives or product engineers before ordering.
 2.This datasheet has only typical specifications because there is no space for detailed specifications.
 Therefore, please review our product specifications or consult the approval sheet for product specifications before ordering.

RDED72J473K3M1H03A



Specifications

L size or Outer diameter D	5.5mm max.
Width	5.0mm max.
T size	4.0mm max.
Lead spacing F	5.0+0.6/-0.2mm
Lead diameter d	0.5±0.05mm
Capacitance	47000pF ±10%
Rated voltage	630Vdc
Temperature characteristics	X7T(EIA)
Capacitance change rate	+22/-33%
Temperature range of temperature characteristics	-55°C to 125°C
Operating Temperature Range	-55°C to 125°C
W1 size	7.5mm max.

Attention

1.This datasheet is downloaded from the website of Murata Manufacturing Co., Ltd. Therefore, it's specifications are subject to change or our products in it may be discontinued without advance notice. Please check with our sales representatives or product engineers before ordering.

2.This datasheet has only typical specifications because there is no space for detailed specifications.

Therefore, please review our product specifications or consult the approval sheet for product specifications before ordering.

RDED72J473K3M1H03A



Characteristic Data

The charts below may show another part number which shares its characteristics.

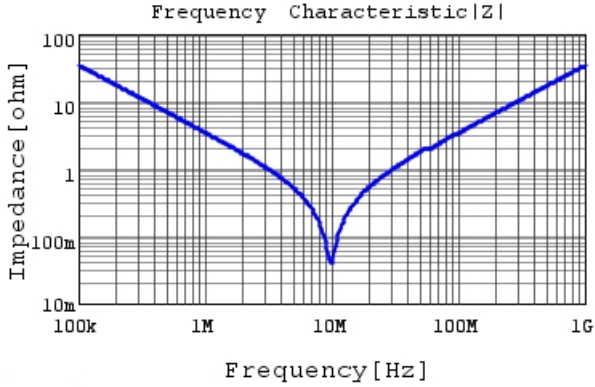

RDED72J473K3M1H03A |Z| DC0V,25degC

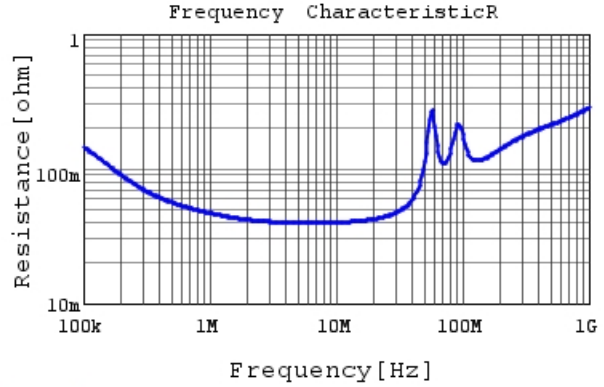

RDED72J473K3M1H03A R DC0V,25degC

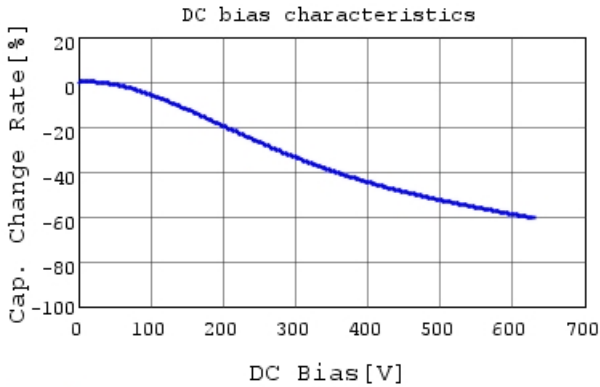

RDED72J473K3M1H03A C-DC bias capchange, 25.0

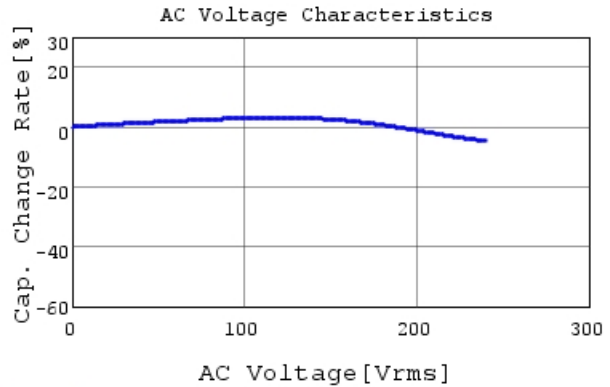

RDED72J473K3M1H03A C-AC Voltage capchange, I

Attention

- 1.This datasheet is downloaded from the website of Murata Manufacturing Co., Ltd. Therefore, it's specifications are subject to change or our products in it may be discontinued without advance notice. Please check with our sales representatives or product engineers before ordering.
- 2.This datasheet has only typical specifications because there is no space for detailed specifications. Therefore, please review our product specifications or consult the approval sheet for product specifications before ordering.

RDED72J473K3M1H03A

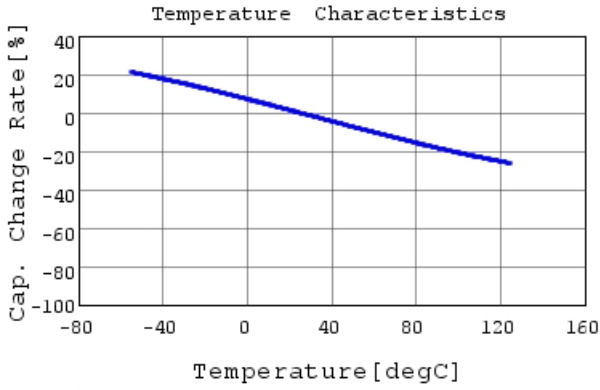

RDED72J473K3M1H03A C-Temp. capchange, DCOV,

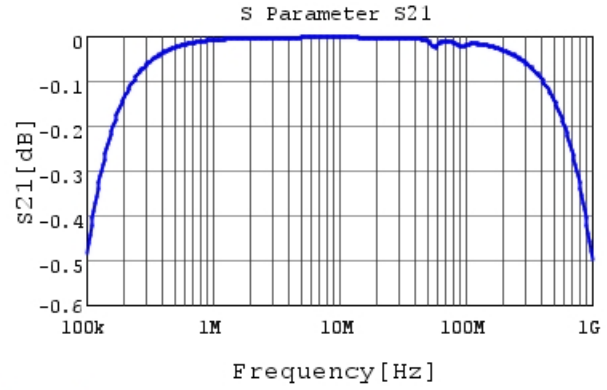

RDED72J473K3M1H03A S21 DCOV, 25degC

Attention

- 1.This datasheet is downloaded from the website of Murata Manufacturing Co., Ltd. Therefore, it's specifications are subject to change or our products in it may be discontinued without advance notice. Please check with our sales representatives or product engineers before ordering.
- 2.This datasheet has only typical specifications because there is no space for detailed specifications. Therefore, please review our product specifications or consult the approval sheet for product specifications before ordering.