

DELIVERY SPECIFICATION

SPEC. No. C-ULI-c

D A T E : Oct., 2021

To

Non-Controlled Copy

CUSTOMER'S PRODUCT NAME

TDK PRODUCT NAME

Multilayer Ceramic Chip Capacitors
 Ultra Low Inductance
 Bulk and Tape packaging 【RoHS compliant】
 CLLC1A Type
 X6S,X7R,X7S Characteristics

Please return this specification to TDK representatives with your signature.
 If orders are placed without returned specification, please allow us to judge that specification is accepted by your side.

RECEIPT CONFIRMATION

DATE: _____ YEAR _____ MONTH _____ DAY _____

TDK Corporation
 Sales
 Electronic Components
 Sales & Marketing Group

Engineering
 Electronic Components Business Company
 Ceramic Capacitors Business Group

APPROVED	Person in charge

APPROVED	CHECKED	Person in charge

SCOPE

This delivery specification shall be applied to Multilayer ceramic chip capacitors to be delivered to _____.

PRODUCTION PLACES

Production places defined in this specification shall be TDK Corporation, TDK(Suzhou)Co.,Ltd and TDK Components U.S.A.,Inc.

PRODUCT NAME

The name of the product to be defined in this specifications shall be CLLC1A○○○△△□□□×.

REFERENCE STANDARD

- JIS C 5101-1 : 2010 Fixed capacitors for use in electronic equipment-Part 1: Generic specification
 C 5101-22 : 2014 Fixed capacitors for use in electronic equipment-Part 22 : Sectional specification : Fixed surface mount multilayer capacitors of ceramic dielectric,Class2
 C 0806-3 : 2014 Packaging of components for automatic handling - Part 3: Packaging of surface mount components on continuous tapes
 JEITA RCR-2335 C 2014 Safety application guide for fixed ceramic capacitors for use in electronic equipment

CONTENTS

1. CODE CONSTRUCTION
2. COMBINATION OF RATED CAPACITANCE AND TOLERANCE
3. OPERATING TEMPERATURE RANGE
4. STORING CONDITION AND TERM
5. INDUSTRIAL WASTE DISPOSAL
6. PERFORMANCE
7. INSIDE STRUCTURE AND MATERIAL
8. PACKAGING
9. EQUIVALENT CIRCUIT
10. SOLDERING CONDITION
11. CAUTION
12. TAPE PACKAGING SPECIFICATION

<EXPLANATORY NOTE>

When the mistrust in the spec arises, this specification is given priority. And it will be confirmed by written spec change after conference of both posts involved.

This specification warrants the quality of the ceramic chip capacitor. Capacitors should be evaluated or confirmed a state of mounted on your product.

If the use of the capacitors goes beyond the bounds of this specification, we can not afford to guarantee.

Division	Date	SPEC. No.
Ceramic Capacitors Business Group	October, 2021	C-ULI-c

1. CODE CONSTRUCTION

(Example) CLLC1A X7S 0G 105 M T 0000
 (1) (2) (3) (4) (5) (6) (7)

(1) Type

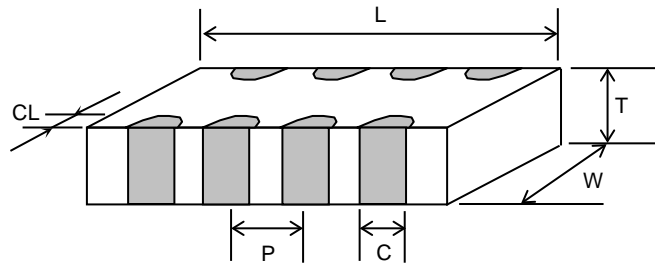

Case size [EIA style]	Dimensions (Unit : mm)					
	L	W	T	P	C	CL
CLLC1A [CC0603]	1.60 ± 0.10	0.80 ± 0.10	0.50 ^{+0.05} _{-0.10}	0.40 ± 0.10	0.25 ± 0.10	0.15 ± 0.10

* As for each item, please refer to detail page on TDK web.

(2) Temperature Characteristics

* Details are shown in table 1 No.6 at 6.PERFORMANCE

(3) Rated Voltage

Symbol	Rated Voltage
0G	DC 4 V

(4) Rated Capacitance

Stated in three digits and in units of pico farads (pF).
 The first and Second digits identify the first and second significant figures of the capacitance, the third digit identifies the multiplier.

(Example)

Symbol	Rated Capacitance
105	1,000,000 pF

(5) Capacitance tolerance

Symbol	Tolerance
M	± 20 %

(6) Packaging

Symbol	Packaging
B	Bulk
T	Taping

(7) TDK internal code

2. COMBINATION OF RATED CAPACITANCE AND TOLERANCE

Temperature Characteristics	Capacitance tolerance	Rated capacitance
X6S X7R X7S	M ($\pm 20\%$)	E – 6 series

Capacitance Step in E series

E series	Capacitance Step					
E- 6	1.0	1.5	2.2	3.3	4.7	6.8

3. OPERATING TEMPERATURE RANGE

T.C.	Min. operating Temperature	Max. operating Temperature	Reference Temperature
X6S	-55°C	105°C	25°C
X7R X7S	-55°C	125°C	25°C

4. STORING CONDITION AND TERM

Storing temperature	Storing humidity	Storing term
5~40°C	20~70%RH	Within 6 months upon receipt.

5. INDUSTRIAL WASTE DISPOSAL

Dispose this product as industrial waste in accordance with the Industrial Waste Law.

6. PERFORMANCE

table 1

No.	Item	Performance	Test or inspection method														
1	External Appearance	No defects which may affect performance.	Inspect with magnifying glass(3×)														
2	Insulation Resistance	100MΩ·μF min.	Measuring voltage : Rated voltage Voltage application time : 60s. Measure 8 terminal electrodes at the same time.														
3	Voltage Proof	Withstand test voltage without insulation breakdown or other damage.	Applied voltage : 2.5 times of rated voltage Above DC voltage shall be applied between each terminal in equivalent circuit for 1s. Charge / discharge current : 50mA or lower														
4	Capacitance	Within the specified tolerance.	<table border="1"> <thead> <tr> <th>Measuring frequency</th> <th>Measuring voltage</th> </tr> </thead> <tbody> <tr> <td>1kHz±10%</td> <td>0.5±0.2Vrms.</td> </tr> </tbody> </table> <p>Measure 8 terminal electrodes at the same time.</p>	Measuring frequency	Measuring voltage	1kHz±10%	0.5±0.2Vrms.										
Measuring frequency	Measuring voltage																
1kHz±10%	0.5±0.2Vrms.																
5	Dissipation Factor	Please refer to detail page on TDK web.	See No.4 in this table for measuring condition.														
6	Temperature Characteristics of Capacitance	<p>Capacitance Change (%)</p> <table border="1"> <thead> <tr> <th>No voltage applied</th> </tr> </thead> <tbody> <tr> <td>X6S : ±22</td> </tr> <tr> <td>X7R : ±15</td> </tr> <tr> <td>X7S : ±22</td> </tr> </tbody> </table>	No voltage applied	X6S : ±22	X7R : ±15	X7S : ±22	<p>Capacitance shall be measured by the steps shown in the following table after thermal equilibrium is obtained for each step. Capacitance change shall be calculated by the value of the reference temperature in Step 3.</p> <table border="1"> <thead> <tr> <th>Step</th> <th>Temperature(°C)</th> </tr> </thead> <tbody> <tr> <td>1</td> <td>Reference temp. ± 2</td> </tr> <tr> <td>2</td> <td>Min. operating temp. ± 2</td> </tr> <tr> <td>3</td> <td>Reference temp. ± 2</td> </tr> <tr> <td>4</td> <td>Max. operating temp. ± 2</td> </tr> </tbody> </table> <p>As for Min./Max. operating temp and Reference temp., please refer to “3.OPERATING TEMPERATURE RANGE” As for measuring voltage, please contact with our sales representative.</p>	Step	Temperature(°C)	1	Reference temp. ± 2	2	Min. operating temp. ± 2	3	Reference temp. ± 2	4	Max. operating temp. ± 2
No voltage applied																	
X6S : ±22																	
X7R : ±15																	
X7S : ±22																	
Step	Temperature(°C)																
1	Reference temp. ± 2																
2	Min. operating temp. ± 2																
3	Reference temp. ± 2																
4	Max. operating temp. ± 2																

(continued)

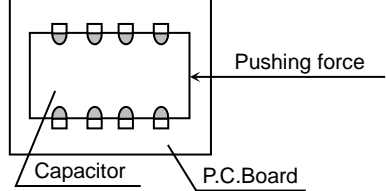
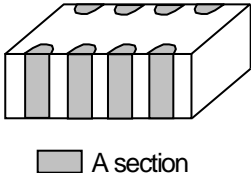
No.	Item	Performance	Test or inspection method				
7	Robustness of Terminations	No sign of termination coming off, breakage of ceramic, or other abnormal signs.	<p>Reflow solder the capacitors on a P.C.Board shown in Appendix1.</p> <p>Apply a pushing force gradually at the center of a specimen in a horizontal direction of P.C.Board.</p> <p>Pushing force : 5N Holding time : 10±1s</p> 				
8	Solderability	<p>All terminations shall exhibit a continuous solder coating free from defects for a minimum of 75% of the surface area of any individual termination. Anomalies other than dewetting, non-wetting, and pin holes are not cause for rejection.</p> 	<p>Solder : Sn-3.0Ag-0.5Cu</p> <p>Flux : Isopropyl alcohol (JIS K 8839) Rosin (JIS K 5902) 25% solid solution.</p> <p>Solder temp. : 245±5°C</p> <p>Dwell time : 3±0.3s.</p> <p>Solder position : Until both terminations are completely soaked.</p>				
9	Resistance to solder heat	External appearance	No cracks are allowed and terminations shall be covered at least 60% with new solder.				
		Capacitance	<table border="1"> <thead> <tr> <th>Characteristics</th> <th>Change from the value before test</th> </tr> </thead> <tbody> <tr> <td>X6S X7R X7S</td> <td>± 7.5 %</td> </tr> </tbody> </table>	Characteristics	Change from the value before test	X6S X7R X7S	± 7.5 %
		Characteristics	Change from the value before test				
		X6S X7R X7S	± 7.5 %				
D.F.	Meet the initial spec.						
Insulation Resistance	Meet the initial spec.						
			<p>Solder : Sn-3.0Ag-0.5Cu</p> <p>Flux : Isopropyl alcohol (JIS K 8839) Rosin (JIS K 5902) 25% solid solution.</p> <p>Solder temp. : 260±5°C</p> <p>Dwell time : 10±1s.</p> <p>Solder position : Until both terminations are completely soaked.</p> <p>Pre-heating : Temp. — 110~140°C Time — 30~60s.</p> <p>Leave the capacitors in ambient condition for 24±2h before measurement.</p>				

(continued)

No.	Item	Performance	Test or inspection method															
10	Vibration	External appearance	Frequency : 10~55~10Hz Reciprocating sweep time : 1 min. Amplitude : 1.5mm Repeat this for 2h each in 3 perpendicular directions(Total 6h). Reflow solder the capacitors on a P.C.Board shown in Appendix1 before testing.															
		Capacitance		Characteristics	Change from the value before test													
				X6S X7R X7S	± 7.5 %													
		D.F.		Meet the initial spec.														
11	Temperature cycle	External appearance	Expose the capacitors in the condition step1 through step 4 listed in the following table. Temp. cycle : 5 cycles <table border="1" data-bbox="991 790 1457 1126"> <thead> <tr> <th>Step</th> <th>Temperature(°C)</th> <th>Time (min.)</th> </tr> </thead> <tbody> <tr> <td>1</td> <td>Min. operating temp.±3</td> <td>30 ± 3</td> </tr> <tr> <td>2</td> <td>Ambient Temp.</td> <td>2 ~ 5</td> </tr> <tr> <td>3</td> <td>Max. operating temp.±2</td> <td>30 ± 2</td> </tr> <tr> <td>4</td> <td>Ambient Temp.</td> <td>2 ~ 5</td> </tr> </tbody> </table> As for Min./Max. operating temp., please refer to "3. OPERATING TEMPERATURE RANGE" Leave the capacitors in ambient condition for 24±2h before measurement. Reflow solder the capacitors on a P.C.Board shown in Appendix1 before testing.	Step	Temperature(°C)	Time (min.)	1	Min. operating temp.±3	30 ± 3	2	Ambient Temp.	2 ~ 5	3	Max. operating temp.±2	30 ± 2	4	Ambient Temp.	2 ~ 5
		Step		Temperature(°C)	Time (min.)													
		1		Min. operating temp.±3	30 ± 3													
		2		Ambient Temp.	2 ~ 5													
		3		Max. operating temp.±2	30 ± 2													
		4		Ambient Temp.	2 ~ 5													
Capacitance	Characteristics	Change from the value before test																
	X6S X7R X7S	Please contact with our sales representative.																
D.F.	Meet the initial spec.																	
Insulation Resistance	Meet the initial spec.																	
Voltage proof	No insulation breakdown or other damage.																	
12	Moisture Resistance (Steady State)	External appearance	Test temp. : 40±2°C Test humidity : 90~95%RH Test time : 500 +24,0h Leave the capacitors in ambient condition for 24±2h before measurement. Reflow solder the capacitors on a P.C.Board shown in Appendix1 before testing.															
		Capacitance		Characteristics	Change from the value before test													
				X6S X7R X7S	Please contact with our sales representative.													
		D.F.		200% of initial spec. max.														
Insulation Resistance	10MΩ·μF min.																	

(continued)

No.	Item		Performance	Test or inspection method	
13	Moisture Resistance	External appearance	No mechanical damage.	Test temp. : 40±2°C Test humidity : 90~95%RH Applied voltage : Rated voltage Test time : 500 +24,0h Charge/discharge current : 50mA or lower Leave the capacitors in ambient condition for 24±2h before measurement. Reflow solder the capacitors on a P.C.Board shown in Appendix1 before testing. Initial value setting Voltage conditioning 《After voltage treat the capacitors under testing temperature and voltage for 1 hour,》 leave the capacitors in ambient condition for 24±2h before measurement. Use this measurement for initial value.	
		Capacitance	Characteristics		Change from the value before test
			X6S X7R X7S		Please contact with our sales representative.
		D.F.	200% of initial spec. max.		
14	Life	External appearance	No mechanical damage.	Test temp. : Maximum operating temperature±2°C Applied voltage : Please contact with our sales representative. Test time : 1,000 +48,0h Charge/discharge current : 50mA or lower Leave the capacitors in ambient condition for 24±2h before measurement. Reflow solder the capacitors on a P.C.Board shown in Appendix1 before testing. Initial value setting Voltage conditioning 《After voltage treat the capacitors under testing temperature and voltage for 1 hour,》 leave the capacitors in ambient condition for 24±2h before measurement. Use this measurement for initial value.	
		Capacitance	Characteristics		Change from the value before test
			X6S X7R X7S		Please contact with our sales representative.
		D.F.	200% of initial spec. max.		
Insulation Resistance	10MΩ·μF min.				

*As for the initial measurement of capacitors on number 6,9,10,11 and 12, leave capacitors at 150 0,-10°C for 1h and measure the value after leaving capacitors for 24±2h in ambient condition.

Appendix 1 CLLC1A

P.C. Board for reliability test

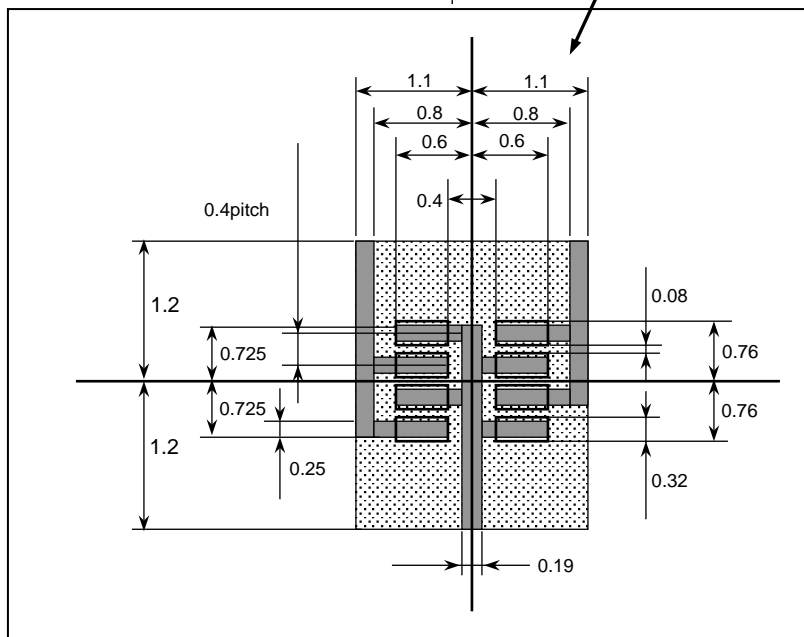
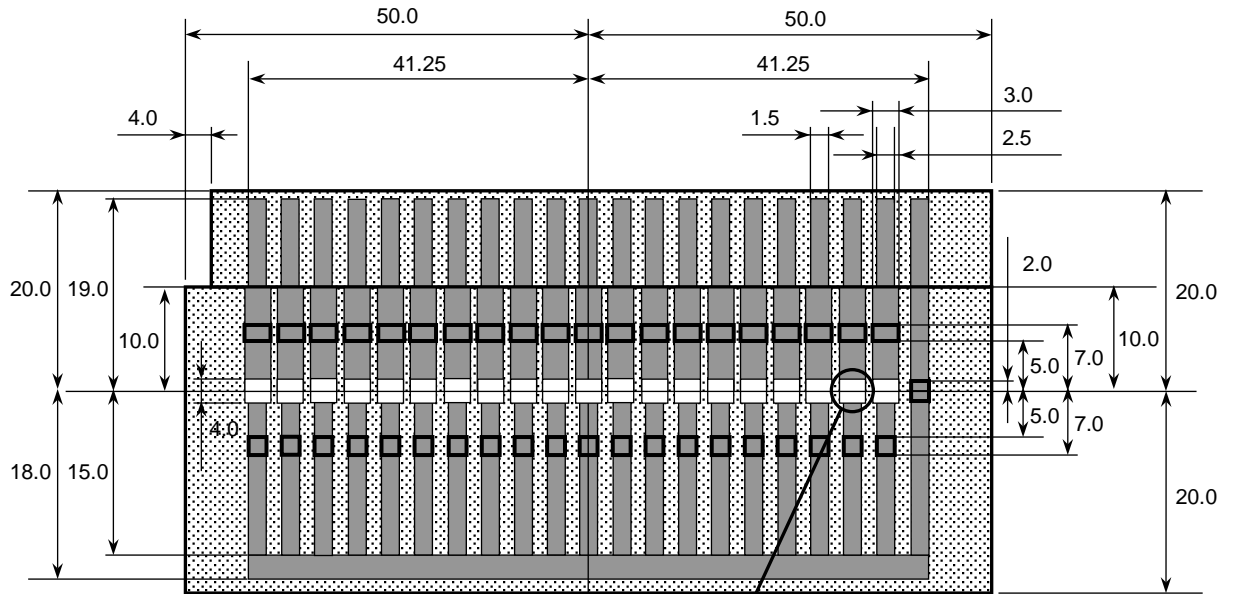

(Unit: mm)

1. Material : Glass Epoxy (As per JIS C6484 GE4)

2. Thickness : 0.8mm

- Copper (Thickness: 0.035mm)
- Solder resist

7. INSIDE STRUCTURE AND MATERIAL

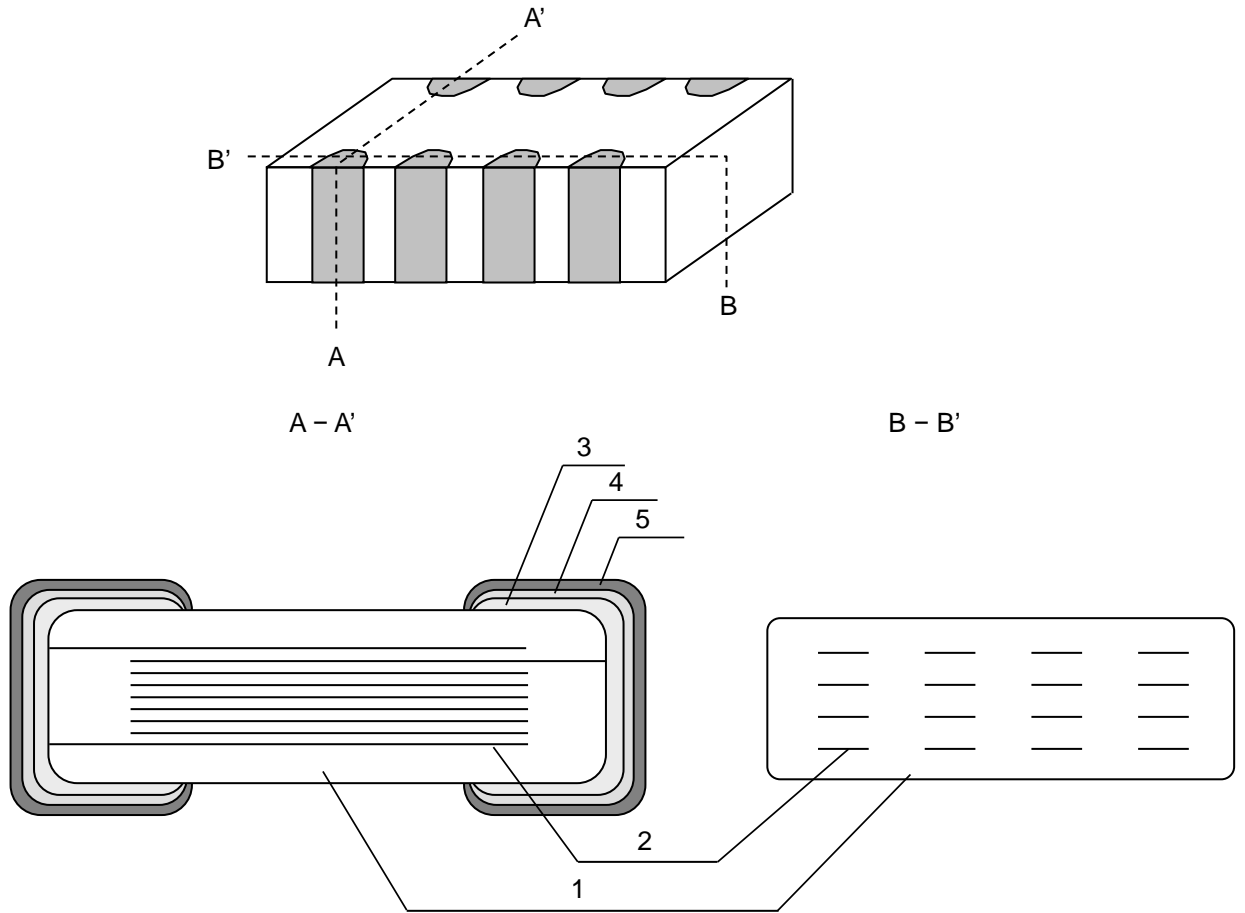

No.	NAME	MATERIAL
1	Dielectric	BaTiO ₃
2	Electrode	Nickel (Ni)
3	Termination	Copper (Cu)
4		Nickel (Ni)
5		Tin (Sn)

8. EQUIVALENT CIRCUIT

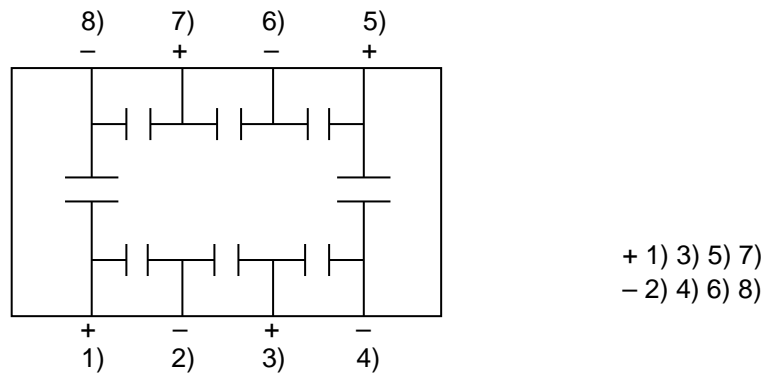

8 terminals are connected and measured at the same time.

9. PACKAGING

Packaging shall be done to protect the components from the damage during transportation and storing, and a label which has the following information shall be attached.

9.1 Each plastic bag for bulk packaging contains 1000pcs. And the minimum quantity for Bulk packaging is 1000pcs.

9.2 Tape packaging is as per 12. TAPE PACKAGING SPECIFICATION.

- 1) Inspection No.*
- 2) TDK P/N
- 3) Customer's P/N
- 4) Quantity

*Composition of Inspection No.

Example E 1 A - 23 - 001
 (a) (b) (c) (d) (e)

- (a) Line code
- (b) Last digit of the year
- (c) Month and A for January and B for February and so on. (Skip I)
- (d) Inspection Date of the month.
- (e) Serial No. of the day

*Composition of new Inspection No.

(Implemented on and after May 1, 2019 in sequence)

Example

I	F	1	E	2	3	A	0	0	1
---	---	---	---	---	---	---	---	---	---

 (a) (b) (c) (d) (e) (f) (g)

- (a) Prefix
- (b) Line code
- (c) Last digit of the year
- (d) Month and A for January and B for February and so on. (Skip I)
- (e) Inspection Date of the month.
- (f) Serial No. of the day(00 ~ ZZ)
- (g) Suffix(00 ~ ZZ)

* It was shifted to the new inspection No. on and after May 2019, but the implementation timing may be different depending on shipment bases. Until the shift is completed, either current or new composition of inspection No. will be applied.

10. SOLDERING CONDITION

Reflow soldering only.

11. CAUTION

No.	Process	Condition
1	Operating Condition (Storage, Use, Transportation)	<p>1-1. Storage, Use The capacitors must be stored in an ambient temperature of 5 to 40°C with a relative humidity of 20 to 70%RH. JIS C 60721-3-1 Class 1K2 should be followed for the other climatic conditions.</p> <ol style="list-style-type: none"> 1) High temperature and humidity environment may affect a capacitor's solder ability because it accelerates terminal oxidization. They also deteriorate performance of taping and packaging. Therefore, SMD capacitors shall be used within 6 months. For capacitors with terminal electrodes consisting of silver or silver-palladium which tend to become oxidized or sulfurized, use as soon as possible, such as within one month after opening the bag. 2) When capacitors are stored for a longer time period than 6 months, confirm the solderability of the capacitors prior to use. During storage, keep the minimum packaging unit in its original packaging without opening it. Do not deviate from the above temperature and humidity conditions even for a short term. 3) Corrosive gasses in the air or atmosphere may result in deterioration of the reliability, such as poor solderability of the terminal electrodes. Do not store capacitors where they will be exposed to corrosive gas (e.g., hydrogen sulfide, sulfur dioxide, chlorine ammonia etc.) 4) Solderability and electrical performance may deteriorate due to photochemical change in the terminal electrode if stored in direct sunlight, or due to condensation from rapid changes in humidity. The capacitors especially which use resin material must be operated and stored in an environment free of dew condensation, as moisture absorption due to condensation may affect the performance. 5) Refer to JIS C 60721-3-1, class 1K2 for other climate conditions. <p>1-2. Handling in transportation In case of the transportation of the capacitors, the performance of the capacitors may be deteriorated depending on the transportation condition. (Refer to JEITA RCR-2335C 9.2 Handling in transportation)</p>
2	Circuit design  Caution	<p>2-1. Operating temperature</p> <ol style="list-style-type: none"> 1) Upper category temperature (maximum operating temperature) is specified. It is necessary to select a capacitor whose rated temperature is higher than the operating temperature. Also, it is necessary to consider the temperature distribution in the equipment and seasonal temperature variation. 2) Do not use capacitors above the maximum allowable operating temperature. Surface temperature including self heating should be below maximum operating temperature. (Due to dielectric loss, capacitors will heat itself when AC is applied. Especially for high frequency circuit, the heat might be so extreme that it may damage itself or the product mounted on. Please design the circuit so that the maximum temperature of the capacitors including the self heating to be below the maximum allowable operating temperature. Temperature rise at capacitor surface shall be below 20°C) 3) The electrical characteristics of the capacitors will vary depending on the temperature. The capacitors should be selected and designed in taking the temperature into consideration. <p>2-2. When overvoltage is applied Applying overvoltage to a capacitor may cause dielectric breakdown and result in a short circuit. The duration until dielectric breakdown depends on the applied voltage and the ambient temperature.</p>

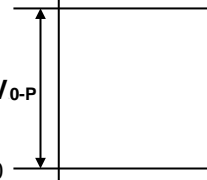
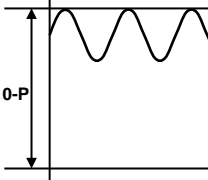
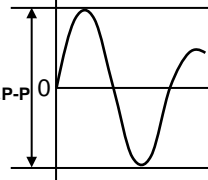
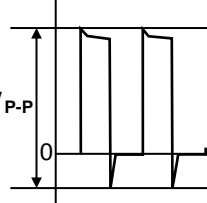
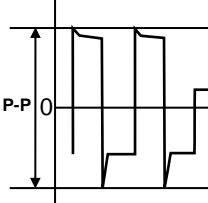
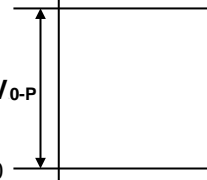
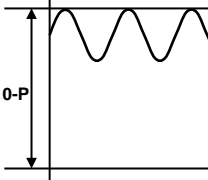
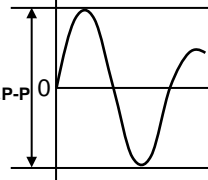
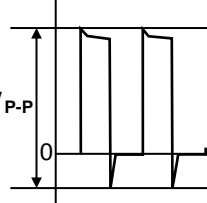
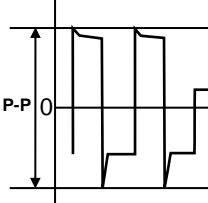
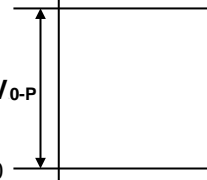
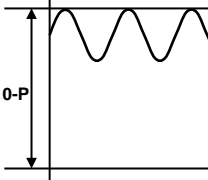
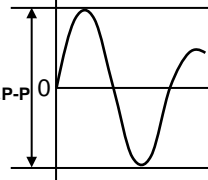
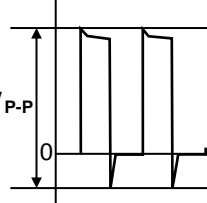
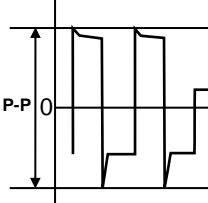
No.	Process	Condition														
2	Circuit design  Caution	<p>2-3. Operating voltage</p> <p>1) Operating voltage across the terminals should be below the rated voltage. When AC and DC are super imposed, V_{0-P} must be below the rated voltage. — (1) and (2) AC or pulse with overshooting, V_{P-P} must be below the rated voltage. — (3), (4) and (5) When the voltage is started to apply to the circuit or it is stopped applying, the irregular voltage may be generated for a transit period because of resonance or switching. Be sure to use the capacitors within rated voltage containing these Irregular voltage.</p> <table border="1" data-bbox="486 526 1476 795"> <thead> <tr> <th data-bbox="486 526 678 571">Voltage</th> <th data-bbox="678 526 941 571">(1) DC voltage</th> <th data-bbox="941 526 1204 571">(2) DC+AC voltage</th> <th data-bbox="1204 526 1476 571">(3) AC voltage</th> </tr> </thead> <tbody> <tr> <td data-bbox="486 571 678 795">Positional Measurement (Rated voltage)</td> <td data-bbox="678 571 941 795">  </td> <td data-bbox="941 571 1204 795">  </td> <td data-bbox="1204 571 1476 795">  </td> </tr> </tbody> </table> <table border="1" data-bbox="486 817 1204 1108"> <thead> <tr> <th data-bbox="486 817 678 862">Voltage</th> <th data-bbox="678 817 941 862">(4) Pulse voltage (A)</th> <th data-bbox="941 817 1204 862">(5) Pulse voltage (B)</th> </tr> </thead> <tbody> <tr> <td data-bbox="486 862 678 1108">Positional Measurement (Rated voltage)</td> <td data-bbox="678 862 941 1108">  </td> <td data-bbox="941 862 1204 1108">  </td> </tr> </tbody> </table> <p>2) Even below the rated voltage, if repetitive high frequency AC or pulse is applied, the reliability of the capacitors may be reduced.</p> <p>3) The effective capacitance will vary depending on applied DC and AC voltages. The capacitors should be selected and designed in taking the voltages into consideration.</p> <p>4) Abnormal voltage (surge voltage, static electricity, pulse voltage, etc.) shall not exceed the rated voltage.</p> <p>5) When capacitors are used in a series connection, it is necessary to add a balancing circuit such as voltage dividing resistors in order to avoid an imbalance in the voltage applied to each capacitor.</p> <p>2-4. Frequency</p> <p>When the capacitors are used in AC and/or pulse voltages, the capacitors may vibrate themselves and generate audible sound.</p>	Voltage	(1) DC voltage	(2) DC+AC voltage	(3) AC voltage	Positional Measurement (Rated voltage)				Voltage	(4) Pulse voltage (A)	(5) Pulse voltage (B)	Positional Measurement (Rated voltage)		
Voltage	(1) DC voltage	(2) DC+AC voltage	(3) AC voltage													
Positional Measurement (Rated voltage)																
Voltage	(4) Pulse voltage (A)	(5) Pulse voltage (B)														
Positional Measurement (Rated voltage)																

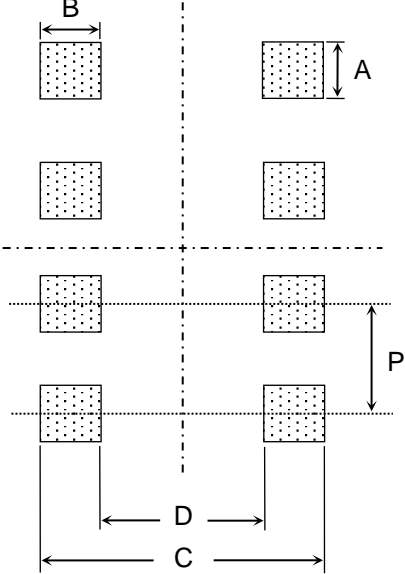
No.	Process	Condition												
3	Designing P.C. board	<p>The amount of solder at the terminations has a direct effect on the reliability of the capacitors.</p> <ol style="list-style-type: none"> 1) The greater the amount of solder, the higher the stress on the chip capacitor, and the more likely that it will break. When designing a P.C. board, determine the shape and size of the solder lands to have proper amount of solder on the terminations. 2) Avoid using common solder land for multiple terminations and provide individual solder land for each terminations. 3) Size and recommended land dimensions. <div style="text-align: center;">  </div> <p style="text-align: center;">Recommended Land Dimensions (Unit : mm)</p> <table border="1" style="margin-left: auto; margin-right: auto;"> <thead> <tr> <th style="text-align: center;">Case size Symbol</th> <th style="text-align: center;">CLLC1A [CC0603]</th> </tr> </thead> <tbody> <tr> <td style="text-align: center;">A</td> <td style="text-align: center;">0.25</td> </tr> <tr> <td style="text-align: center;">B</td> <td style="text-align: center;">0.40</td> </tr> <tr> <td style="text-align: center;">C</td> <td style="text-align: center;">1.20</td> </tr> <tr> <td style="text-align: center;">D</td> <td style="text-align: center;">0.40</td> </tr> <tr> <td style="text-align: center;">P</td> <td style="text-align: center;">0.40</td> </tr> </tbody> </table>	Case size Symbol	CLLC1A [CC0603]	A	0.25	B	0.40	C	1.20	D	0.40	P	0.40
Case size Symbol	CLLC1A [CC0603]													
A	0.25													
B	0.40													
C	1.20													
D	0.40													
P	0.40													

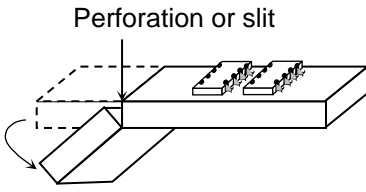
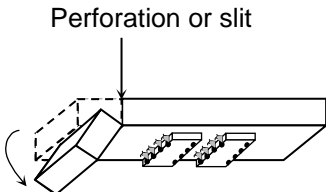
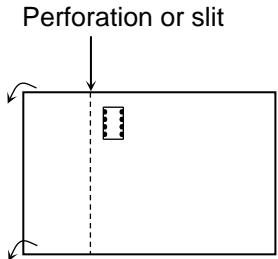
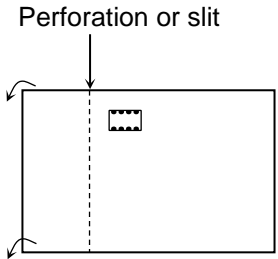
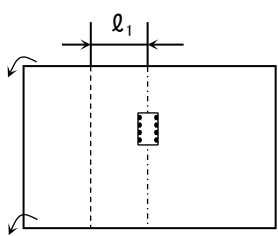
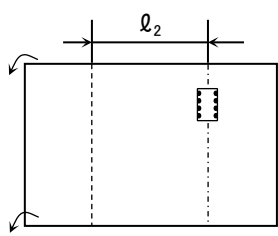
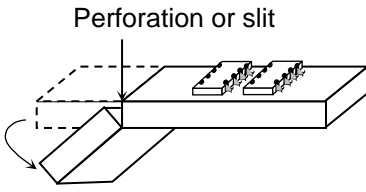
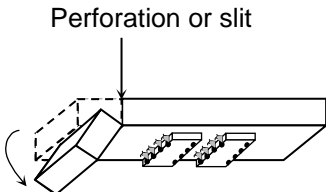
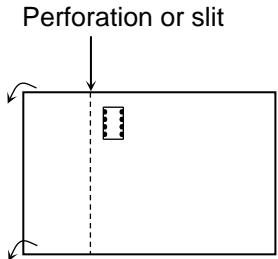
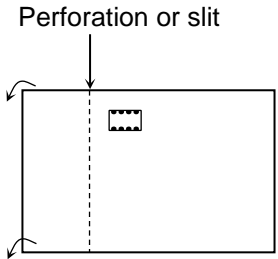
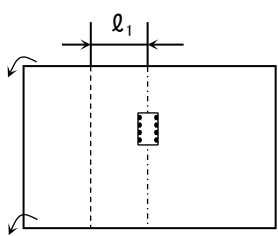
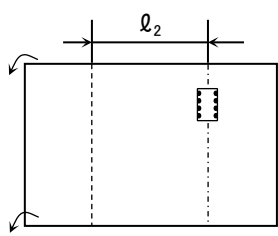
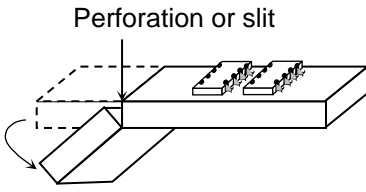
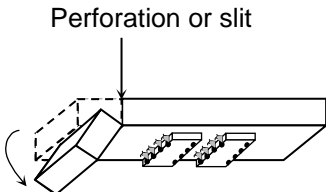
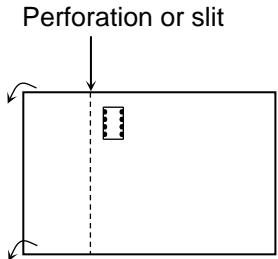
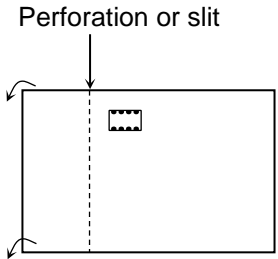
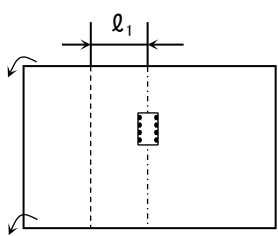
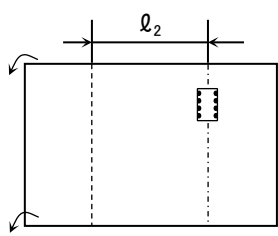
No.	Process	Condition												
3	Designing P.C.board	<p>4) Recommended chip capacitor layout is as following.</p> <table border="1" style="width: 100%; border-collapse: collapse;"> <thead> <tr> <th style="width: 20%;"></th> <th style="width: 40%;">Disadvantage against bending stress</th> <th style="width: 40%;">Advantage against bending stress</th> </tr> </thead> <tbody> <tr> <td style="text-align: center; vertical-align: middle;">Mounting face</td> <td style="text-align: center;"> <p>Perforation or slit</p>  <p>Break P.C.board with mounted side up.</p> </td> <td style="text-align: center;"> <p>Perforation or slit</p>  <p>Break P.C.board with mounted side down.</p> </td> </tr> <tr> <td style="text-align: center; vertical-align: middle;">Chip arrangement (Direction)</td> <td style="text-align: center;"> <p>Perforation or slit</p>  <p>Mount perpendicularly to perforation or slit</p> </td> <td style="text-align: center;"> <p>Perforation or slit</p>  <p>Mount in parallel with perforation or slit</p> </td> </tr> <tr> <td style="text-align: center; vertical-align: middle;">Distance from slit</td> <td style="text-align: center;"> <p>Closer to slit is higher stress</p>  <p>($l_1 < l_2$)</p> </td> <td style="text-align: center;"> <p>Away from slit is less stress</p>  <p>($l_1 < l_2$)</p> </td> </tr> </tbody> </table>		Disadvantage against bending stress	Advantage against bending stress	Mounting face	<p>Perforation or slit</p>  <p>Break P.C.board with mounted side up.</p>	<p>Perforation or slit</p>  <p>Break P.C.board with mounted side down.</p>	Chip arrangement (Direction)	<p>Perforation or slit</p>  <p>Mount perpendicularly to perforation or slit</p>	<p>Perforation or slit</p>  <p>Mount in parallel with perforation or slit</p>	Distance from slit	<p>Closer to slit is higher stress</p>  <p>($l_1 < l_2$)</p>	<p>Away from slit is less stress</p>  <p>($l_1 < l_2$)</p>
	Disadvantage against bending stress	Advantage against bending stress												
Mounting face	<p>Perforation or slit</p>  <p>Break P.C.board with mounted side up.</p>	<p>Perforation or slit</p>  <p>Break P.C.board with mounted side down.</p>												
Chip arrangement (Direction)	<p>Perforation or slit</p>  <p>Mount perpendicularly to perforation or slit</p>	<p>Perforation or slit</p>  <p>Mount in parallel with perforation or slit</p>												
Distance from slit	<p>Closer to slit is higher stress</p>  <p>($l_1 < l_2$)</p>	<p>Away from slit is less stress</p>  <p>($l_1 < l_2$)</p>												

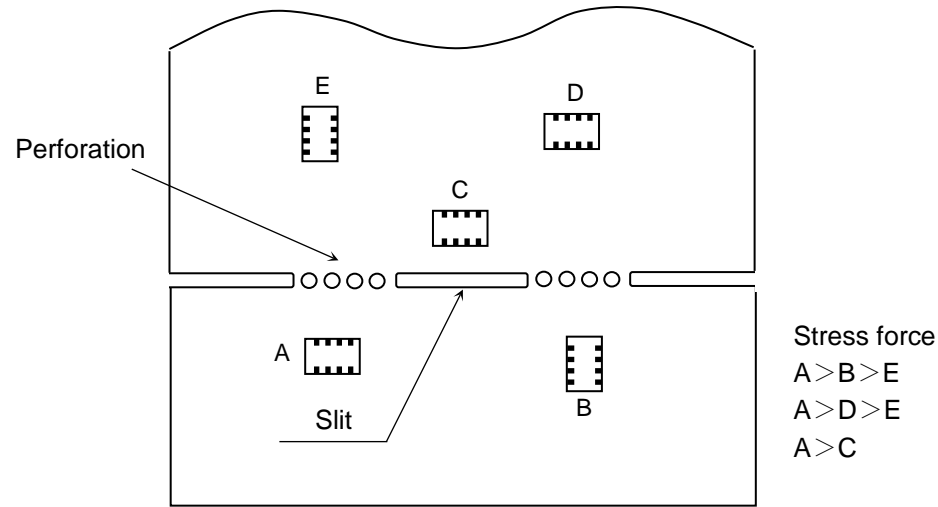
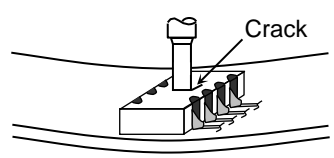
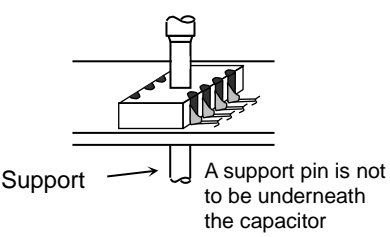
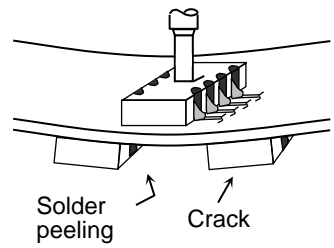
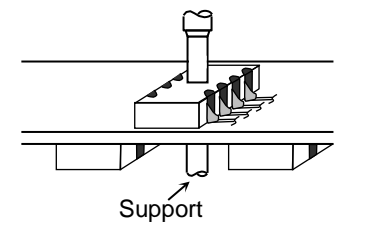
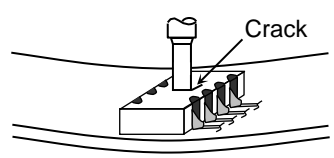
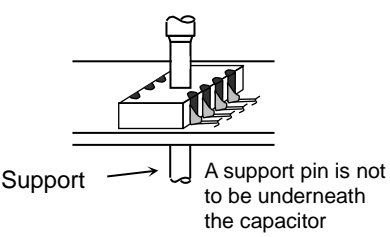
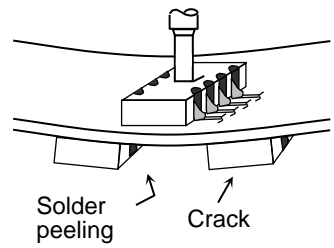
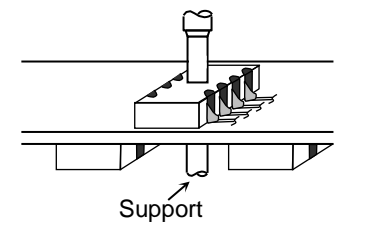
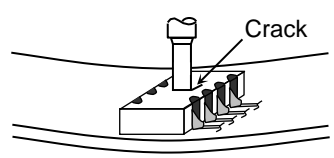
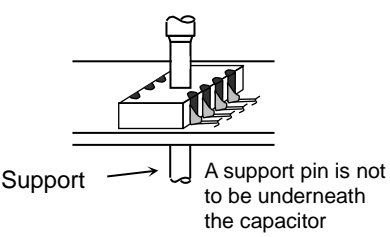
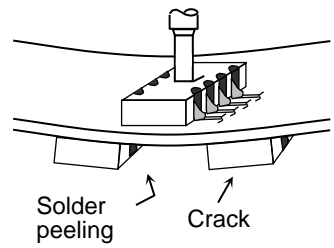
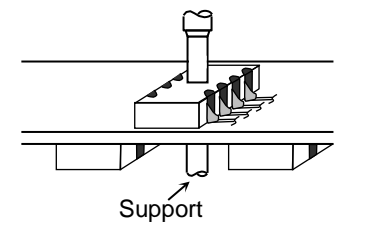
No.	Process	Condition									
3	Designing P.C.board	<p>5) Mechanical stress varies according to location of chip capacitors on the P.C.board.</p>  <p>When dividing printed wiring boards, the intensities of mechanical stress applied to capacitors are different according to each dividing method in the order of : Push-back < Slit < V-groove < Perforation. Therefore consider not only position of capacitors, but also the way of the dividing the printed wiring boards.</p>									
4	Mounting	<p>4-1. Stress from mounting head If the mounting head is adjusted too low, it may induce excessive stress in the chip capacitor to result in cracking. Please take following precautions.</p> <ol style="list-style-type: none"> 1) Adjust the bottom dead center of the mounting head to reach on the P.C.board surface and not press it. 2) Adjust the mounting head pressure to be 1 to 3N of static weight. 3) To minimize the impact energy from mounting head, it is important to provide support from the bottom side of the P.C.board. See following examples. <table border="1" data-bbox="478 1310 1460 1926"> <thead> <tr> <th></th> <th>Not recommended</th> <th>Recommended</th> </tr> </thead> <tbody> <tr> <td>Single-sided mounting</td> <td></td> <td> Support → A support pin is not to be underneath the capacitor</td> </tr> <tr> <td>Double-sides mounting</td> <td></td> <td></td> </tr> </tbody> </table> <p>When the centering jaw is worn out, it may give mechanical impact on the capacitor to cause crack. Please control the close up dimension of the centering jaw and provide sufficient preventive maintenance and replacement of it.</p>		Not recommended	Recommended	Single-sided mounting		 Support → A support pin is not to be underneath the capacitor	Double-sides mounting		
	Not recommended	Recommended									
Single-sided mounting		 Support → A support pin is not to be underneath the capacitor									
Double-sides mounting											

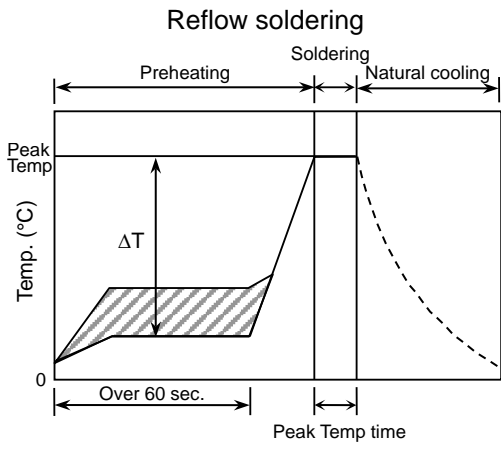
No.	Process	Condition																		
5	Soldering	<p>5-1. Flux selection</p> <p>Flux can seriously affect the performance of capacitors. Confirm the following to select the appropriate flux.</p> <ol style="list-style-type: none"> 1) It is recommended to use a mildly activated rosin flux (less than 0.1wt% chlorine). Strong flux is not recommended. 2) Excessive flux must be avoided. Please provide proper amount of flux. 3) When water-soluble flux is used, enough washing is necessary. <p>5-2. Recommended soldering profile : Reflow method</p> <p>Refer to the following temperature profile at Reflow soldering.</p> <div style="text-align: center;"> <p>Reflow soldering</p>  </div> <p>5-3. Recommended soldering peak temp and peak temp duration for Reflow soldering</p> <p>Pb free solder is recommended, but if Sn-37Pb must be used, refer to below.</p> <table border="1" data-bbox="587 1160 1332 1400"> <thead> <tr> <th rowspan="2" style="text-align: center;">Temp./Duration</th> <th colspan="2" style="text-align: center;">Reflow soldering</th> </tr> <tr> <th style="text-align: center;">Peak temp(°C)</th> <th style="text-align: center;">Duration(sec.)</th> </tr> </thead> <tbody> <tr> <td style="text-align: center;">Solder</td> <td></td> <td></td> </tr> <tr> <td style="text-align: center;">Lead Free Solder</td> <td style="text-align: center;">260 max.</td> <td style="text-align: center;">10 max.</td> </tr> <tr> <td style="text-align: center;">Sn-Pb Solder</td> <td style="text-align: center;">230 max.</td> <td style="text-align: center;">20 max.</td> </tr> </tbody> </table> <p>Recommended solder compositions</p> <p>Lead Free Solder : Sn-3.0Ag-0.5Cu</p> <p>5-4. Avoiding thermal shock</p> <ol style="list-style-type: none"> 1) Preheating condition <table border="1" data-bbox="539 1594 1120 1713"> <thead> <tr> <th style="text-align: center;">Soldering</th> <th style="text-align: center;">Temp. (°C)</th> </tr> </thead> <tbody> <tr> <td style="text-align: center;">Reflow soldering</td> <td style="text-align: center;">$\Delta T \leq 150$</td> </tr> </tbody> </table> 2) Cooling condition <p>Natural cooling using air is recommended. If the chips are dipped into a solvent for cleaning, the temperature difference (ΔT) must be less than 100°C.</p>	Temp./Duration	Reflow soldering		Peak temp(°C)	Duration(sec.)	Solder			Lead Free Solder	260 max.	10 max.	Sn-Pb Solder	230 max.	20 max.	Soldering	Temp. (°C)	Reflow soldering	$\Delta T \leq 150$
Temp./Duration	Reflow soldering																			
	Peak temp(°C)	Duration(sec.)																		
Solder																				
Lead Free Solder	260 max.	10 max.																		
Sn-Pb Solder	230 max.	20 max.																		
Soldering	Temp. (°C)																			
Reflow soldering	$\Delta T \leq 150$																			

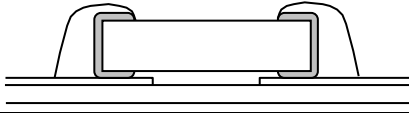
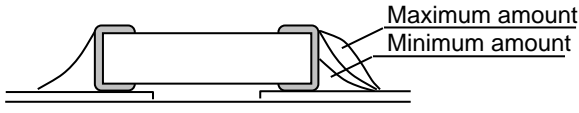
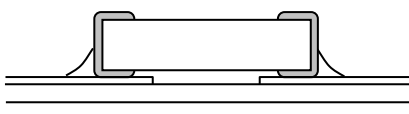
No.	Process	Condition
5	Soldering	<p data-bbox="435 210 699 237">5-5. Amount of solder</p> <p data-bbox="520 246 1461 336">Excessive solder will induce higher tensile force in chip capacitors when temperature changes and it may result in chip cracking. In sufficient solder may detach the capacitors from the P.C.board.</p> <hr/> <div style="display: flex; justify-content: space-between;"> <div data-bbox="496 394 619 456">Excessive solder</div> <div data-bbox="683 394 1094 501">  </div> <div data-bbox="1121 380 1414 470">Higher tensile force in chip capacitors to cause crack</div> </div> <hr/> <div style="display: flex; justify-content: space-between;"> <div data-bbox="496 564 612 591">Adequate</div> <div data-bbox="660 519 1241 636">  </div> </div> <hr/> <div style="display: flex; justify-content: space-between;"> <div data-bbox="496 698 628 761">Insufficient solder</div> <div data-bbox="683 698 1094 792">  </div> <div data-bbox="1121 672 1414 784">Low robustness may cause contact failure or chip capacitors come off the P.C.board.</div> </div> <hr/> <p data-bbox="435 860 647 887">5-6. Sn-Zn solder</p> <p data-bbox="464 896 1155 954">Sn-Zn solder affects product reliability. Please contact TDK in advance when utilize Sn-Zn solder.</p> <p data-bbox="435 990 863 1016">5-7. Countermeasure for tombstone</p> <p data-bbox="464 1025 1449 1209">The misalignment between the mounted positions of the capacitors and the land patterns should be minimized. The tombstone phenomenon may occur especially the capacitors are mounted (in longitudinal direction) in the same direction of the reflow soldering. (Refer to JEITA RCR-2335C Annex A (Informative), Recommendations to prevent the tombstone phenomenon.)</p>

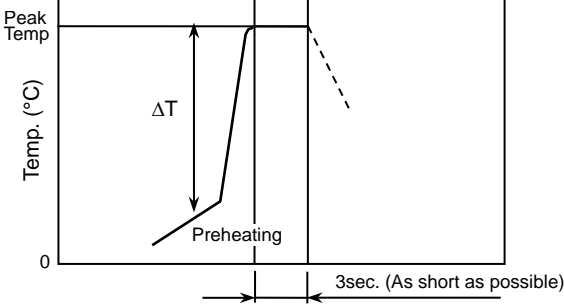
No.	Process	Condition																
6	Solder repairing	<p>Solder repairing is unavoidable, refer to below.</p> <p>6-1. Solder repair by solder iron</p> <p>1) Selection of the soldering iron tip Tip temperature of solder iron varies by its type, P.C.board material and solder land size. The higher the tip temperature, the quicker the operation. However, heat shock may cause a crack in the chip capacitors. Please make sure the tip temp. before soldering and keep the peak temp and time in accordance with following recommended condition.</p> <div style="text-align: center;"> <p>Manual soldering (Solder iron)</p>  </div> <table border="1" style="margin-left: auto; margin-right: auto;"> <thead> <tr> <th colspan="4" style="text-align: center;">Recommended solder iron condition (Sn-Pb Solder and Lead Free Solder)</th> </tr> <tr> <th style="text-align: center;">Temp. (°C)</th> <th style="text-align: center;">Duration (sec.)</th> <th style="text-align: center;">Wattage (W)</th> <th style="text-align: center;">Shape (mm)</th> </tr> </thead> <tbody> <tr> <td style="text-align: center;">300 max.</td> <td style="text-align: center;">3 max.</td> <td style="text-align: center;">20 max.</td> <td style="text-align: center;">ø3.0 max.</td> </tr> </tbody> </table> <p>* Please preheat the chip capacitors with the condition in 6-3 to avoid the thermal shock.</p> <p>2) Direct contact of the soldering iron with ceramic dielectric of chip capacitors may cause crack. Do not touch the ceramic dielectric and the terminations by solder iron.</p> <p>6-2. Avoiding thermal shock</p> <p>Preheating condition</p> <table border="1" style="margin-left: auto; margin-right: auto;"> <thead> <tr> <th style="text-align: center;">Soldering</th> <th style="text-align: center;">Temp. (°C)</th> </tr> </thead> <tbody> <tr> <td style="text-align: center;">Manual soldering</td> <td style="text-align: center;">$\Delta T \leq 150$</td> </tr> </tbody> </table>	Recommended solder iron condition (Sn-Pb Solder and Lead Free Solder)				Temp. (°C)	Duration (sec.)	Wattage (W)	Shape (mm)	300 max.	3 max.	20 max.	ø3.0 max.	Soldering	Temp. (°C)	Manual soldering	$\Delta T \leq 150$
Recommended solder iron condition (Sn-Pb Solder and Lead Free Solder)																		
Temp. (°C)	Duration (sec.)	Wattage (W)	Shape (mm)															
300 max.	3 max.	20 max.	ø3.0 max.															
Soldering	Temp. (°C)																	
Manual soldering	$\Delta T \leq 150$																	

No.	Process	Condition
7	Cleaning	<p>1) If an unsuitable cleaning fluid is used, flux residue or some foreign articles may stick to chip capacitors surface to deteriorate especially the insulation resistance.</p> <p>2) If cleaning condition is not suitable, it may damage the chip capacitors.</p> <p>2)-1. Insufficient washing</p> <p>(1) Terminal electrodes may corrode by Halogen in the flux.</p> <p>(2) Halogen in the flux may adhere on the surface of capacitors, and lower the insulation resistance.</p> <p>(3) Water soluble flux has higher tendency to have above mentioned problems (1) and (2).</p> <p>2)-2. Excessive washing</p> <p>When ultrasonic cleaning is used, excessively high ultrasonic energy output can affect the connection between the ceramic chip capacitor's body and the terminal electrode. To avoid this, following is the recommended condition.</p> <p style="padding-left: 40px;">Power : 20 W/l max. Frequency : 40 kHz max. Washing time : 5 minutes max.</p> <p>2)-3. If the cleaning fluid is contaminated, density of Halogen increases, and it may bring the same result as insufficient cleaning.</p>

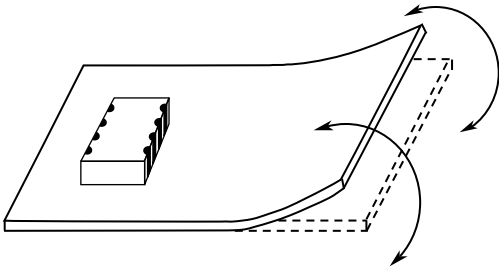
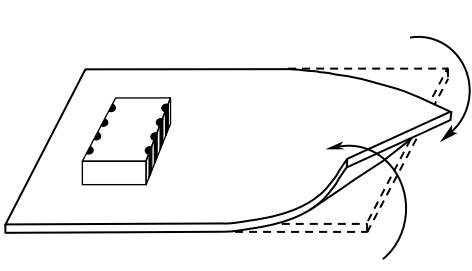
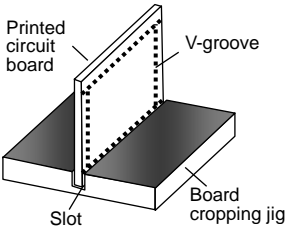
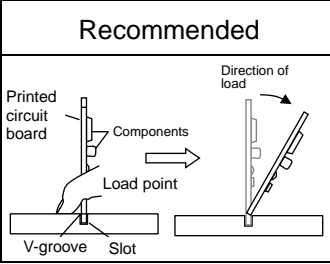
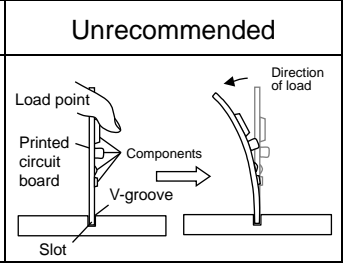
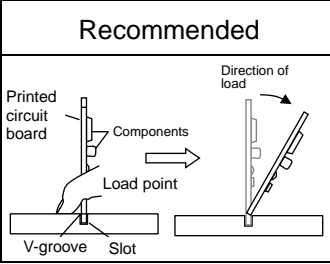
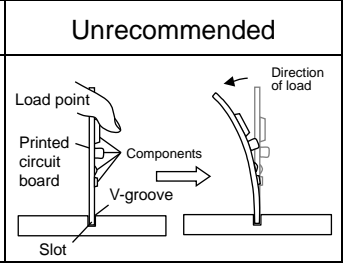
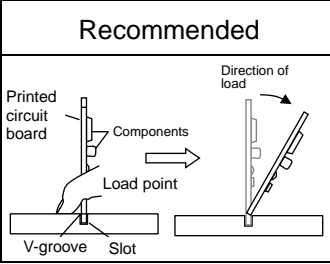
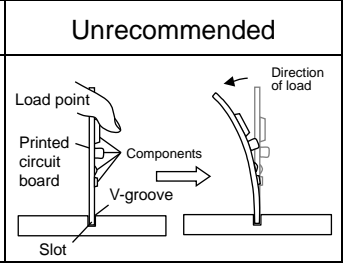
No.	Process	Condition				
8	Coating and molding of the P.C.board	<p>1) When the P.C.board is coated, please verify the quality influence on the product.</p> <p>2) Please verify carefully that there is no harmful decomposing or reaction gas emission during curing which may damage the chip capacitors.</p> <p>3) Please verify the curing temperature.</p>				
9	Handling after chip mounted  Caution	<p>1) Please pay attention not to bend or distort the P.C.board after soldering in handling otherwise the chip capacitors may crack.</p> <div style="display: flex; justify-content: space-around; align-items: center;"> <div style="text-align: center;"> <p>Bend</p>  </div> <div style="text-align: center;"> <p>Twist</p>  </div> </div> <p>2) Printed circuit board cropping should not be carried out by hand, but by using the proper tooling. Printed circuit board cropping should be carried out using a board cropping jig as shown in the following figure or a board cropping apparatus to prevent inducing mechanical stress on the board.</p> <p>(1) Example of a board cropping jig</p> <p>Recommended example: The board should be pushed from the back side, close to the cropping jig so that the board is not bent and the stress applied to the capacitor is compressive.</p> <p>Unrecommended example: If the pushing point is far from the cropping jig and the pushing direction is from the front side of the board, large tensile stress is applied to the capacitor, which may cause cracks.</p> <div style="display: flex; justify-content: space-around; align-items: flex-start;"> <div style="text-align: center;"> <p>Outline of jig</p>  </div> <table border="1" style="width: 100%; border-collapse: collapse;"> <thead> <tr> <th style="width: 50%; text-align: center;">Recommended</th> <th style="width: 50%; text-align: center;">Unrecommended</th> </tr> </thead> <tbody> <tr> <td style="text-align: center;">  </td> <td style="text-align: center;">  </td> </tr> </tbody> </table> </div>	Recommended	Unrecommended		
Recommended	Unrecommended					
						

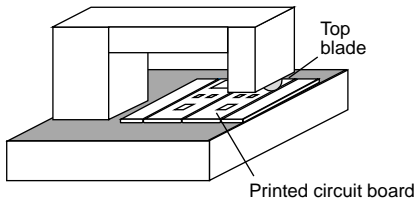
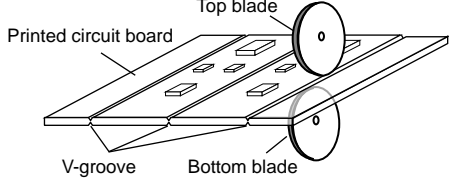
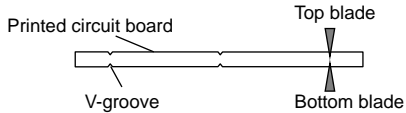
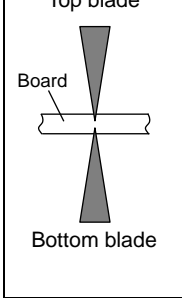
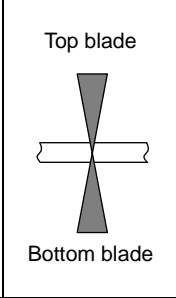
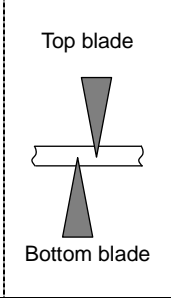
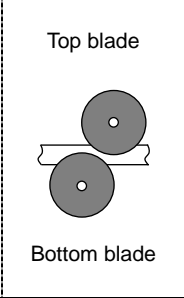
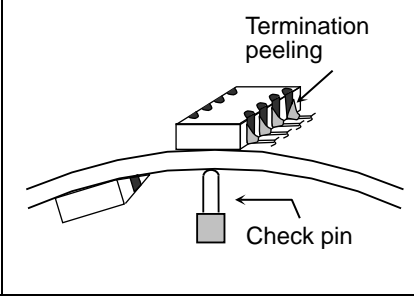
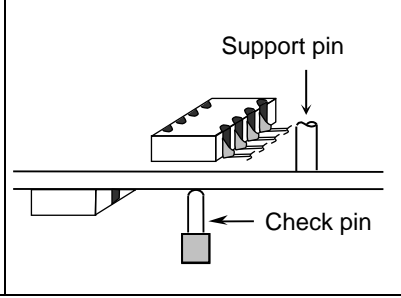
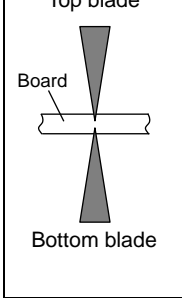
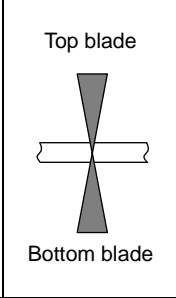
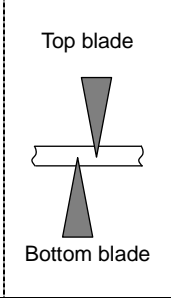
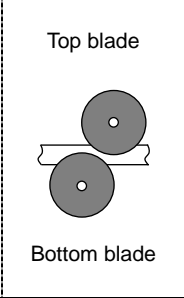
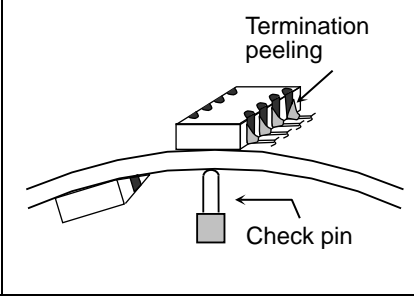
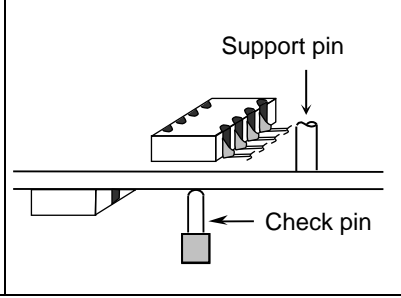
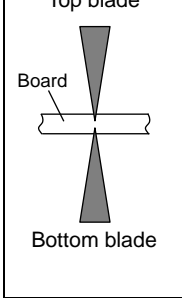
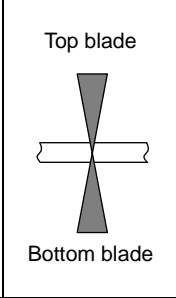
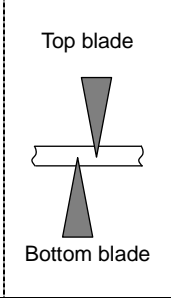
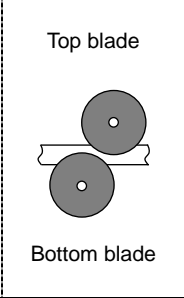
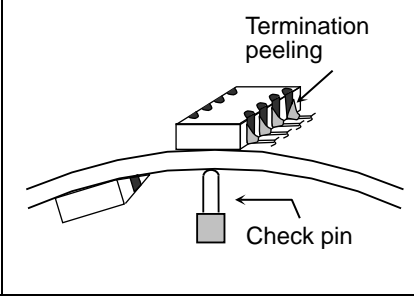
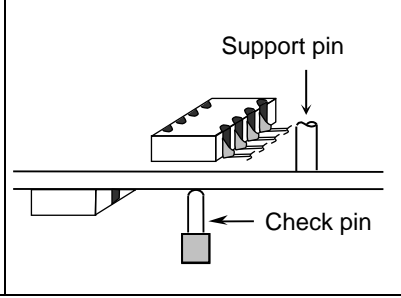
No.	Process	Condition																	
9	Handling after chip mounted  Caution	<p>(2) Example of a board cropping machine</p> <p>An outline of a printed circuit board cropping machine is shown below. The top and bottom blades are aligned with one another along the lines with the V-grooves on printed circuit board when cropping the board.</p> <p>Unrecommended example: Misalignment of blade position between top and bottom, right and left, or front and rear blades may cause a crack in the capacitor.</p> <div style="display: flex; justify-content: space-around;"> <div data-bbox="539 504 954 757"> <p>Outline of machine</p>  </div> <div data-bbox="986 504 1436 739"> <p>Principle of operation</p>  </div> </div> <div style="text-align: center; margin-top: 20px;"> <p>Cross-section diagram</p>  </div> <table border="1" style="width: 100%; margin-top: 20px; border-collapse: collapse;"> <thead> <tr> <th data-bbox="646 981 826 1070" rowspan="2">Recommended</th> <th colspan="3" data-bbox="826 981 1356 1025">Unrecommended</th> </tr> <tr> <th data-bbox="826 1025 1002 1115">Top-bottom misalignment</th> <th data-bbox="1002 1025 1173 1115">Left-right misalignment</th> <th data-bbox="1173 1025 1356 1115">Front-rear misalignment</th> </tr> </thead> <tbody> <tr> <td data-bbox="646 1115 826 1411">  </td> <td data-bbox="826 1115 1002 1411">  </td> <td data-bbox="1002 1115 1173 1411">  </td> <td data-bbox="1173 1115 1356 1411">  </td> </tr> </tbody> </table> <p>3) When functional check of the P.C.board is performed, check pin pressure tends to be adjusted higher for fear of loose contact. But if the pressure is excessive and bend the P.C.board, it may crack the chip capacitors or peel the terminations off. Please adjust the check pins not to bend the P.C.board.</p> <table border="1" style="width: 100%; margin-top: 20px; border-collapse: collapse;"> <thead> <tr> <th data-bbox="478 1653 619 1720">Item</th> <th data-bbox="619 1653 1034 1720">Not recommended</th> <th data-bbox="1034 1653 1436 1720">Recommended</th> </tr> </thead> <tbody> <tr> <td data-bbox="478 1720 619 2016">Board bending</td> <td data-bbox="619 1720 1034 2016">  </td> <td data-bbox="1034 1720 1436 2016">  </td> </tr> </tbody> </table>	Recommended	Unrecommended			Top-bottom misalignment	Left-right misalignment	Front-rear misalignment					Item	Not recommended	Recommended	Board bending		
Recommended	Unrecommended																		
	Top-bottom misalignment	Left-right misalignment	Front-rear misalignment																
																			
Item	Not recommended	Recommended																	
Board bending																			

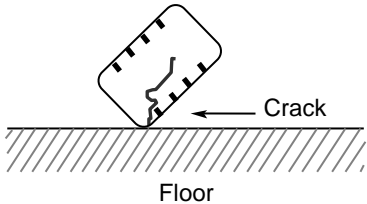
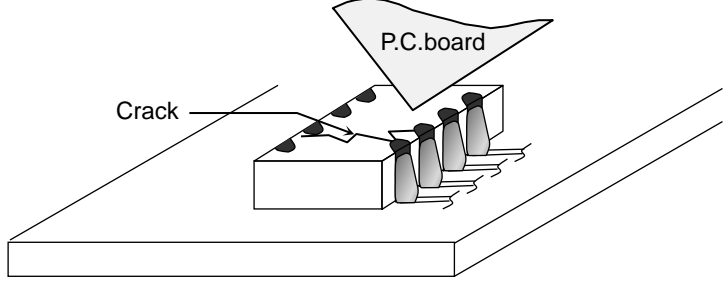
No.	Process	Condition
10	Handling of loose chip capacitors	<p>1) If dropped the chip capacitors may crack. Once dropped do not use it. Especially, the large case sized chip capacitors are tendency to have cracks easily, so please handle with care.</p>  <p>2) Piling the P.C.board after mounting for storage or handling, the corner of the P.C. board may hit the chip capacitors of another board to cause crack.</p> 
11	Capacitance aging	The capacitors have aging in the capacitance. They may not be used in precision time constant circuit. In case of the time constant circuit, the evaluation should be done well.
12	Estimated life and estimated failure rate of capacitors	<p>As per the estimated life and the estimated failure rate depend on the temperature and the voltage. This can be calculated by the equation described in JEITA RCR-2335C Annex F (Informative) Calculation of the estimated lifetime and the estimated failure rate (Voltage acceleration coefficient : 3 multiplication rule, Temperature acceleration coefficient : 10°C rule)</p> <p>The failure rate can be decreased by reducing the temperature and the voltage but they will not be guaranteed.</p>

No.	Process	Condition
13	Caution during operation of equipment	<p>1) A capacitor shall not be touched directly with bare hands during operation in order to avoid electric shock. Electric energy held by the capacitor may be discharged through the human body when touched with a bare hand. Even when the equipment is off, a capacitor may stay charged. The capacitor should be handled after being completely discharged using a resistor.</p> <p>2) The terminals of a capacitor shall not be short-circuited by any accidental contact with a conductive object. A capacitor shall not be exposed to a conductive liquid such as an acid or alkali solution. A conductive object or liquid, such as acid and alkali, between the terminals may lead to the breakdown of a capacitor due to short circuit</p> <p>3) Confirm that the environment to which the equipment will be exposed during transportation and operation meets the specified conditions. Do not to use the equipment in the following environments.</p> <p>(1) Environment where a capacitor is splattered with water or oil (2) Environment where a capacitor is exposed to direct sunlight (3) Environment where a capacitor is exposed to Ozone, ultraviolet rays or radiation (4) Environment where a capacitor exposed to corrosive gas(e.g. hydrogen sulfide, sulfur dioxide, chlorine. ammonia gas etc.) (5) Environment where a capacitor exposed to vibration or mechanical shock exceeding the specified limits. (6) Atmosphere change with causes condensation</p>
14	Others  Caution	<p>The products listed on this specification sheet are intended for use in general electronic equipment (AV equipment, telecommunications equipment, home appliances, amusement equipment, computer equipment, personal equipment, office equipment, measurement equipment, industrial robots) under a normal operation and use condition.</p> <p>The products are not designed or warranted to meet the requirements of the applications listed below, whose performance and/or quality require a more stringent level of safety or reliability, or whose failure, malfunction or trouble could cause serious damage to society, person or property. Please understand that we are not responsible for any damage or liability caused by use of the products in any of the applications below or for any other use exceeding the range or conditions set forth in this specification sheet. If you intend to use the products in the applications listed below or if you have special requirements exceeding the range or conditions set forth in this specification, please contact us.</p> <p>(1)Aerospace/Aviation equipment (2)Transportation equipment (cars, electric trains, ships, etc.) (3)Medical equipment (Excepting Pharmaceutical Affairs Law classification Class1, 2) (4)Power-generation control equipment (5)Atomic energy-related equipment (6)Seabed equipment (7)Transportation control equipment (8)Public information-processing equipment (9)Military equipment (10)Electric heating apparatus, burning equipment (11)Disaster prevention/crime prevention equipment (12)Safety equipment (13)Other-applications that are not considered general purpose applications.</p> <p>When designing your equipment even for general-purpose applications, you are kindly requested to take into consideration securing protection circuit/device or providing backup circuits in your equipment.</p>

12. TAPE PACKAGING SPECIFICATION

1. CONSTRUCTION AND DIMENSION OF TAPING

1-1. Dimensions of carrier tape

Dimensions of plastic tape shall be according to Appendix 2.

1-2. Trailer and leader of carrier tape

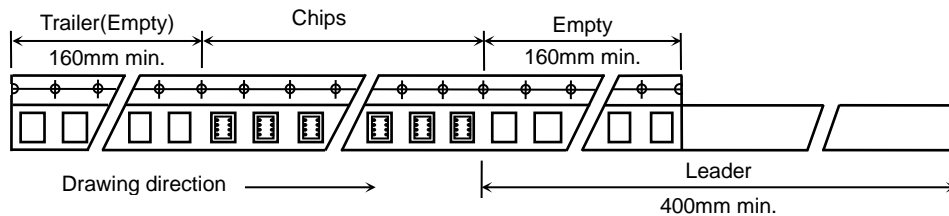

1-3. Dimensions of taping reel

Dimensions of $\varnothing 178\text{mm}$ diameter reel shall be according to Appendix 3.

Dimensions of $\varnothing 330\text{mm}$ diameter reel shall be according to Appendix 4.

1-4. Structure of taping

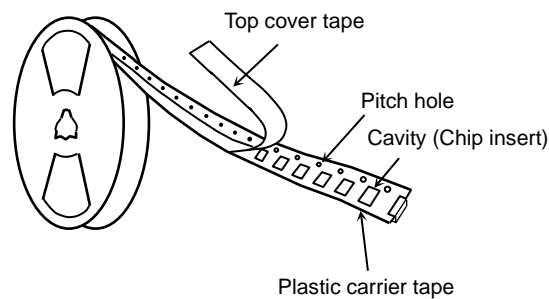

2. CHIP QUANTITY

Please refer to detail page on TDK web.

3. PERFORMANCE SPECIFICATIONS

3-1. Peel back strength (top cover tape)

$$0.05\text{N} < \text{Peeling strength} < 0.7\text{N}$$

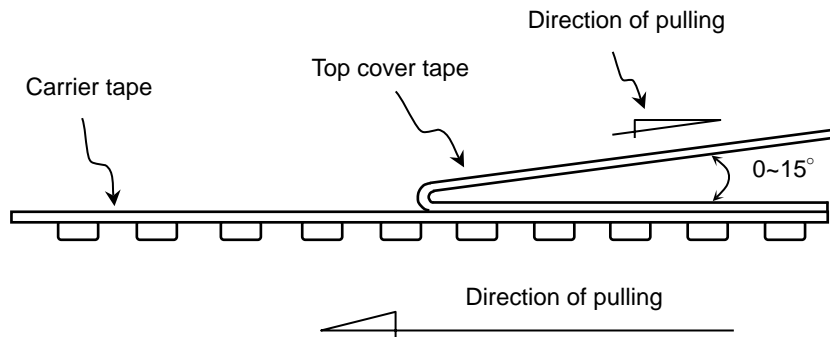

3-2. Carrier tape shall be flexible enough to be wound around a minimum radius of 30mm with components in tape.

3-3. The missing of components shall be less than 0.1%

3-4. Components shall not stick to fixing tape.

3-5. When removing the cover tape, there shall not be difficulties by unfitting clearance gap, burrs and crushes of cavities. Also the sprocket holes shall not be covered by absorbing dust into the suction nozzle.

Appendix 2

Plastic tape

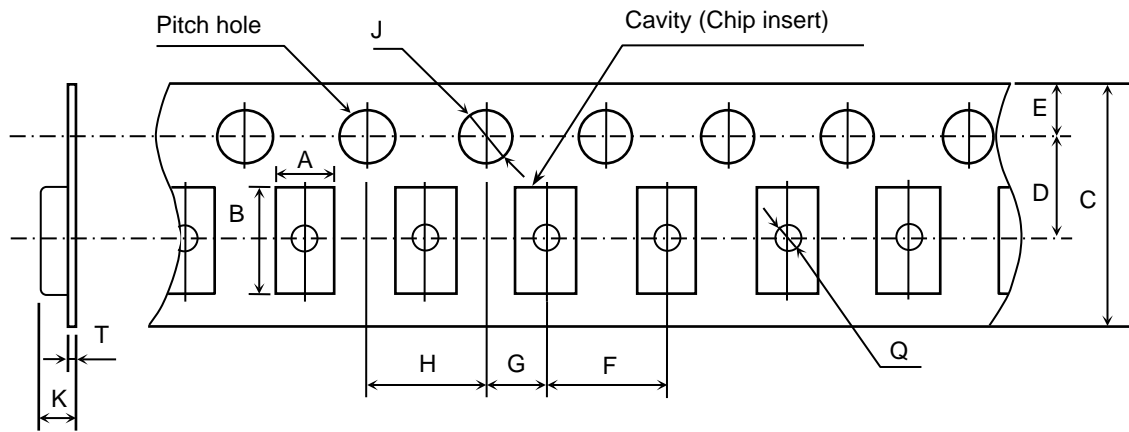

(Unit: mm)

Symbol	A	B	C	D	E	F
Dimension	(1.10)	(1.90)	8.00±0.30	3.50±0.05	1.75±0.10	4.00±0.10
Symbol	G	H	J	K	T	Q
Dimension	2.00±0.05	4.00±0.10	∅ 1.50 $\begin{matrix} +0.10 \\ 0 \end{matrix}$	2.50 max.	0.30 max.	∅ 0.50 min.

() Reference value.

Appendix 3

Dimensions of reel (Material : Polystyrene)

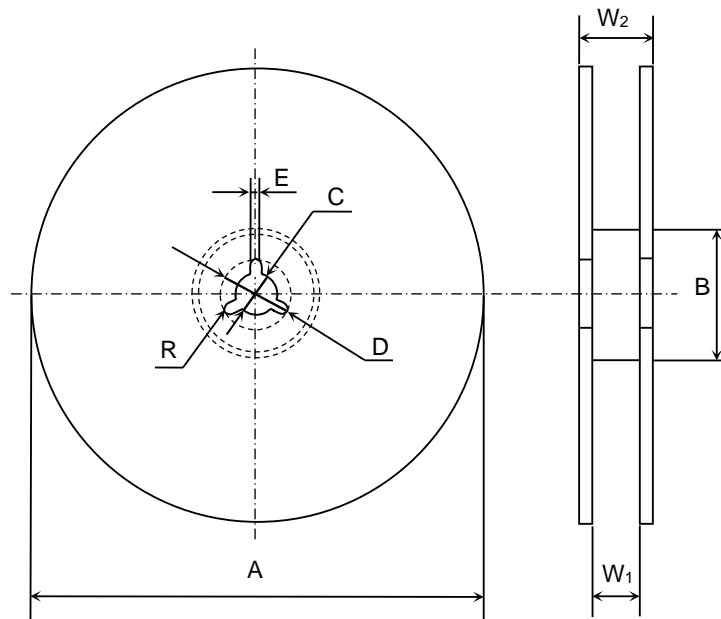

(Unit: mm)

Symbol	A	B	C	D	E	W ₁
Dimension	$\varnothing 178 \pm 2.0$	$\varnothing 60 \pm 2.0$	$\varnothing 13 \pm 0.5$	$\varnothing 21 \pm 0.8$	2.0 ± 0.5	9.0 ± 0.3
Symbol	W ₂	R				
Dimension	13.0 ± 1.4	1.0				

Appendix 4

Dimensions of reel (Material : Polystyrene)

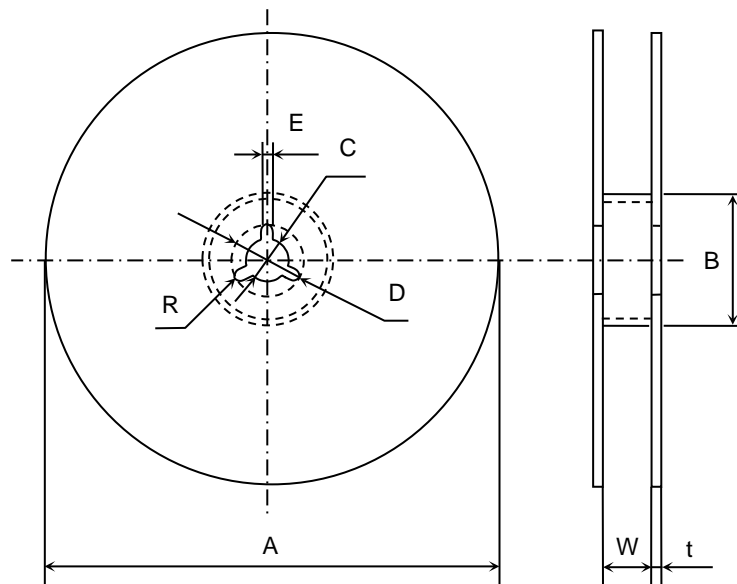

(Unit: mm)

Symbol	A	B	C	D	E	W
Dimension	$\varnothing 382 \text{ max.}$ (Nominal $\varnothing 330$)	$\varnothing 50 \text{ min.}$	$\varnothing 13 \pm 0.5$	$\varnothing 21 \pm 0.8$	2.0 ± 0.5	10.0 ± 1.5
Symbol	t	R				
Dimension	2.0 ± 0.5	1.0				